



HAL
open science

Microbial Influenced Corrosion of passive alloys in natural or industrial waters and test methodology.

D. Feron

► **To cite this version:**

D. Feron. Microbial Influenced Corrosion of passive alloys in natural or industrial waters and test methodology.. FRC-CORR2017 - Fukushima Research Conference on corrosion prediction and mitigation for key components of Fukushima Daiichi NPS, Nov 2017, Sendai, Japan. cea-02417241

HAL Id: cea-02417241

<https://cea.hal.science/cea-02417241v1>

Submitted on 18 Dec 2019

HAL is a multi-disciplinary open access archive for the deposit and dissemination of scientific research documents, whether they are published or not. The documents may come from teaching and research institutions in France or abroad, or from public or private research centers.

L'archive ouverte pluridisciplinaire **HAL**, est destinée au dépôt et à la diffusion de documents scientifiques de niveau recherche, publiés ou non, émanant des établissements d'enseignement et de recherche français ou étrangers, des laboratoires publics ou privés.



MICROBIAL INFLUENCED CORROSION

OF PASSIVE ALLOYS IN NATURAL OR INDUSTRIAL WATERS AND TEST METHODOLOGY.

| Damien Féron, CEA-Den, Université Paris-Saclay, Gif-sur-Yvette, France

Fukushima Research Conference on “corrosion prediction and mitigation for key components of Fukushima Daiichi NPS”, FRC-CORR2017
Fukushima Prefecture - November 27-28, 2017

Background

MIC & biofilms
MIC, bacteria & radiation

Passive alloys

Aerobic conditions

Seawater, natural waters, aerated soils

Anaerobic environments

Sulfur Reducing Bacteria (SRBs), de-aerated environments

Mixed conditions

Scenarios / natural & industrial environments

Conclusion

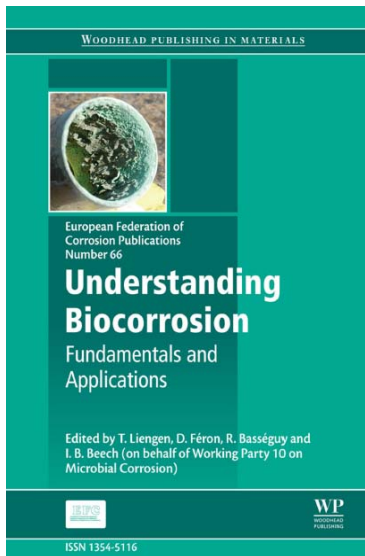

BACKGROUND

MIC & BIOFILMS

FROM MATERIALS TO CORROSION

cea den

MICROBIAL INFLUENCED CORROSION

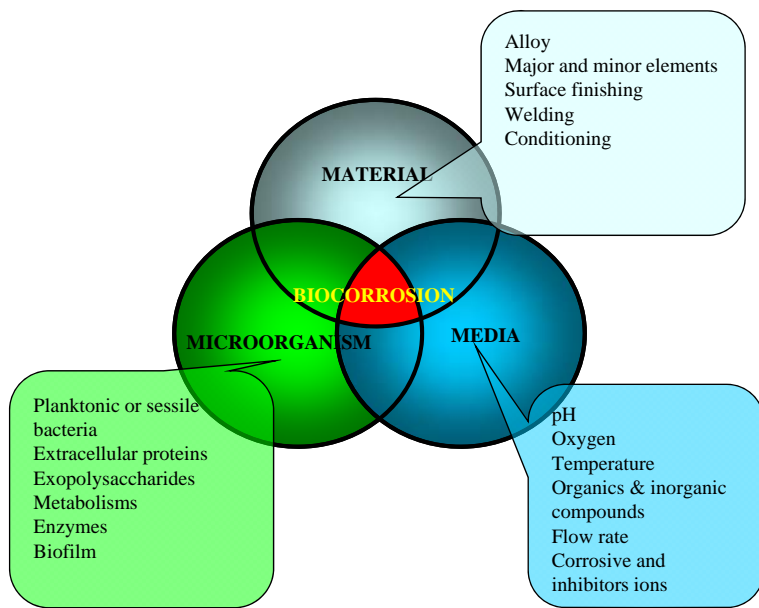

Materials

- Steels
- Passive alloys
- Stainless steels
- Nickel alloys
- Titanium

Media

- Aerobic/Anaerobic
- pH

Micro-organisms

- Contamination

Microbial corrosion
Interactions Material / Media / Microorganisms

Biofilm Heterogeneity



Parameter	Extreme values	Examples
Temperature	From -12°C to +115°C	Cold salt water Hot submarine springs
pH	Very acid (0) to very basic (13)	<i>Thiobacillus ferrooxidans</i> <i>Plectonema nostocorum</i>
SALINITY	Pure water Saturated solutions	Bacteria in de-mineralised waters Bacteria in the Dead Sea
REDOX POTENTIAL	All the water stability domain	Bacteria growth on polarised electrodes
HYDROSTATIC PRESSURE	< 0.01 bar > 1,400 bar	Bacteria in vacuum systems "Barophilic" bacteria in large marine trenches
SURFACES	All surfaces and interfaces	Metals, glasses, plastics, etc. Hydrocarbon/water, etc.
RADIATIONS	Growth on the UV lamp quartz Growth on radioactive sources (>400 krd)	

Domains where biofilms have been found

Biofilm

- Interface between alloy & media
- Found « everywhere »
- Complex
- Heterogeneous
- Large evolution (4 dimensions)

Biofilms & corrosion in a mixed environment

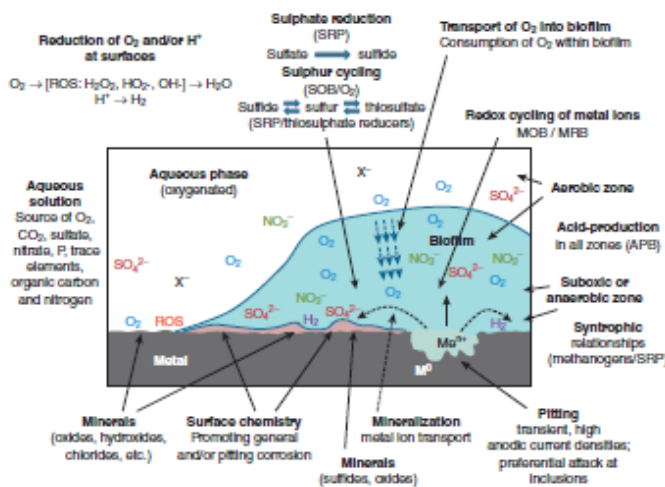

Figure 2.2 Schematic of prominent aspects and processes pertinent to biocorrosion in a mixed aerobic and anoxic environment; ROS (reactive oxygen species); SRP (sulphate-reducing prokaryotes); SOB (sulphur-oxidizing bacteria); MOB (metal-oxidizing bacteria); MRB (metal-reducing bacteria); APB (acid-producing bacteria).

1- Catalysis of cathodic reaction

2-Electrochemical cells

The concept of electroactive biofilms comes from bacterial fuel cells

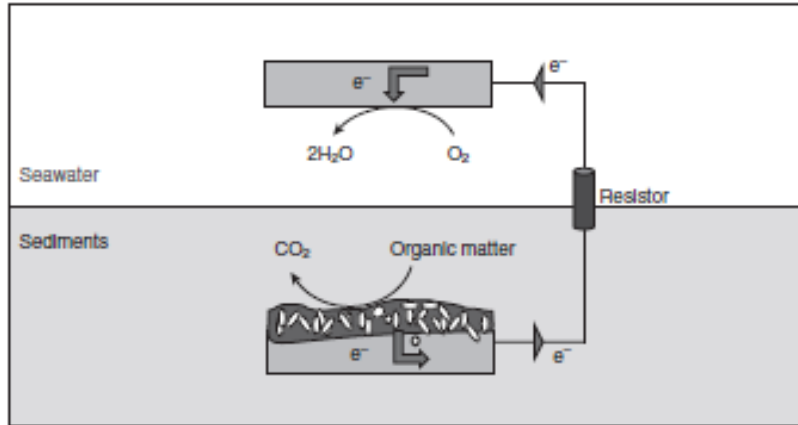

Figure 5.2 Benthic cell = first proof that bacteria are able to exchange electrons with a conductive material. Oxidation of organic matter from sediment at the anode and reduction of dissolved oxygen from seawater at the cathode.

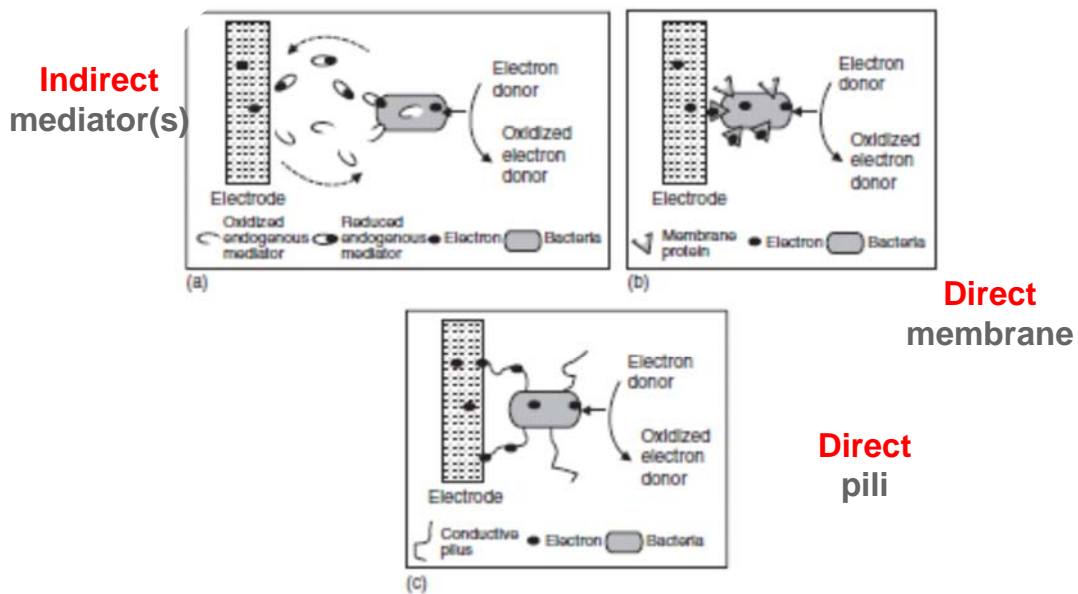

Figure 5.3 The three types of interactions between electroactive bacteria and conductive materials: (a) via endogenous mediators, (b) via membrane redox proteins and (c) via conductive pili.

Electron transfert between conductive surface and bacteria

Electron acceptor : increase of the cathodic reaction kinetic
 Electron donor: cathodic protection

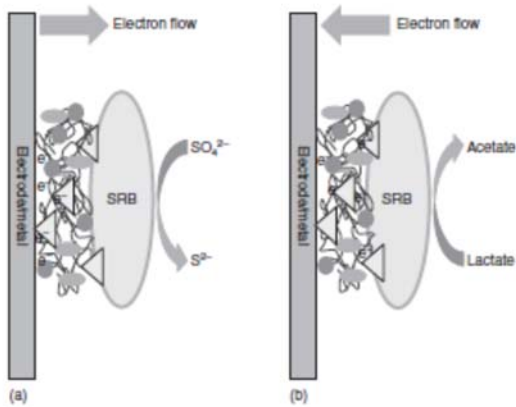

Figure 4.6 Direct and reverse electron flow between SRBs and electrode/metal surface: (a) electron flow from the electrode to the cell; (b) electron flow from the cell to the electrode.

The double aspects of SRBs

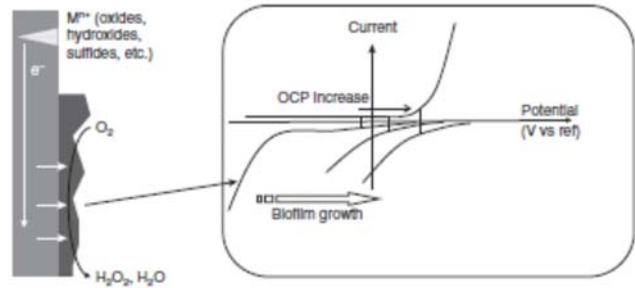
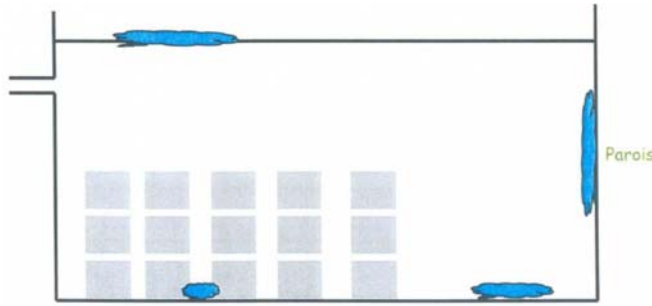

Figure 5.9 Schematic representation of how biofilm, grown on a stainless steel surface, modifies the cathodic branch and its consequence on the open circuit potential (OCP) of the sample.

Effect of aerobic biofilms

BACKGROUND

MIC, BACTERIA & RADIATION



Areas where biofilm have been found in spent fuel ponds

G. Galès, PhD Thesis, 2004, Université d'Aix-Marseille

- Biofilms observed in extreme conditions (high radioactive levels, very low nutrient concentrations)
- Other reports in USA (Savannah River) and in Spain
- Autotrophic population able to oxidize H_2 as energy source, using O_2 as electron acceptor and CO_2 as carbon source (*Ralstonia sp.* & *Burkholderia sp.*)
- High potentials up to +400 mV/SCE observed

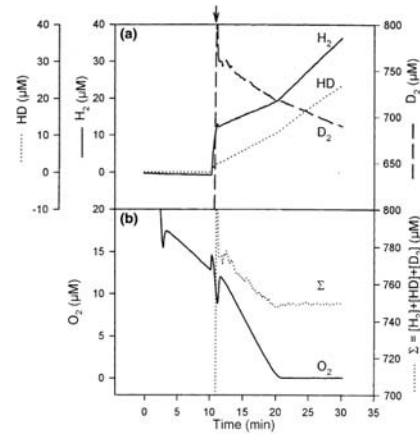

Fig. 2. Evidence of connections between hydrogenase activity and hydrogen/oxygen uptake in autotrophic conditions for *Ralstonia sp.* GGLH002.

G. Galès & Al., FEMS microbiology letters, 240 (2004) 155-162

Microbial activity and biofilms on irradiated spent nuclear fuel cladding

- SRB activity has been found on Magnox sludge from corroding magnesium clad fuel elements
C.R. Gregson & Al., JNM 412 (2011) 145-156
- Microbial biofilm growth experienced in laboratory long term tests on irradiated stainless steel SNF cladding.
- Various bacteria, including SRBs, can survive with a total absorbed dose of $3,2 \cdot 10^3$ Gy.

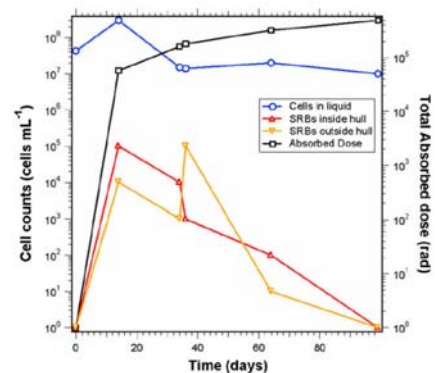
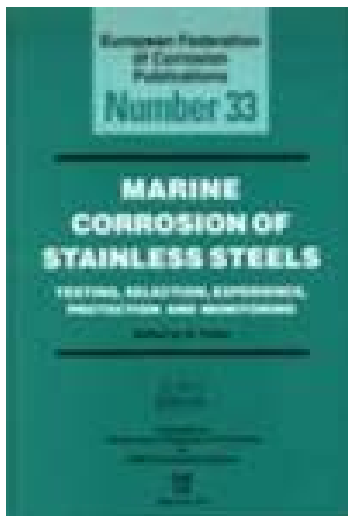
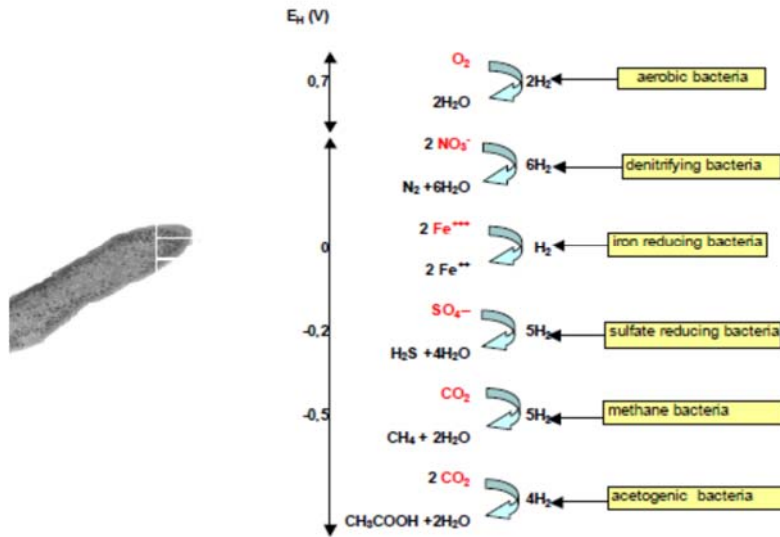

Fig. 3. Cell count versus time for absorbed dose for both microbes in media and sulfate-reducing bacteria collected from a biofilm on the cladding segment surface.

D.F. Bruhn & al., JNM 384 (2009) 140-145

Under irradiation, hydrogen is produced by water radiolysis and may be used by bacteria to reduce some oxidant

During the microbial oxidation of energy sources, microbes preferentially used electron acceptors in a particular order



PASSIVE ALLOYS

AEROBIC CONDITIONS

NATURAL AERATED ENVIRONMENTS

Evolution of the free corrosion potential of S31254 stainless steel samples immersed in the Seine river

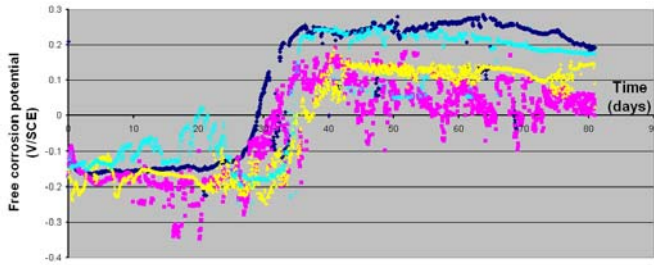

SEA WATER
Free corrosion potential evolution of 254 SMO stainless steel coupons in natural seawaters

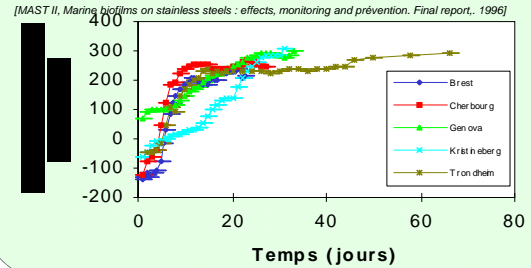

In aerated natural waters, the free corrosion potential on stainless steels increases with exposure time. This evolution is linked to the biofilm formation.

In aerated natural waters, the free corrosion potential on passive alloys increases with exposure time. This evolution is linked to the biofilm formation.

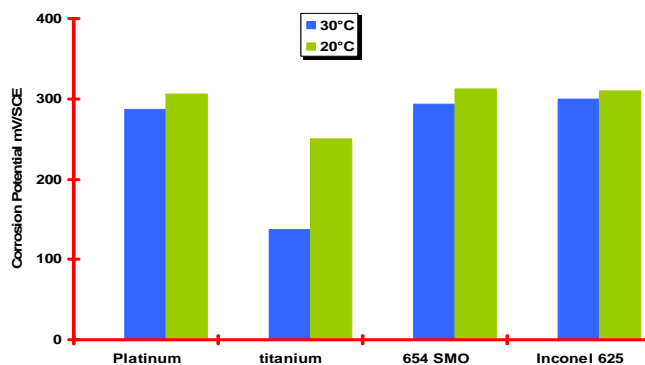

Corrosion potentials observed after 30 days in natural sea water.

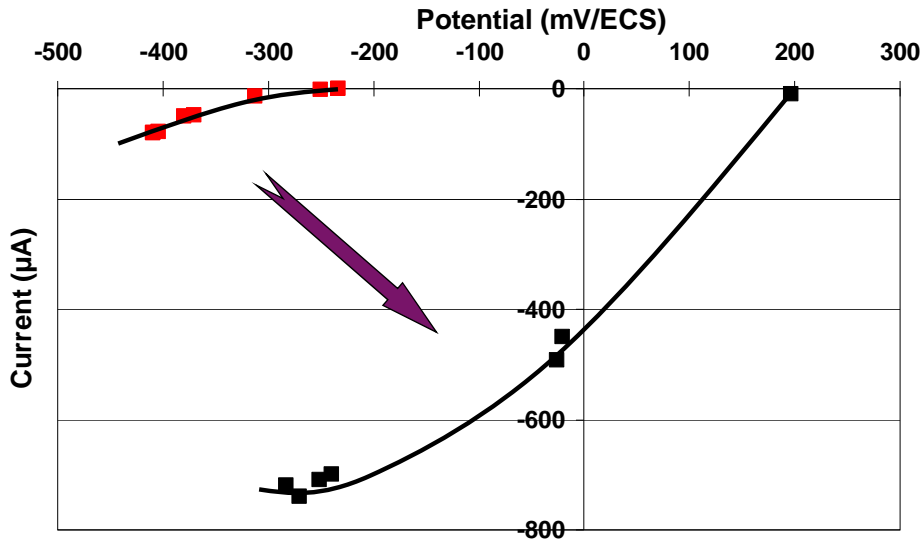

A. Bergel, D. Féron, A. Mollica
Electrochem. Comm. 7 (2005) 900 - 904

Biofilm formed in seawater on stainless steel at constant potential -0.2 V/SCE
 → Current densities up to 1.3 A/m², with [O₂] = 0.24 mM

International Round Robin Tests

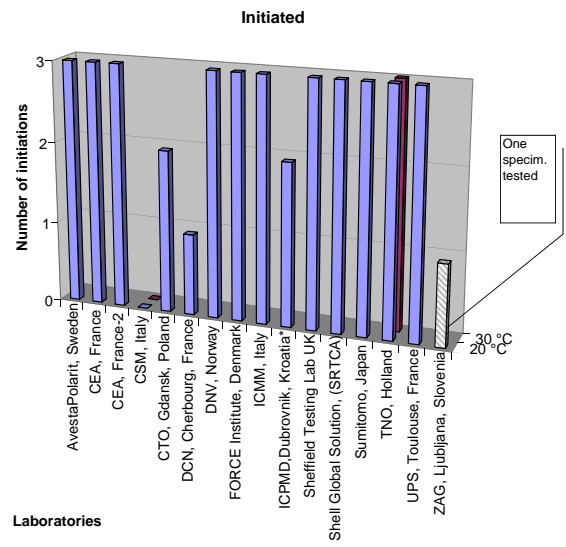
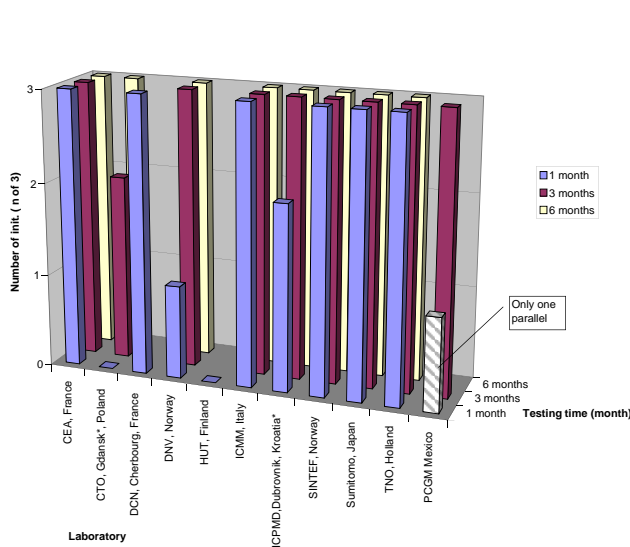

Natural seawater: 74% of the specimens are corroded - 1 month of exposure

Biosynthetic seawater (glucose oxydase addition) at 20°C: 91% after only 5 days

- ⇒ good reproduction and acceleration of the MIC
- ⇒ proposal of an ISO standard by TC156

Influence of the concentrations of chloride on the pitting behavior of 304 & 316 stainless steels

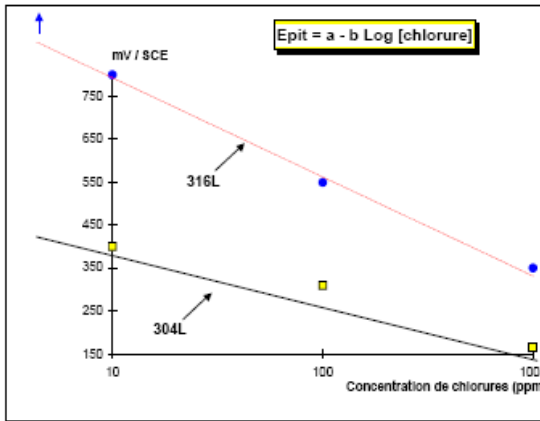

Pitting potential

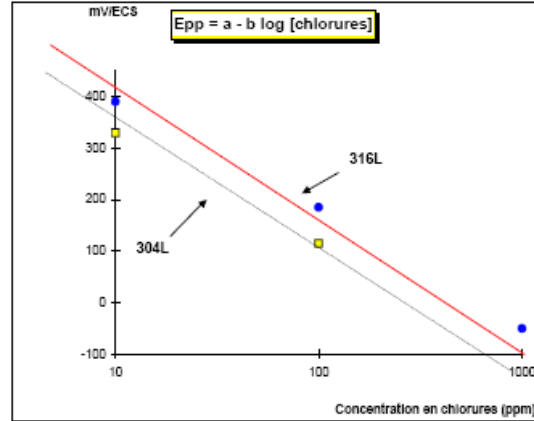

Repassivation potential

Electroactive biofilms (bacteria) may increase the corrosion potential above the pitting potential or above the repassivation potential, leading respectively to pit initiation or propagation

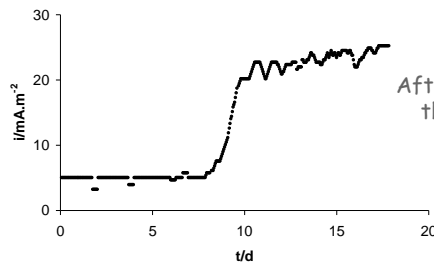

After 8 days in the sea, the current of the biofuel cell reaches 23 $mA.m^2$.

=> Biofuel cell

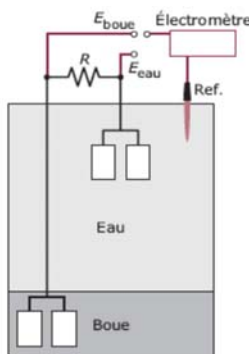

Stainless steel electrodes (0.12 m^2) located in aerated seawater and in the mud

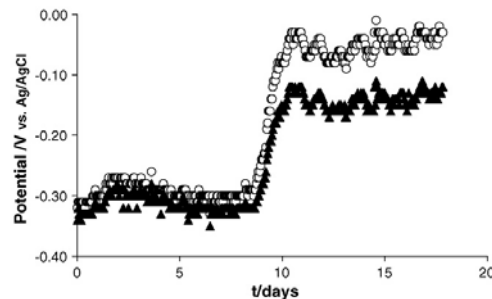

Potential of the cathode lower than 0.0mV/Ag.AgCl instead of +300mV/Ag.AgCl (free corrosion potential)

=> Cathodic protection

Summary

- Increase of the free corrosion potential of passive alloys is linked to the formation of a biofilm
 - Biocatalysis of the cathodic reaction by the biofilm (EA biofilm)
- This may lead to initiation and then propagation of the pits or crevice corrosion
- A methodology based on enzyme mechanisms may help for the choice of an alloy or for the determination of the localized corrosion risk for an alloy already in place

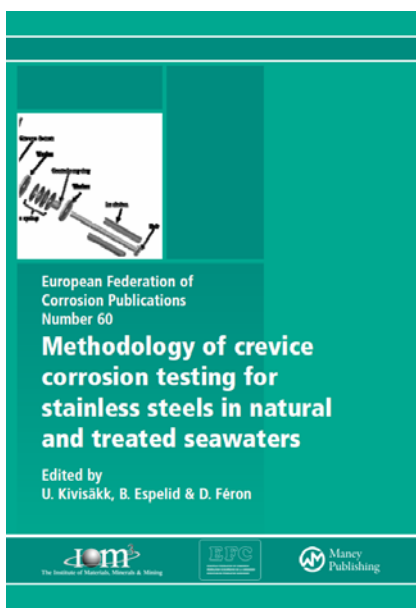

PASSIVE ALLOYS

ANAEROBIC CONDITIONS

SRB versus SULPHIDE ?

Investigations in anaerobic environments (sulphate reducing bacteria) based on the **breakdown potentials** (crevice corrosion / pitting potentials) of passive alloys (stainless steels)

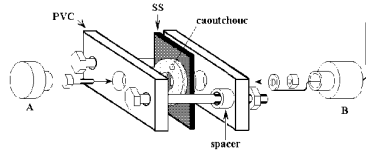

Crevice former utilised for the tests

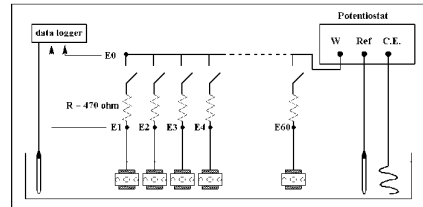

Connection of SS samples to a potentiostat and to a data logger.

Cumulative distribution of the breakdown potentials measured on, at least, 10 similar samples

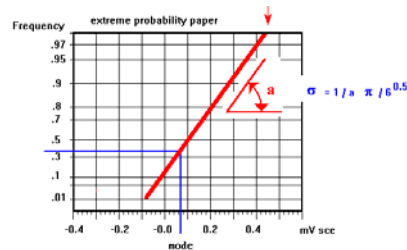

Evolution of breakdown potentials with and without SRBs

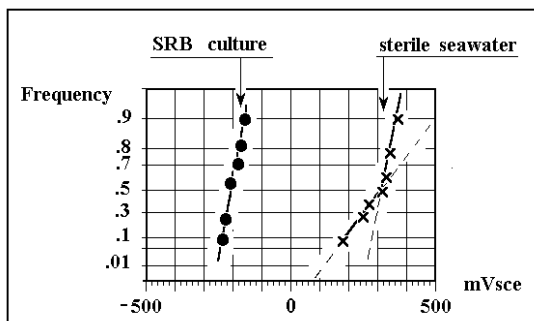

Cumulative distributions of breakdown potentials for 316L (EN 1.4404) in SRB culture and in aerated sterile seawater

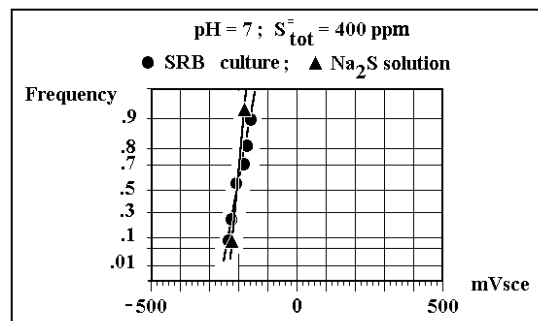

Cumulative distributions of breakdown potentials for 316L (EN 1.4404) in SRB culture and in de-aerated seawater added with Na₂S

➤ Sulphides added as Na₂S simulate the effect of SRBs on the breakdown potential of stainless steels

316L stainless steel (EN 1.4404)

Sterile conditions

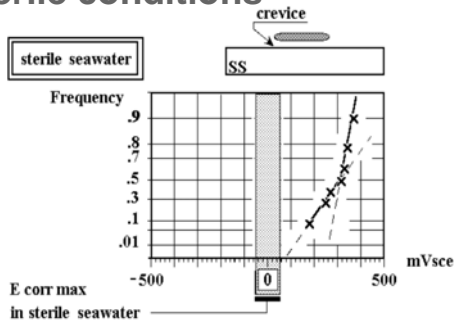

Aerobic conditions

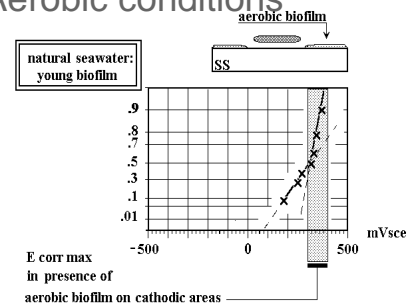

Anaerobic conditions

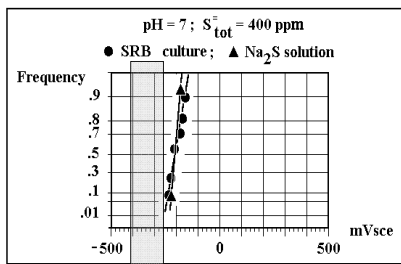

Test methodology to simulate of a biofilm with aerobic and anaerobic areas

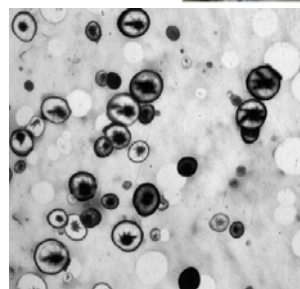
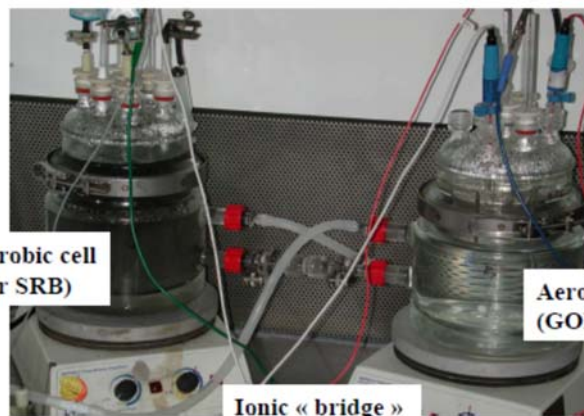
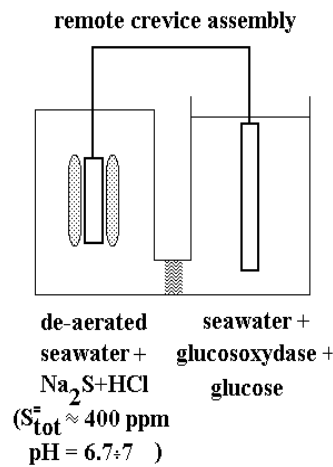

Sulphides under biofilms

1- Electroactive biofilms can be formed and developed even under irradiation.

2- Aerobic biofilms increase the rate of the cathodic reaction on passive alloys (stainless steels, nickel based alloys, titanium,...)

The effect of aerobic bacteria can be simulated by adding glucose oxidase and glucose to sterile seawater.

3- SRBs biofilms lead to decrease breakdown potentials of passive alloys.

The effect of anaerobic bacteria can be simulated by adding Na_2S to sterile de-aerated seawater.

4- The settlement of aerobic bacteria and the presence of active SRB bacteria act in synergistic way as promoters of corrosion onset:

- cathodic reaction(s) accelerated by the aerobic biofilm.
- anodic resistance locally decreased (i.e. anodic reaction accelerated) by the anaerobic biofilm.

1. Biocides

2. Materials: alloy adapted at its environments and the evolutions linked with bacteria

3. Conception: no stagnant waters / surface cleaning

4. Coatings: isolation of the alloy from the media

5. Cathodic protection: sacrificial anodes

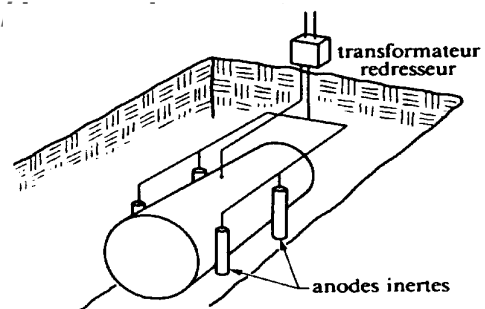
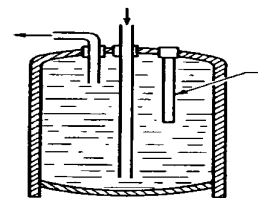



Commissariat à l'énergie atomique et aux énergies alternatives
Centre de Saclay | 91191 Gif-sur-Yvette Cedex
Damien Féron
T. +33 (0)1 69 08 20 65 | F. +33 (0)1 69 08 15 86
damien.feron@cea.fr

Direction de l'Energie Nucléaire
Département de Physico-Chimie
Service de la Corrosion et du
Comportement des Matériaux dans
leur Environnement

Etablissement public à caractère industriel et commercial | RCS Paris B 775 685 019