



HAL
open science

Advanced Multi-physics Simulation for Reactor Safety in the framework of the NURES SAFE Project

B. Chanaron, C. Ahnert, Nicolas Crouzet, Victor Sanchez, Nikola Kolev,
Olivier Marchand, A. Soeren, Papukchiev A

► To cite this version:

B. Chanaron, C. Ahnert, Nicolas Crouzet, Victor Sanchez, Nikola Kolev, et al.. Advanced Multi-physics Simulation for Reactor Safety in the framework of the NURES SAFE Project. *Annals of Nuclear Energy*, 2015, 84, pp.166-177. 10.1016/j.anucene.2014.12.013 . cea-02386823

HAL Id: cea-02386823

<https://cea.hal.science/cea-02386823>

Submitted on 29 Nov 2019

HAL is a multi-disciplinary open access archive for the deposit and dissemination of scientific research documents, whether they are published or not. The documents may come from teaching and research institutions in France or abroad, or from public or private research centers.

L'archive ouverte pluridisciplinaire **HAL**, est destinée au dépôt et à la diffusion de documents scientifiques de niveau recherche, publiés ou non, émanant des établissements d'enseignement et de recherche français ou étrangers, des laboratoires publics ou privés.

Advanced Multi-physics Simulation for Reactor Safety in the framework of the NURESAFE Project

Bruno Chanaron¹, Carol Ahnert², Nicolas Couzet¹, Victor Sanchez³, Nikola Kolev⁴, Olivier Marchand⁵, Soeren Kliem⁶, Angel Papukchiev⁷

¹CEA, Rue Leblanc, 75015 Paris, France, +33 1 69 08 57 04

²Universidad Politecnica de Madrid, Avenida Ramiro de Maetzu, 28040 Madrid, Spain

³Karlsruhe Institute of Technology, Hermann-vom-Helmholtz-Platz-1, 76344 Eggenstein-leopoldshafen, Germany

⁴INRNE, Tzarigradsko Shose 72, 1784 Sofia, Bulgaria

⁵Institut de Radioprotection et de Sûreté Nucléaire, Avenue de la Division Leclerc, 92260 Fontenay-aux-roses, France

⁶Helmholtz-Zentrum Dresden- Rossendorf, Bautzner Landstrasse, 01328 Dresden, Germany

⁷Gesellschaft fuer Anlagen- und Reaktorsicherheit (GRS) mbH, Schwertnergasse 1, 50667 Koeln, Germany

Abstract

Since some years, there is a worldwide trend to move towards “higher-fidelity” simulation techniques in reactor analysis. One of the main objectives of the research in this area is to enhance the prediction capability of the computations used for safety demonstration of the current LWR nuclear power plants through the dynamic 3D coupling of the codes simulating the different physics of the problem into a common multi-physics simulation scheme.

In this context, the NURESAFE European project aims at delivering to the European stakeholders an advanced and reliable software capacity usable for safety analysis needs of present and future LWR reactors and developing a high level of expertise in Europe in the proper use of the most recent simulation tools including uncertainty assessment to quantify the margins toward feared phenomena occurring during an accident. This software capacity is based on the NURESIM European simulation platform created during FP6 NURESIM project which includes advanced core physics, two-phase thermal-hydraulics, fuel modeling and multi-scale and multi-physics features together with sensitivity and uncertainty tools. These physics are fully integrated into the platform in order to provide a standardized state-of-the-art code system to support safety analysis of current and evolving LWRs.

Keywords: *NURESIM, SALOME, NURESAFE, Multi-physics, Multi-scale, reactor safety, simulation platform*

¹ Corresponding author: bruno.chanaron@cea.fr (Bruno Chanaron)

1-Introduction

In the framework of the EU Sustainable Nuclear Energy Technology Platform (SNETP), nuclear safety is a top priority (Jimenez, Chanaron, & Sanchez, 2013). In this field, an important challenge is the development of knowledge and tools such that to enable the reliable safety assessment of current reactors, as well as evolutionary and advanced reactors. Physical models and codes form the basis of this set.

The roadmap of the NURESIM simulation platform in general aims at improving the safety of light water reactors (LWR) through deterministic analysis of NPP events in the scope of the plant design basis (Design Basis Accidents - DBA). It is part of a global trend to move towards “higher-fidelity” simulation techniques in reactor analysis. Validation of the codes against experimental data is also an important objective for the roadmap.

The works under this roadmap are carried out through three successive projects as shown in figure 0.1. The first project, NURESIM, established the basic architecture of the platform and resulted in a first prototype of a truly integrated multi-physics simulation environment. The NURISP project was conceived as a consolidation of the platform together with an extension of the simulation capabilities towards higher-resolution both in space and time. The current NURESIM project will achieve the validation of the NURESIM platform, deliver industry-like applications and establish the platform as a reference European tool.

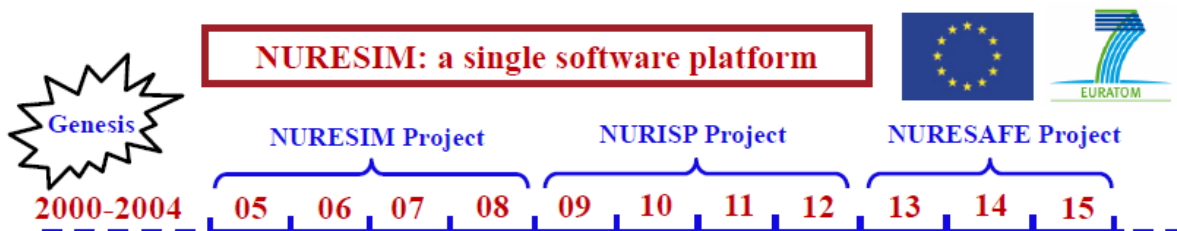

Figure 0.1 – the NURESIM roadmap

The NURESIM simulation platform is a set of codes covering core physics, thermal-hydraulics and fuel thermo-mechanics (figure 0.2). The codes are integrated in a common environment provided by the SALOME open-source software (<http://www.salome-platform.org/>). SALOME provides a generic user-friendly interface and is designed to facilitate the coupling of computing codes in a heterogeneous distributed environment as well as to facilitate interoperation between CAD modeling and codes.

The platform includes a tool for uncertainty quantification, sensitivity analysis and model calibration: the URANIE open-source software (<http://sourceforge.net/projects/uranie/>). URANIE is based on the ROOT software framework developed by CERN and it provides a simple mechanism for interfacing with codes or coupled codes in order to perform studies by analyzing data handled by the codes.

Further details on the NURESIM platform and the projects are presented in Section 2 and 3.

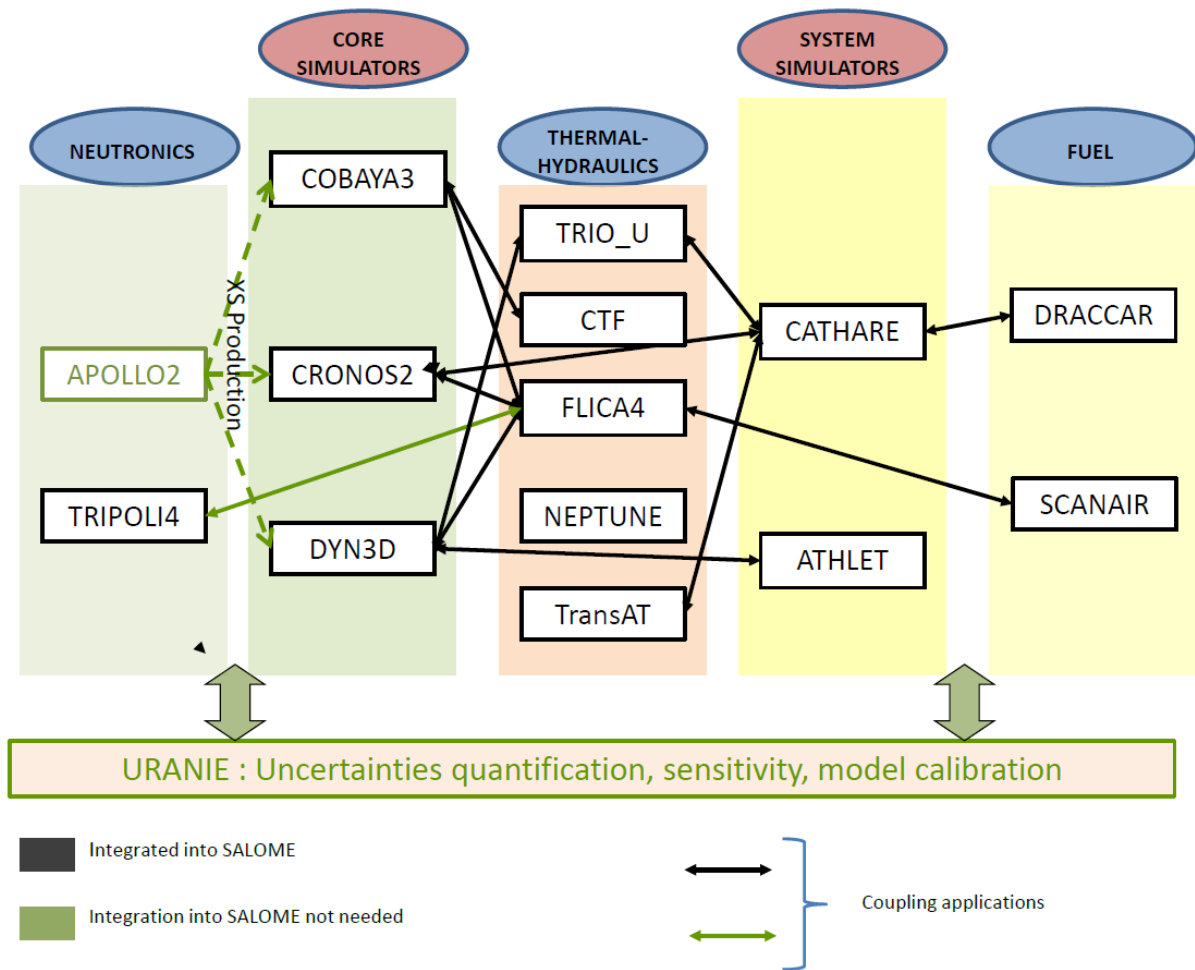

Figure 0.2 – the NURESIM platform

The NURISP and NURES SAFE projects cover a range of issues: multi-physics, thermal-hydraulics, core physics, fuel thermo-mechanics, uncertainties assessment and code calibration.

The objective of this article is to present the multiphysics activities of these projects. The details of these activities will be described in section 3. As regards the other parts, just say that:

- Concerning core physics, the main objective of the NURESIM roadmap is to provide pin by pin spatial resolution through the use of advanced calculation schemes for cross-section library generation and multi-scale core simulation tools.
- The thermal-hydraulics part of the NURESIM roadmap puts the focus on the multi-scale approach from DNS to system modeling, applied to LOCA simulation, pressurized thermal shock simulation, DNB prediction, dry-out prediction and condensation in the pressure suppression pool of boiling water reactors (BWR).

For details, the reader can refer to: (Bestion 2010), (Hegy i et al., 2012) and (Petrov, Todorova, 2011).

Developing multi-physics coupling methodologies is the major part of these projects. The objective is to enhance the prediction capability of the computations used for safety

demonstration of the current LWR nuclear power plants through the dynamic 3D coupling of the codes simulating the different physics of the problem into a common multi-physics simulation scheme. The NURISP and NURESAFE multi-physics activities are divided into several topics:

- improvement and implementation of higher-order coupling schemes,
- improvement and implementation of temporal coupling schemes,
- development of coupling interfaces between thermal-hydraulics system codes and CFD codes,
- development of coupling interfaces between thermal-hydraulics system codes and fuel thermo-mechanics codes, and
- application of the coupling schemes for the simulation of selected LWR transients: steam line break, boron dilution accident, BWR ATWS, LOCA.

The computational cost of these multiphysics simulations has not been identified as a significant concern within these projects. The participants to the simulation exercises use different computer resources available according to their countries and organizations and did not report the need for a more efficient computer service. Therefore, a sensitivity analysis of the use of computer resources, especially for optimization purposes, has not been performed yet but is considered in the future.

The NURESAFE project involves 18 countries and 23 partner organizations from the EU. (Figure 1). It includes 6 universities or highschoools, 10 research institutes and 6 industrial companies or technical support organizations (TSO).

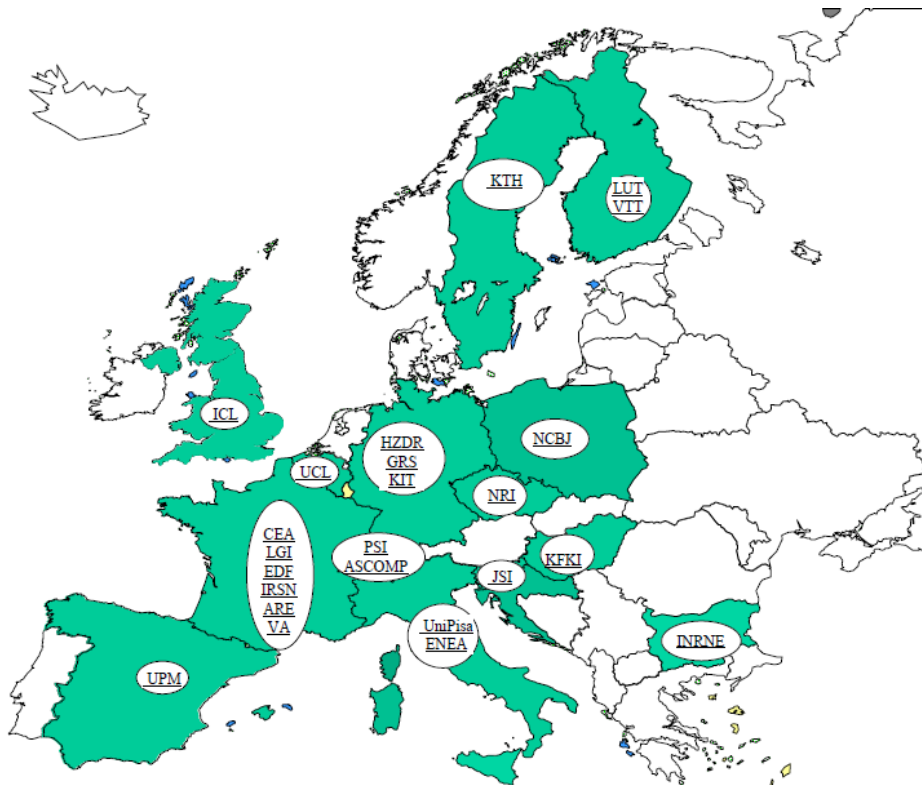

Figure 1 - the NURESAFE consortium

2-The SALOME platform

The NURESIM platform is based upon the software simulation platform SALOME. SALOME is an open-source project, (<http://salome-platform.org>), which implements the interoperability between a CAD modeler, meshing algorithms, visualization modules and computing codes and solvers. It mutualizes a pool of generic tools for pre-processing, post-processing and code coupling. Its supervision module (YACS, Figure 2) provides functionalities for code integration, dynamic loading and execution of components on remote distributed computing systems, and supervision of the calculation.

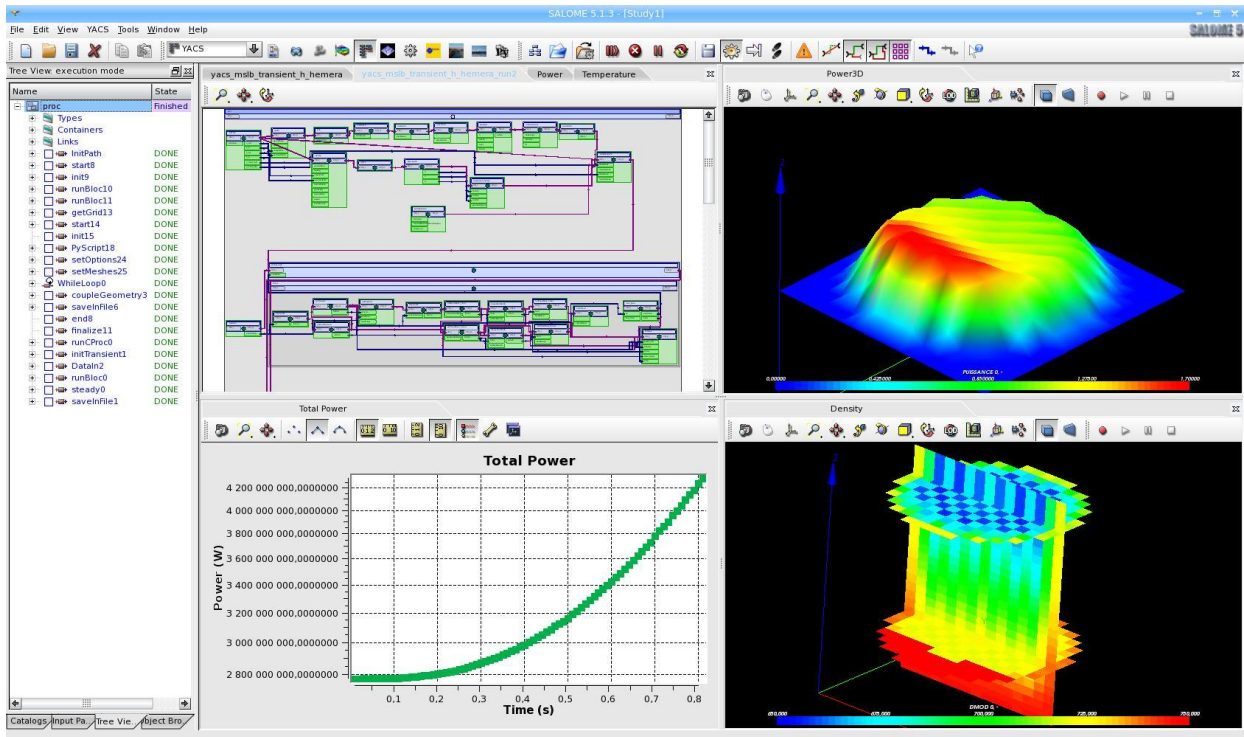

Figure 2 - The YACS user interface

The computing codes are wrapped into a C++ class which provides a coupling interface, and afterward they are integrated in SALOME platform as CORBA components (the CORBA layer being automatically generated by the platform integration module). This integration technique has the advantage of not requiring an access to the source of the coupled codes. Also it provides an explicit interface to the codes, which enables the coupling in an external coupling scheme, in our case a python script or a graph. This scheme is not implicit and embedded inside the source of the codes being coupled, thus it is clearer, and the debugging is much easier.

The data exchange is facilitated by the adoption of a common format for numerical meshes and fields (the MED library, an open standard provided by SALOME platform). This feature is of high importance as it is the basic support for all the coupling schemes that can be implemented between different codes once they are integrated as SALOME components.

The MED library also provides a complete set of interpolation algorithms, which has proven to be very useful when codes rely on different meshes.

3-Multi-physics Capacities developed in NURISP

3.1 Advanced boron dilution modeling

Hypothetical transients or accidents leading to the introduction of lower borated or even boron-free coolant into the reactor core can cause a reactivity transient. Under specific conditions, such boron dilution events can even lead to a super-prompt criticality of the reactor core. The subsequent behaviour of the reactor core in the calculations depends heavily on the modeling of the neutron kinetic / thermal hydraulic coupling in the core. It is characterized by a close interaction of both parts that means that a multi-physics simulation is needed. In addition to this interaction, the transport of the lower borated slug itself is of great importance for the whole course of the transient (Kliem, Rohde, 2004). For these reasons, the boron dilution transient is one of the most demanding scenarios for the multi-physics simulation.

Within the NURISP project, two neutron kinetics codes, COBAYA3 (Lozano, Garcia-Herranz, 2008) and DYN3D (Grundmann, Kliem, 2004 and Duerigen, Rohde, 2013), coupled with the thermal hydraulics code FLICA4 in the NURESIM platform (Kliem, Mittag, 2011) were employed to simulate boron dilution transients. For the purpose of coupling verification, a boron dilution benchmark was defined in the NURISP project (Kliem, Mittag, 2011). The couplings of COBAYA3 and DYN3D with FLICA4 were tested using these specifications. That test gave the possibility to assign differences in the obtained results to differences in the neutron kinetics methods implemented in DYN3D and COBAYA3 and assess their performance for this kind of transients.

Three transients were defined in the project, involving increasing volumes of diluted water entering the core inlet, to test the adequacy of the coupling between the codes. The calculations were performed for a standard PWR core containing 193 fuel assemblies. The time-dependent distribution of the boron concentration at the reactor core inlet was obtained from CFD calculations for three different initial slug volumes (for details see Kliem, Mittag, 2011). These distributions were provided as input to the computations with COBAYA3/FLICA4 and DYN3D/FLICA4. The simulations initiate from a subcritical state with all control rods inserted. The core is filled with water with a boron concentration of 2000 ppm. Advancing in time, the dilution front enters the core and starts to decrease the average concentration inside it. Accuracy in the dilution calculation depends strongly on the degree of numerical diffusion of the transport model, which affects the simulated dilution front evolution. The boron dilution in all three test cases is enough to have a considerable power peak reaching around 14000 MW (Slug 1), 45000 MW (Slug 2) and 60000 MW (Slug 3). The power peak occurs at the same time for all the codes but it can vary in width. The differences in the calculated power peaks with both the COBAYA3 FLICA and DYN3D FLICA code systems are very small, which builds confidence that the coupling was correctly implemented (Figure 3).

BORON DILUTION TRANSIENT - SLUG 2

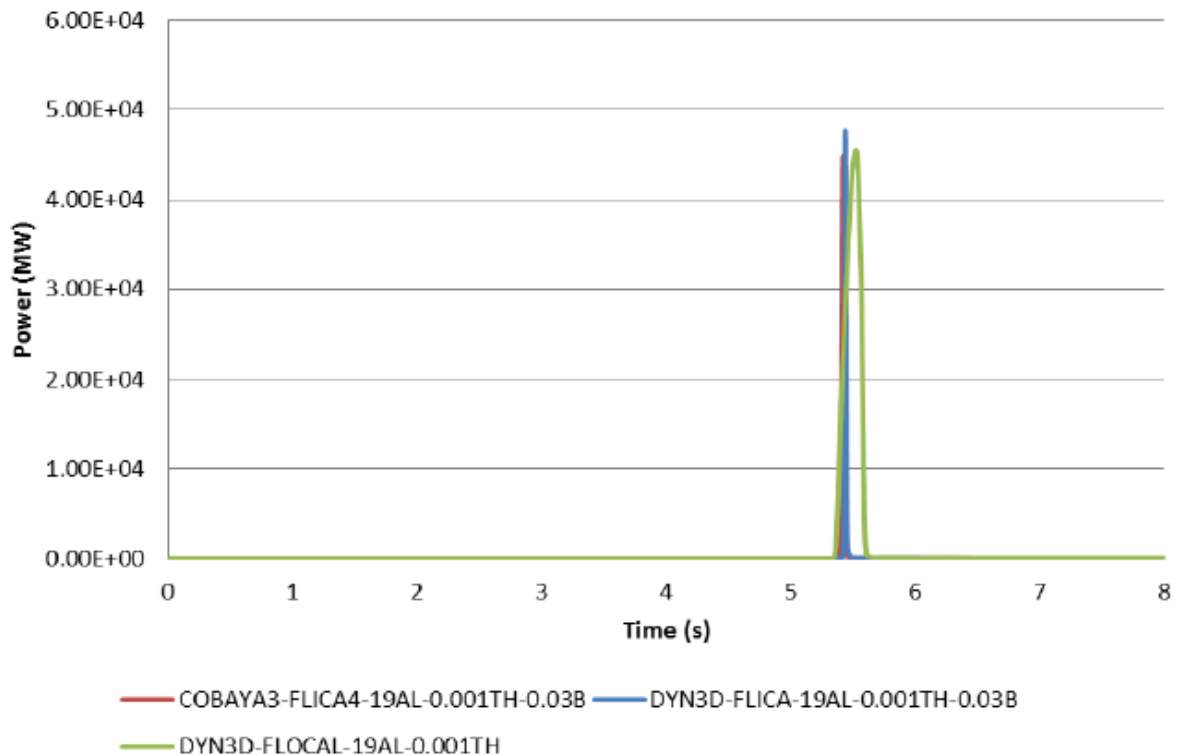

Figure 3– Neutronic power versus time during a boron dilution scenario

In detail the results are described in (Jimenez, Herrero, 2014). As a general conclusion, the boron dilution comparison between the codes was highly appropriate for testing the NK TH coupling within the SALOME platform, as the results are reasonable and similar between implementations. The neutronics codes performed adequately the transients, and several improvements have been done to simulate precisely the boron dilution event. The results verify the applicability of the implemented couplings to this type of problems accurately, where peak powers reached can be very high during short periods after which the reactor stabilizes at a few per cent of the nominal power.

3.2 Coupling system codes and fuel thermo-mechanics codes

As shown in the preceding paragraph, reactivity accidents are traditionally evaluated at the reactor scale by coupling a core thermal hydraulics code (e.g. FLICA-4) and a core neutronic codes (e.g. CRONOS2). For reasons of simplicity and efficiency, the thermal hydraulics code has generally a simplified model to describe fuel rod behavior.

Meanwhile, the impact of a power transient on the thermo-mechanical behavior of a fuel rod (at the local scale of the rod) is evaluated by codes of thermo-mechanical single-pencil (e.g. SCANAIR).

This type of software has a much finer description of phenomena involved in thermo-mechanical behavior of the rod (compared to thermal hydraulics core code) and usually the codes are composed of three main modules that are closely linked:

- a thermal module that calculates radial conduction in the fuel and cladding, as well as heat transfers with the coolant;
- a module that calculates the swelling of fission gas bubbles, grain boundary failure within the fuel and gas flows into free volumes;
- a mechanical module that calculates the different types of fuel deformation (thermal, elastic, plastic, strain related to cracks and swelling caused by fission gases) leading to cladding deformation or failure by taking into account the corroded state of the cladding.

The link between the two approaches is done by chaining the first to the second through the provision of neutron power and thermal-hydraulic conditions calculated by the global approach to the thermo-mechanical fuel rod code at the local scale.

Obviously raises the questions of the interest and the validity of this chaining. To answer this question, one of the tasks of the NURES SAFE project aims at coupling of three software CRONOS2 / FLICA / SCAN AIR (see Figure 4) via SALOME platform. In practice SCAN AIR will replace the fuel rod module of FLICA to have more advanced models taking into account the evolution of the properties of the fuel rod (fuel and cladding) with irradiation and the coupling between thermic, mechanics and gas behavior (e.g. fragmentation of the fuel, fuel swelling, fission gases release in the gap between fuel and cladding, cladding deformation, ...).

In this coupling, FLICA4 provides the fuel wall temperature T_p to SCAN AIR, the fluid temperature T_f , the fluid density ρ_f and the boron concentration c_b (moderator) to CRONOS2. CRONOS2 provides the fluid power to FLICA4 (gamma power fraction: $P_\gamma = \alpha P$), the thermal power to SCAN AIR (fuel thermal power fraction: $P_t = (1 - \alpha)P$). Finally, SCAN AIR provides the fuel temperature T_{fuel} to CRONOS2 and two specific thermal coupling coefficients (α^*, s^*).

Thus we will be able to assess whether the impact of a finer fuel rod modelling is important with respect to the overall modelling of such transient

It should also be noted that no feedback between the deformation of the rod and the core neutronic calculation will be taken into account at the coolant level, because FLICA imposes a fixed geometry of the fluid section channel.

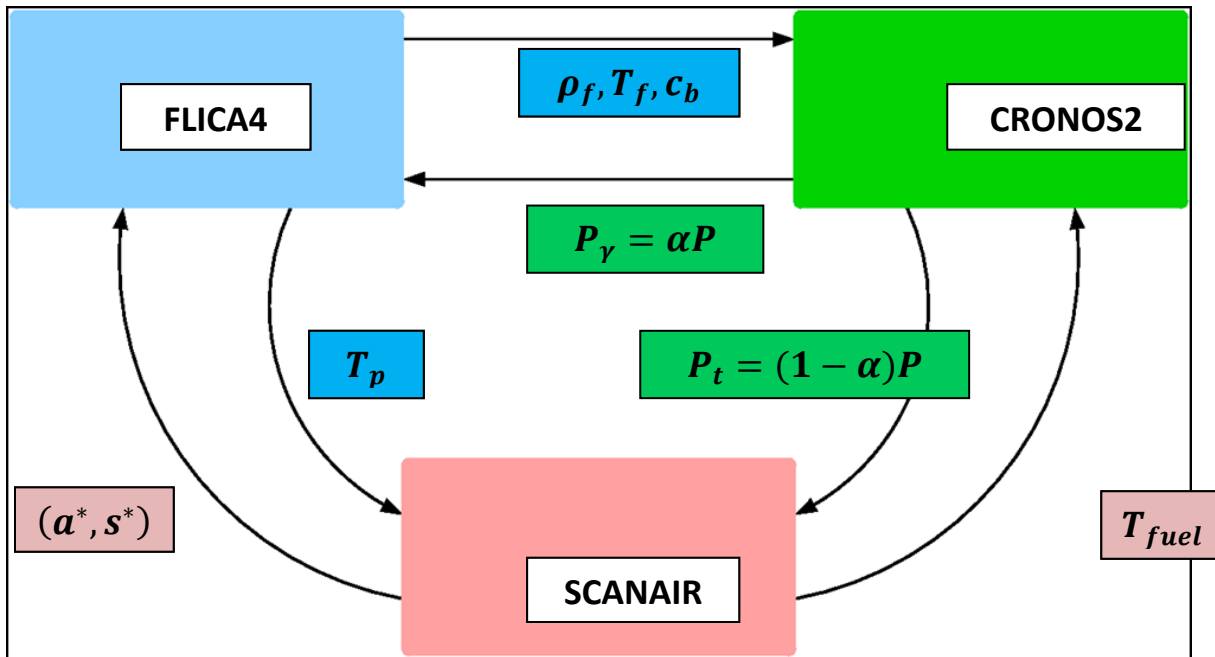

Figure 4- Principle of CRONOS2 / FLICA4 / SCANAIR coupling

3.3 Advanced coupling schemes for MSLB simulation

The COBAYA3/FLICA4 and CRONOS2/FLICA4 couplings at the nodal level via SALOME were tested in VVER-1000 MSLB simulation in the frame of the NURISP and NURES SAFE projects (Spasov et al, 2011), (Spasov et al, 2012) and (Spasov et al, 2013). For this purpose, a core boundary condition MSLB problem was defined in (Kolev & Spasov, 2009) based on the OECD V1000CT-2 benchmark (Kolev et al,2010). The reference core is Kozloduy-6, Cycle 8 at 270.4, near the end of life (EOL). A worst-case scenario is considered in which a return to power after scram is expected. The plant transient is initiated at hot full power by a main steam line break between the steam generator and the steam isolation valve, outside the containment. This event is characterised by large asymmetric cooling of the core and large primary coolant flow variations. One of the major concerns is the possible return to power and criticality after reactor scram, due to overcooling. The main objective of the study is to clarify the local 3D feedback effects depending on the vessel mixing.

The scenario is based on conservative assumptions which maximise the consequences for a return to criticality. Following the break and the scram signal, two peripheral control assemblies remain stuck out of the core, close to the location of maximum overcooling. The main coolant pump (MCP) of the faulted loop fails to trip on signal and all MCP remain in operation. There is no boron injection by the high-pressure pumps. In order to obtain a challenging test with a significant return to power, the scram rod worth is artificially reduced to about half of the nominal by adjusting the absorption cross-sections of the control rods.

The main features of the implemented coupling via SALOME are listed below:

- The single neutron kinetics and thermal hydraulic codes are integrated as components with a coupling interface

- YACS graphs or Python scripts are used to link dynamic libraries containing single codes and to express the calculation routes
- The data exchange is through the MED library and the MED coupling interface, providing a common format for numerical meshes and fields. The overlay of the neutronic and thermal-hydraulic meshes is done making use of the INTERP interpolation tool during the data exchange.

Using these features and having the different codes integrated as SALOME components with YACS interface, the coupled execution route of COBAYA3/FLICA4 (Jimenez, 2009) has been adapted to implement a new coupling of CRONOS2/FLICA4 (Spasov et al., 2009) without major developments.

The coupling schemes for VVER MSLB (Lozano et al., 2010) have been tested step-by-step. Standalone code calculations were verified against reference solutions and by code-to-code comparisons (Spasov et al., 2009), (Spasov et al., 2011) and (Spasov et al., 2012), in the frame of the NURISP project. The APOLLO2 generated multi-parameter VVER MSLB diffusion cross-sections library at the nodal level (Petrov, Todorova et al., 2011a); (Todorova et al., 2011) and the coupling were validated in steady-state core simulation vs. 2D whole-core transport reference solutions (Todorova et al., 2009) and versus Kozlodui-6 plant data at hot power. A pin by pin diffusion cross-section library (Petrov, Sanchez-Cervera et al, 2011b) with parameterization of the side-dependent interface discontinuity factors (Herrero et al., 2012) was tested in COBAYA3 lattice simulations. Transient results obtained with COBAYA3/FLICA4 coupling via SALOME (Spasov et al., 2011) were compared to those from independent couplings of COBAYA3/COBRA3 (Lozano et al., 2010), (Spasov et al., 2011) and DYN3D/FLOCAL (Hadek, 2011). For this purpose, the thermal-hydraulic codes used nearly the same modelling assumptions. As can be seen in Figure 5 and Figure 6, a significant return to power after scram occurs in this scenario and app. 50% of the nominal rated power is released in a few assemblies around the stuck rods.

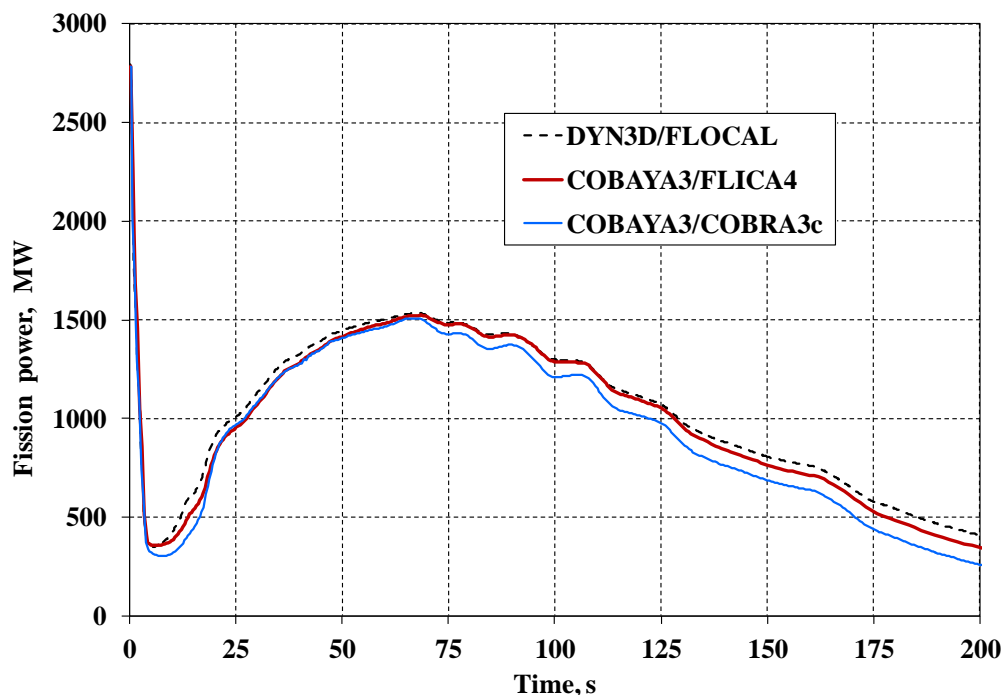

Figure 5 - Time history of core fission power

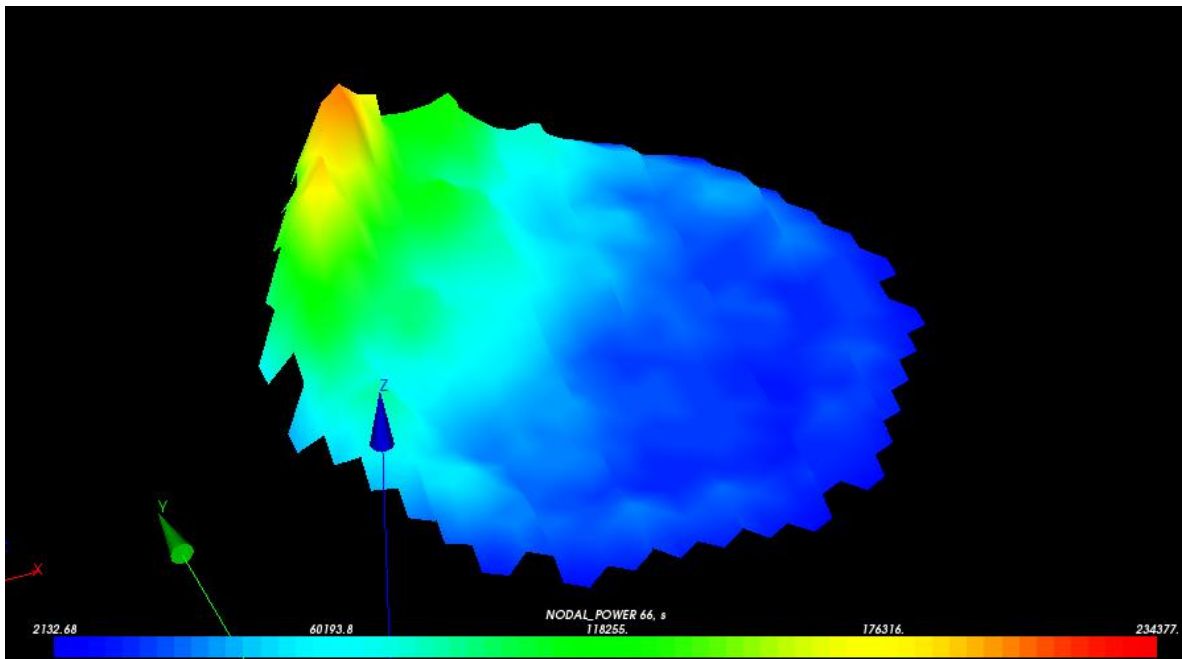

Figure 6- COBAYA/FLICA predicted 3D power distribution
at time of highest return to power (elevation 3.0 m)

The results in Figure 5 and the ones reported in (Spasov et al, 2011), (Spasov et al, 2012), (Spasov et al, 2013) show a good agreement of the SALOME-based and other couplings. When the nodal mesh is refined the solutions tend to converge to each other. The variety of couplings allows for the separation of the effects of neutron kinetics and thermal hydraulics modeling. The results show the applicability of the implemented couplings to this type of RIA analysis.

3.4 Coupling schemes for SUBCHANFLOW and DYN3D

One of the main advantages of the NURESIM Platform is the fact that any integrated code e.g. a thermal hydraulic one can be coupled with another solver, e.g. a neutronic solver, by adapting the coupling and execution routes without major developments. To show this flexibility, the coupling of SUBCHANFLOW, a subchannel thermal-hydraulic code, with DYN3D or COBAYA3 neutronic codes has been extended and tested within the SALOME platform (Calleja M. S., 2012), (Jimenez J. C., 2013), (Calleja M. J., 2014). The integration of SUBCHANFLOW inside the NURESIM platform has been done as an in-kind contribution of KIT. SUBCHANFLOW and COBAYA3 were also coupled via internal memory (Ochoa & Jimenez, 2012). In addition, DYN3D and FLICA4 were coupled inside the NURESIM platform and successfully used to perform steady state and transient simulations of PWR cores (Gomez, Sanchez, Kliem, 2010). Based on this experience at KIT and taking

advantages of the unique features of the NURESIM platform to easily couple codes that are already implemented in the platform, a steady state and transients coupling schemes for DYN3D and SUBCHANFLOW were developed and implemented.

In this coupling approach, the spatial mapping is based on the mesh superposition principle, making use of the INTERP interpolation tool during the data exchange, see Figure 7.

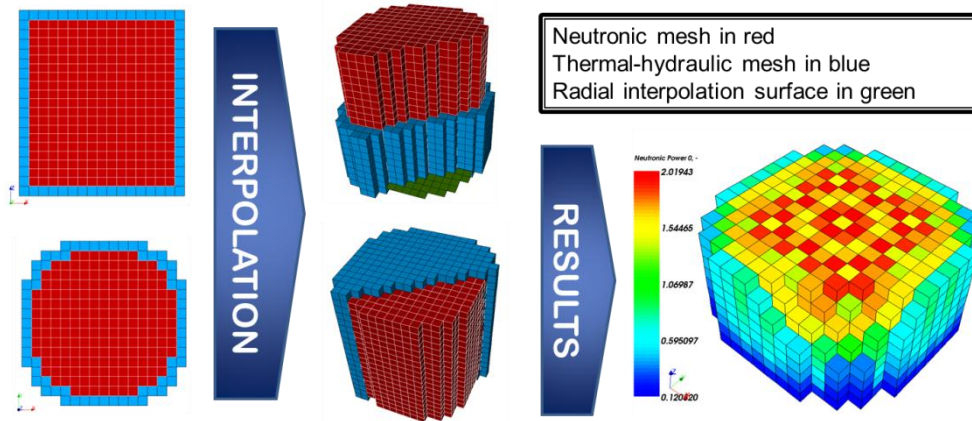

Figure 7- Neutronic and Thermal-hydraulic mesh interpolation using the INTERP tool

For a steady state simulation, the dataflow in the developed iterative explicit coupling scheme is depicted in Figure 8. Each solver is called independently using the data provided by the other code in a sequential manner using its own numerical scheme. In this coupling approach, DYN3D starts with assumed thermal-hydraulics boundary conditions. At that step, the cross sections are updated based on a flat axial coolant and fuel temperature distribution. The so predicted 3D power distribution is transferred to SUBCHANFLOW through the corresponding MED Coupling field. Then SUBCHANFLOW solves the thermal-hydraulics problem with the actual power and obtain the feedback parameters such as Doppler temperature (T_{Dopp}), moderator temperature (T_{mod}), moderator density (ρ_{mod}), boron concentration (B_{ppm}) and void fraction (α). These parameters are passed to the neutronic solver for the power prediction at the next iteration step. These steps are repeated until a converged coupled solution is reached. It is the case, when the rate of change of local thermal hydraulic parameters and also of global parameters such as effective multiplication factor and total power between two subsequent iterations are below certain values (convergence criteria). These convergence criteria are set by the user in the input decks of each code based on both the neutronic and thermal-hydraulics parameters. Typical convergence criteria used are 1.0^{-6} (ϵ_N) for the k_{eff} and total power and 1.0^{-4} (ϵ_T) for T_{Dopp} , T_{mod} and ρ_{mod} .

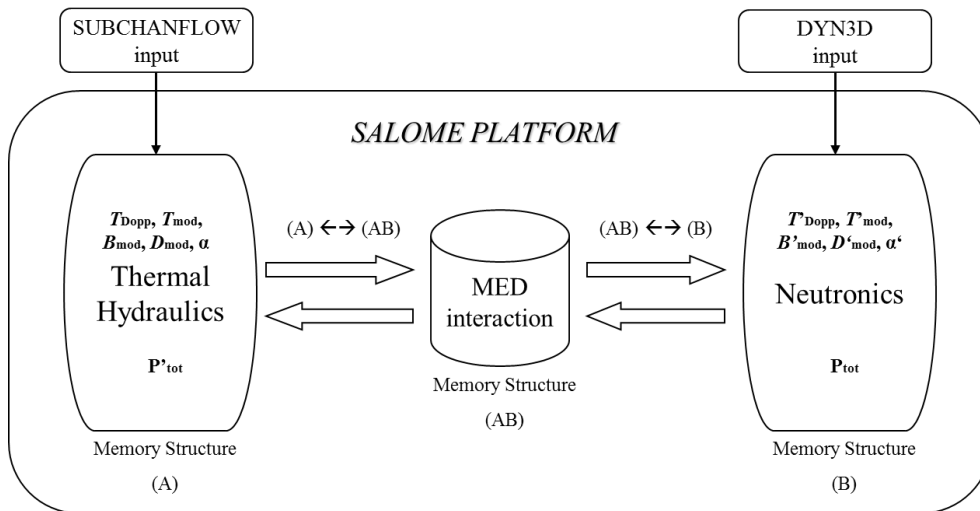

Figure 8- Dataflow in the coupling scheme between DYN3D-SUBCHANFLOW

The NURESIM platform offers the possibility to implement a relaxation method to speed-up the convergence of the coupled solution. In the coupling schemes presented here, no relaxation method was implemented since the coupled solution converged after 8 to 10 iterations. In case of off-initial conditions, the coupled codes may need around 20 to 30 iteration steps to converge.

The coupling code DYN3D-SUBCHANFLOW was applied for the analysis of a rod ejection problem (REA) in a 3x3 FA minicore problem consisting of UOX and MOX fuel assemblies and surrounded by reflector (water) (see Figure 9). Control rods were located only in the central UOX-FA. This problem was derived from the NURISP benchmark problem (Kliem, 2011) which is based on the OECD PWR OX/UO2 core transient benchmark definition.

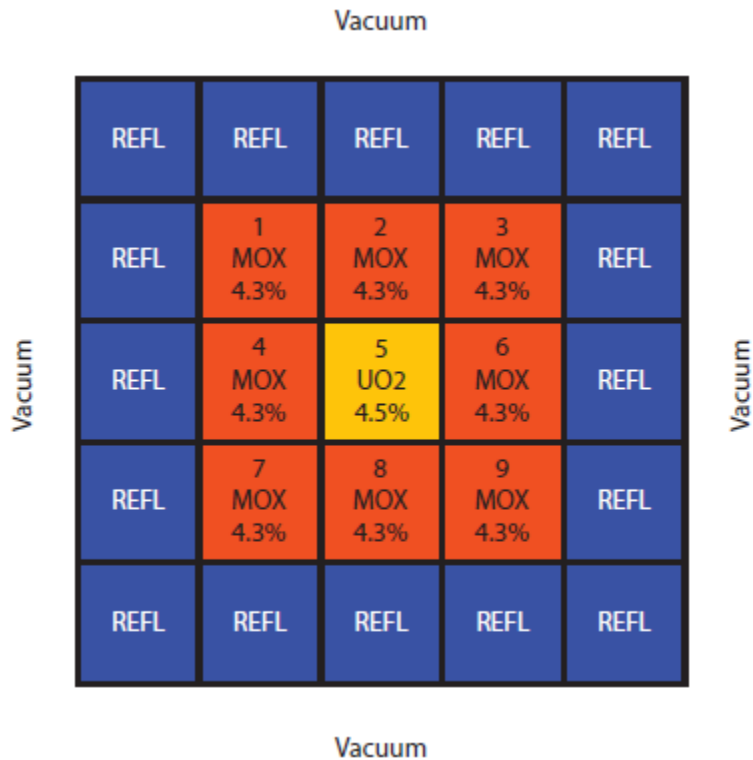

Figure 9 - 3x3 Minicore with the central UOX-FA containing the control rods

For the REA analysis, hot zero power conditions of the minicore are considered; meaning that the core power is 1 W, the mass flow rate around 740 kg/s, the system pressure amounts 15.4 MPa and the core inlet temperature is 560 K. Once the core is HZP critical conditions, the control rods are ejected within 0.1 s.

This HZP PWR minicore REA transient was calculated with both the COBAYA3-FLICA and the DYN3D-SUBCHANFLOW coupling schemes implemented within the NURESIM Platform. In Figure 10, the total power as predicted by the two code systems is shown. It can be observed that the maximal power is achieved before the control rods are fully extracted from the core. The overall trends of the predicted power are very similar for both codes. The main differences observed during the first 0.08 s can be attributed to the differences in the thermo-physical properties of the MOX and UOX as well as to the gap heat transfer models of FLICA and SUBCHANFLOW.

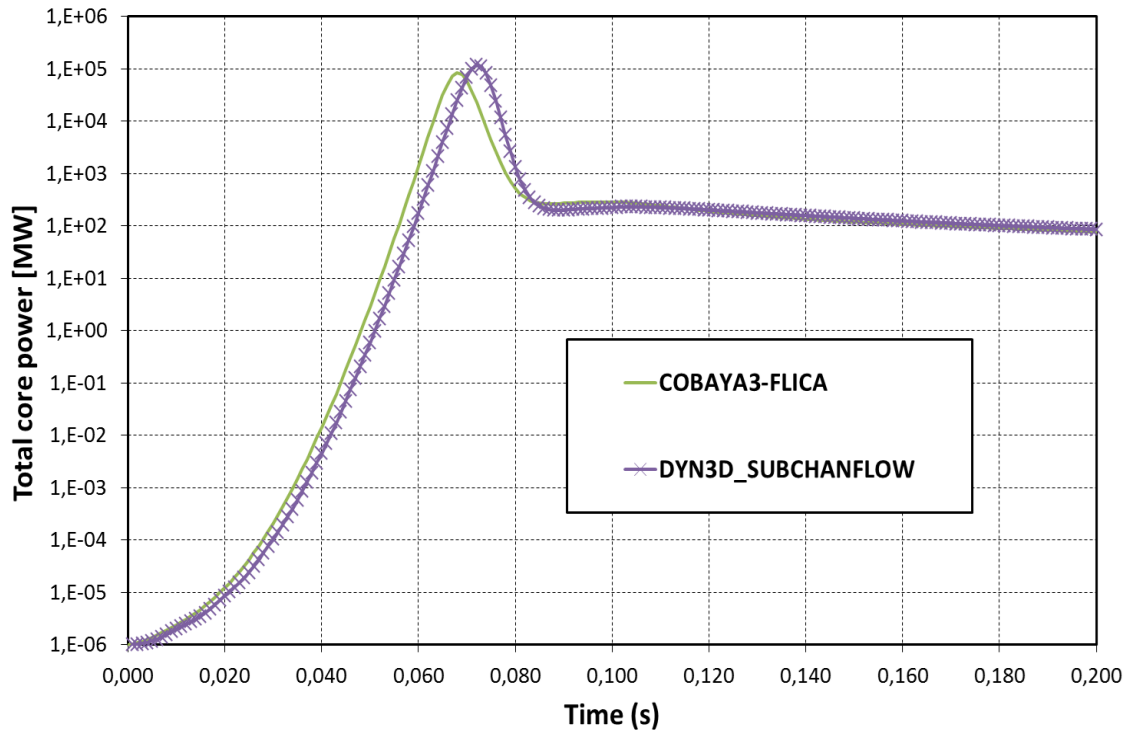

Figure 10- Comparison of the predicted total power of the minicore by the two coupled codes

The development presented here illustrates the peculiarities of the NURESIM platform regarding the multi-physical coupling of different solvers: if an N/TH-coupling scheme is implemented and established within the NURESIM Platform – as it was the case for the COBAYA3-SUBCHANFLOW coupling - it is straightforward to replace a solver (in this case the solver COBAYA3) by another one (the DNY3D solver) and to use the coupling scheme to perform simulations.

3.5 Simulation of ROSA LSTF using ATHLET-CFX coupling

Within the FP7 EU project NURISP, the GRS system code ATHLET was coupled with the commercial CFD software package ANSYS CFX. The main objective was to improve the simulation capabilities of the 1D program for flows with pronounced 3D effects like mixing and stratification, being important for particular transients and accidents like pressurized thermal shock, boron dilution or main steam line break. Main efforts were related to the implementation of explicit and semi-implicit schemes, the simulation of different test configurations as well as to the validation on the OECD/NEA Rig of Safety Assessment (ROSA) V Test 1.1, carried out at the Japanese Large Scale Test Facility (LSTF). This experiment is challenging for any thermal-hydraulic program and even more for coupled codes, because strong buoyancy and mixing effects in natural circulation conditions have to be addressed in a proper manner (Papukchiev, Lerchl 2011)

3.5.1 Pressurized Thermal Shock and ROSA V Test 1.1

Pressurized thermal shock may occur when cold water is injected in the primary circuit of a PWR, filled with hot coolant. The cold water may rapidly cool down the reactor pressure vessel (RPV) wall when entering the downcomer. This greatly increases the potential for

RPV failure by cracking. The cool down process can be even intensified by a thermal stratification in the cold leg. Thermal stresses are more dangerous for the RPV downcomer compared to the cold leg structures because of its thick walls and the presence of welds.

The Japanese LSTF represents a four-loop, 3423 MW thermal power Westinghouse PWR by a full-height and 1/48 volumetrically-scaled two-loop system, Figure 11. The goal of the ROSA V Test 1.1 experiment was to investigate flow mixing and temperature stratification under natural circulation conditions, and to provide data for the validation of computer codes (JAERI, Tokai Research Establishment, 2003). Temperatures were measured with thermocouple rakes in the cold legs below the injection nozzle (TE1), and at two cross-sectional planes between the injection nozzle and the downcomer (TE2, TE3), see Figure 12. Each rake in the cold leg consists of 21 thermocouples positioned in three columns and seven rows.

The experiment started with forced circulation and when the pumps were switched off, natural circulation at 15.5 MPa and 2% core power established in the primary circuit. The simulation results presented in this paper are focused only on the first phase of Test 1.1, where ECC water was injected for about 110 s in the cold leg A at these conditions. Table 1 shows the initial values of the main thermal-hydraulic parameters before the ECC injection.

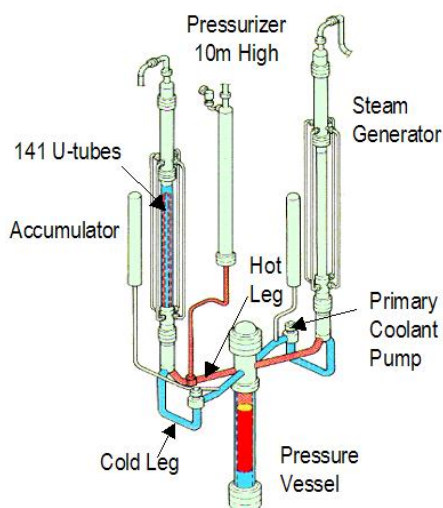

Figure 11- Large Scale test Facility

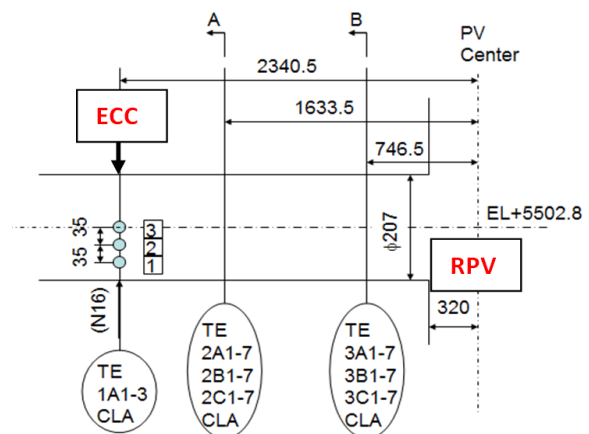

Figure 12 - Measurement rakes in cold leg A

TABLE 1 – Initial and boundary conditions

Parameter	Initial value
Fluid temperature at pump exit	553.7 [K]
Mass flow rate at pump exit	5.9 [kg/s]
Fluid density at pump exit	764 [kg/m ³]
Fluid velocity at pump exit	0.24 [m/s]
Pressure at cold leg outlet	15.5 [MPa]

3.5.2 ATHLET-ANSYS CFX model

Due to the 3D nature of the stratification and mixing phenomena in PTS, such reactor safety problems need to be simulated with advanced 3D CFD tools. Since the ECC injection and flow stratification occur in the cold leg A, it was decided to model its 4 m long section between the main coolant pump and the RPV downcomer with ANSYS CFX. Therefore, a high quality hexahedral mesh (1.13 M cells) of this part of cold leg A was generated. The Baseline Reynolds Stress Turbulence model (BSL RSM) (ANSYS Reference Guide, 2006) was selected for the coupled simulations. Moreover, 'automatic' wall functions were utilized, in which the near-wall fluxes are derived from either linear or logarithmic wall laws, depending on the position of the wall-adjacent grid point. The rest of the facility was extensively modeled with ATHLET. Figure 13 shows the coupled ATHLET-ANSYS CFX model of LSTF.

3.5.3 Analysis and comparison of the simulation results with experimental data

In the first step of the comparative analysis, the results from the performed coupled 1D-3D simulations were visualized with the help of ANSYS CFX Post software. The vertically downwards injected cold ECC water hits the bottom of the cold leg and then swashes to the left and right pipe walls. Due to its higher density, the cold water pushes the lighter hot water to the top and gradually stratifies at the bottom of the cold leg, see Figure 14. The maximum temperature difference between top and bottom of the pipe in this cross-section is 12 K.

Figure 15 shows the comparison with data for the thermocouple TE1205 (rake TE3), which is situated centrally at the bottom of the cold leg A. Most of the results for the thermocouple rake TE3, which is close to the RPV inlet, are in good agreement with the experimental data and deviate within the measurement uncertainty. However, the comparison for the TE2 rake, which is close to the ECC injection nozzle showed larger deviations from the experimental data. It was found, that this is due to insufficient RANS turbulence modelling of the impinging ECC injection jet. Nevertheless, for both measurement rakes very good agreement between ANSYS CFX stand-alone and ATHLET - ANSYS CFX calculations can be observed. This result proves the consistency of the coupling methodology.

Figure 16 compares ATHLET stand-alone and coupled ATHLET - ANSYS CFX results for the average pipe cross-section temperatures in the ATHLET control volume downstream of the ANSYS CFX domain near the RPV downcomer inlet. The good agreement among experiment, ATHLET and ATHLET - ANSYS CFX demonstrates that the coupled code system successfully accomplishes the transition from spatially distributed to lumped parameter approximation schemes. The comparison with the measured temperature averaged over 21 thermocouples distributed across the pipe cross section shows that the end of the injection phase is well predicted by the coupled codes due to the significantly reduced numerical diffusion.

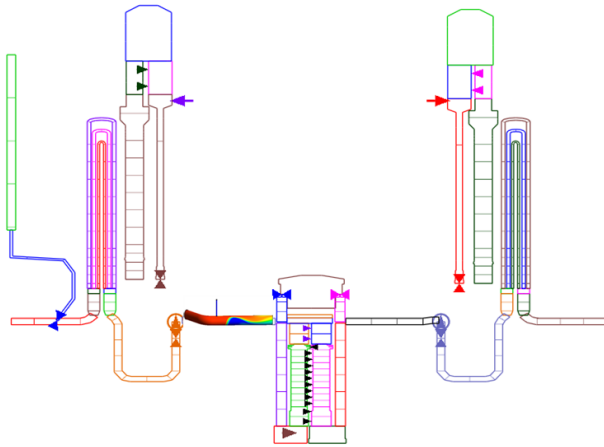

Figure 13- Coupled model of the LSTF

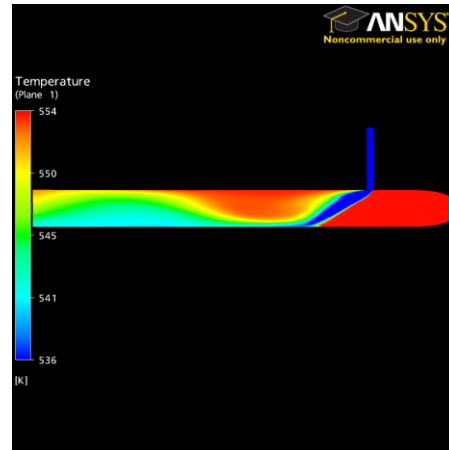

Figure 14 - Temperature distribution in cold leg A

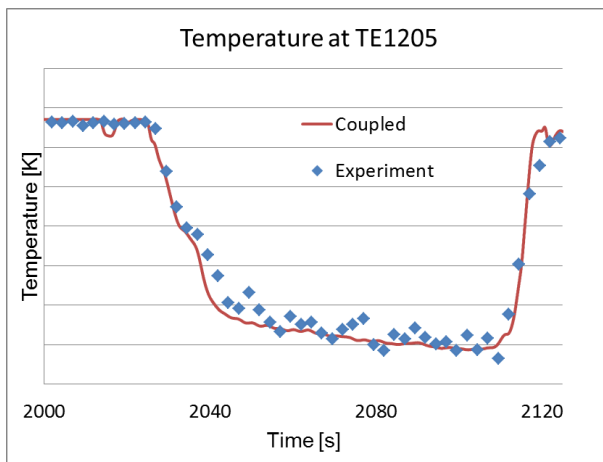

Figure 15- Local temperature at TE1205

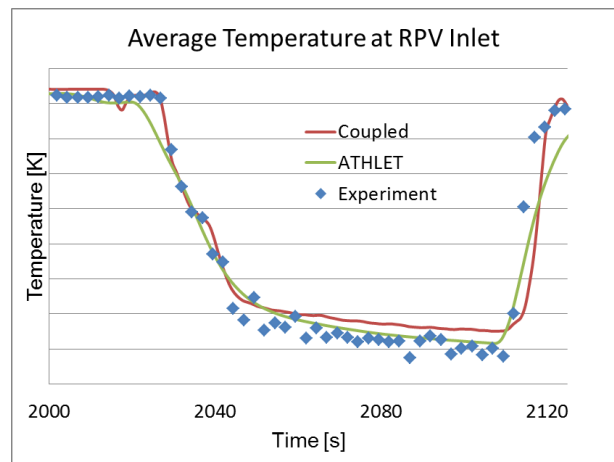

Figure 16 - Averaged temperature at RPV inlet

4. Progresses foreseen within NURESAFE

NURESIM and NURISP paved the way for arriving at a European platform that will allow progress towards higher-fidelity reactor simulation in an incremental manner. Well established and validated codes covering different domains of the reactor analysis are coupled after the NURISP project: several transient core dynamics codes are coupled with a core-thermal-hydraulics code that offers sub-channel capability, using the SALOME coupling software. It allows for quite general mapping between the calculated fields of exchanged variables and represents a necessary key feature for multi-physics. Mixing phenomena occurring in the large volumes of the RPV are analyzed with the help of CFD-codes and these codes are interfaced through SALOME with the NURESIM system-behavior codes. Thermo-mechanics codes are also being fully integrated into the NURESIM platform, as

current needs for safety assessment need a very precise account of the status of the fuel pins, especially in relation to the possibly activity release from it during accident sequences.

To make higher-fidelity reactor simulations a reality, coupling higher-order tools such as CFD and pin-by-pin neutronics solvers is envisaged within the NURESAFE project. During Main Steam-Line Break scenarios, colder coolant enters the core region and causes a local power increase. An accurate simulation of this situation requires the coupling of CFD to neutronics solvers in order to well capture the effects of the local feedback. It should be remembered that a similar situation also occurs for boron dilution accident (e.g. following a SBLOCA). The coupling to a neutronics solver attempted within the NURESAFE project will be a proof of concept for a restricted (mini-) core region, realizing that full core transient pin-by-pin neutron transport calculations are still at the very edge of today's computational capabilities, but it is very likely that such detailed calculations will become feasible soon.

Another innovative element within NURESAFE represents the comprehensive analysis including neutronics, thermal-hydraulics and thermo-mechanics. Especially, NURESAFE will integrate thermo-mechanical analysis for the considered transients. The proper level of spatial detail but will be chosen for each situation target separately.

In addition, an uncertainty evaluation will be conducted for the simulation of a BWR ATWS scenario. This evaluation includes thermohydraulics parameters, cross-section uncertainties being excluded, This simulation will be based on the Oskarshamm-2 NPP benchmark. The transient simulated is the Oskarshamm-2 1999 stability event. This event was initiated by a loss of feed-water preheaters and a control system failure that drove to diverging power oscillations. This problem is challenging to neutron kinetics and core thermal-hydraulics coupling. The work program calls for an objective estimation of the PDF's of the uncertain thermal-hydraulic parameters using a procedure developed during NURISP and part of the URANIE module. The error propagation using Monte Carlo sampling (currently a standard approach) will then establish the uncertainty for the key parameters of the reactor. An important aspect is the consideration of the uncertainty induced by the coupling schemes, not usually considered in such analysis.

The NURESAFE program of work is organized in the simulation of some accidental scenarios named "situation targets" relevant for LWR reactors safety. In order to fulfill the individual codes and models validation, "situation targets" modeling include reference calculations, validation against experiments and plant data. The challenging selected "situation targets" have been selected with respect to their potential for two-way coupling:

- PWR main steam line break (MSLB)
 - ✓ PWR application
 - ✓ VVER application
- Boiling water reactor anticipated transient without scram (BWR ATWS)
- Loss of coolant accident (LOCA) in PWR

PWR and VVER MSLB

The goal is to perform best-estimate analysis for a PWR main steam-line break scenario using coupled NURESIM codes, supplemented by uncertainty evaluation for thermal-hydraulics, and thermo-mechanical parameters. The key features of the application to be developed are: an improved representation of the core regions with strong concentration

gradients, an accurate boron concentration and temperature distribution from CFD modeling and a systematic uncertainty evaluation.

To meet these requirements, the emphasis is put on the development and validation of integrated coupling interfaces between:

- System thermal-hydraulics,
- 3D neutronics, at the pin-by-pin level,
- detailed simulation of mixing phenomena in the reactor pressure vessel, including core region,
- Thermo-mechanic evaluation of fuel safety parameters.

By modeling the MSLB transient in this way, this work will generate reference results at the cutting-edge of current analysis technology and will provide more accurate assessment of margins between key parameters and safety criteria.

BWR ATWS

Similarly to PWR, the objective is a best-estimate analysis for a BWR ATWS scenario, based on the Oskarshamm-2 1999 event, using coupled NURESIM codes, supplemented by uncertainty evaluation for TH and thermo-mechanical parameters. In order to generate reference results at the forefront of current analysis technology, the analysis framework featuring coupled simulations will combine:

- System thermal-hydraulics,
- 3D neutronics,
- Thermo-mechanic evaluation of fuel safety parameters,
- Uncertainty evaluation.

The expected outcome of this task is a set of best-estimate coupled solutions with an evaluation of the uncertainties focused on selected parameters as the maximum nodal/pin power peaking factors, the maximum cladding temperatures and energy deposited in the pressure suppression pool.

LOCA

LOCA transients are currently analyzed by System TH codes such as CATHARE and ATHLET. The addition of two-phase CFD tools and of advanced fuel models allows revisiting these transients for more accurate and reliable predictions. This requires coupling of CFD with system codes, coupling of fuel thermo-mechanics with thermal-hydraulic codes and new methods for evaluation of accuracy, sensitivity and uncertainty of coupled simulation tools. Following the coupling between the system-code CATHARE and the fuel thermo-mechanics code DRACCAR, made in NURISP, it is now to investigate the fuel pin ballooning phenomena during LOCA accidents. This task includes a validation against experiment which simulates the possibility to cool ballooned fuel bundles.

VALIDATION

The validation of the “situation target” models will be done by using experiments, reference plant data and quantitative deterministic and statistical sensitivity and uncertainty analyses with the methods developed within NURISP in URANIE software. Therefore, each situation

target includes a specific S&U and validation task. In order to avoid duplication, the NEA and IAEA databanks will be used to contribute to the validation.

Concerning codes and models, the NURES SAFE project will of course benefit from the validation tasks of core physics and thermal-hydraulics codes achieved at the end of the NURISP project. Validation of coupled schemes is always difficult because of a lack of sufficiently detailed and representative experiments performed on real reactors. Therefore, validation work will focus on some specific features of the simulated situation targets. With regard to the MSLB, one challenging problem is the validation of the core inlet flow mixing matrix. As relevant to this problem, we will use the experimental ROCOM dataset representative of a vessel of a German PWR in order to compare simulations against measurements. Another validation task will be based on the Kozlodui-6 transient representing a steam generator isolation experiment from a steady power state.

In addition, these models need to be tested using uncertainty quantification methods. For this purpose, UQ evaluation will be performed on a BWR transient including propagation of uncertainties on all the physics.

Acknowledgments

This work is partially funded by the European Commission under the 7th EURATOM Framework Program within the NURES SAFE Project contract No. 323263.

References

ANSYS CFX Reference Guide, ANSYS CFX Release 11.0, 2006.

Bestion, D., 2010, Two-phase CFD advances in the NURESIM and NURISP projects, Proceedings of the international conference on nuclear engineering ICONE 18, May 2010, Xi'an (China)

Calleja, M. J., Jimenez, J., Sanchez, V., Imke, U., Stieglitz, R., Macian, R., 2014, Investigations of Boron Transport in a PWR Core with Coupled Neutronic/Thermal-hydraulic Codes Inside the NURESIM Platform. *Annals of Nuclear Energy*, Volume 66, pages 74–84

Calleja, M., Stieglitz, R., Sanchez, V., Jimenez, J., Imke, U., 2012, A Coupled Neutronic/Thermal-hydraulic Scheme between COBAYA3 and SUBCHANFLOW within the NURESIM Simulation Platform. *PHYSOR*. Knoxville, Tennessee. USA

Däubler, M., Trost, N., & Jimenez, J., 2013, Recent developments in DYN3D: new models, code optimization and parallelization. M&C. Idaho, USA

Duerigen, S.; Rohde, U.; Bilodid, Y.; Mittag, S., 2013, The reactor dynamics code DYN3D and its trigonal-geometry nodal diffusion model, *Kerntechnik*, 78, pp. 310-318

Gomez, A., Sanchez, V., Kliem, S., 2010, DYN3D/FLICA coupling Integration of DYN3D inside the NURESIM Platform. 17th Pacific Basin Nuclear Conference. Cancún, México

Grundmann, U.; Kliem, S., 2004, Analyses of the OECD main steam line break benchmark with the DYN3D and ATHLET codes, *Nuclear Technology*, vol. 142, pp. 146-153

Hadek, J., 2011, VVER MSLB results with DYN3D/FLOCAL, NURISP D3.1.3.3b-Rev1 report

Hegyí, G., Kereszturi, A., Tota, A., 2012, Qualification of the APOLLO2 Lattice Physics Code of the NURISP platform for VVER hexagonal lattices, *Kerntechnik Journal* issue 2012/04, pp 218-225

Herrero,J.J., García-Herranz, N.,Cuervo, D.,Ahnert,C., 2012, Neighborhood-corrected interface discontinuity factors for multi-group pin-by-pin diffusion calculations for LWR, *Annals of Nuclear Energy*, 46, 106-115

JAERI, 2003, "ROSA V Large Scale Test Facility (LSTF) System Description for the Third and Fourth Simulated Fuel Assemblies", Tokai Research Establishment, Japan Atomic Energy Research Institute

Jimenez, J., 2009, COBAYA3/FLICA4 coupling at the nodal level via SALOME, UPM Internal Report

Jimenez, J., Calleja, M., Sanchez, V., 2013, Application of the coupled code COBAYA3/SUBCHANFLOW to the simulation of the Exercise 2 of the OECD/NEA Kalinin-3 Benchmark. 39th Annual meeting of the Spanish Nuclear Society. Reus, Spain

Jimenez, J. Chanaron, B., Sanchez, V., Cheng, X., 2013, Advanced Numerical Simulation for Reactor Safety, 8th European Conference on EURATOM research and training in reactor systems, FISA 2013, program and abstracts, p. 21

Jimenez, G., Herrero, J.J.; Gommlich, A., Kliem, S., Cuervo, D., Jimenez, J. , 2014, Boron dilution transient simulation analyses in a PWR with neutronics/thermal hydraulics coupled codes in the NURISP project, *Annals of Nuclear Energy*, submitted

Kliem, S.; Gommlich, A.; Grahn, A.; Rohde, U.; Schuetze, J.; Frank, T.; Gomez, A.; Sanchez, V., 2011, Development of Multi-Physics Code Systems based on the Reactor Dynamics Code DYN3D, *Kerntechnik*, 76, pp. 160-165

Kliem, S., Mittag, S., Gommlich, A., Apanasevich, P., 2011, Definition of a PWR boron dilution benchmark, NURISP report D3.1.2.2, 23p.

Kliem, S., Rohde, U., Weiss, F.-P. , 2004, Core response of a PWR to a slug of underborated water, *Nucl. Eng. Design*, vol. 230, pp. 121-132

Kolev, N. et al., 2010, VVER-1000 Coolant Transient Benchmark, Phase II (V1000CT-2) : Vol.2, MSLB Problem – Final Specifications, NEA/NXC/DOC(2006)6, © OECD 2010

Kolev, N., Spasov, 2009, I., VVER MSLB Core Benchmark Specification Report, NURISP D3.1.3.1 Report

Lozano, J.-A., Garcia-Herranz, N., Ahnert, C. and Aragonés, J.M., 2008, The analytic nodal diffusion solver ANDES in multigroups for 3D rectangular geometry: Development and performance analysis., *Annals of Nuclear Energy* 35(12)

Lozano, J.A., Jiménez,J., García-Herranz,N., Aragonés,J.M., 2010, Extension of the analytic nodal diffusion solver ANDES to triangular-Z geometry and coupling with COBRA-IIIc for hexagonal core analysis. *Annals of Nuclear Energy*, 37, 380-388

Ochoa, R., Jimenez, J. Garcia-Herranz, N., 2012, Development of the neutronic/thermal-hydraulic coupling between COBAYA3 and SUBCHANFLOW. Application to Sodium Fast Reactors", 38th Annual meeting of the Spanish Nuclear Society 2012, Caceres, Spain

Papukchiev, A., Lerchl G., Weis, J., Scheuerer, M., Austregesilo, H., 2011, Development of a Coupled 1D-3D Thermal-Hydraulic Code for Nuclear Power Plant Simulation and Its Application to a Pressurized Thermal Shock Scenario in PWR, Proc. of the NURETH-14 Conference, Toronto, Canada, September 25-30, 2011

Petrov, N., Todorova, G., Kolev, N., Damian, F., 2011, Two-level MOC calculation scheme in APOLLO2 for cross-section libraries generation for LWR hexagonal assemblies, Proc. M&C 2011, Rio de Janeiro, Brazil, May 8-12, 2011; on CD ANS (2011)

Petrov, N., Sánchez-Cervera, S. and Herrero, J.J., 2011 “Steps ahead of the few-group cross-section library generation at the pin level”, Proc. AER 2011 Conf. on VVER Reactor Physics and Safety, Dresden, September 20-23

Spasov, I., Jimenez, J., Lozano, J., Herrero, J.J., 2009, “COBAYA3/COBRA3 vs. CRONOS2/FLICA4 solutions of the V1000CT-EXT2 benchmark for VVER-1000”, UPM Internal Report, July 2009; Proc. 19th AER Conf. on VVER Reactor Physics and Safety, Varna, Bulgaria, September 2009

Spasov, I., Kolev, N., 2013, Full core FLICA4 input model for VVER MSLB analysis, NURESAFE D14.22a report

Spasov, I., Kolev, N., Zheleva, N., Todorova, G., Jimenez, J., Herrero, J.J., Cuervo, D., 2012, VVER MSLB benchmark solutions with CRONOS/FLICA and COBAYA/FLICA, NURISP D3.1.3.3a-Rev1 report, 2011; Rev2, 2012

Spasov, I., Tzanov, T., Kolev, N.P., Hádek, J., 2011, DYN3D/FLOCAL vs. COBAYA3/FLICA4 solutions of the VVER-1000 MSLB benchmark, Proc. AER Conf. on VVER Reactor Physics and Safety, Dresden, 19-23 September, 2011

Todorova, G., Petrov, N., Kolev, N., Hugot, F-X., 2009, 2D core solutions for VVER-1000 with APOLLO2 and TRIPOLI4, Proc. AER 2009 Conf, Varna, MTA Atomenergia Press, Budapest (2009)

Todorova, G., Petrov, N., Zheleva, N., Kolev, N., 2011, Advanced calculation schemes and cross-section library generation in hexagonal geometry with APOLLO2, 21st Symposium of AER on VVER Reactor Physics and Reactor Safety, Dresden, Germany, 19-23 September, 2011

List of figures

FIGURE 0.1 - the NURESIM roadmap

FIGURE 0.2 - the NURESIM platform

FIGURE 1 - the NURESAFE consortium

FIGURE 2 - the YACS user interface

FIGURE 3 - Neutronic power versus time during a boron dilution scenario

FIGURE 4 - Principle of CRONOS2 / FLICA / SCANAIR coupling

FIGURE 5 - Time history of core fission power

FIGURE 6 - COBAYA/FLICA predicted 3D power distribution at time of highest return to power (elevation 3.0 m)

FIGURE 7 - Neutronic and Thermal-hydraulic mesh interpolation using the INTERP tool

FIGURE 8 - Dataflow in the coupling scheme between DYN3D-SUBCHANFLOW

FIGURE 9 - 3x3 Minicore with the central UOX-FA containing the control rods

FIGURE 10 - Comparison of the predicted total power of the minicore by the two coupled codes

FIGURE 11 - Large Scale Test Facility

FIGURE 12 - Measurement rakes in clod leg A

FIGURE 13 - Coupled model of the LSTF

FIGURE 14 - Temperature distribution in cold leg A

FIGURE 15 - Local temperature at TE1205

FIGURE 16 - Average temperature at RPV inlet

Glossary of abbreviations

- **API** (*Application Programming Interface*) Interface of a computer program that allows its interaction with other software, within the NURESIM platform, with SALOME
- **ATWS:** (*Anticipated Transient Without Scram*)
- **BWR** (*Boiling Water Reactor*)
- **CAD** (*Computer Aided Design*)
- **CFD** (*Computational Fluid Dynamics*): a CFD code solves 3D equations of fluid dynamics
- **CHF** (*Critical heat flux*)
- **CORBA** (*Common Object Request Broker Architecture*) Standard that enables software components written in multiple computer languages and running on multiple computers to work together. The SALOME platform is based upon CORBA.
- **DBA:** (*Design Basis Accident*)
- **DNB** (*Departure from Nucleate Boiling*): Critical Heat Flux that may occur in boiling bubbly flow conditions
- **DNS** (*Direct Numeric Simulation*)
- **ECC** (*Emergency Core Cooling*)
- **EOL** (*End of Life*)
- **FA** (*Fuel assembly*)
- **HPC** (*High Performance Computing*)
- **HZP** (*Hot Zero Power conditions*) One initial condition before a reactor transient
- **LOCA** (*Lost of coolant accident*)
- **LWR** (*Light Water Reactor*)
- **MED** (*Modèle d'Echange de Données*) or *Data Exchange Model*. It is the SALOME standard to exchange numerical fields and meshes
- **MOC** (*Method Of Characteristics*): A flux calculation method in core physics
- **MSLB** (*Main Steam Line Break*)
- **NEA** (*Nuclear Energy Agency*): Agency of the OECD
- **NURESIM** (*Nuclear Reactor SIMulation*): Name of the reference European simulation platform and of an FP6 project
- **PIJ** (*Probability of collision*): A method that can be used to calculate the neutron fluxes distribution inside the fuel assemblies
- **PTS** (*Pressurized Thermal Shock*)
- **PWR** (*Pressurized Water Reactor*)
- **RANS** (*Reynolds Average Navier Stokes*): Fluid dynamic equations resulting from a time or ensemble averaging in a steady flow
- **REA:** (*Rod Ejection Accident*)
- **ROSA:** (*Rig of Safety Assessment*) : name of an Integral Effect Test Facility
- **RPV** (*Reactor Pressure Vessel*)
- **SBLOCA** (*Small Break Loss-of-Coolant Accident*)
- **TSO** (*Technical Support Organization*)
- **VVER** (*Water-Water Energetic Reactor*): Pressurized water reactor with triangular lattice
- **YACS** It is the SALOME supervision module, used to couple codes together