



HAL
open science

Remediation of ^{137}Cs -contaminated concrete gravels by supercritical CO_2 extraction

A. Leybros, N. Segond, Agnès Grandjean

► **To cite this version:**

A. Leybros, N. Segond, Agnès Grandjean. Remediation of ^{137}Cs -contaminated concrete gravels by supercritical CO_2 extraction. *Chemosphere*, 2018, 208, pp.838-845. cea-02339847

HAL Id: cea-02339847

<https://cea.hal.science/cea-02339847>

Submitted on 5 Nov 2019

HAL is a multi-disciplinary open access archive for the deposit and dissemination of scientific research documents, whether they are published or not. The documents may come from teaching and research institutions in France or abroad, or from public or private research centers.

L'archive ouverte pluridisciplinaire **HAL**, est destinée au dépôt et à la diffusion de documents scientifiques de niveau recherche, publiés ou non, émanant des établissements d'enseignement et de recherche français ou étrangers, des laboratoires publics ou privés.

1 Remediation of ¹³⁷Cs-contaminated concrete rubble by supercritical CO₂ 2 extraction

3
4 Antoine Leybros^{a*}, Nathalie Segond^b, Agnès Grandjean^a

5
6 ^a CEA, DEN, DE2D, SEAD, LPSD, F30207 Bagnols sur Cèze, France

7 ^b AREVA Back-end BG- D&S BU, F92084 la Defense, France

8
9 * *Corresp. author.*; Tel: +(33) 04 66 79 16 41; E-mail: antoine.leybros@cea.fr

10 11 **Highlights**

- 12
- 13 • Supercritical CO₂ was used as solvent to extract ¹³⁷Cs from concrete rubble.
- 14 • The best extractant system was found to be CalixOctyl/HPFOA.
- 15 • Extraction is hindered by carbonation reducing the porosity of the cement.
- 16 • Poor Cs desorption also explained by formation of insoluble Cs-concrete complexes.
- 17 • Preceding extraction with HNO₃ leaching increased the extraction yield up to 55%.

18 19 **Abstract**

20 The removal of cesium contamination is a critical issue for the recycling of concrete rubble in
21 most decommissioning operations. The high solvent strength and diffusivity of supercritical
22 CO₂ make it an attractive choice as vector for extractant system in this context. Experimental
23 extraction runs have been carried out in a radioactive environment on rubble contaminated
24 with ¹³⁷Cs. The best extraction system was found to be CalixOctyl (25,27-Bis(1-
25 octyloxy)calix[4]arene-crown-6, 1,3-alternate) with pentadecafluorooctanoic acid as a

26 modifier. The effects of various operating parameters were investigated, namely the
27 coarseness of rubble, the temperature of supercritical CO₂, the residual water and initial
28 cesium concentrations, and the amounts of extractant and modifier used. The yields from
29 direct extraction were low (< 30%), because of the virtually irreversible sorption of Cs in
30 concrete. The best extraction yield of ~55% was achieved by leaching concrete rubble with
31 nitric acid prior to supercritical CO₂ extraction.

32

33 **Keywords:** supercritical CO₂, metal extraction, calixarene, concrete rubble

34 **1. Introduction**

35 Concern has been growing worldwide about the presence of contamination from years
36 of industrial activities during which toxic substances were improperly handled, stored and
37 disposed. In March 2011, the Fukushima Daiichi nuclear accident led to the release of large
38 quantities of radionuclides, with the total amounts of ^{137}Cs and ^{131}I released estimated to be
39 approximately $1.5 \cdot 10^{17}$ Bq and $1.3 \cdot 10^{16}$ Bq, respectively (Kato et al., 2012). The presence of
40 these elements in the natural environment is concerning as they present both external and
41 internal exposure risks. In this context, the DEMETERRES project was set up to develop
42 innovative and environmentally-friendly processes for ex situ and in situ treatments to extract
43 radionuclides and especially Cs.

44 Most decommissioning projects involve the treatment of contaminated concrete rubble.
45 The total amounts of primary and secondary waste generated vary greatly between
46 decontamination processes (Kaminski et al., 2015) and the best choice depends on what the
47 final objectives are: reducing the dose rate before another treatment or declassification for
48 surface storage or suppressing any trace of contamination for rehabilitation and reuse. The
49 choice of a decontamination process depends essentially on the nature of the matrix to be
50 treated and on the nature of different radionuclides to extract. Cesium for example is very
51 difficult to desorb from concrete rubble because sorption inside the concrete structure is
52 virtually irreversible and because it forms insoluble complexes with calcium silicate hydrate
53 gels (Real et al., 2002). Mechanical, thermal and chemical (such as gel (Castellani et al.,
54 2014) and foam (Dame et al., 2005)) processes can be used to remove surface contamination
55 to a certain depth but the main drawback of these techniques is that they destroy a part of the
56 concrete matrix.

57 Concrete can also be decontaminated using physicochemical processes such as
58 leaching or hydrothermal treatments, whose main advantage is that they preserve the rubble
59 matrix. There have been a number of studies on this topic regarding the treatment of

60 construction materials (Samuleev et al., 2013), granite (Wang et al., 2010), dredged sediments,
61 shales (Sandalls, 1987), ashes (Parajuli et al., 2013) and cemented waste (Reynier et al., 2015).

62 Supercritical CO₂ treatments are a promising alternative that also preserve the
63 structure of the concrete. Supercritical CO₂ is used in a wide range of extraction processes
64 because it is nontoxic, inexpensive, environmentally friendly, and has a low critical
65 temperature and pressure (McHugh and Krukoniš, 1994). Supercritical CO₂ exhibits both high
66 solvent strength and diffusivity, which facilitate extraction in porous structures. Supercritical
67 CO₂ has already been investigated for the extraction of metals (Lin et al., 2014). However, a
68 crucial issue for these processes is the availability of an efficient and selective extractant that
69 is soluble in supercritical CO₂.

70 The three classes of chemicals that are generally used for cesium removal by liquid-
71 liquid extraction are dicarbollides, crown ethers and calixarenes (Dozol et al., 2000).
72 Dicarbollides have a good extraction capacity for cesium, but their selectivity for cesium over
73 other alkali elements is low. In the same way, crown ethers, whose selectivity is based on
74 cation size (macrocycle cavity size complementarity), are poorly selective in the presence of
75 other alkali species. Crown ethers with modifiers (such as di-(2-ethylhexyl) phosphoric acid
76 (HDEHP), pentadecafluorooctanoic acid (HPFOA) or tetraethylammonium perfluorooctane
77 sulfonate (PFOSANet₄)) have been evaluated for the recovery of cesium from aqueous
78 solutions containing other alkali ions such as Na⁺ or K⁺ (Lee et al., 1986) and from synthetic
79 soil samples using supercritical CO₂ (Park et al., 2015). Elsewhere, Lamare et al. (1997) used
80 calixarenes functionalized with crown ethers to extract cesium from a sodium nitrate solution.
81 They found that the selectivity of these compounds for cesium was highly dependent on the
82 conformation of the calixarenes. Indeed, CalixOctyl (25,27-Bis(1-octyloxy)calix[4]arene-
83 crown-6, 1,3-alternate) is remarkably selective in forming complexes with cesium rather than
84 other alkali species in acidic environments (Rais et al., 2015). In the other hand, the solubility
85 of calixarenes in supercritical CO₂ has been measured at 60°C and 20 MPa to be between 0.1

86 and 120 mmol·L⁻¹ depending on their functionalization (Glennon et al., 1997). These
87 properties have led to their use for the supercritical CO₂ extraction of Cs (Kanekar et al.,
88 2014), Cd (Rathod et al., 2015), Pb (Rathod et al., 2014) and U (Rao et al., 2013).

89 As extractant/Cs complexes are almost completely insoluble in supercritical CO₂, an
90 organic modifier is required to neutralize the charge of the complex and increase its solubility.
91 The importance of interfacial phenomena between the supercritical CO₂ phase and the
92 aqueous phase for CalixOctyl/modifier/Cs has been highlighted by molecular dynamics
93 simulations (Schurhammer et al., 2001; Sieffert et al., 2006). The organic modifier used in
94 most cases is HPFOA with macrocyclic polyethers. Extraction yields up to 60% have been
95 obtained with a good selectivity for cesium over potassium cations (Mochizuki et al., 1999;
96 Wai et al., 1999).

97 Cesium decontamination studies have been carried out previously using supercritical
98 CO₂ from silica soil (Leybros et al., 2016). Satisfactory yields of between 70 and 95% were
99 achieved with (non-radioactive) cesium ¹³³Cs concentrations much greater (1–14 mg/g) than
100 observed in practice for ¹³⁷Cs contaminations. This paper reports experimental extraction runs
101 with realistic ¹³⁷Cs activities (~800 Bq/g) performed in a nuclear laboratory on concrete
102 rubble. The extractant considered was CalixOctyl with an organic modifier. The first step of
103 the study consisted in determining the most suitable modifier. The influence of various
104 operating parameters was investigated before the efficiency of supercritical CO₂ extraction
105 was compared for this application with leaching using water and nitric acid. Supercritical
106 extraction complemented by acid leaching was also considered.

107

108 **2. Materials and methods**

109

110 *2.1. Reagents*

111 Calixarenes are macrocyclic compounds formed by the condensation of a phenol
112 and an aldehyde. They have hydrophobic cavities which can accommodate small molecules or
113 ions. The selectivity of calixarenes stems from the size of their cavities and the nature of their
114 functionalization. Crown calixarenes have a much higher selectivity for cesium over other
115 alkali cations than crown ethers do (Danil de Namor et al., 1998), the most selective
116 calixarenes being CalixOctyl (25,27-Bis(1-octyloxy)calix[4]arene-crown-6, 1,3-alternate),
117 shown in **Fig. 1**. The calixarene structure stiffens the whole molecule through steric effects
118 that fix the size of the crown ether's cavity. CalixOctyl was synthesized following Casnati et
119 al. (1995) and its purity (> 95%) was verified by ^1H and ^{13}C NMR and IR spectroscopy. The
120 solubility of this calixarene in CO_2 is about $0.64 \text{ kg}\cdot\text{m}^{-3}$ at 27 MPa and 40°C (Dartiguelongue
121 et al., 2017).

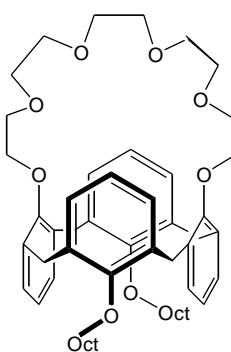

122
123 **Fig. 1.** Chemical structure of CalixOctyl (25,27-Bis(1-octyloxy)calix[4]arene-crown-6, 1,3-
124 alternate).



125
126 The organic modifiers considered in this study were HDEHP, bromocapric acid,
127 HPFOA, formic acid, perfluoropentanoic acid (PFPEA), methyloxvaleric acid,
128 heptadecafluorooctanesulfonic acid (PFOS) and PFOSAN Et_4 . The characteristics of these
129 chemicals are summarized in **Table 1**. No further purification was performed. These
130 modifiers are generally highly soluble in supercritical CO_2 under the conditions used here
131 (Byun et al., 2000; Dartiguelongue et al., 2016; Meguro et al., 1998; Shimizu et al., 2006).

132 Carbon dioxide (> 99.99% purity) was obtained from Air Liquide and used without further
 133 purification.

134

135 **Table 1**

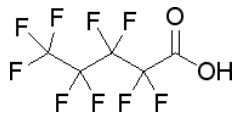
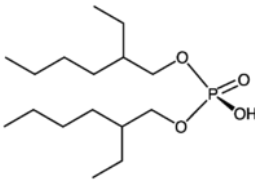
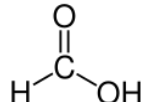
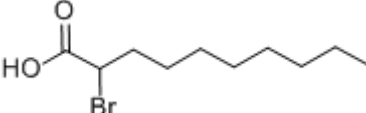
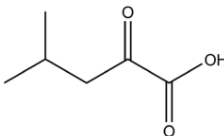
136 Chemical structure and purity of the modifiers used in this study.

Chemical name	CAS N°	Source	Chemical formula/structure	Purity (wt%)
HPFOA	335-67-1	Aldrich		0.96
PFPEA	2706-90-3	Aldrich		0.97
HDEHP	298-07-7	Aldrich		0.97
Formic acid	64-18-6	Aldrich		0.96
2-bromodecanoic acid	2623-95-2	Aldrich		0.96
4-methyl-2-oxovaleric acid	816-66-0	Aldrich		0.98
PFOS	1726-23-1	Aldrich		0.40 in water

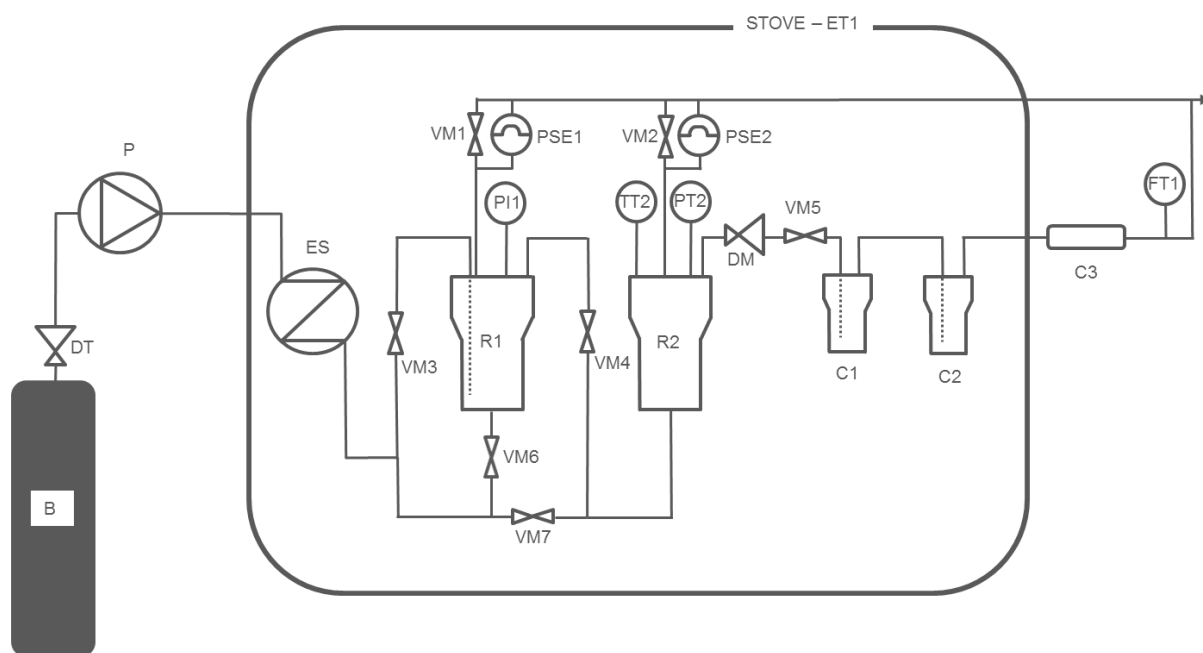

157

158 **Fig. 2.** Schematic diagram of the setup used for the extraction of cesium using supercritical
 159 CO₂. VM: stop valve; P: pump; ES: heat exchanger; R1: solubilization reactor; R2: extraction
 160 reactor; DM: back-pressure regulator; C1, C2 and C3: collectors.

161

162 The extractant and modifier were loaded in advance into reactor R1, in which they
 163 were solubilized in supercritical CO₂. The reactions with and extraction of Cs occurred in
 164 reactor R2, which contained one of the samples of contaminated concrete rubble in an
 165 extraction basket. For the extraction step, the supercritical CO₂ was fed from the bottom of
 166 this basket. The dynamic extraction processes lasted up to 6 h. The CO₂ flow rate from the
 167 feed pump was 10 mL·min⁻¹. A back pressure regulation device (Tescom) was used to set the
 168 operating pressure in the R1 extraction reactor to 27 MPa.

169 This device and procedure are designed to extract cesium in reactor R2 as an
 170 organometallic complex (Cs/extractant/modifier). The Cs was then recovered in the separators
 171 (C1 and C2) held at a lower pressure (0.1 MPa) to reduce the solvating power of the CO₂. The
 172 C3 collector trapped any trace amounts of cesium complex that remained in the gas stream
 173 after depressurization.

174 2.3. Leaching experiments

175 Leaching experiments were performed at ambient temperature using 45 mL of either
176 water or 3 mol·L⁻¹ HNO₃. The rubble samples were leached for 3 h.

177

178 2.4. Protocol for the preparation of cesium-contaminated concrete rubble

179 The samples of contaminated rubble (initial mass, 45 g) were impregnated (fully
180 soaked) with 45 mL of an aqueous solution of ¹³⁷Cs with an activity equal 780 Bq·mL⁻¹ and
181 then dried in a stove until the desired water content (3 wt%) was achieved (**Fig. 3**). The
182 targeted initial activity was 35 kBq. For run 10, in which a cesium activity in the
183 contaminating solution of ~7.8·10⁵ Bq·mL⁻¹ was simulated, an aqueous solution of 3.1·10⁻⁴
184 g·L⁻¹ ¹³³Cs was doped with a 780 Bq·mL⁻¹ ¹³⁷Cs solution. To guarantee the reproducibility of
185 each experiment, the residual water content of the rubble samples was measured as a function
186 of the drying time. Here, the target of residual water contents of around 3 wt% were obtained
187 after 40 h drying at 40 °C.

188

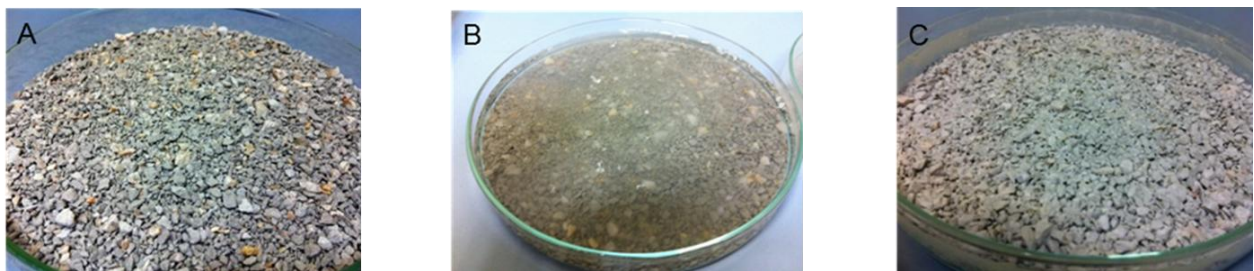

189

190 **Fig. 3.** Preparation of cesium-contaminated rubble. Photographs of (A) their initial state; (B)
191 during impregnation with a ¹³⁷Cs solution and (C) after drying.

192

193 2.4. Analysis

194 The rubble samples were analyzed by γ -ray spectrometry before and after
 195 supercritical CO₂ extraction, as were the extracts collected in the three collectors. The
 196 presence (absence) of ¹³⁷Cs in the extracts reveals the presence (absence) of back-extraction.
 197 The extraction yield of the decontamination process was calculated using **Eq. (1)**,

$$198 \quad E(\%) = \frac{a_{initial} - a_{final}}{a_{initial}} \quad (1)$$

199 where $a_{initial}$ and a_{final} are respectively the activity of the sample (in Bq) before and after the
 200 extraction run.

201 These γ -ray spectrometry measurements were performed using a Tennelec series 5
 202 γ -ray spectrometer (Canberra, USA) equipped with a high-purity germanium detector and a
 203 Tennelec TC242 amplifier. The acquisition software was Interwinner 6.

204 One of the main limitations of this approach is the possible attenuation of the γ
 205 radiation in case of measurement in the solid sample. A calibration curve was therefore
 206 established for the activity of the rubble samples to determine a valid working range. The
 207 rubble samples used as standards were prepared as described above for the extraction
 208 samples, with the same mass, but with targeted activities of 35, 15, 3 and 0.5 kBq. The results
 209 presented in **Table 2** show that γ -ray spectrometry is accurate enough to quantify cesium
 210 extraction efficiencies under these working conditions.

211

212 **Table 2**

213 Nominal versus measured ¹³⁷Cs activity of the standard samples used to validate the
 214 radioactivity measurements performed by γ -ray spectrometry.

	Nominal activity (kBq)	Measured activity (kBq)	Deviation (%)
Sample n°1	35	32.652	7.2

Sample n°2	15	14.202	5.6
Sample n°3	3	2.896	3.6
Sample n°4	0.5	0.421	18.7

215

216

217

218 3. Results and discussion

219 **Table 3** summarizes all the results obtained for each supercritical CO₂ extraction
220 run. We describe first how the best modifier was selected, and then the influence of different
221 operating parameters (particle size, temperature, CalixOctyl/modifier ratio, and residual water
222 content).

223 **Table 3**224 Extraction of cesium from concrete rubble using supercritical CO₂: operating conditions and results.

Run	Modifier	P (MPa)	T (°C)	Molar ratio Cs/Extractant/Modifier	Initial activity (Bq)	Final activity (Bq)	Activity of extracts (Bq)	Extraction yield (%)
1	HDEHP	27.3	43	1/3.4·10 ⁶ /1.0·10 ⁷	33 541 ± 2 415	30 465 ± 2 193	126 ± 24	9.2 ± 7.2
2	Bromocapric acid	27.0	41	1/2.5·10 ⁶ /1.7·10 ⁷	33 525 ± 2 414	32 791 ± 2 361	224 ± 42	2.2 ± 7.2
3	HPFOA	27.3	41	1/3.3·10 ⁶ /1.5·10 ⁷	32 653 ± 2 351	28 650 ± 2 063	448 ± 84	12.3 ± 7.2
4	Formic acid	27.2	41	1/2.9·10 ⁶ /1.5·10 ⁷	33 640 ± 2 422	32 832 ± 2 364	29 ± 5	2.4 ± 7.2
5	PFPEA	27.4	40	1/2.4·10 ⁶ /1.6·10 ⁷	31 649 ± 2 279	29 673 ± 2 136	408 ± 76	6.2 ± 7.2
6	Methyl oxovaleric acid	26.9	41	1/2.5·10 ⁶ /1.2·10 ⁷	32 751 ± 2 358	30 591 ± 2 202	191 ± 36	6.6 ± 7.2
7	PFOS	27.2	42	1/2.0·10 ⁶ /1.0·10 ⁷	32 564 ± 2 345	30 455 ± 2 193	1 143 ± 214	6.5 ± 7.2
8	PFOSA-N(Et)4	27.1	43	1/2.1·10 ⁶ /1.3·10 ⁷	32 970 ± 2 374	31 534 ± 2 270	249 ± 47	5.9 ± 7.2
9 ^a	HPFOA	27.2	43	1/3.1·10 ⁶ /1.1·10 ⁷	33 181 ± 2 389	26 971 ± 1 942	138 ± 26	18.7 ± 7.2
10 ^b	HPFOA	27.5	42	1/2.5·10 ³ /1.1·10 ⁴	32 139 ± 2 314	25 081 ± 1 806	1 225 ± 229	22.0 ± 7.2
11	HPFOA	27.3	57	1/2.4·10 ⁶ /1.1·10 ⁷	33 041 ± 2 379	28 177 ± 2 029	996 ± 186	14.7 ± 7.2
12 ^c	HPFOA	27.1	42	1/2.7·10 ⁶ /1.0·10 ⁷	29 232 ± 2 105	23 536 ± 1 695	1 511 ± 283	19.5 ± 7.2

13	HPFOA	26.6	101	$1/2.1 \cdot 10^6 / 1.0 \cdot 10^7$	$33\,399 \pm 2\,405$	$27\,563 \pm 1\,985$	414 ± 77	17.5 ± 7.2
14 ^d	HPFOA	27.0	40	$1/2.0 \cdot 10^6 / 1.0 \cdot 10^7$	$33\,031 \pm 2\,378$	$25\,678 \pm 1\,849$	184 ± 34	22.3 ± 7.2
15 ^c	HPFOA	26.4	64	$1/2.2 \cdot 10^6 / 1.1 \cdot 10^7$	$33\,038 \pm 2\,378$	$24\,261 \pm 1\,747$	63 ± 12	26.5 ± 7.2
16	HPFOA	27.1	43	$1/6.6 \cdot 10^6 / 3.0 \cdot 10^7$	$32\,981 \pm 2\,375$	$27\,277 \pm 1\,964$	$1\,325 \pm 248$	17.3 ± 7.2
17	HPFOA	26.8	58	$1/2.8 \cdot 10^6 / 2.0 \cdot 10^7$	$32\,648 \pm 2\,351$	$28\,372 \pm 2\,043$	261 ± 49	13.1 ± 7.2

225 HDEHP, bis(2-ethylhexyl)phosphate; HPFOA, pentadecafluorooctanoic acid; PFPEA, perfluoropentanoic acid; PFOS, heptadecafluorooctanesulfonic acid; PFOSA-NEt₄,
 226 tetraethylammonium heptadecafluorooctanesulfonate.

227 Unless otherwise specified, the samples contained particles 2–5 mm in diameter, with an initial ¹³⁷Cs concentration of $2.7 \cdot 10^{-7} \text{ mg} \cdot \text{g}^{-1}$ and a residual water content of 3 wt%.

228 ^aThe particles in this sample were between 1 and 2 mm in diameter.

229 ^bThe initial cesium concentration in this sample was $2.7 \cdot 10^{-4} \text{ mg} \cdot \text{g}^{-1}$.

230 ^cThe residual water content of this sample was 2 wt%.

231 ^dThe residual water content of this sample was 1 wt%.

232

233

234

235 *3.1. Determining the most suitable extractant/modifier system*

236 CalixOctyl was combined with different modifiers in supercritical CO₂ (at 27 MPa,
237 40 °C; Runs 1–8 in **Table 2**). Indeed, CalixOctyl is little soluble in our working conditions and
238 the most suitable modifier has to be identified to enhance both extractant system and
239 organometallic complexes solubilities. As shown in **Table 2**, these runs were performed with
240 a high stoichiometric excess of the extractant, given the very small amount of ¹³⁷Cs present in
241 the samples. The extraction yields were low, between 2 and 12%. The extracts in the
242 collectors were found to have a low activity (between 10 and 500 Bq), whatever the modifier.
243 The modifier that gave the highest extraction yield was HPFOA (12.3%, Run 3). This can be
244 explained by the high solubility of fluorinated compounds in supercritical CO₂, which stems
245 from the presence of fluorine substituents and the length of the fluorinated chain (Smart et al.,
246 1997). Furthermore, the low pKa of fluorinated compounds (Goss, 2008) facilitates ion
247 exchange with cesium inside the concrete.

248 Low extraction yields are expected for concrete rubble because of their chemical
249 structure: cesium cations are strongly adsorbed on their calcium silicate hydrate structure
250 (Evans, 2008). This virtually irreversible ion exchange process and the formation of insoluble
251 complexes with calcium silicate hydrate make cesium desorption (and therefore extraction)
252 very difficult. Moreover, the concentration of alkali ions (Na⁺; K⁺) was significantly higher (a
253 few mmol per gram of concrete as determined by inductively coupled plasma atomic emission
254 spectroscopy) than the Cs⁺ concentration in the samples (a few pmol per gram), which makes
255 strong competition between Cs and other alkali cations.

256 Another factor that may contribute to the low extraction yields is accelerated
257 carbonation, which reduces the size of the pores inside the concrete structure (Garcia-
258 Gonzalez et al., 2008). The rubble samples were found to be between 0.5 and 2.3 g heavier
259 after extraction. **Fig. 4** shows the thermogravimetric analysis of a rubble sample treated by

260 supercritical CO₂ for 4 h at 27 MPa and 40 °C. The presence of a calcite peak (at 760–770 °C)
261 confirms that carbonation has occurred (Villagran-Zaccardi et al., 2017). This suggest that the
262 pores inside the concrete do indeed shrink, trapping the organometallic
263 CalixOctyl/modifier/Cs complexes formed therein. CO₂-philic extractants, more soluble in
264 supercritical CO₂, may therefore be a more suitable choice to extract cesium from the concrete
265 matrix before carbonation.
266

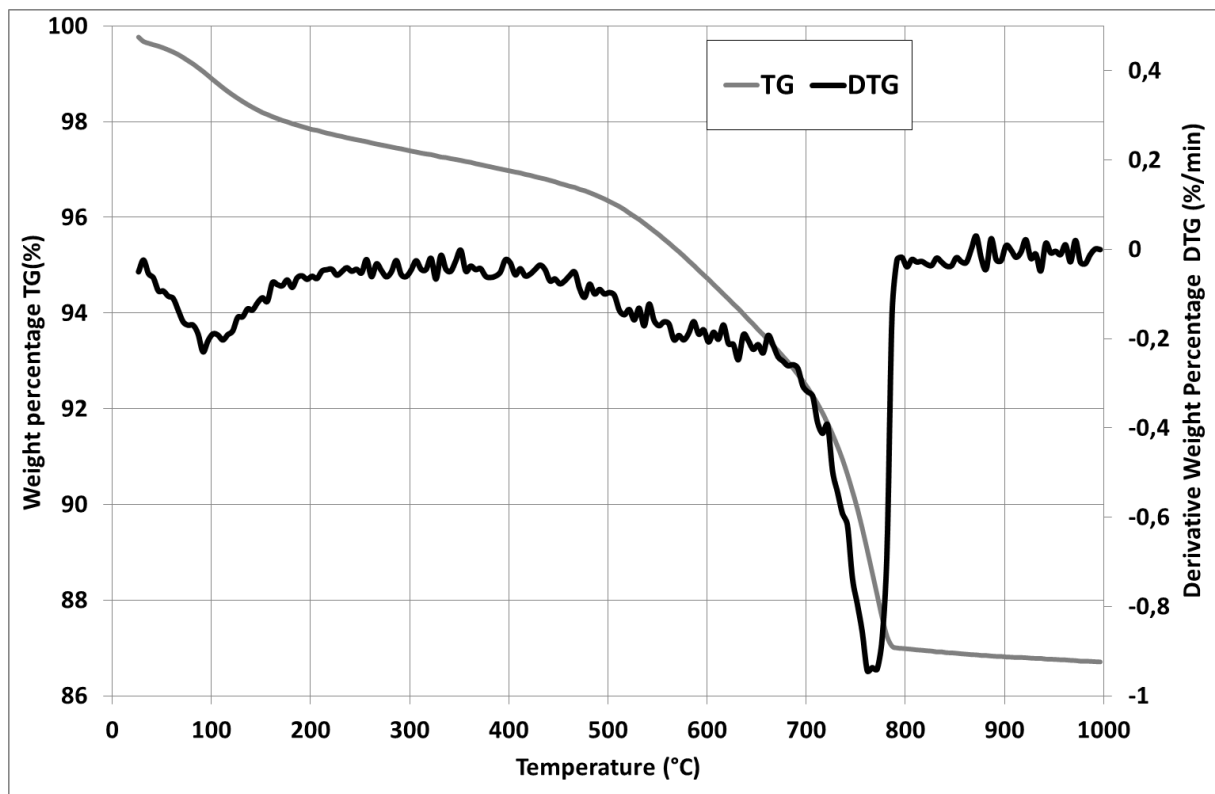

267
268 **Fig. 4.** Demonstration of the formation of calcite in a sample of concrete rubble.
269 Thermogravimetric analysis of a sample of concrete rubble after treatment using supercritical
270 CO₂ (P = 27 MPa; T = 40°C; CO₂ flow = 10 g·min⁻¹, treatment time = 4 h).

271
272 Our results are similar to those of Kanekar et al. (2014), who extracted cesium from
273 soils using supercritical CO₂ and calixarene mixed with methanol. The efficiency of extraction

274 processes such as these can be improved by tuning the operating parameters to find the best
275 compromise between thermodynamic and kinetic limiting factors.

276

277 *3.2. Optimizing the operating parameters*

278 Having identified CalixOctyl/HPFOA as the most suitable extractant system, the
279 following paragraphs describe the effects on the process efficiency of the particle size in the
280 samples (section 3.2.1), of the initial cesium concentration and the Cs/extractant
281 stoichiometric ratio (section 3.2.2) and of the temperature and residual water content (section
282 3.2.3).

283

284 *3.2.1. Role of rubble particle size*

285 Comparing the results obtained for Runs 3 and 9 (**Table 3**) shows that reducing the
286 rubble particle size from 2–5 mm to 1–2 mm (all other parameters being identical) leads to a
287 modest increase in the extraction yield from $12.3 \pm 7.2\%$ to $18.7 \pm 7.2\%$. This effect is
288 expected because smaller particles have a larger specific surface area, making the cesium
289 binding sites in the concrete pores more accessible. The energetic cost of crushing the rubble
290 should be considered however in choosing the best particle size in view of industrialization of
291 the process.

292

293 *3.2.2. Cesium content and amounts of extractant and modifier*

294 Run 3 was repeated in Run 10 but with a much higher cesium concentration initially
295 present in the concrete rubble sample ($2.7 \cdot 10^{-4} \text{ mg} \cdot \text{g}^{-1}$ versus $2.7 \cdot 10^{-7} \text{ mg} \cdot \text{g}^{-1}$, **Table 3**). In
296 the latter case, $^{133}\text{CsNO}_3$ was added to simulate a rubble radioactivity of $10^6 \text{ Bq} \cdot \text{mL}^{-1}$, which
297 is in the range of the levels of contamination observed in practice. The extraction efficiency
298 measured for Run 10 was $22.0 \pm 7.2\%$ compared with $12.3 \pm 7.2\%$ for Run 3. This suggests
299 that the selectivity of the process for Cs over other alkali metal ions is not perfect.

300 The influence on the extraction yield of the amounts of extractant/modifier
301 (CalixOctyl/HPFOA) used was investigated in Run 16, performed with twice the amount of
302 extractant as Run 3 (all other parameters being equal, including the CalixOctyl/HPFOA molar
303 ratio at 1/5). **Table 3** shows that this has little effect on the extraction yield ($17.3 \pm 7.2\%$ for
304 Run 16 versus $12.3 \pm 7.2\%$ for Run 3). The extraction capacity (the ratio of the amount of Cs
305 extracted from the sample over the amount of extractant (CalixOctyl) used) was higher for
306 Run 3 ($5.5 \cdot 10^{-8}$ versus $3.3 \cdot 10^{-8}$ for Run 16). This suggests that the limiting factor here is the
307 low Cs concentration in the rubble, which makes the probability of Cs–extractant interactions
308 very low even when the amount of extractant used is increased.

309 The results for Run 17 show that increasing the ratio between extractant and
310 modifier from 1/5 (Run 11) to 1/7 (Run 17) had little effect on the extraction yield ($13.1 \pm$
311 7.2% for Run 17 versus $14.7 \pm 7.2\%$ for Run 11). This may be because the HPFOA molecules
312 self-associate in supercritical CO₂, which limits their solubility. This effect has been observed
313 previously for fluorocarboxylic acids in supercritical CO₂ (Dartiguelongue et al., 2016).
314 Further investigations are in progress to determine whether the structure of the complexes
315 formed by the extractant system may involve a molecule of calixarene and fluorocarboxylic
316 acid monomers or dimers.

317

318 *3.2.3. Operating temperature and rubble water content*

319 Previous studies on supercritical CO₂ extraction in porous media have demonstrated
320 that the solvent strength and diffusivity of CO₂ are strongly dependent on its density
321 (Anitescu and Tavlarides, 2006). In Runs 3 and 11–15 (**Table 3**), the operating temperature
322 was varied between 40 and 100 °C with a rubble water content of either 1 wt% (Run 14) 2
323 wt% (Runs 12 and 15) or 3 wt% (Runs 3 and 11–13) (**Fig.5**). Note that calixarene was found
324 to be chemically stable at temperatures up to 150 °C. Increasing the temperature up to 100 °C
325 did not significantly affect the extraction yield (which varied from $12.3 \pm 7.2\%$ to $17.5 \pm$

326 7.2%, see **Table 3**). The solvent strength of CO₂ is lower at higher temperatures but this
327 decrease may have been offset by an increase in the extraction kinetics and reduced concrete
328 carbonation.

329

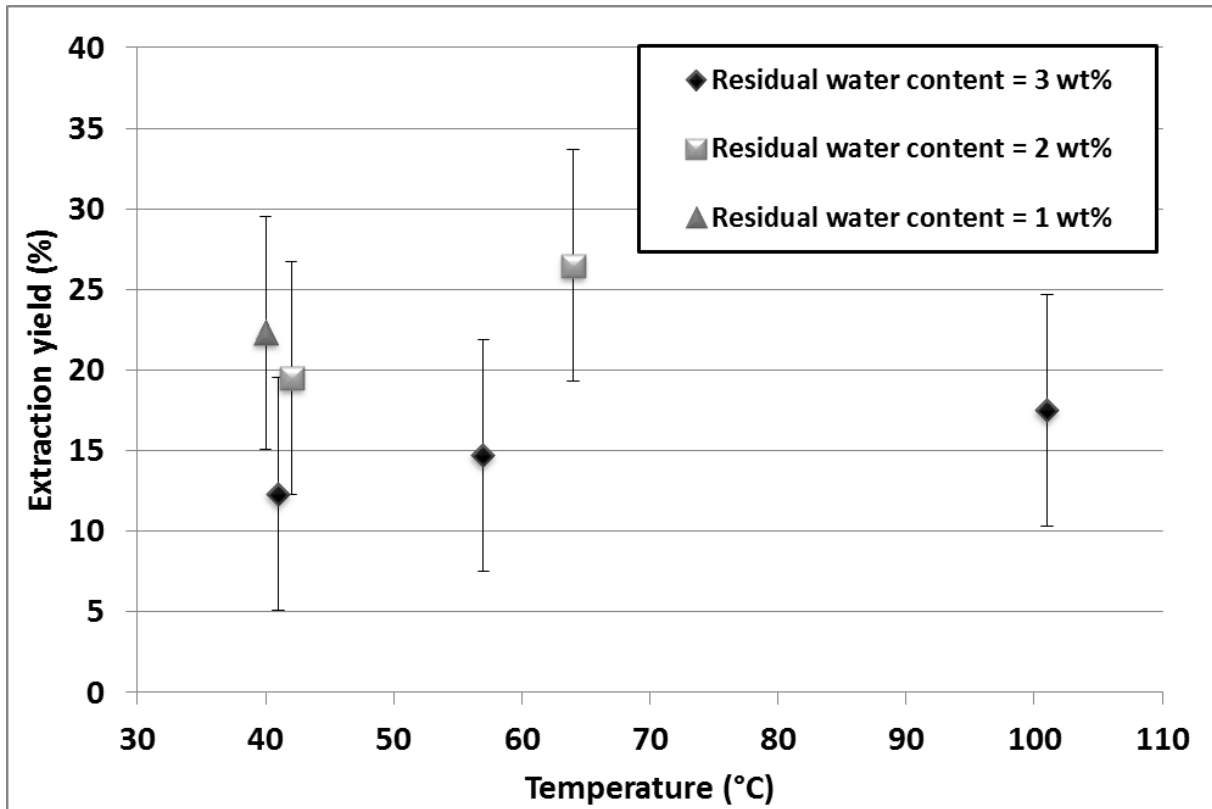

330

331 **Fig. 5.** Influence of residual water content and temperature on extraction yield.

332

333 Reducing the water content of the rubble was found to have a favorable effect on the
334 extraction yield, which was $22.3 \pm 7.2\%$ for Run 14 with 1 wt% water (**Table 3**). It is
335 therefore important to properly dry rubble before proceeding with supercritical CO₂ extraction.

336 These results are in keeping with the literature. Wang et al. (1995) suggest that low water
337 concentrations may promote extraction because this allows hydrogen ions from the modifier
338 to be exchanged with cesium adsorbed in the solid matrix. On the other hand, higher water

339 contents limit extraction because the formation of a water films in the pores may block the
340 supercritical CO₂ and thus limit interactions with the extractant system (Smyth et al., 1999).

341 Moreover, increasing the water content promotes carbonation and therefore reduces the
342 porosity of the concrete (Vance et al., 2015).

343 The best extraction yield of all these runs was $26.5 \pm 7.2\%$ for Run 15, performed at
344 an intermediate temperature (65 °C) and water content (2 wt%). In line with the mechanisms
345 described above, these conditions offer the optimal balance between faster extraction or back-
346 extraction kinetics and slower carbonation on the one hand, and a lower CO₂ solvent strength
347 on the other.

348

349 *3.3. Combining supercritical CO₂ extraction with leaching*

350 Table 4 compares the effects of leaching (with water or HNO₃) with the results
351 obtained using HNO₃ leaching followed by supercritical CO₂ extraction to extract Cs from
352 concrete rubble.

353 **Table 4.**

354 Extraction of cesium from concrete rubble by leaching and by leaching followed by supercritical CO₂ extraction: operating conditions and results.

Run		P (bar)	T (°C)	Molar ratio Cs/Extractant/Modifier	Initial activity (Bq)	Activity of leaching solution (Bq)	Final activity (Bq)	Activity of extracts (Bq)	Extraction yield (%)
18	Water leaching	–	ambient	–	33 152 ± 2 387	4 471 ± 161	26 461 ± 1 905		20.2 ± 7.2
19	HNO ₃ leaching	–	ambient	–	32 482 ± 2 339	17 627 ± 952	16 944 ± 915		47.8 ± 6.3
20	HNO ₃ leaching followed by SCCO ₂ extraction	27.4	40	1/ 2.0.10 ⁶ /1.0.10 ⁷	32 765 ± 2 359	14 074 ± 760	14 861 ± 802	494 ± 92	54.6 ± 6.3

355 SCCO₂, supercritical CO₂

356

357

358 The extraction efficiency of the water leaching run was almost as high as the best
359 supercritical CO₂ extraction (Run 18, 20.2 ± 7.2% and Run 15, 26.5 ± 7.2% respectively).
360 With HNO₃ leaching (Run 19), the extraction yield was much higher (47.8 ± 6.3%). These
361 yields are similar to those of previous studies of the acidic leaching of soil and/or concrete
362 samples (Kim et al., 2007; Samuleev et al., 2013) and show that HNO₃ efficiently desorbs
363 ¹³⁷Cs from otherwise irreversible sorption sites in the concrete pores.

364 A further increase in the extraction yield was obtained by performing supercritical
365 CO₂ extraction after HNO₃ leaching (Run 20, 54.6 ± 6.3%). These results suggest coupling
366 between leaching and supercritical CO₂ extraction by cumulating steps up to reach targeted
367 threshold for rubble activity for reuse or storage. It would be interesting to perform the HNO₃
368 leaching in situ in supercritical CO₂, which may reduce the amount of HNO₃ required and
369 allow the procedure to be performed in a single step. The benefits would be substantial on an
370 industrial scale. The influence of the HNO₃ concentration may also be worth investigating, to
371 find the optimal balance between extraction yields and the corrosion of the pipes and internal
372 walls.

373

374 **4. Conclusion**

375 Supercritical CO₂ extraction runs have been performed on samples of cesium-
376 contaminated concrete rubble, with an extractant system composed of a cesium-selective
377 crown calixarene and a modifier. These experiments were carried out in a radioactive
378 environment with realistic levels of ¹³⁷Cs contamination. Preliminary tests identified the most
379 suitable modifier (HPFOA) to be used in this context with CalixOctyl (the crown calixarene).
380 Experiments performed on rubble with different particle sizes and residual water contents, at
381 different temperatures and with different amounts of cesium and extractant showed that the
382 most important factors were the temperature of the process and the water content of the

383 samples. In choosing the operating conditions, a compromise has to be found between kinetic
384 (for extraction, back-extraction and the carbonation of the concrete), thermodynamic (the
385 solubility of the extractant system and the resulting organometallic compounds) and
386 diffusivity effects. The best cesium extraction yield obtained here using supercritical CO₂
387 extraction alone was $26.5 \pm 7.2\%$. Similar results were obtained by Kanekar et al. (2014) for
388 soil samples using supercritical CO₂ and three calix-crown derivatives in methanol or
389 acetonitrile. An extraction yield of $54.6 \pm 6.3\%$ was obtained by leaching the concrete rubble
390 with nitric acid before the supercritical CO₂ extraction step. Leaching makes the cesium more
391 labile and thus more easily extractable. Our results show furthermore that the benefits of
392 leaching and supercritical CO₂ extraction are cumulative. Further studies are ongoing to
393 synthesize a CO₂-phile and Cs-selective extractant and compare its performance with the
394 CalixOctyl/HPFOA system. Thermodynamic studies of CalixOctyl/HPFOA/CO₂ mixtures
395 may also facilitate the optimization of the operating conditions in view of scaling up the
396 process.

397

398 **Acknowledgements**

399 This work was supported financially through the ANR DEMETERRES project
400 (Investissements d'avenir, Grant n°ANR-11-RSNR-0005). The authors thank Emmanuel
401 Humbel, Amélys Venditti and Pierre Venditti for technical help.

402

403 **References**

404

405 Anitescu, G., Tavlarides, L., 2006. Supercritical extraction of contaminants from soils and
406 sediments. *J. Supercrit. Fluids.* 38, 167–180. <https://doi.org/10.1016/j.supflu.2006.03.024>

407 Byun, H.S., Kim, K., McHugh, M.A., 2000. Phase behavior and modeling of supercritical
408 carbon dioxide-organic acid mixtures. *Ind. Eng. Chem. Res.* 39, 4580–4587.

409 <http://dx.doi.org/10.1021/ie0001164>

410 Castellani, R., Poulesquen, A., Goettmann, F., Marchal, P., Choplin, L., 2014. A topping gel
411 for the treatment of nuclear contaminated small items. *Nucl. Eng. Des.* 278, 481-490.

412 <http://dx.doi.org/10.1016/j.nucengdes.2014.07.043>

413 Casnati, A., Pochini, A., Ungaro, R., Ugozzoli, F., Arnaud, F., Fanni, S., Schwing, M.-J.,
414 Egberink, R., de Jong, F.,Reinhoudt, D. N., 1995. Synthesis, complexation, and membrane
415 transport studies of 1,3-alternate calix[4]arene-crown-6 conformers: a new class of cesium
416 selective ionophores. *J. Am. Chem. Soc.* 117, 2767–2777.

417 <http://dx.doi.org/10.1021/ja00115a012>

418 Dame, C., Fritz, C., Pitois, O., Faure, S., 2005. Relations between physicochemical properties
419 and instability of decontamination foams. *Colloids and Surfaces A: Physicochem. Eng.*

420 *Aspects.* 263, 210-218. <http://dx.doi.org/10.1016/j.colsurfa.2004.12.053>

421 Danil de Namor A., Cleverley, R., Zapata-Ormachea, M., 1998. Thermodynamics of
422 calixarene chemistry. *Chem. Rev.* 98, 2495–2525. <http://dx.doi.org/10.1021/cr970095w>

423 Dartiguelongue, A., Leybros, A., Grandjean, A., 2016. Solubility of perfluoropentanoic acid
424 in supercritical carbon dioxide: Measurements and modeling. *J. Chem. Eng. Data.* 61, 3902–
425 3907. <http://dx.doi.org/10.1021/acs.jced.6b00649>

426 Dartiguelongue, A., Leybros, A., Grandjean, A., 2017. Solubility and solution enthalpy of a
427 cesium-selective calixarene in supercritical carbon dioxide. *J. Supercrit. Fluids.* 125, 42–49.

428 <http://dx.doi.org/10.1016/j.supflu.2017.01.017>

429 Dozol, J.F., Dozol, M., Macias, R., 2000. Extraction of strontium and cesium by dicarbollides,
430 crown ethers and functionalized calixarenes. *J. Incl. Phenom. Macrocycl. Chem.* 38, 1–22.
431 <http://dx.doi.org/10.1023/A:1008145814521>

432 Evans, N., 2008. Binding mechanisms of radionuclides to cement. *Cem. Concr. Res.* 38, 545–
433 553. <http://dx.doi.org/10.1016/j.cemconres.2007.11.004>
434

435 Garcia-Gonzalez, C., El Grouh, N., Hidalgo, A., Fraile, J., Lopez-Periago, A., Andrade, C.,
436 Domingo, C., 2008. New insights on the use of supercritical carbon dioxide for the
437 accelerated carbonation of cement pastes. *J. Supercrit. Fluids* 43, 500–509.
438 <http://dx.doi.org/10.1016/j.supflu.2007.07.018>

439 Glennon, J. Hutchinson, S., Harris, S., Walker, A., McKervey, A., McSweeney, C., 1997.
440 Molecular baskets in supercritical CO₂. *Anal. Chem.* 69, 2207–2212.
441 <http://dx.doi.org/10.1021/ac960850q>

442 Goss K., 2008. The pKa values of PFOA and other highly fluorinated carboxylic acids.
443 *Environ. Sci. Technol.* 42, 456–458. <http://dx.doi.org/10.1021/es702192c>

444 Jokic S., Nagy, B., Zekovic, Z., Vidovic, S., Bilic, M., Velic, D., Simandi, B., 2012. Effects
445 of supercritical CO₂ extraction parameters on soybean oil yield. *Food Bioprod. Process.* 90,
446 693–699. <http://dx.doi.org/10.1016/j.fbp.2012.03.003>

447 Kaminski, M., Lee, S., Magnuson, M., 2016. Wide-area decontamination in an urban
448 environment after radiological dispersion: A review and perspectives. *J. Hazard. Mater.* 305,
449 67–86. <http://dx.doi.org/10.1016/j.jhazmat.2015.11.014>

450 Kanekar, A.S., Pathak, P.N., Mohapatra, P.K., 2014. Online recovery of radiocesium from
451 soil, cellulose and plant samples by supercritical fluid extraction employing crown ethers and
452 calix-crown derivatives as extractants. *J. Radioanal. Nucl. Chem.* 300, 1281–1289.
453 <http://dx.doi.org/10.1007/s10967-014-3034-0>

454 Kato, H., Onda, Y., Teremage, M., 2012. Depth distribution of ^{137}Cs , ^{134}Cs and ^{131}I in soil
455 profile after Fukushima Dai-ichi nuclear power plant accident. *J. Environ. Radioact.* 111, 59–
456 64. <http://dx.doi.org/10.1016/j.jenvrad.2011.10.003>

457 Kim, G., Choi, W., Jung, C., Moon, J., 2007. Development of a washing system for soil
458 contaminated with radionuclides around TRIGA reactors. *J. Ind. Eng. Chem.* 13, 406–413.
459

460 Lamare, V., Bressot, C., Dozol, J.F., Vicens, J., Asfari, Z., Ungaro, R., Casnati, A., 1997.
461 Selective extraction of cesium at tracer level concentration from a sodium nitrate solution
462 with calix-crowns. Molecular modeling study of the Cs^+/Na^+ selectivity. *Sep. Sci. Technol.*
463 32, 175–191. <http://dx.doi.org/10.1080/01496399708003193>

464 Lee, I.C., Kim, S. J., Lee, C., 1986. Extraction of alkali metal cation with crown ethers and
465 HDEHP. *J. Korean Chem. Soc.* 30, 359–368.

466 Leybros, A., Grandjean, A., Segond, N., Messalier, M., Boutin, O., 2016. Cesium removal
467 from contaminated sand by supercritical CO_2 extraction. *J. Environ. Chem. Eng.* 4, 1076–
468 1080. <http://dx.doi.org/10.1016/j.jece.2016.01.009>

469 Leybros, A., Hung, L., Hertz, A., Hartmann, D., Grandjean, A., Boutin, O., 2017.
470 Supercritical CO_2 extraction of uranium from natural ore using organophosphorus extractants.
471 *Chem. Eng. J.* 316, 196–203. <http://dx.doi.org/10.1016/j.cej.2017.01.101>

472 Lin, F., Liu, D., Das, S. M., Prempeh, N., Hua, Y., Lu, J., 2014. Recent progress in heavy
473 metals extraction by supercritical CO_2 fluids. *Ind. Eng. Chem. Res.* 53, 1866–1877.
474 <http://dx.doi.org/10.1021/ie4035708>

475 McHugh, M.A., Krukoni, V. J., 1994. Supercritical fluid extraction: Principles and Practice,
476 second ed., Butterworth-Heinemann, Boston.

477 Meguro, Y., Iso, S., Sasaki, T., Yoshida, Z., 1998. Solubility of organophosphorus metal
478 extractants in supercritical carbon dioxide. *Anal. Chem.* 70, 774–779.
479 <http://dx.doi.org/10.1021/ac9707390>

480 Mochizuki, S., Wada, N., Smith Jr., R., Inomata, H., 1999. Perfluorocarboxylic acid counter
481 ion enhanced extraction of aqueous alkali metal ions with supercritical carbon dioxide.
482 *Analyst.* 124, 1507–1511. <http://dx.doi.org/10.1039/A904873A>

483 Parajuli, D., Tanaka, H., Hakuta, Y., Minami, S., Fukuda, K., Umeoka, R., Kamimura, Y.,
484 Hayashi, Y., Ouchi, M., Kawamoto, T., 2013. Dealing with the aftermath of Fukushima
485 Daiichi nuclear accident: decontamination of radioactive cesium enriched ash. *Environ. Sci.*
486 *Technol.* 47, 3800–3806. <http://dx.doi.org/10.1021/es303467n>

487 Park, J., Park, K., Kim, H., 2015. Decontamination techniques of metal ions in soil by
488 supercritical fluid with synthetic ligands in: *Proceedings of Global 2015, Paris*, pp.2114-2121.

489 Rao, A., Rathod, N., Malkhede, D., Raut, V., Ramakumar, K., 2013. Supercritical carbon
490 dioxide extraction of uranium from acidic medium employing calixarenes. *Sep. Sci. Technol.*
491 48, 644–651. <http://dx.doi.org/10.1080/01496395.2012.707731>

492 Rathod, N., Rao, A., Kumar, P., Ramakumar, K., Malkhede, D., 2014. Complexation with
493 calixarenes and efficient supercritical CO₂ extraction of Pb(II) from acidic medium. *New J.*
494 *Chem.* 38, 5331–5340. <http://dx.doi.org/10.1039/C4NJ00927D>

495 Rathod, N., Rao, A., Kumar, P., Ramakumar, K., Malkhede, D., 2015. Studies on
496 complexation and supercritical fluid extraction of Cd²⁺ with calixarenes. *Ind. Eng. Chem. Res.*
497 54, 3933–3941. <http://dx.doi.org/10.1021/ie5045583>

498 Rais, J., Tachimori, S., Yoo, E., Alexova, J., Bubenikova, M., 2015. Extraction of radioactive
499 Cs and Sr from nitric acid solutions with 25,27-Bis(1-octyloxy)calix[4]-26,28-Crown-6 and
500 Dicyclohexyl-18-Crown-6: Effect of nature of the organic solvent. *Sep. Sci. Technol.* 20,
501 1202–1212. <http://dx.doi.org/10.1080/01496395.2014.978464>

502 Real, J., Persin, F., Camaras-Claret, C., 2002. Mechanisms of desorption of ¹³⁴Cs and ⁸⁵Sr
503 aerosols deposited on urban surfaces. *J. Environ. Radioact.* 62, 1–15.
504 [http://dx.doi.org/10.1016/S0265-931X\(01\)00136-9](http://dx.doi.org/10.1016/S0265-931X(01)00136-9)

505 Reynier, N., Lastra, R., Laviolette, C., Fiset, J., Bouzoubaa, N., Chapman, M., 2015.
506 Uranium, cesium and mercury leaching and recovery from cemented radioactive wastes in
507 sulfuric acid and iodide media. *Minerals*. 5, 744–757. <http://dx.doi.org/10.3390/min5040522>
508 Samuleev, P., Andrews, W., Creber, K., Azmi, P., Velicogna, D., Kuang, W., Volchek, K.,
509 2013. Decontamination of radionuclides on construction materials. *J. Radioanal. Nucl. Chem.*
510 296, 811–815. <http://dx.doi.org/10.1007/s10967-012-2146-7>
511 Sandalls, F., 1987. Removal of radiocaesium from urban surfaces. *Radiat. Prot. Dosimetry*.
512 21, 137–140. <http://dx.doi.org/10.1093/oxfordjournals.rpd.a080066>
513 Schurhammer, R., Berny, F., Wipff, G., 2001. Importance of interfacial phenomena in
514 assisted ion extraction by supercritical CO₂: a molecular dynamics investigation. *Phys. Chem.*
515 *Chem. Phys.* 3, 647–656. <http://dx.doi.org/10.1039/B007238I>
516 Shimizu, R., Sawada, K., Enokida, Y., Yamamoto, I., 2006, Decontamination of radioactive
517 contaminants from iron pipes using reactive microemulsion of organic acid in supercritical
518 carbon dioxide. *J. Nucl. Sci. Technol.* 43, 694–698.
519 <http://dx.doi.org/10.1080/18811248.2006.9711150>
520 Sieffert, N., Wipff, G., 2006. Alkali cation extraction by calix[4]crown-6 to room-temperature
521 ionic liquids. The effect of solvent anion and humidity investigated by Molecular Dynamics
522 Simulations. *J. Phys. Chem. A*. 110, 1106–1117. <http://dx.doi.org/10.1021/jp054990s>
523 Smart, N., Carleson, T., Kast, T., Clifford, A., Burford, M., Wai, C, 1997. Solubility of
524 chelating agents and metal containing compounds in supercritical fluid carbon dioxide.
525 *Talanta*. 44, 137–150. [http://dx.doi.org/10.1016/S0039-9140\(96\)02008-5](http://dx.doi.org/10.1016/S0039-9140(96)02008-5)
526 Smyth, T., Zytner, R., Stiver, W., 1999. Influence of water on the supercritical fluid extraction
527 of naphthalene from soil. *J. Hazard. Mater.* 67, 183–196. [http://dx.doi.org/10.1016/S0304-](http://dx.doi.org/10.1016/S0304-3894(99)00043-6)
528 [3894\(99\)00043-6](http://dx.doi.org/10.1016/S0304-3894(99)00043-6)
529 Vance, K., Falzone, G., Pignatelli, I., Bauchy, M., Balonis, M., Sant, G., 2015. Direct
530 carbonation of Ca(OH)₂ using liquid and supercritical CO₂: Implication for carbon-neutral

531 cementation. *Ind. Eng. Chem. Res.* 54, 8908–
532 8918. <http://dx.doi.org/10.1021/acs.iecr.5b02356>
533 Villagran-Zaccardi, Y., Eguez-Alava, H., De Buysser, K., Gruyaert, E., De Belie, N., 2017.
534 Calibrated quantitative thermogravimetric analysis for the determination of portlandite and
535 calcite content in hydrated cementitious systems. *Mater. Struct.* 50, 179-189.
536 <https://dx.doi.org/10.1617/s11527-017-1046-2>
537 Wai, C., Kulyako, Y., Myasoedov, B., 1999. Supercritical carbon dioxide extraction of
538 caesium from aqueous solutions in the presence of macrocyclic and fluorinated compounds.
539 *Mendeleev Commun.* 9, 80–81. <https://doi.org/10.1070/MC1999v009n05ABEH001117>
540 Wang, S., Elshani, J., Wai, C., 1995. Selective extraction of mercury with ionizable crown
541 ethers in supercritical carbon dioxide. *Anal. Chem.* 67, 919–923.
542 <http://dx.doi.org/10.1021/ac00101a019>
543 Wang, T., Li, M., Teng, S., 2010. Desorption of cesium from granite under various aqueous
544 conditions. *Appl. Radiat. Isot.* 68, 2140–2146.
545 <http://dx.doi.org/10.1016/j.apradiso.2010.07.005>
546