



HAL
open science

Mg-Zr alloy corrosion in Na-geopolymer and its synthetic pore solution

E. Schmucker, B. Muzeau, Christian Bataillon

► **To cite this version:**

E. Schmucker, B. Muzeau, Christian Bataillon. Mg-Zr alloy corrosion in Na-geopolymer and its synthetic pore solution. Eurocorr 2018, Sep 2018, Cracovie, Poland. cea-02339308

HAL Id: cea-02339308

<https://cea.hal.science/cea-02339308>

Submitted on 13 Dec 2019

HAL is a multi-disciplinary open access archive for the deposit and dissemination of scientific research documents, whether they are published or not. The documents may come from teaching and research institutions in France or abroad, or from public or private research centers.

L'archive ouverte pluridisciplinaire **HAL**, est destinée au dépôt et à la diffusion de documents scientifiques de niveau recherche, publiés ou non, émanant des établissements d'enseignement et de recherche français ou étrangers, des laboratoires publics ou privés.



Mg-Zr alloy corrosion in Na-geopolymer and its synthetic pore solution

[E. Schmucker](#)¹, B. Muzeau², C. Bataillon¹

¹ Den-Service de Corrosion et du Comportement des Matériaux dans leur Environnement (SCCME), CEA, Université Paris-Saclay, 91191 Gif-sur-Yvette, France

² Den-Service d'Etude du Comportement des Radionucléides (SECR), CEA, Université Paris-Saclay, 91191 Gif-sur-Yvette, France

EUROCORR 2018

9-13 SEPTEMBER 2018

KRAKOW, POLAND

➤ UNGG-Natural Uranium Graphite Gas reactor

- From the 60's until the 90's in France
- Mg alloys used for fuel claddings



➤ Mg alloys wastes conditioning strategy : encapsulation of the Mg-wastes in an hydraulic binder inside a metallic container

- Exposition to alkaline environment
- Contact with graphite (AquaDAG[®]) or steel (container) leading to galvanic coupling

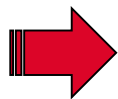

Corrosion of Mg alloys → hydrogen evolution reaction and corrosion products formation

- Introduction

- **Experimental methodology**

- Corrosion of Mg-alloy in Synthetic Pore Solution
 - *General corrosion*

- Corrosion of Mg-alloy in Na-Geopolymer Mortar
 - *General corrosion*
 - *Galvanic corrosion*
 - *Conductivity measurements*

- Conclusion

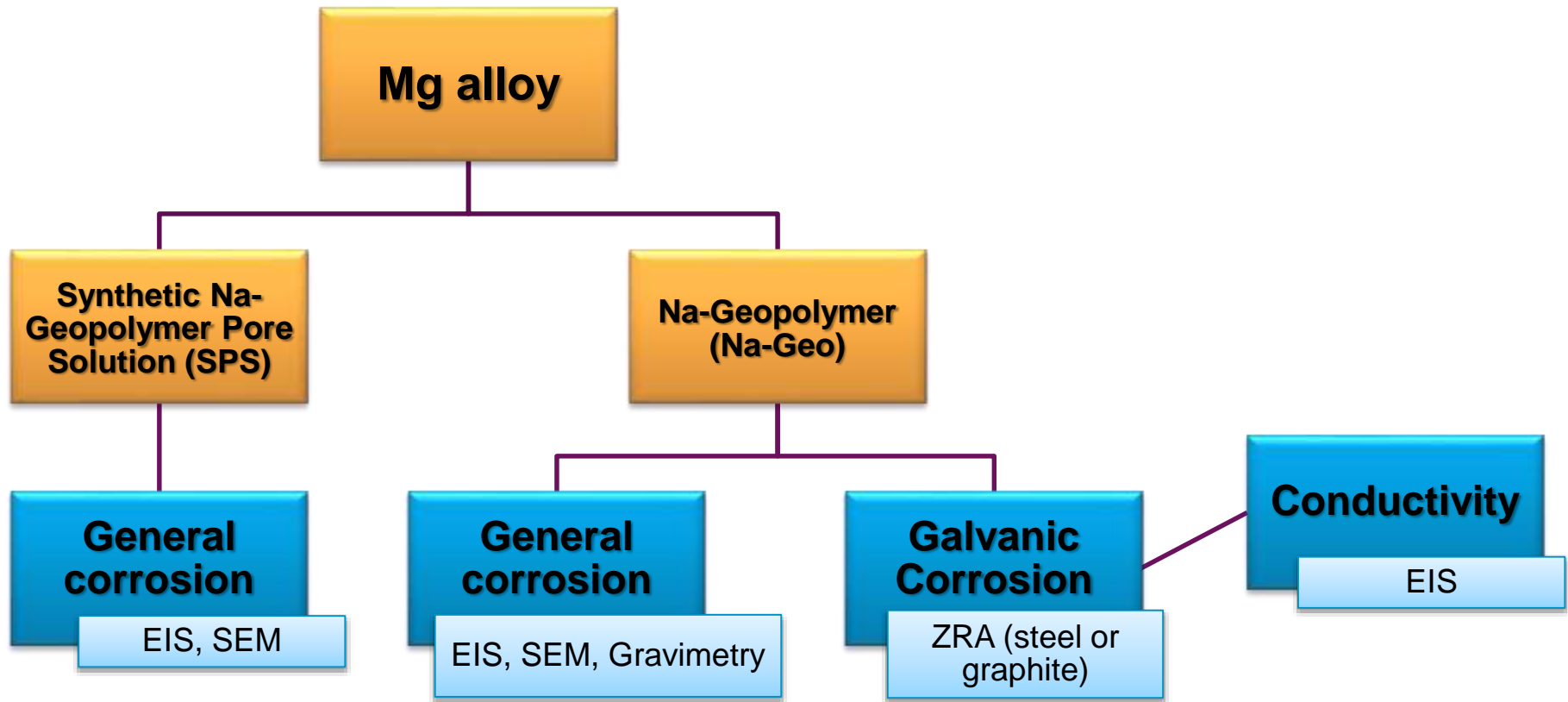

Alloy composition:

Mg-0.5Zr (wt.%)

Na-Geopolymer/NaF mortar:

$1\text{Na}_2\text{O}-3.96\text{SiO}_2-1\text{Al}_2\text{O}_3-12.5\text{H}_2\text{O} + 1.25\text{M NaF}$
+ Sand

Synthetic Pore Solution:

NaF ; $\text{AlF}_3, 3\text{H}_2\text{O}$; KOH ; NaCl ; $\text{Na}_2\text{SO}_4, 10\text{H}_2\text{O}$;
 $\text{NaH}_2\text{PO}_4, \text{H}_2\text{O}$; $\text{Na}_2\text{SiO}_3, 5\text{H}_2\text{O}$

Weight loss
measurements:

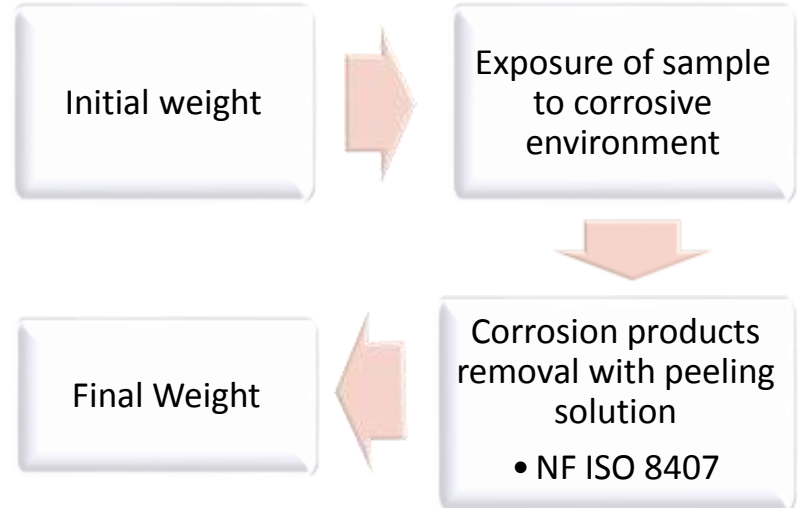

Electrochemical
set-up:

3 electrodes electrochemical cell:

- ⇒ **WE:** Mg-0.5%Zr cylinder (1)
- ⇒ **RE:** Pt wire (2)
- ⇒ **CE:** Ti mesh for general corrosion (3)
S235JR steel or graphite (4) for galvanic corrosion

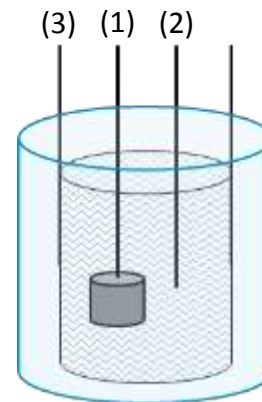

Ecorr / EIS

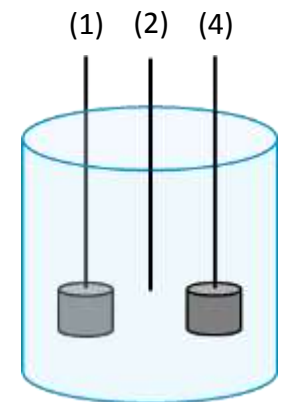

ZRA

- ❑ Introduction
- ❑ Experimental methodology
- ❑ **Corrosion of Mg-alloy in Synthetic Pore Solution**
 - *General corrosion*
- ❑ Corrosion of Mg-alloy in Na-Geopolymer Mortar
 - *General corrosion*
 - *Galvanic corrosion*
 - *Conductivity measurements*
- ❑ Conclusion

Elementary X-ray Mapping - (after 6 months exposure)

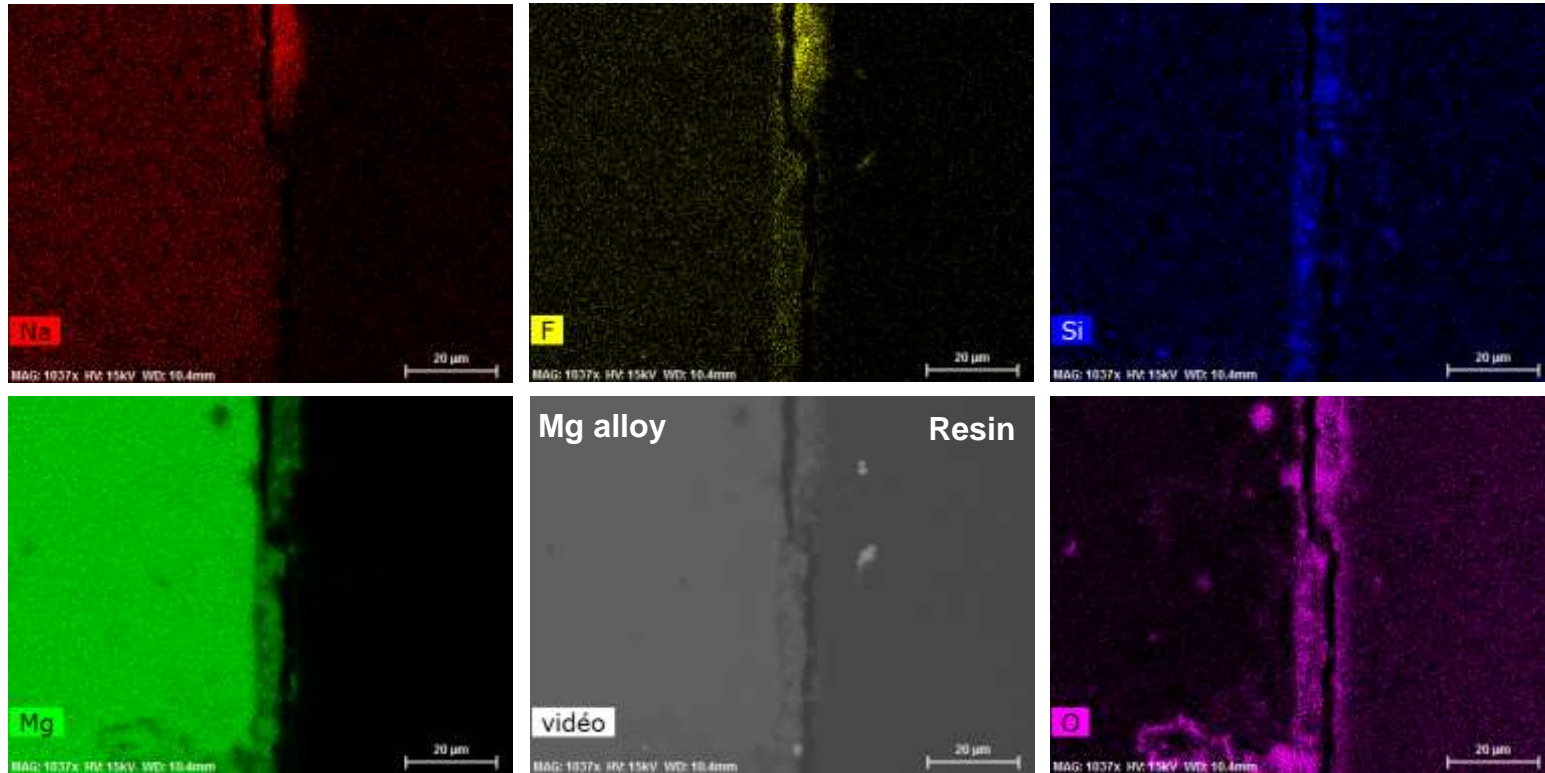

Presence of two different phases: 4-5 µm thick

- Mg and O rich → brucite $Mg(OH)_2$ or MgO
- Mg, O, Na, F rich → mixture of $Mg(OH)_2$, NaF , MgF_2 , $NaMgF_3$, oxyfluorides, silicates... ?

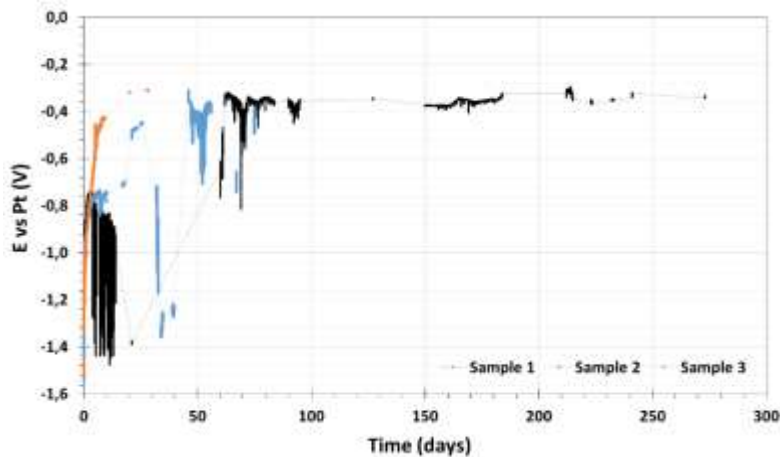

Corrosion potential monitoring:

- Increase to anodic potentials
- Instabilities for short durations

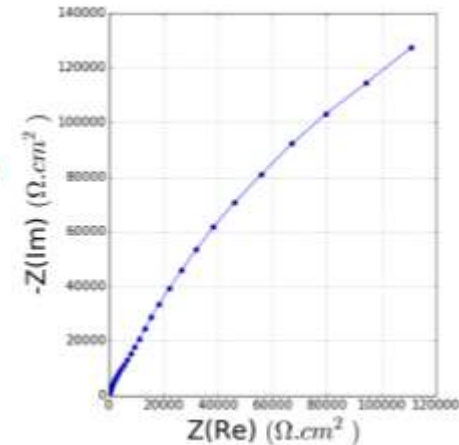
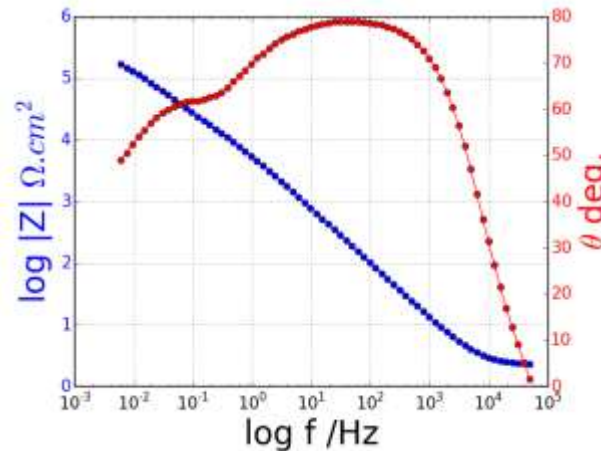

Electrochemical Impedance Spectroscopy:

- 2 capacitive loops
- Analysis and deconvolution with IAO software (developped at CEA-LECA lab)
- Fitting with Simad software (developped at LISE laboratory, UPMC Paris)

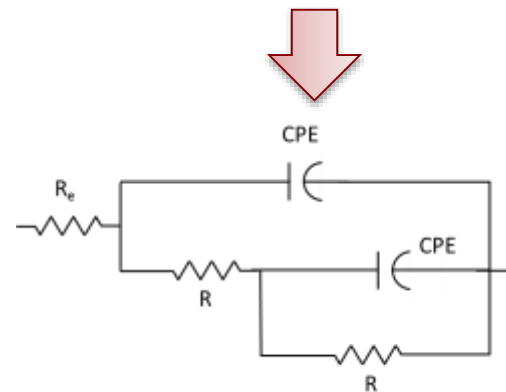

Equivalent circuit
for MgZr / SPS
corrosion modelling

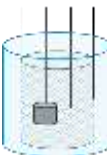

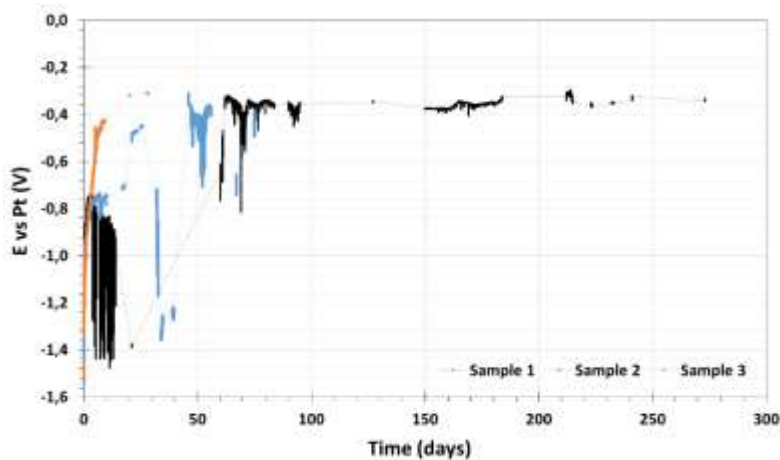

Corrosion potential monitoring:

- Increase to anodic potentials
- Instabilities for short durations

Charge transfer resistance (Rt)

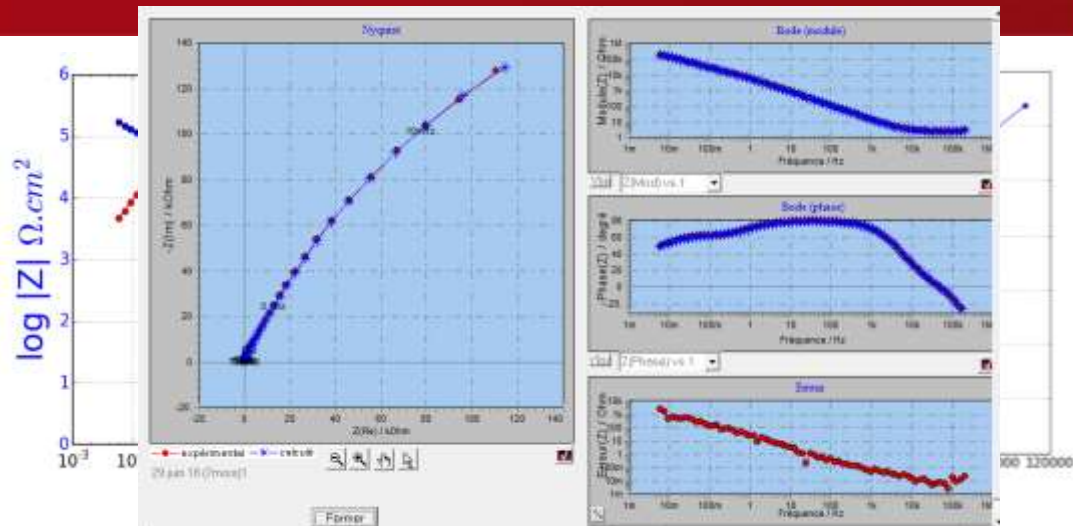
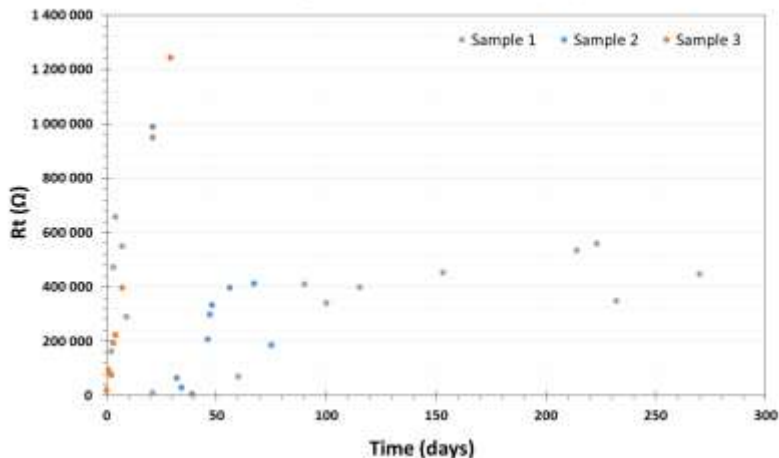

Electrochemical Impedance Spectroscopy:

- 2 capacitive loops
- Analysis and deconvolution with IAO software (developped at CEA-LECA lab)
- Fitting with Simad software (developped at LISE laboratory, UPMC Paris)

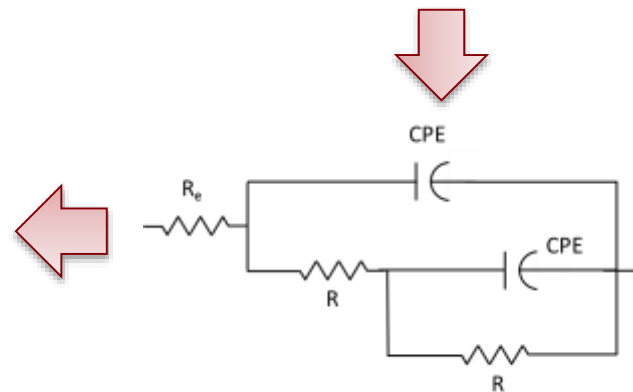

Equivalent circuit
for MgZr / SPS
corrosion modelling

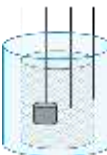

Conclusions

- ❖ Heterogeneous surface film composition
 - Brucite $Mg(OH)_2$ or MgO
 - Na, F, Si rich phase
- ❖ Equivalent circuit with two R//CPE contributions consistent with the film morphology
 - ➔ Further characterisations of the film are still required (Raman, XRD, XPS...)
What is the formation mechanism of the film ?
- ❖ Order of magnitude for corrosion rate $\approx 0.1 \mu\text{m}/\text{year}$
- ❖ Several experiments are required for repetability

- ❑ Introduction
- ❑ Experimental methodology
- ❑ Corrosion of Mg-alloy in Synthetic Pore Solution
 - *General corrosion*
- ❑ **Corrosion of Mg-alloy in Na-Geopolymer Mortar**
 - *General corrosion*
 - *Galvanic corrosion*
 - *Conductivity measurements*
- ❑ Conclusion

Elementary X-ray Mapping (after 6 months exposure)

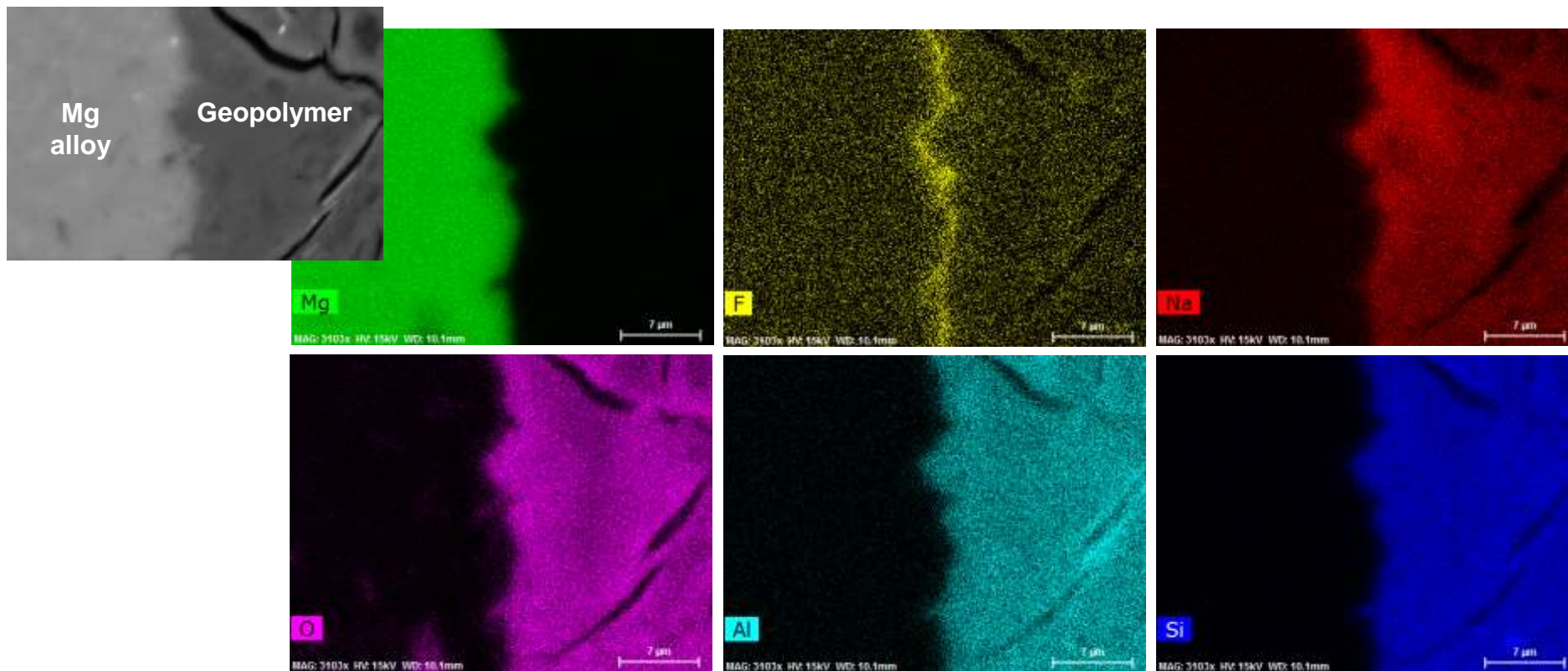

F-rich layer evidenced at the Mg alloy / Na-Geopolymer interface

- MgF_2 or NaMgF_3 layer

Corrosion Potential (E_{corr})

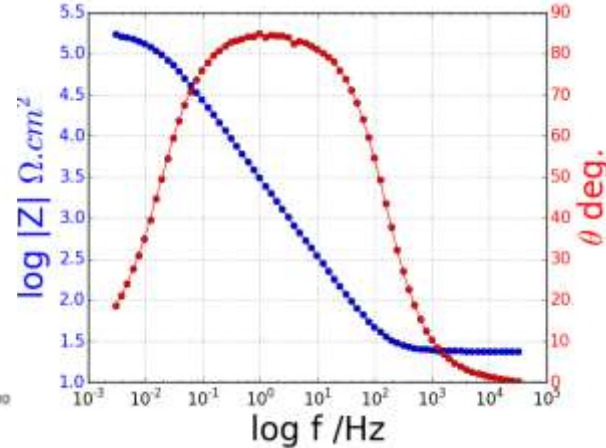
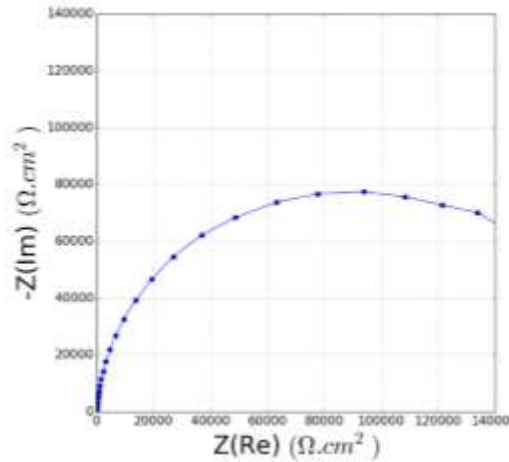
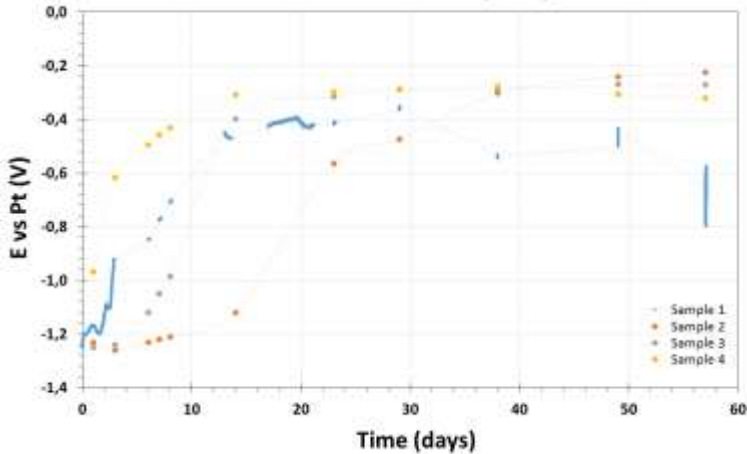

Corrosion potential monitoring:

- Increase to anodic potentials, similar trend to SPS
- No instabilities

Electrochemical Impedance Spectroscopy:

- 1 capacitive loops
- Fitting with Simad software (developped at LISE laboratory, UPMC Paris)

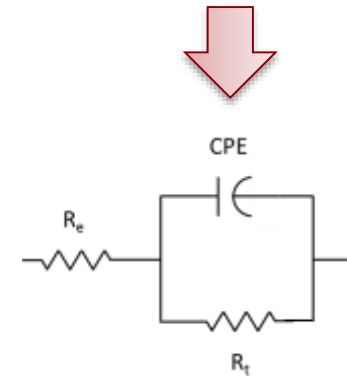

Equivalent circuit
for MgZr / Na-Geo
corrosion modelling

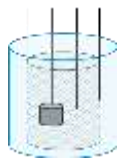

Corrosion Potential (E_{corr})

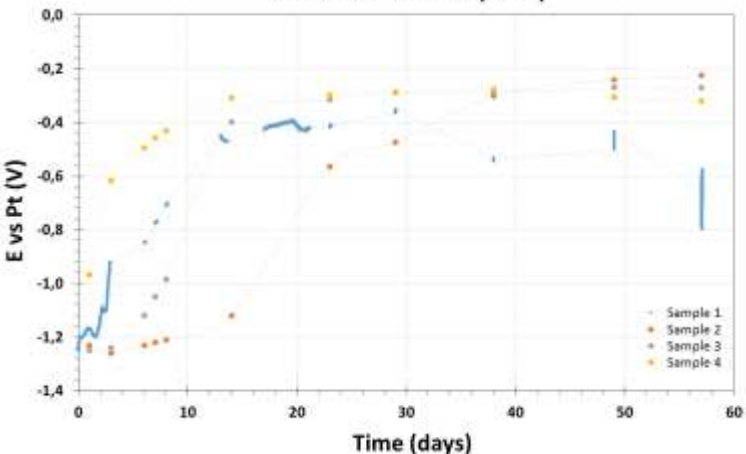

Corrosion potential monitoring:

- Increase to anodic potentials, similar trend to SPS
- No instabilities

Charge transfer resistance (R_t)

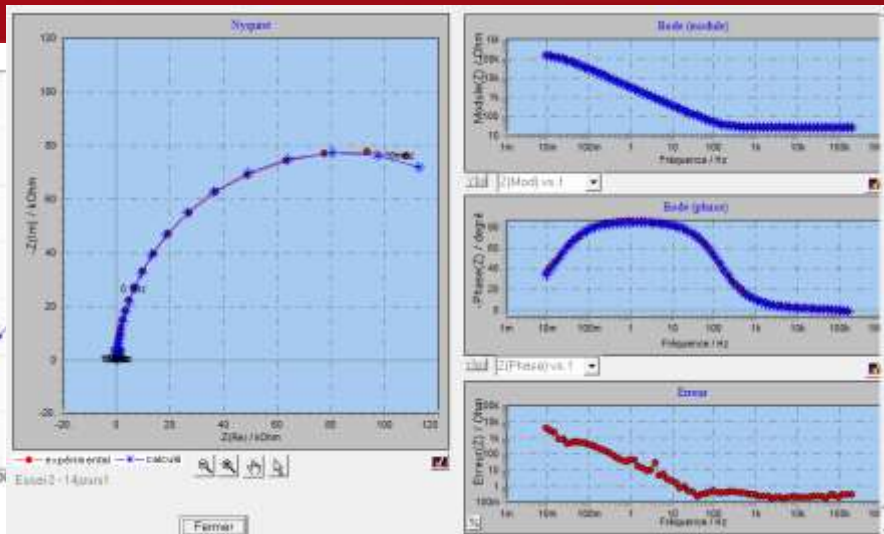
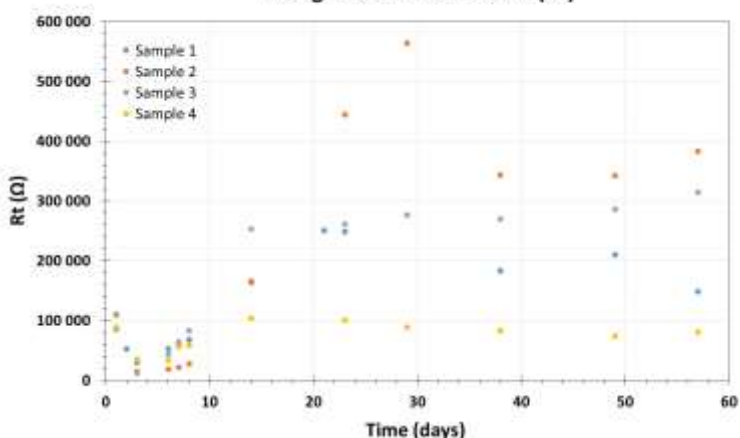

Electrochemical Impedance Spectroscopy:

- 1 capacitive loops
- Fitting with Simad software (developed at LISE laboratory, UPMC Paris)

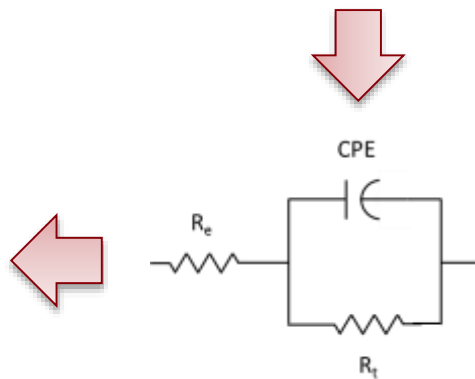

Equivalent circuit
for MgZr / Na-Geo
corrosion modelling

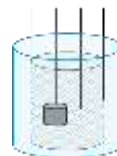

Correlation between geopolymer evolution and Charge transfer resistance

Charge transfer resistance (Rt)

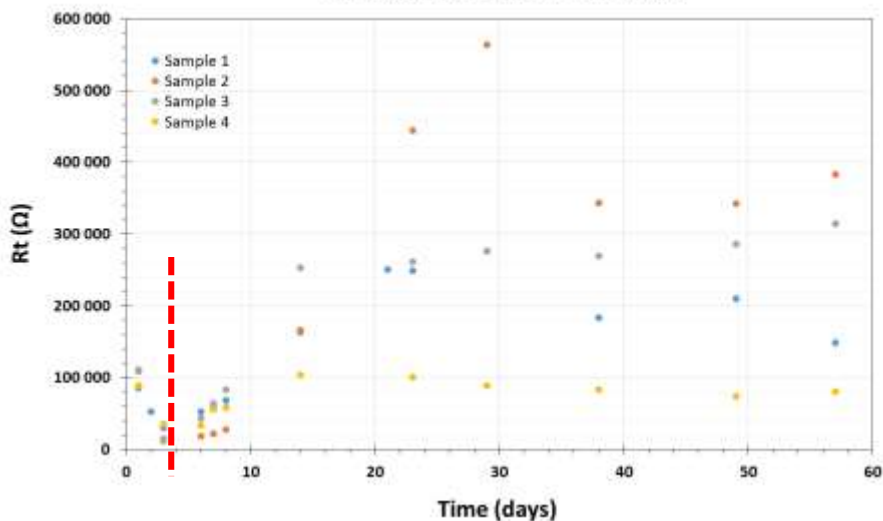

Na-Geopolymer conductivity

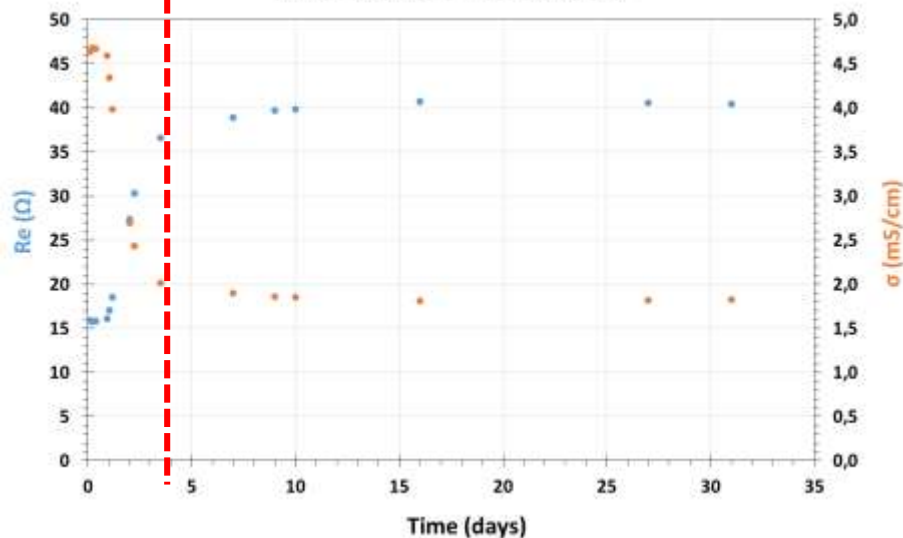

- Rapid evolution of the geopolymer conductivity within the first days and stabilisation at about 1.8 mS cm⁻¹
- Shift of conductivity between day 1 and day 3
- Correlation between geopolymer structuration and local minimum of Rt values

Conclusions

- ❖ Homogeneous surface film composition
 - Probably MgF_2 or NaMgF_3
 - ➔ Further characterisations of the film are still required (Raman, XRD, XPS...)
- ❖ Equivalent circuit with a single R//CPE contribution consistent with the film morphology
- ❖ Local minimum in R_t values at ≈ 3 days corresponding to the geopolymer structuration
- ❖ Order of magnitude for corrosion rate $\approx 0.1 \mu\text{m}/\text{year}$
- ❖ Several experiments are required for repeatability / statistics

Galvanic coupling with steel or graphite

- ✓ Simulate the interaction between Mg wastes and the steel container or Aquadag
- ✓ Electrochemical method: Zero Resistance Ammeter (ZRA)
- ✓ Anode / Cathode surface ratio = 1/1

ZRA - MgZr / S235RJ steel

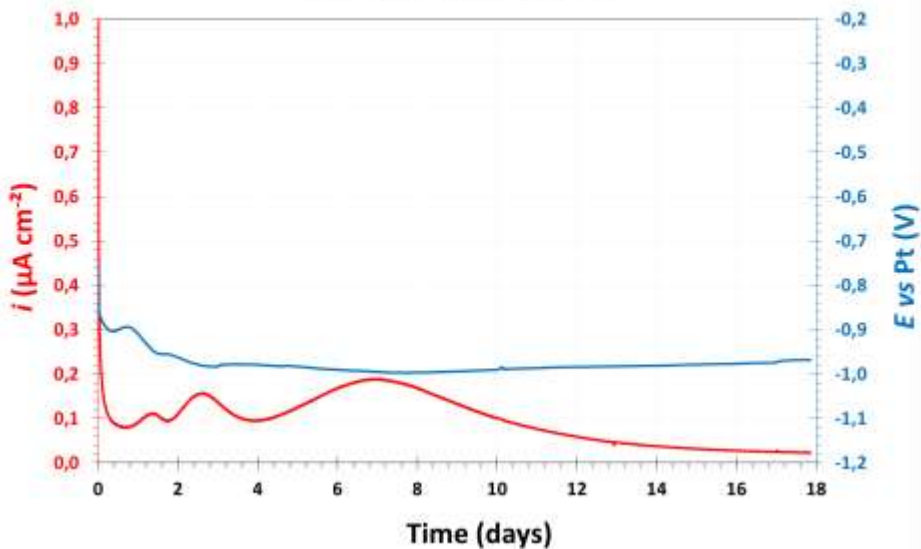

ZRA - MgZr / Graphite

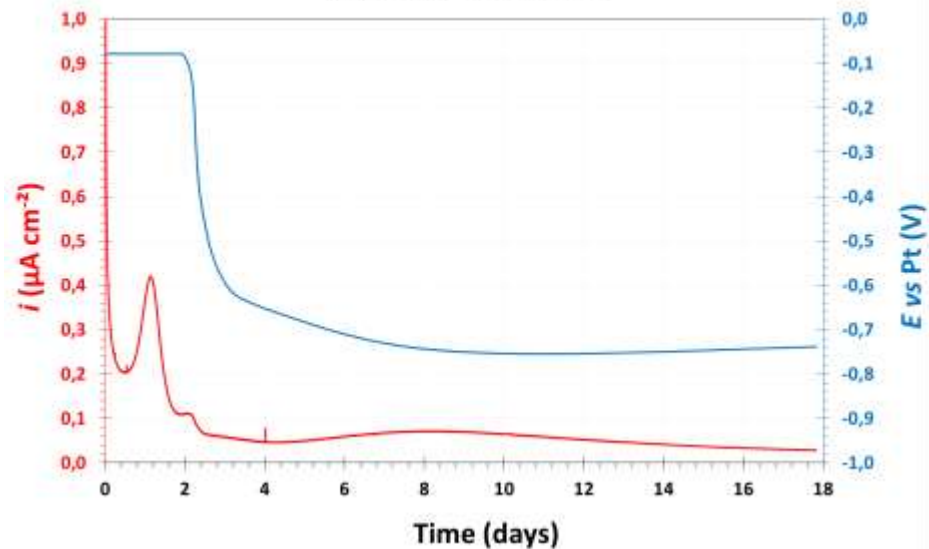

- Stabilisation of the system within a few days in both cases
- Galvanic current densities are about 20-30 nA cm^{-2} after 18 days

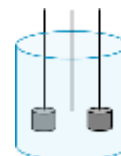

Corrosion rate for general corrosion in Na-geopolymer mortar:

- From EIS (instantaneous rate):

$$i_{\text{corr}} = \frac{1}{n_a \alpha_a + n_c \alpha_c} \frac{RT}{F} \frac{1}{R_t}$$

- From Weight loss measurements: (average rate)

$$v_{\text{corr}} = \frac{\Delta m / S}{\rho_{\text{Mg}} \cdot t}$$

Corrosion rate for galvanic corrosion:

$$v_{\text{corr}} = \frac{i_{\text{corr}} M_{\text{Mg}}}{nF \rho_{\text{Mg}}}$$

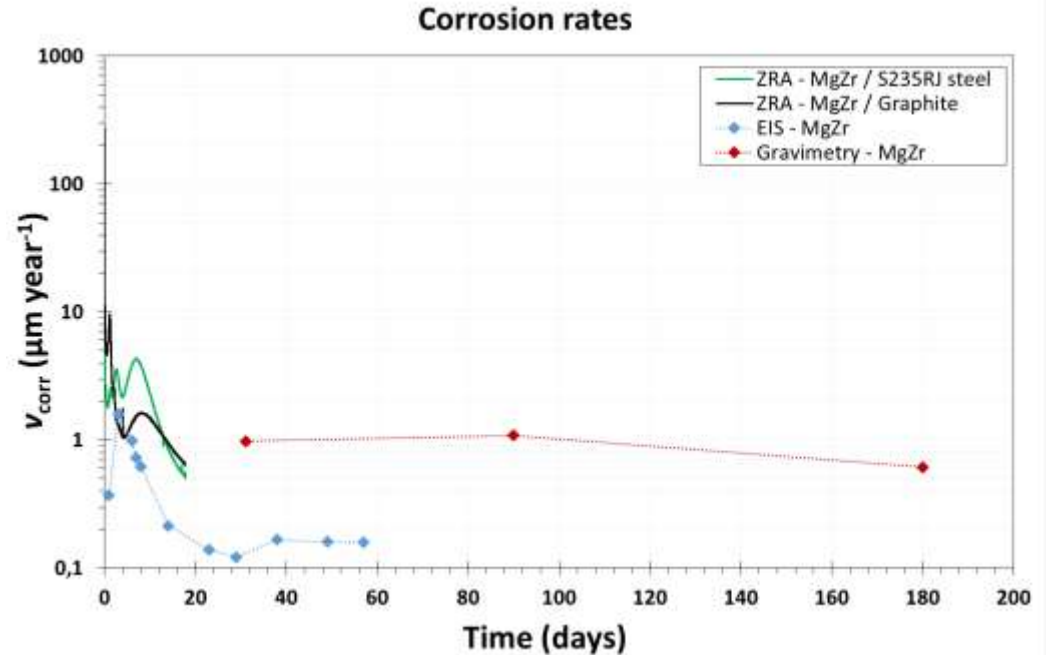

Corrosion rates of MgZr in NaGeo mortar:

- Low corrosion rates: 0.1 - 1 μm year⁻¹
- Small increase due to galvanic coupling (A/C = 1/1)
- H₂ evolution = 0.016 - 0.16 mL cm⁻² year⁻¹

- ❑ Introduction

- ❑ Experimental methodology

- ❑ Corrosion of Mg-alloy in Synthetic Pore Solution
 - *General corrosion*

- ❑ Corrosion of Mg-alloy in Na-Geopolymer Mortar
 - *General corrosion*
 - *Galvanic corrosion*
 - *Conductivity measurements*

- ❑ Conclusions

**Synthetic Na-geopolymer/NaF
pore solution**

Multiple surface film composition:
Mg(OH)₂ ; Na, F, Si rich layer ?
2 capacitive loops for equivalent circuit

Na-geopolymer/NaF mortar

Surface film composition:
F-rich layer: MgF₂ or NaMgF₃ ?
1 single capacitive loop for equivalent circuit

Surface film

General corrosion

Charge transfer resistances (i.e. corrosion rates) of same order of magnitude

Higher rates obtained by weight loss measurements

Galvanic corrosion

Anode / Cathode ratio 1:1
Galvanic corrosion rates ≥ General corrosion rates



Thank you for your attention !

Commissariat à l'énergie atomique et aux énergies alternatives
Centre de Saclay | 91191 Gif-sur-Yvette Cedex
T. +33 (0)1 69 08 20 64 | F. +33 (0)1 69 08 15 86
Secrétariat du LECA francoise.roux@cea.fr

DEN
DPC
SCCME
LECA