



HAL
open science

A reduced micromorphic single crystal plasticity model to study localization and void growth in ductile metals

C. Ling, S. Forest, J. Besson, B. Tanguy, F. Latourte

► To cite this version:

C. Ling, S. Forest, J. Besson, B. Tanguy, F. Latourte. A reduced micromorphic single crystal plasticity model to study localization and void growth in ductile metals. 16th Edition of the European Mechanics of Materials conference, Mar 2018, Nantes, France. cea-02339062

HAL Id: cea-02339062

<https://cea.hal.science/cea-02339062>

Submitted on 13 Dec 2019

HAL is a multi-disciplinary open access archive for the deposit and dissemination of scientific research documents, whether they are published or not. The documents may come from teaching and research institutions in France or abroad, or from public or private research centers.

L'archive ouverte pluridisciplinaire **HAL**, est destinée au dépôt et à la diffusion de documents scientifiques de niveau recherche, publiés ou non, émanant des établissements d'enseignement et de recherche français ou étrangers, des laboratoires publics ou privés.

DE LA RECHERCHE A L'INDUSTRIE

cea den

A reduced micromorphic single crystal plasticity model to study localization and void growth in ductile metals

Chao Ling^{1,2}, Samuel Forest², Jacques Besson², Benoit
Tanguy¹, Félix Latourte³

¹Department of Materials for Nuclear Applications, CEA,
France

²Centre des Matériaux, Mines Paristech, France

³EDF R&D les Renardières, France

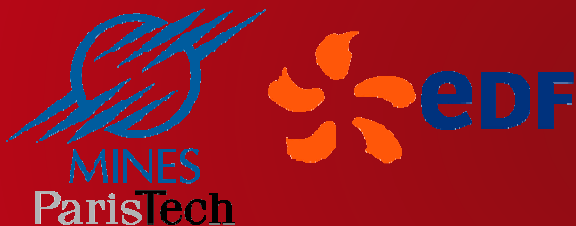

16th Edition of the European Mechanics of Material conference, Nantes,
France, March 26-28 2018

- ✓ Background: ductile fracture of irradiated stainless steels
- ✓ Void growth and coalescence study at micro-scale (conventional crystal plasticity)
- ✓ Enhanced crystal plasticity model to describe size effect
- ✓ Results on Void growth and coalescence study at micro-scale
- ✓ Conclusions and perspectives

PWR's internals structures made of austenitic stainless steel (300 series)

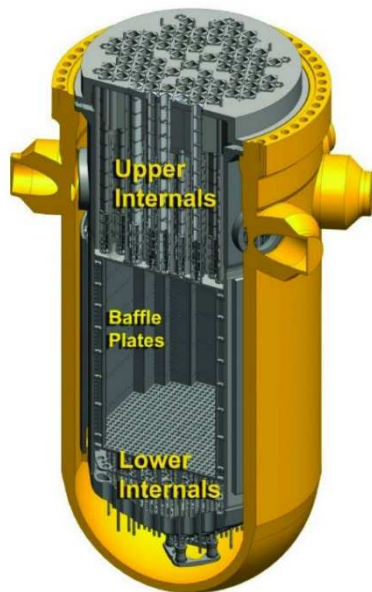

Fracture toughness

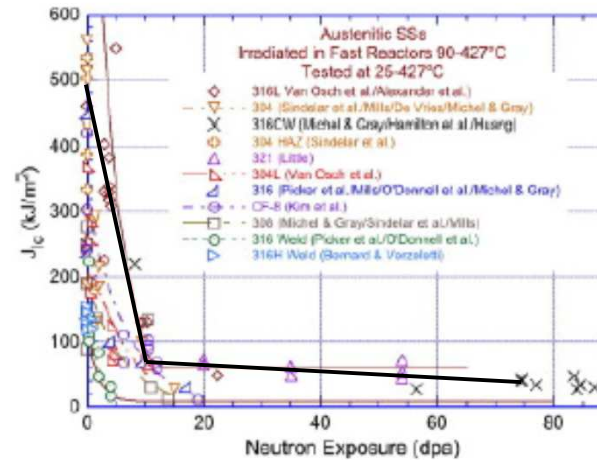

[Chopra & Rao (2011)]

Strong decrease of fracture toughness with irradiation related (How?) to evolution of mechanical properties (due to irradiation defects).

Physical mechanisms ?

[Das and Tarafder (2009)]

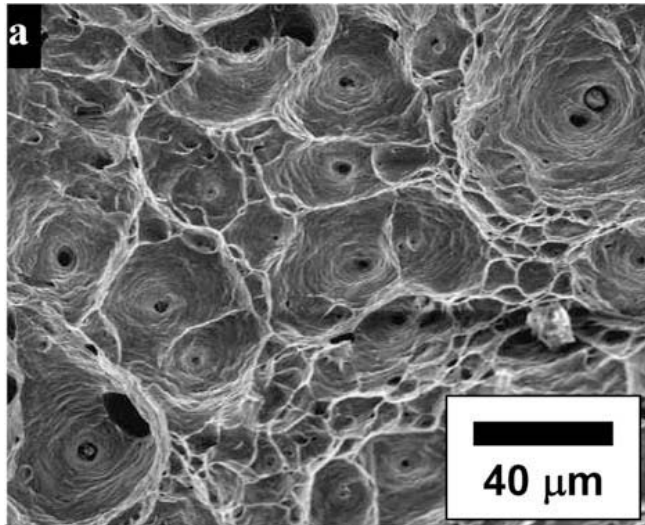

Dimples on fracture surface

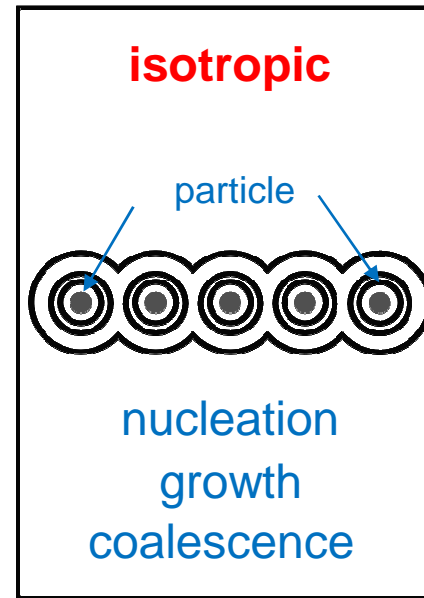

Mechanism

[Pineau and Pardoën (2007),
Besson (2010),
Benzerga and Leblond (2010)]Pioneering modeling:

McClintock (1968), Rice and Tracey (1969)

Gurson (1977):

$$\frac{\sigma_{eq}^2}{\sigma_0^2} + 2f \cosh\left(\frac{3}{2} \frac{\sigma_m}{\sigma_0}\right) - 1 - f^2 = 0$$

Its extensions accounting for nucleation, coalescence, void shape, etc

Voids growth and coalescence at microscale on irradiated materials

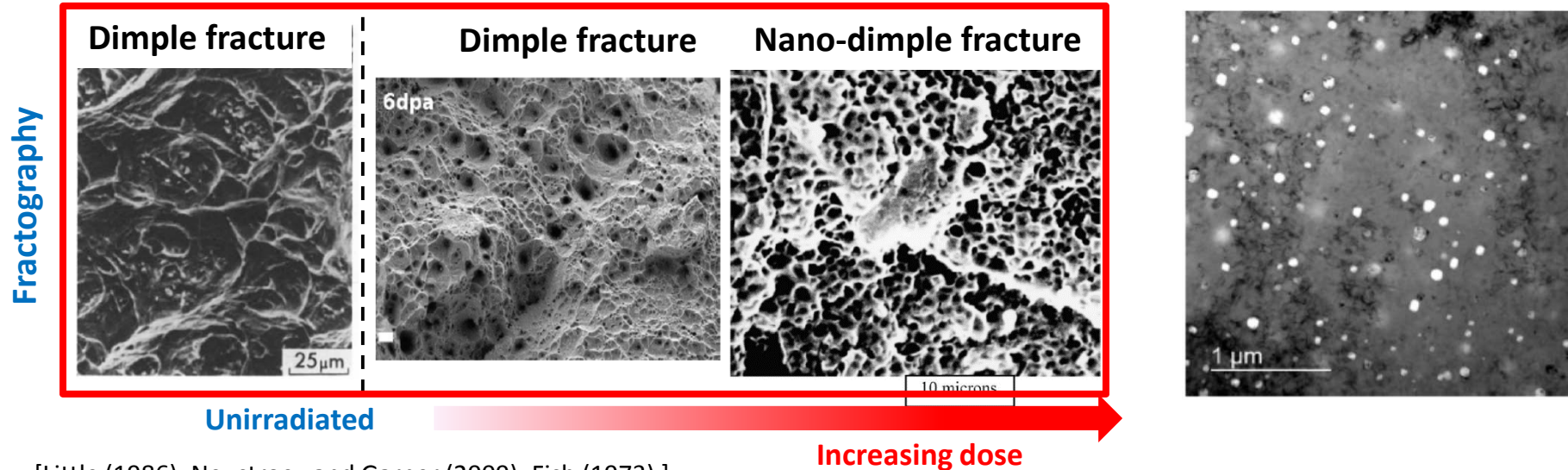

[Little (1986), Neustroev and Garner (2009), Fish (1973)]

Dimple-type Transgranular Fracture

Some characteristics of the ductile fracture

- ❑ Intragranular voids
- ❑ Decreasing dimple size with irradiation
- ❑ Potential nano-dimple fracture at high irradiation levels



- ✓ Grain-scale modeling
- ✓ Nano-voids → size effects ?
- ✓ Experimental study : see Barrioz and al. (Monday, room KL, 11H30)
- ✓ Homogenized model : see Scherer and Hure (Wednesday, Audit 450,15h)

Polycrystal
with
intragranular
voids

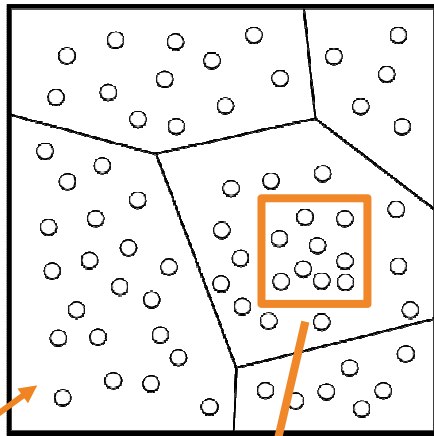

hardening

Voided
single crystal

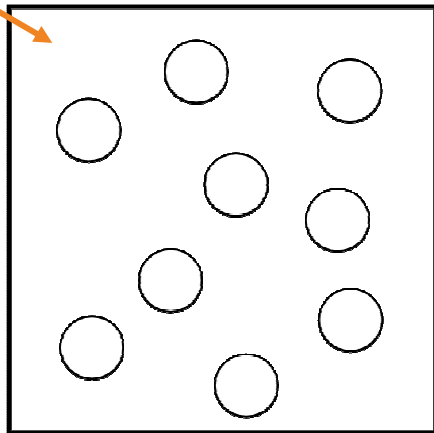

➤ Crystal plasticity at finite strains

□ FCC crystal

- ✓ Plasticity: dislocation motion
- ✓ Slip planes $\{111\}$
- ✓ Slip directions $\langle \bar{1}10 \rangle$
- ✓ 12 slip systems
- ✓ Schmid tensor $\underline{N}^s = \underline{m}^s \otimes \underline{n}^s$

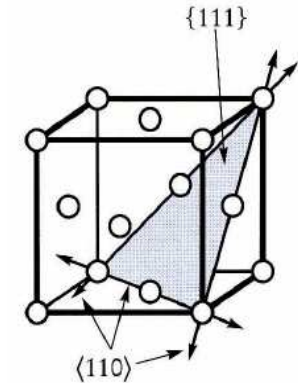

□ Schmid's law:

Plastic slip is initiated when the resolved shear stress τ^s on a slip plane reaches a critical value τ_c^s

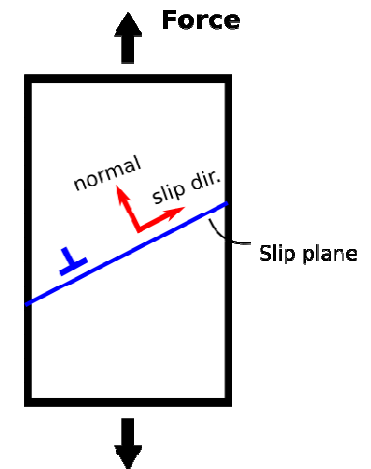

✓ **Kinematics:**

Deformation gradient: $\tilde{\mathbf{F}} = \tilde{\mathbf{E}} \cdot \tilde{\mathbf{P}}$

✓ **Flow rule:**

Yield function: $\phi^s = \tau^{*s} - \tau_c^s \geq 0$

$$\tau^{*s} = |\tau^s| = |\tilde{\mathbf{M}} : \tilde{\mathbf{N}}^s| \quad \tilde{\mathbf{M}} = J_e \tilde{\mathbf{E}}^T \cdot \boldsymbol{\sigma} \cdot \tilde{\mathbf{E}}^{-T}$$

Plastic strain rate: $\dot{\tilde{\mathbf{P}}} \cdot \tilde{\mathbf{P}}^{-1} = \sum_{s=1}^{12} \dot{\gamma}^s \frac{\partial \phi^s}{\partial \tilde{\mathbf{M}}} = \sum_{s=1}^{12} \dot{\gamma}^s \text{sign}(\tau^s) \tilde{\mathbf{N}}^s$

Plastic slip rate: $\dot{\gamma}^s = \dot{\gamma}_{\text{ref}} \left\langle \frac{\phi^s}{\tau_{\text{ref}}} \right\rangle^n$

✓ **Hardening rule**

$$\tau_c^s = \tau_T^s + \mu b_D \sqrt{\sum_{u=1}^{12} a^{su} \rho_D^u} \quad [\text{Kubin (2008)}]$$

✓ **Dislocation density**

$$\dot{\rho}_D^s = \frac{1}{b_D} \left(\frac{1}{L^s} - g_c \rho_D^s \right) \dot{\gamma}^s \quad \text{with} \quad L^s = \kappa \left(\sum_{u=1}^{12} b^{su} \rho_D^u \right)^{-1/2}$$

Multiplication Annihilation

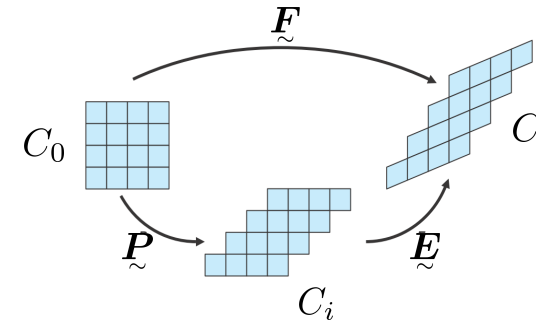

Study of growth and coalescence at microscale → FE Unit cell simulations: problem setup

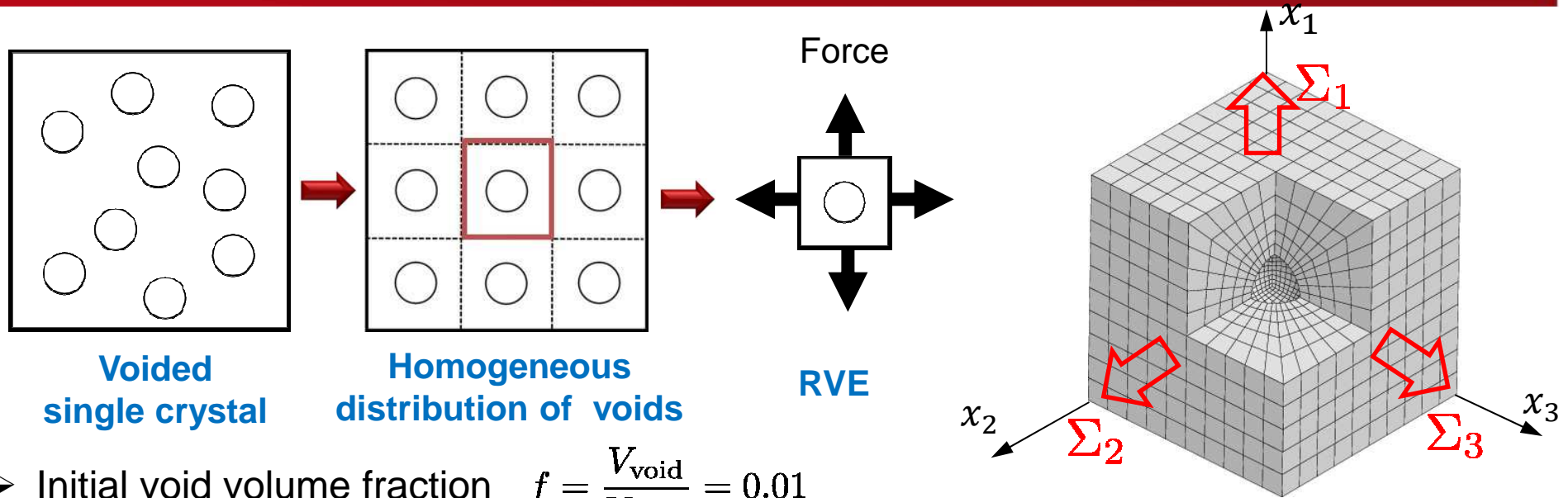

- Initial void volume fraction $f = \frac{V_{\text{void}}}{V_{\text{total}}} = 0.01$
- Periodic boundary conditions
- Axisymmetric loading $\Sigma_2 = \Sigma_3$
- Constant stress triaxiality $T = \frac{\Sigma_m}{\Sigma_{eq}} = 1 - 3$
- Different crystal orientations

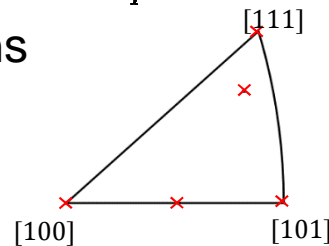

- $x_1 - x_2 - x_3$
- [100]-[010]-[001]
 - [110]-[1̄10]-[001]
 - [111]-[2̄11]-[01̄1]
 - [210]-[1̄120]-[001]
 - [1̄125]-[12̄1]-[210]

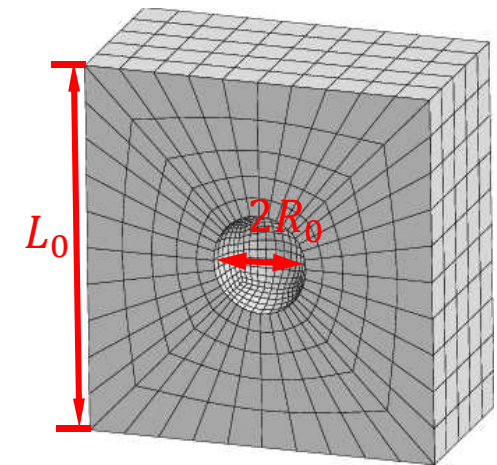

Study of growth and coalescence at microscale → Effect of crystal orientation

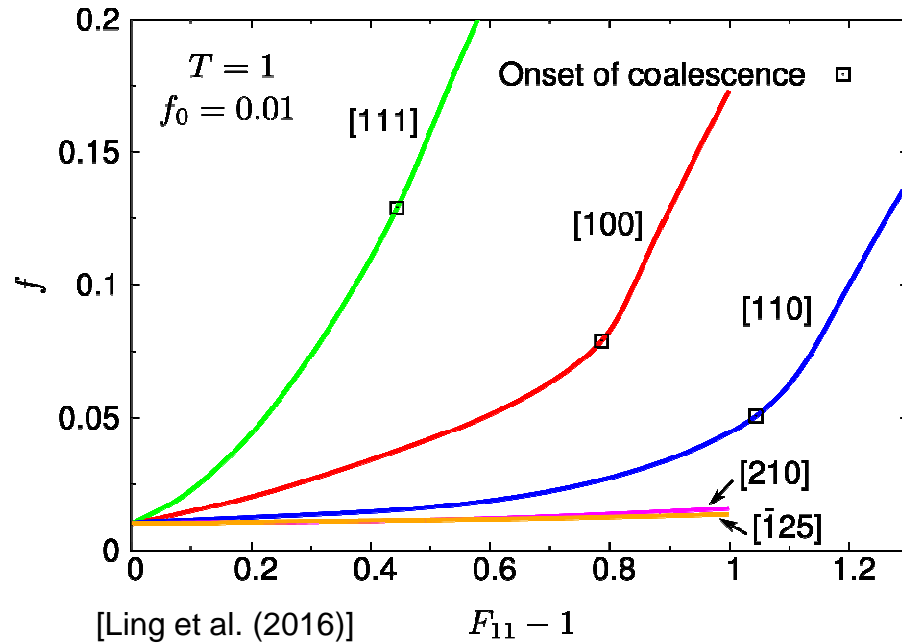

[100] $T = 1.0$

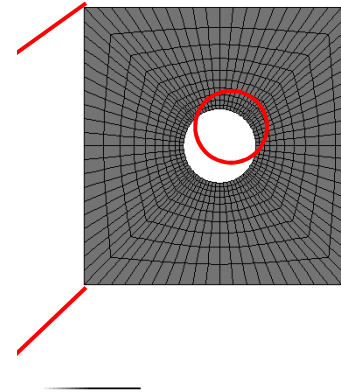

$[\bar{1}25]$ $T = 1.0$

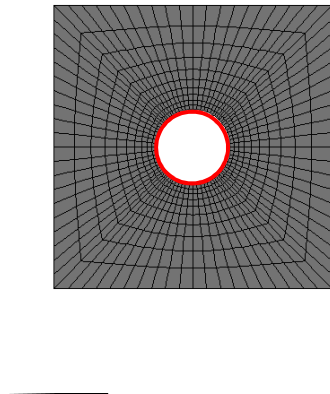

- ✓ Effect of crystal orientation on the evolution of void shape
- ✓ Two stages: **growth** and **coalescence**
- ✓ Significant effect of the crystal orientation on void growth rate at $T=1$

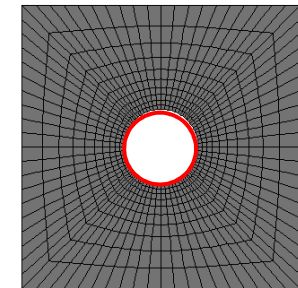
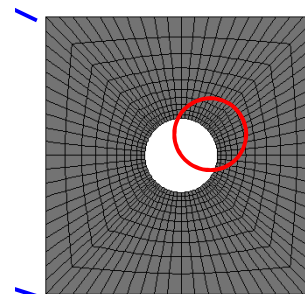

Study of growth and coalescence at microscale → Effect of crystal orientation at different triaxialities

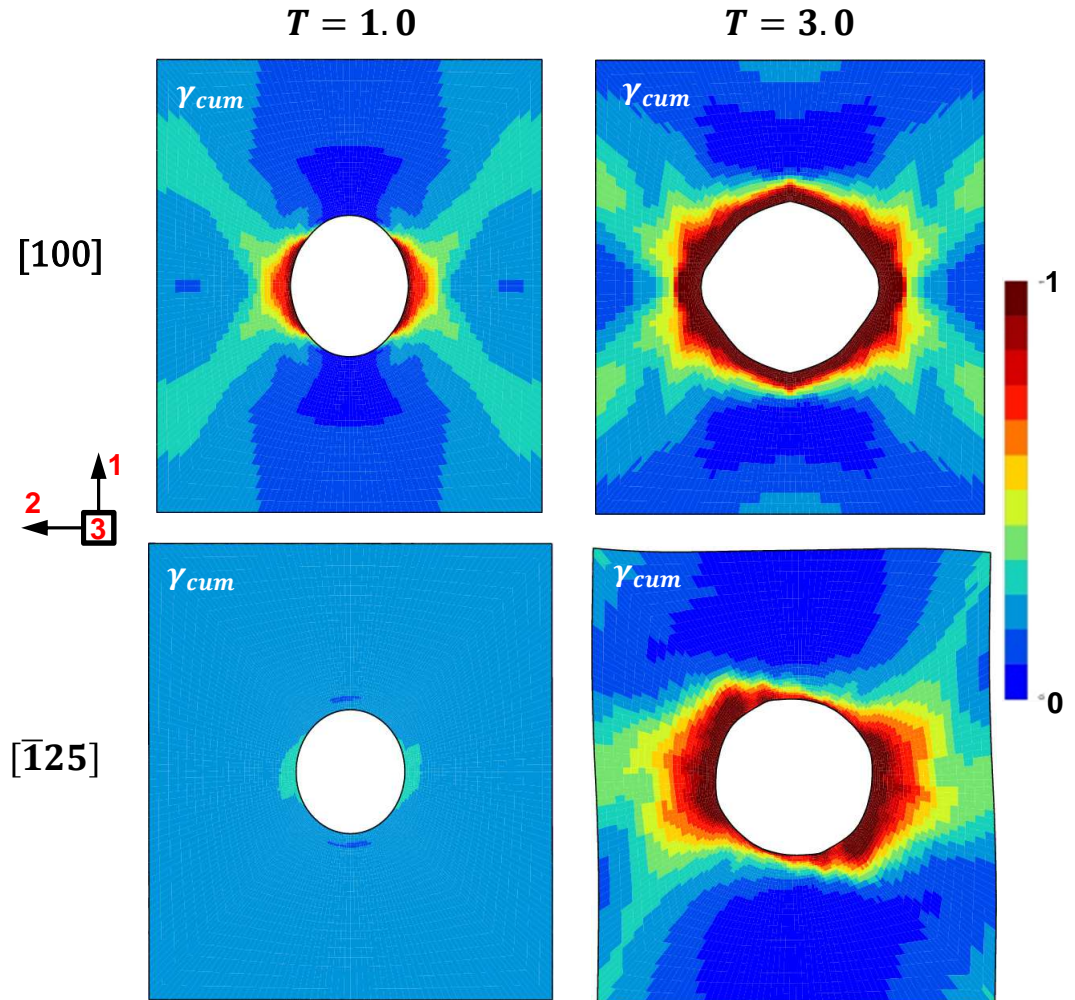
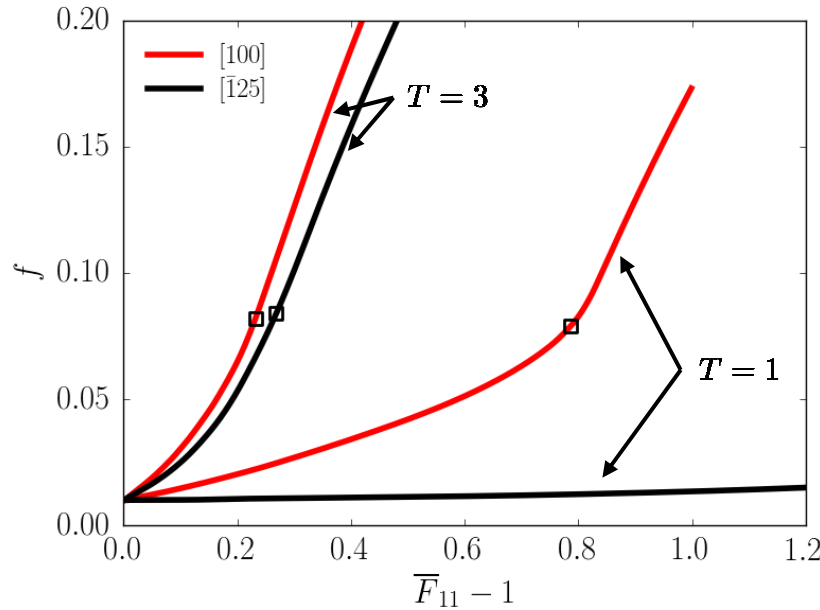

- ✓ Stronger effect of crystal orientation at $T=3$
- ✓ In agreement with Yerra et al. (2010) for BCC
- ✓ Why?

[Ling et al. (2016)]

$$\gamma_{cum} = \sum_s \gamma^s$$

$$F_{11} - 1 = 0.1$$

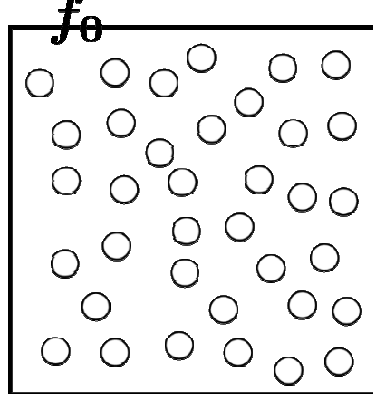
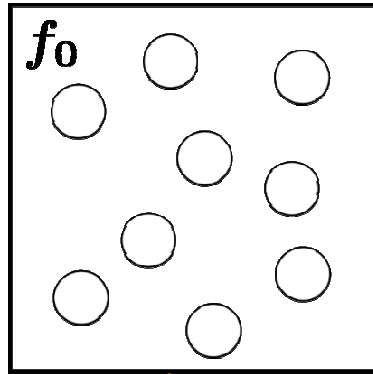

Decreasing size of voids

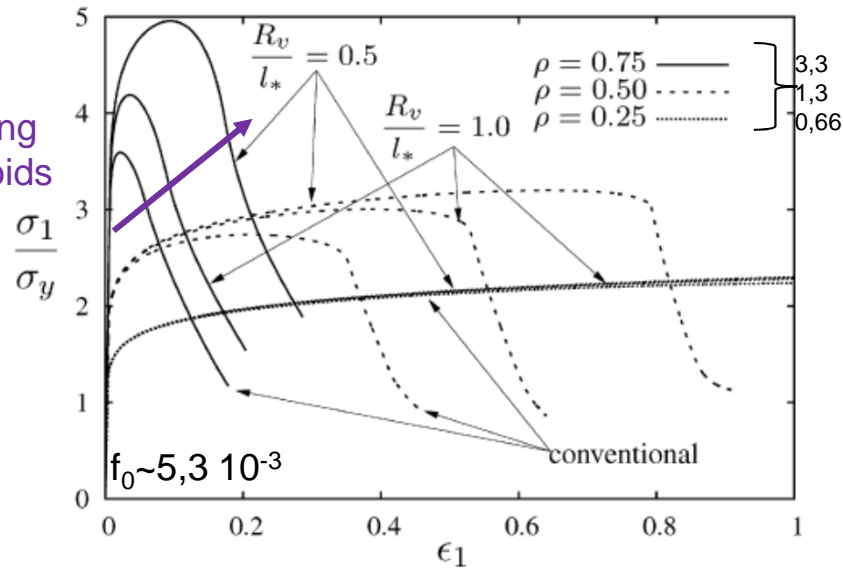

Loading ratio

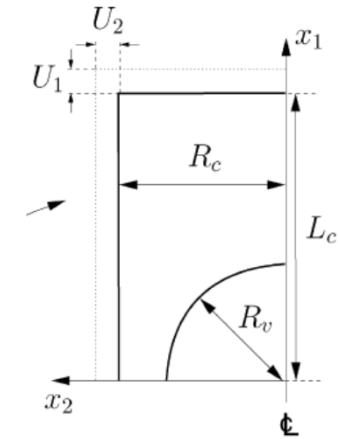

l_* : fixed length material parameter

C.F Niordson, Eur. J. Mech A/Solids2008

Size effect:

- Modify the attainable stress level
- Depend on stress ratio and initial volume fraction
- Modify the growth and coalescence
- Smaller is stronger !

✓ Need to enhance the crystal plasticity model

Study of growth and coalescence at microscale → Enhanced crystal plasticity models in the literature

Gradient terms	Additional DOFs in FEM	Number of the additional DOFs	Examples of references
$\nabla \gamma^s$	γ^s	12 DOFs (FCC)	(Gurtin, 2002) (Gurtin et al., 2007) (Borg, 2007)
$\nabla \nabla u$	∇u	9 DOFs	(Shu et Fleck, 1999)
$\text{Curl } P_\chi$	P_χ	9 DOFs	(Cordero et al., 2010) (Aslan et al., 2011) (Cordero et al., 2012)
$\nabla \gamma_\chi$	γ_χ	1 DOF	(Wulfinghoff et Böhlke, 2012) (Wulfinghoff et Böhlke, 2013)

Our constraints:

- Implementation in Finite Element code in finite strain
- Application to fracture toughness modelling -> simulation of small structures (specimens)
- Future derivation of an elastoviscoplastic model for porous single crystals at finite strains including strain gradient effects



Aifantis-type model: numerically efficient

Aifantis, IJP, 1987

γ_χ : microslip variable

✓ **Kinematics**

Deformation gradient: $\underline{\underline{F}} = \underline{\underline{E}} \cdot \underline{\underline{P}}$

✓ **Power of internal forces** [Eringen, 1969; Germain, 1973]

$$P^i = \int_D \underline{\underline{\sigma}} : \text{grad } \underline{\underline{u}} \quad dV \quad \longrightarrow$$

One additional balance equation + boundary condition

✓ **Flow rule**

γ_{χ} is akin to: $\gamma_{cum} = \sum_{s=1}^{12} \gamma^s$

Yield function: $\phi^s = \tau^{*s} - (\tau_c^s) = \tau^{*s} - (\tau_c^s) \geq 0$

$$\begin{aligned} \text{div } \underline{\underline{\sigma}} &= 0 \\ \text{div } \underline{\underline{m}} - s &= 0, \\ &\forall \underline{\underline{x}} \in D, \end{aligned}$$

Generalized stress: $S = Js = H_{\chi}(\gamma_{\chi} - \gamma_{cum})$

$$\tau^{*s} = |\tau^s| = |\underline{\underline{M}} : \underline{\underline{N}}^s| \quad \underline{\underline{M}} = J_e \underline{\underline{E}}^T \cdot \underline{\underline{\sigma}} \cdot \underline{\underline{E}}^{-T} \quad \text{Relative plastic slip}$$

Plastic strain rate: $\dot{\underline{\underline{P}}} \cdot \underline{\underline{P}}^{-1} = \sum_{s=1}^{12} \dot{\gamma}^s \frac{\partial \phi^s}{\partial \underline{\underline{M}}} = \sum_{s=1}^{12} \dot{\gamma}^s \text{sign}(\tau^s) \underline{\underline{N}}^s$

$\underline{\underline{N}}^s = \underline{\underline{m}}^s \otimes \underline{\underline{n}}^s$,
the Schmid tensor

Plastic slip rate: $\dot{\gamma}^s = \dot{\gamma}_{ref} \left\langle \frac{\phi^s}{\tau_{ref}} \right\rangle^n$

Study of growth and coalescence at microscale → Unit cell simulations with micromorphic model

$$U_X(X=0) = 0, U_X(X=L_0) = U_1(t),$$

$$U_Y(Y=0) = 0, U_Y(Y=L_0) = U_2(t),$$

$$U_Z(Z=0) = 0, U_Z(Z=w_0) = 0.$$

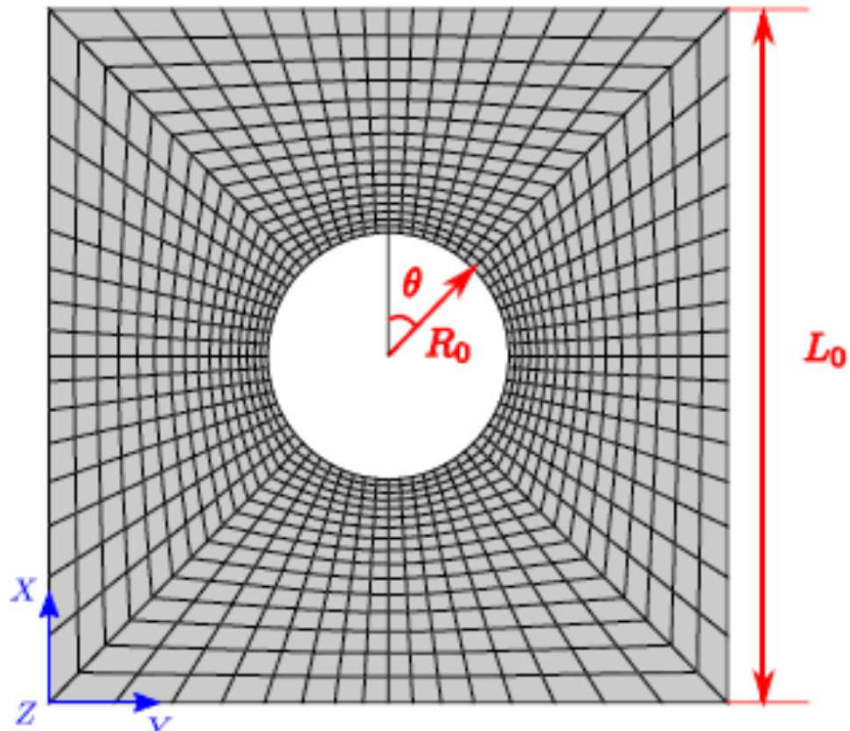

Cylindrical void in a plate

biaxial tensile loading in plane strain,
 $\sigma_{22}/\sigma_{11}=0,625$

FCC single crystal

$$U_X(X=0) = 0, U_X(X=L_0) = U_1(t),$$

$$U_Y(Y=0) = 0, U_Y(Y=L_0) = U_2(t),$$

$$U_Z(Z=0) = 0, U_Z(Z=L_0) = U_3(t) = U_2(t).$$

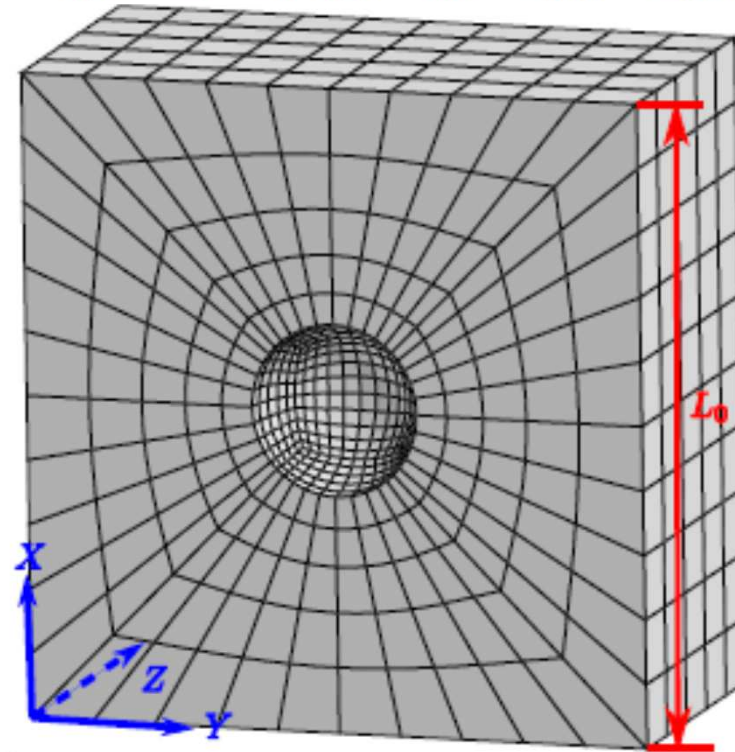

Spherical void in a cube

Stress triaxiality $T = \frac{\bar{\sigma}_m}{\bar{\sigma}_{eq}} = 2$

Crystal orientation : [100]-[010]-[001] $f_0=0.01$
 $H\chi=5 \cdot 10^4$ Mpa, $A=5$ N, L_0 variable

$$\lambda_c = \sqrt{\frac{A(H\chi + H)}{H\chi H}} = 0,06\text{mm}$$

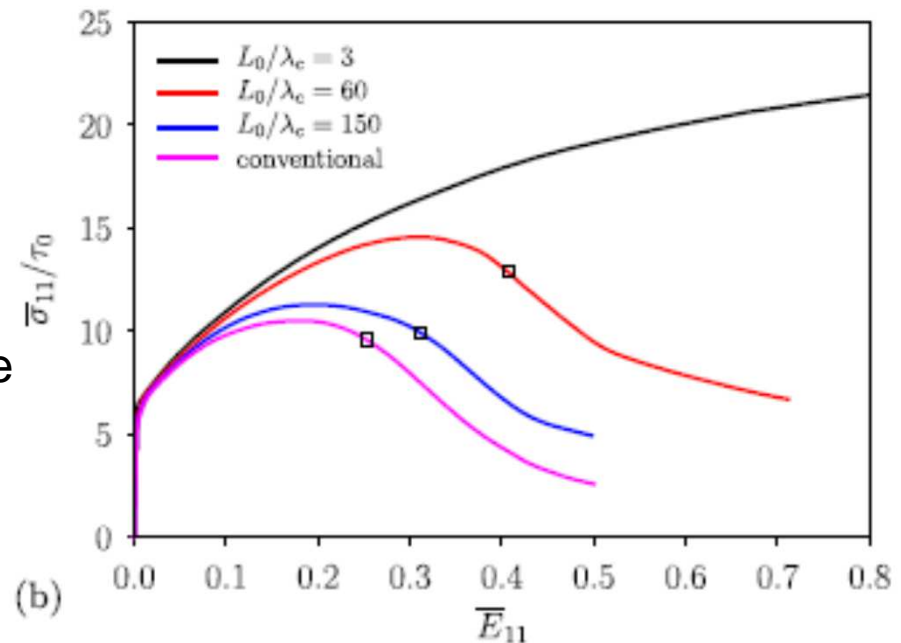
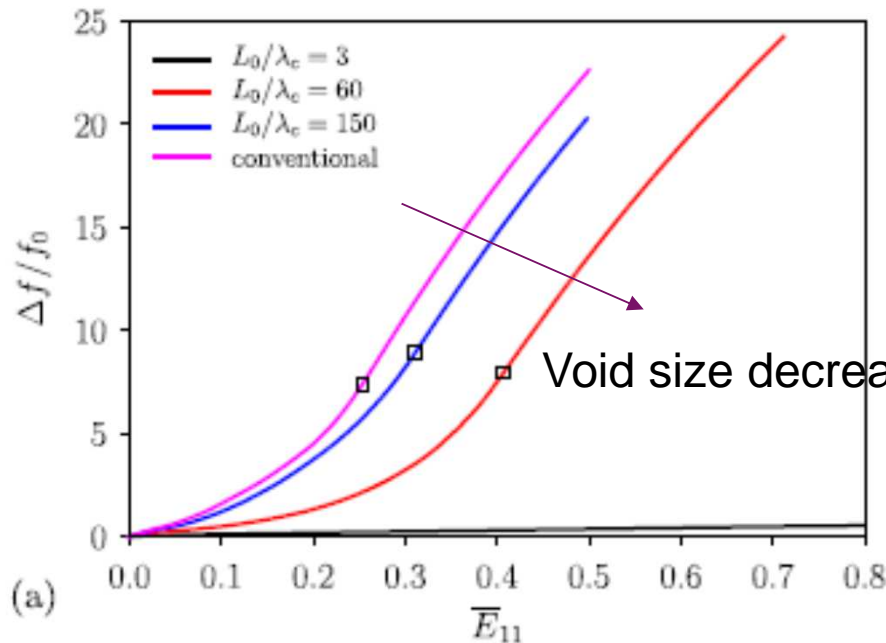

- Void growth rate decreases with decreasing normalized unit cell size L_0/λ_c
- Overall stress : competition between hardening and softening due to void growth
- Decreasing L_0/λ_c : higher stress level due to strain gradient hardening and reduction of growth rate

[100]-[010]-[001] [100]-[01-1]-[011] $f_0=0.1$

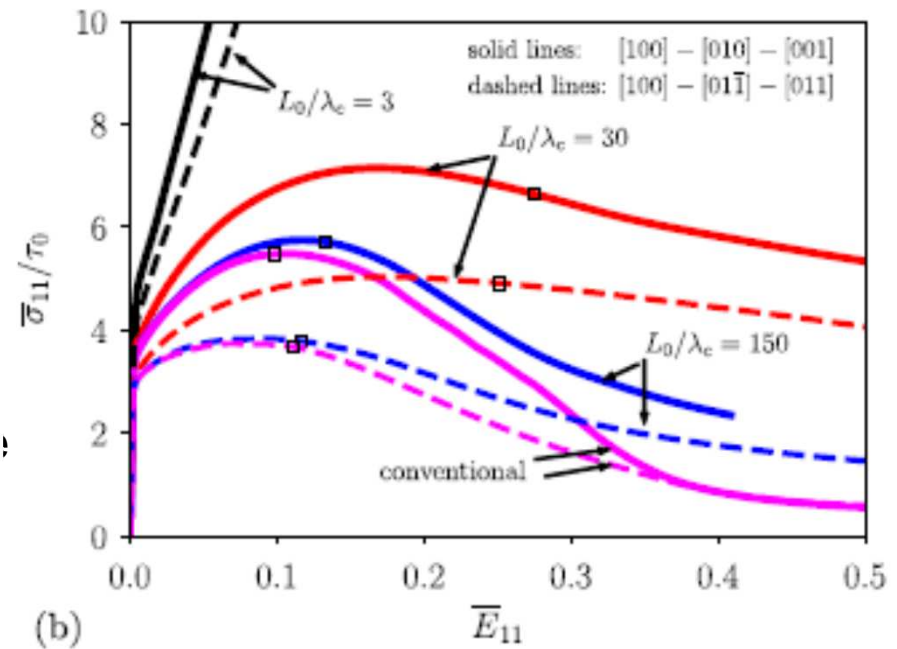
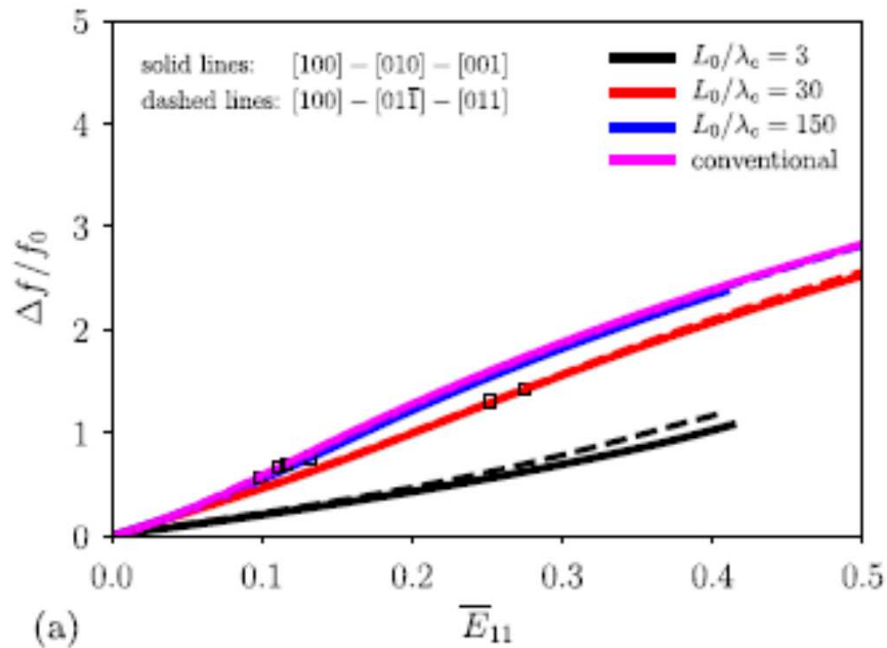

- For a given L_0/λ_c : Similar void growth rate but different stress-strain responses
- Related to the difference of active slip systems in the matrix
- Higher stress level for [100]-[010]-[001]
- Transition from growth to coalescence less marked than for $f_0=0,01$
- Void growth rate can not be neglected for $L_0/\lambda_c=3$

[100]-[010]-[001]

$f_0=0.01$

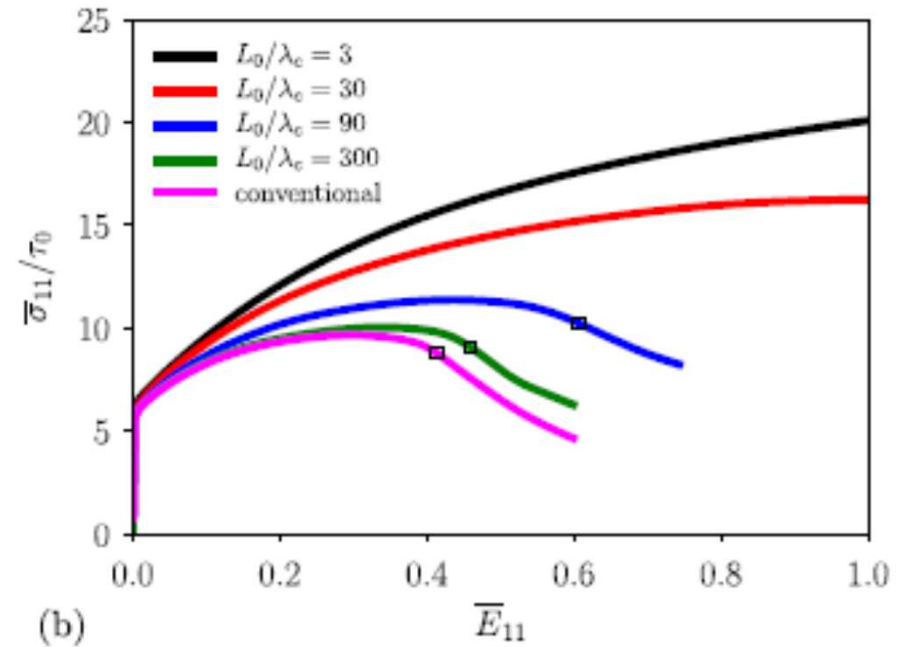
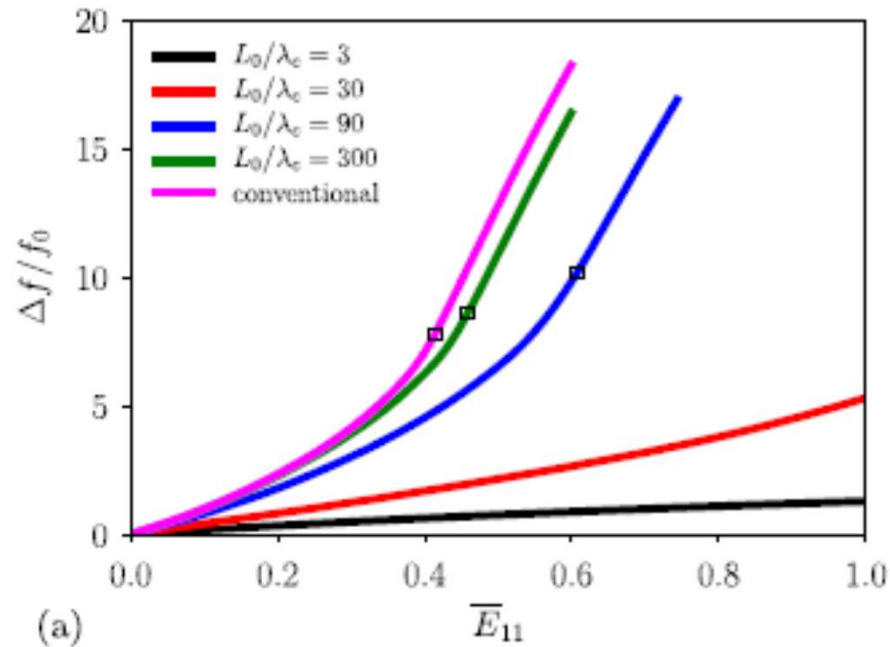

- Similar trends than for cylindrical void
- Softening occurs for larger strain for spherical void

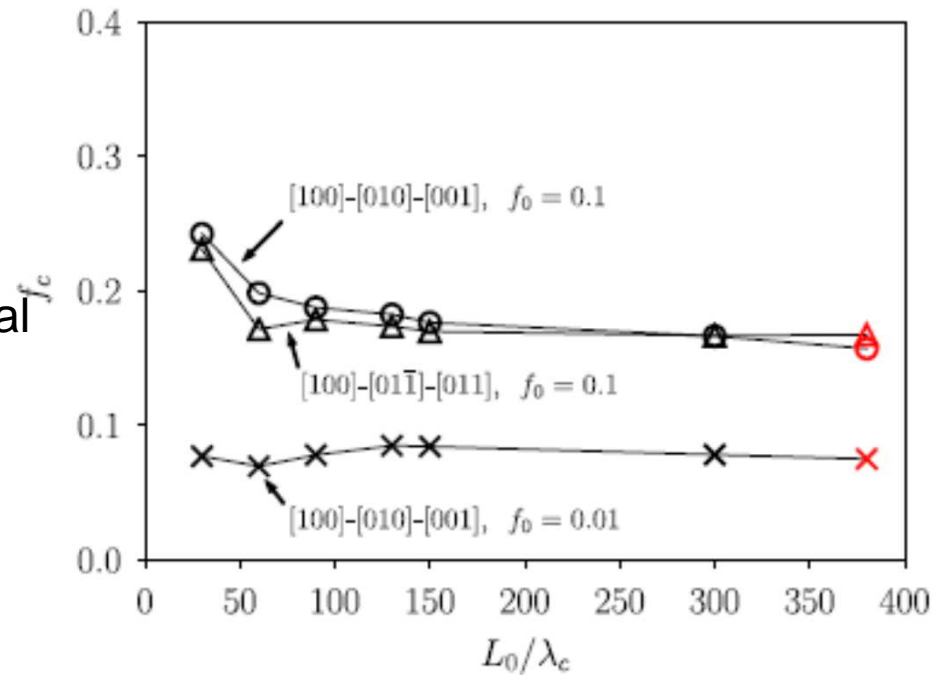
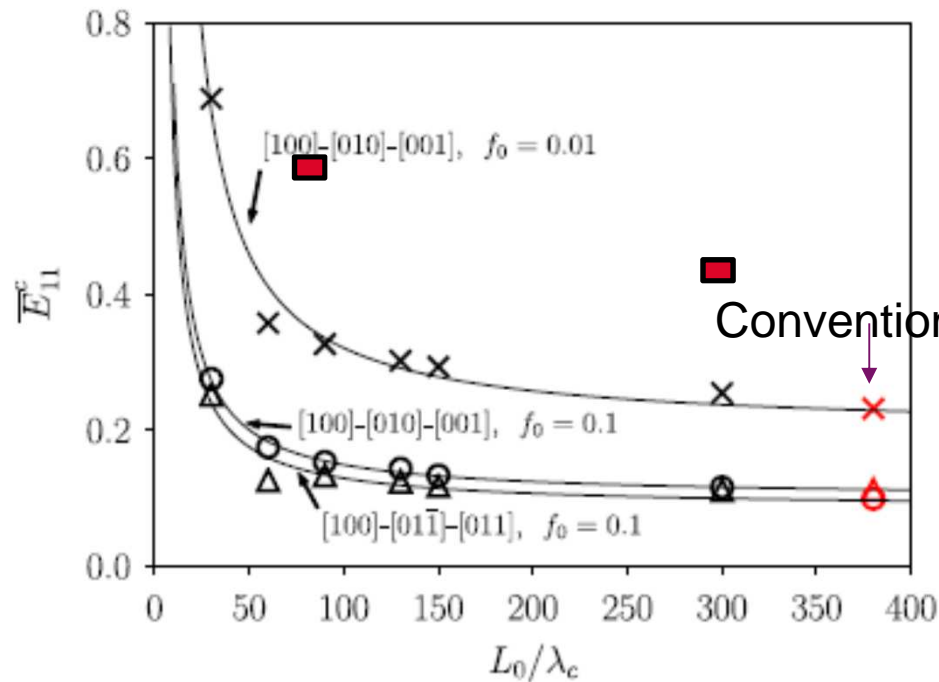

- Onset of coalescence is delayed with decreasing L_0/λ_c
- Size effect can be neglected on f_c for $f_0=0,01$
- Increase in f_c when $L_0/\lambda_c < 60$ for $f_0=0,1$
- Critical strain at coalescence significantly larger for spherical void (■)

$E_{11}=0,1, f=0,1$ [100]-[010]-[001]

$$\gamma_{cum} = \sum_s \gamma^s$$

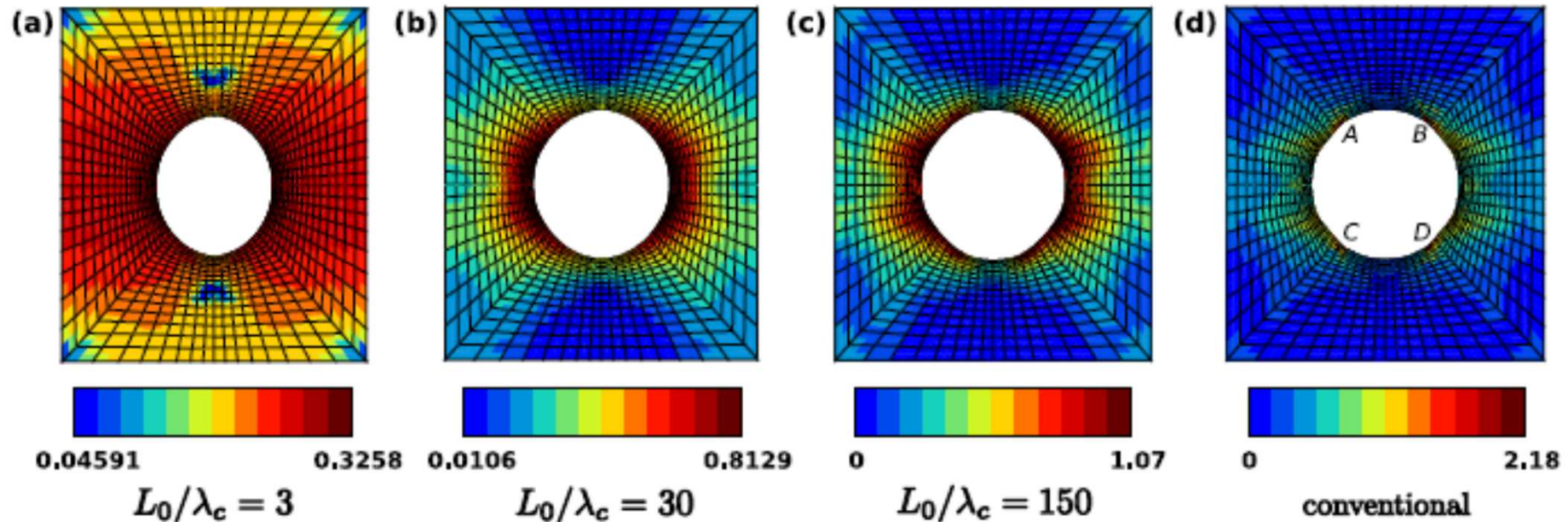

- 4 zones of plastic localization for the conventional theory
- Plastic deformation fields become more diffuse when L_0/λ_c decreases
- Maximum γ_{cum} lower based on micromorphic theory -> void growth is slowed down

$E_{11}=0,4$, $f=0,1$ [100]-[010]-[001]

$$\gamma_{cum} = \sum_s \gamma^s$$

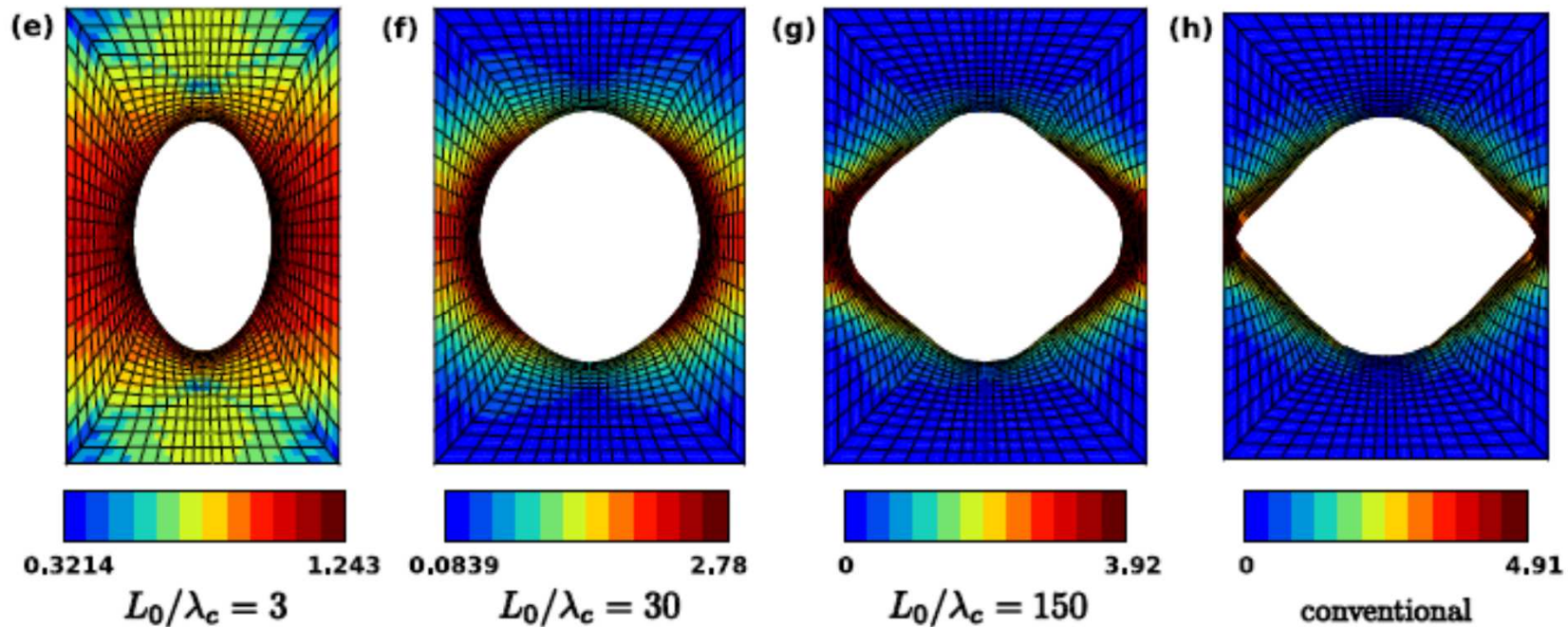

- Plastic deformation fields become more diffuse when L_0/λ_c decreases
- Maximum γ_{cum} lower based on micromorphic theory -> [Effect on the void shape](#)

$E_{11}=0,3, f=0,1$ [100]-[010]-[001]

$$\gamma_{cum} = \sum_s \gamma^s$$

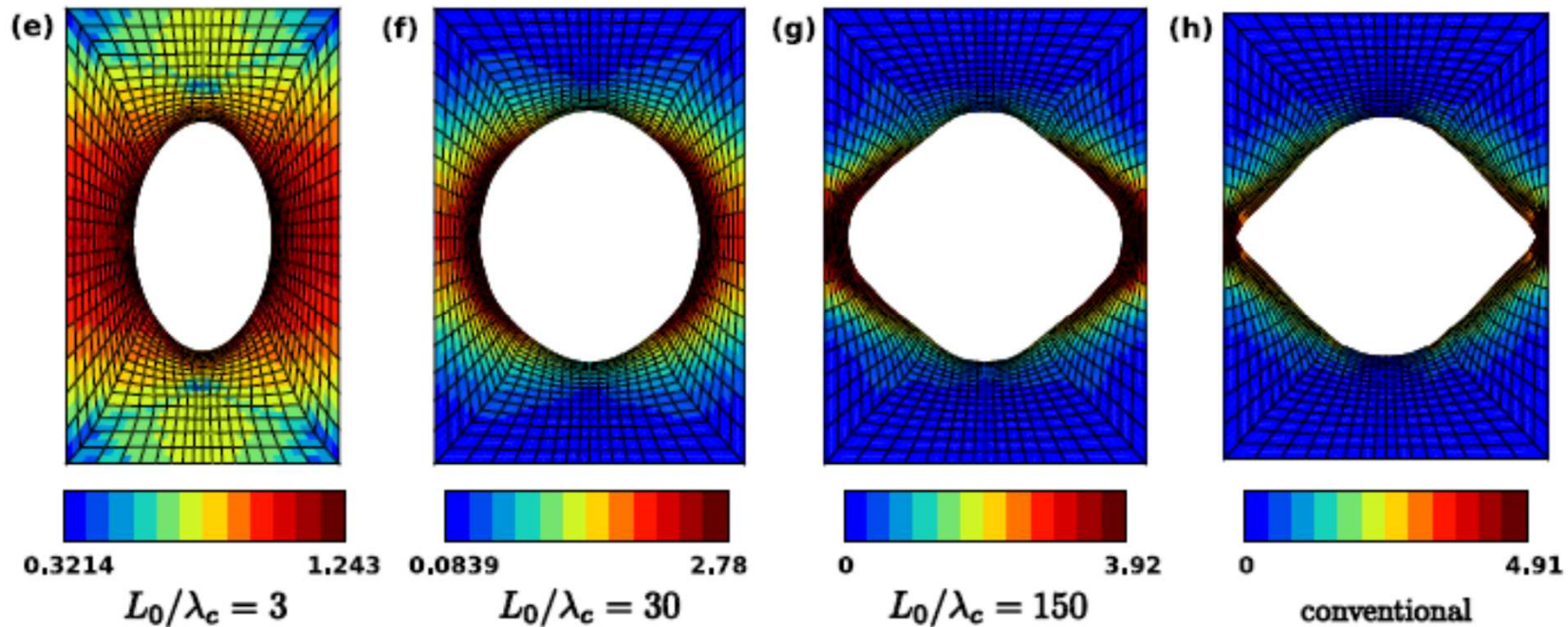

- Plastic deformation fields become more diffuse when L_0/λ_c decreases
- Maximum γ_{cum} lower based on micromorphic theory -> [Effect on the void shape](#)

$E_{11}=0,3$, $f=0,01$ [100]-[01-1]-[011]

$$\gamma_{cum} = \sum \gamma^s$$

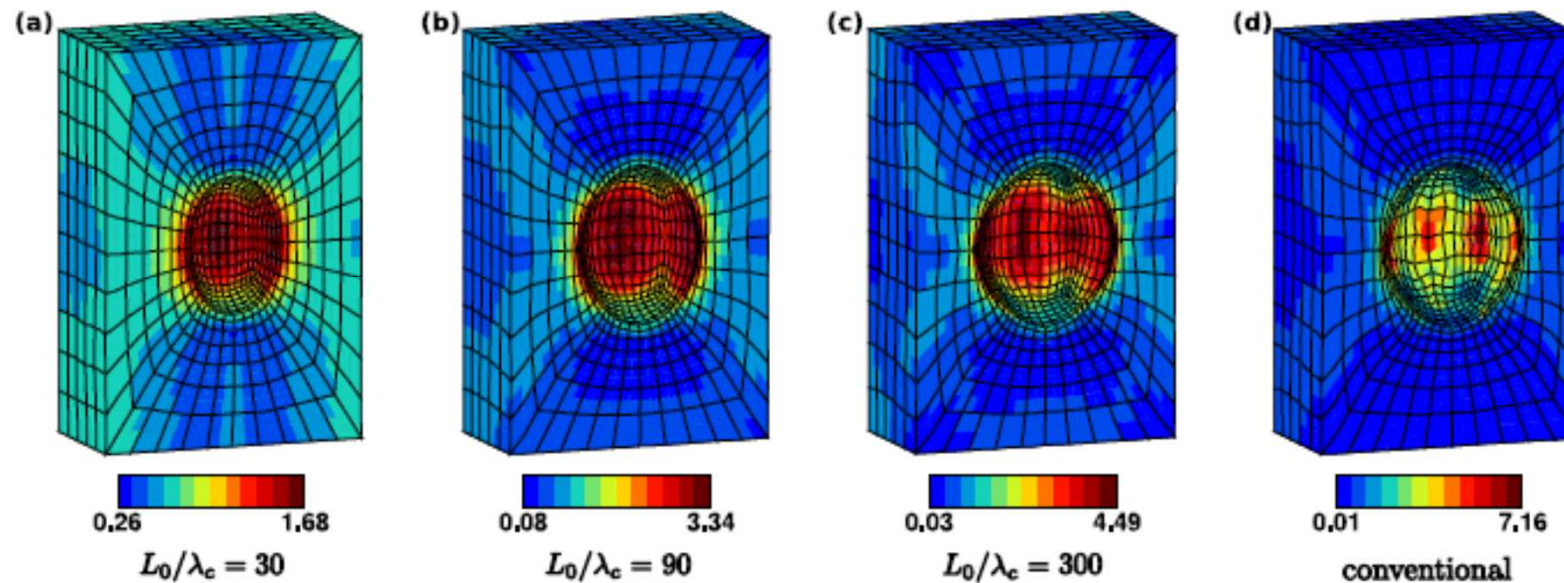

- Plastic deformation fields become more diffuse when L_0/λ_c decreases
- Maximum γ_{cum} lower based on micromorphic theory
- Localisation of the plastic slip localization zones very different from the cylindrical case

- ❑ Void growth rate depends on crystal orientation and the effect is more significant at lower stress triaxialities.
 - ✓ This justifies the proposed approach for modeling ductile fracture at the scale of grain
- ❑ A micromorphic single crystal plasticity model has been proposed and implemented
- ❑ Size dependant overall behavior and void growth by the micromorphic model for voided single crystal
- ❑ Unit cells of smaller size exhibit a lower void growth rate compared with larger ones -> higher hardening rate and delayed onset of coalescence
- ❑ Future work: Modelling of the nanovoids growth (see Barrioz and al. for experimental work)
- ❑ The model will be coupled with the porous single crystal model of Ling et al. (2016)

Thank you for your attention!



benoit.tanguy@cea.fr

Commissariat à l'énergie atomique et aux énergies alternatives
Centre de Saclay | 91191 Gif-sur-Yvette Cedex
T. +33 (0)1 69 08 17 25 | F. +33 (0)1 69 08 93 24

Direction DEN
Department of Materials for Nuclear
Applications

Etablissement public à caractère industriel et commercial | RCS Paris B 775 685 019