



**HAL**  
open science

## Recent advances in digital coincidence counting for Radionuclide Metrology

J. Keightley, Christophe Bobin, Jacques Bouchard, M. Capogni, S. Loreti, M.  
Roteta

► **To cite this version:**

J. Keightley, Christophe Bobin, Jacques Bouchard, M. Capogni, S. Loreti, et al.. Recent advances in digital coincidence counting for Radionuclide Metrology. 2013 3rd International Conference on Advancements in Nuclear Instrumentation, Measurement Methods and their Applications (ANIMMA), Jun 2013, Marseille, France. pp.06728057, 10.1109/ANIMMA.2013.6728057 . cea-01822344

**HAL Id: cea-01822344**

**<https://cea.hal.science/cea-01822344v1>**

Submitted on 2 Aug 2023

**HAL** is a multi-disciplinary open access archive for the deposit and dissemination of scientific research documents, whether they are published or not. The documents may come from teaching and research institutions in France or abroad, or from public or private research centers.

L'archive ouverte pluridisciplinaire **HAL**, est destinée au dépôt et à la diffusion de documents scientifiques de niveau recherche, publiés ou non, émanant des établissements d'enseignement et de recherche français ou étrangers, des laboratoires publics ou privés.

# Recent Advances in Digital Coincidence Counting for Radionuclide Metrology

John Keightley, Christophe Bobin, Jacques Bouchard,  
Marco Capogni, Stefano Loreti, Miguel Roteta

**Abstract**— The radioactivity measurement techniques developed within the EURAMET EMRP “MetroFission” Joint Research Project, were aimed at performing on-site activity measurements at the primary standard level ( $4\pi\beta\text{-}\gamma$  coincidence counting) for a wide range of radionuclides utilizing recent advances in high-speed digital sampling and digital signal processing. The state-of-the-art technology employed within this project provides up to 14-bit digitizer systems operating with sampling rates in the order of  $10^8$  to  $10^9$  samples-per-second, incorporating on-board FPGA devices, which greatly enhances the application of digital signal processing for the implementation of digital coincidence counting. These devices when coupled to suitable analysis software, demonstrate a significant improvement in the provision of primary standards of radioactivity. This manuscript provides a description of the systems employed, along with recommendations regarding optimization of the digital sampling of signals from photomultiplier tubes and pre-amplifiers and compare the benefits of “off-line” versus “on-line”  $4\pi\beta\text{-}\gamma$  digital coincidence counting systems.

**Index Terms**—  $4\pi\beta\text{-}\gamma$  coincidence counting, digital coincidence counting, digital signal processing, radionuclide metrology, list-mode acquisition.

## I. INTRODUCTION

CLASSICAL instrumentation dedicated to the primary standardization of radioisotopes by the  $4\pi\beta\text{-}\gamma$  Coincidence Counting method [1], [2] at National Metrology Institutes (NMIs) is typically composed of several discrete electronic modules designed to implement specific functionalities (trigger generation, dead-time imposition, pulse-height analysis, imposition of delays, forming

(Manuscript submitted for review, May 2013)

This research has received funding from the European Union on the basis of Decision No 912/2009/EC, and forms part of the European Metrology Research Programme (EMRP) “MetroFission” project (<http://projects.npl.co.uk/metrofission/>)

John Keightley is with the National Physical Laboratory (NPL), Hampton Road, Teddington, Middlesex, TW11 0LW, United Kingdom (e-mail: john.keightley@npl.co.uk).

Christophe Bobin and Jacques Bouchard are with the CEA, LIST, Laboratoire National Henri Becquerel (LNE-LNHB), 91191 Gif-sur-Yvette Cedex, France (e-mail: christophe.bobin@cea.fr and jack.bouchard@cea.fr)

Marco Capogni and Stefano Loreti are with the The National Institute of Ionizing Radiation Metrology (ENEA-INMRI), Via Anguillarese, 301 - 00123 S.Maria di Galeria, Roma, Italy (e-mail: marco.capogni@enea.it and stefano.lorete@enea.it)

Miguel Roteta is with the CIEMAT, Avenida Complutense 22, 28040 Madrid, Spain (e-mail: miguel.roteta@ciemat.es)

coincidences/vetoes etc). These modules are arranged in such a manner to take advantage of the time-correlations between registrations of the “coincident” events that stem from a single nuclear disintegration, for example beta-minus decay followed by prompt gamma emission. The detector systems are chosen so that each detector is highly sensitive to one of the emanations and fairly insensitive to the other. Measurement of the single count rates, as well as the rate of “coincident” events then leads to an accurate estimate of the detector efficiencies themselves and an absolute estimate of the source activity which is not reliant on prior calibrations of detector efficiencies. Such measurements are regularly performed by several NMIs, and the results for a particular radionuclide are ratified via international comparison exercises under the auspices of the International Weights and Measures Bureau (BIPM) in Sèvres, Paris. These primary standards of radioactivity form the basis for the measurement traceability chains required to demonstrate that measurements made “in the field” are adequately precise.

Many NMIs are particularly concerned by the problem of maintenance and renewal of their nuclear instrumentation [3] and the current trend in the field is to make use of data acquisition systems based on high-speed digitizers, where the A/D conversion is performed as close as possible to the output of the detector or preamplifier (in contrast to traditional systems where A/D conversion usually appears at the end of the counting chain, following suitable analog processing of the detector signals).

These digital data streams, representative of the detector outputs, may be operated on by dedicated algorithms programmed onto Field Programmable Gate Arrays (FPGAs), such as digital filters, pulse shapers, constant fraction discriminators, timing filters, baseline restorers etc. Such algorithms are used to extract the quantities of interest from the large digitized data streams. In  $4\pi\beta\text{-}\gamma$  coincidence counting the quantities of most interest are the particle energy (proportional to the charge released by the particle in the detector) and the arrival time of the pulse.

These reduced data sets may be analyzed to implement the  $4\pi\beta\text{-}\gamma$  coincidence counting method by either processing the digital streams in “real-time” by employing further dedicated algorithms programmed in FPGA-based devices, or to log the digitized pulse height and timing information in *list-mode* and process the information “off-line” via bespoke software routines.

Each of these approaches has its own merit, with the real-time approach offering a system capable of reporting the estimate of the source activity with little or no intervention from the operator. The list-mode approach offers an improved transparency in the calculations, where not only an estimate of the source activity can be reported, but the entire data set used in the determination estimate may be provided, for verification and validation by another NMI. Other attractive advantages to the analysis of list-mode data sets is that the analysis algorithms may be readily programmed by a metrologist with no expertise in the programming of FPGAs, as well as the obvious freedom to “replay” the data sets through the software routines whilst altering a multitude of counting parameters (dead-times, gamma-gates, delays etc). In both cases, the real advantage of digitization of the pulse trains is that the FPGA algorithms and/or the software analysis routines can be reprogrammed at any time, without the need to purchase additional hardware.

## II. FRONT END ELECTRONICS

The  $4\pi\beta\text{-}\gamma$  coincidence method may employ a variety of detector types. For the detection of beta particles (as well as X-rays/Auger electrons following electron capture decay and internal conversion processes), proportional counters at both atmospheric and elevated pressures are commonly used, as are liquid scintillation detectors and plastic scintillators. For the detection of gamma photons, the use of NaI(Tl) and HPGe detectors are commonplace. Other detector configurations are obviously possible, and there are too many to list here in details. In some detector configurations, (i.e.: where a PMT is employed) the signal strength is often sufficient to enable a direct coupling to the digitizer, without employing a preamplifier. However, careful consideration must be given to the input impedance of the A/D converters employed, and it is often beneficial to employ additional dedicated front-end electronics to optimize the coupling to the A/D converter, in order to acquire an accurate representation of the electrical charge generated by the radiation detectors. For example, coupling the PMT from a high-efficiency NaI(Tl) detector to the CAEN digitizer (described later in this manuscript) yielded better results after employing the additional interface described in the next section. Such considerations are particularly important in order to achieve suitable low-energy thresholds to enable extrapolation to zero energy where required and to minimize degradation of the signal to noise ratio. Due to space limitations, in this manuscript we report our experiences on only a few of the possible detector configurations.

### A. NaI(Tl) Detector with PMT

Although the amplification properties of the PMT enable signals to be directly coupled to a digitizer, an interface was designed to handle the high dynamic range of signals provided by the NaI(Tl) detector and to limit the influence of saturated pulses generated for instance by high-energy gamma photons and particularly by the influence of cosmic rays (Figure 1).

The interface is suitable for general use with NaI(Tl) detectors, and in particular for high-efficiency detectors.

For that purpose, the first stage of the front-end electronics is composed of a high-voltage, wideband operational amplifier (THS4631, Gain=1) designed to accept pulses of high amplitudes ( $\sim 20$  V). The goal is to limit the effect of saturated signals that generally leads to undershoots resulting from an abrupt decrease of the input impedance when a collector-base junction is forward biased. The decay time (ranging between 5 and 10  $\mu$ s) is defined by the RC value at the interface input. The second stage of the interface limits the signal voltage delivered by the first. It is composed of a wide-bandwidth-voltage feedback clamp amplifier (AD8036, Gain=1) in order to limit both positive and negative polarities. This stage was used to set the maximum voltage delivered to the last interface stage. Designed as a Rauch-type filter [4], the last stage (THS 4631, Gain = 10) sets the final gain and it implements an anti-aliasing low-pass filter (Bessel type, 2.2 MHz). This output stage has a  $\pm 10$  V dynamic range (50  $\Omega$ ). The power supply is equal to  $\pm 24$  V. Contrary to usual shaping amplifiers, no significant distortion of pulse shapes has been observed following the occurrence of high-amplitude or saturated signals. Because no lengthy undershoot is observed, the dead-time management can be simplified in the digital pulse processing.

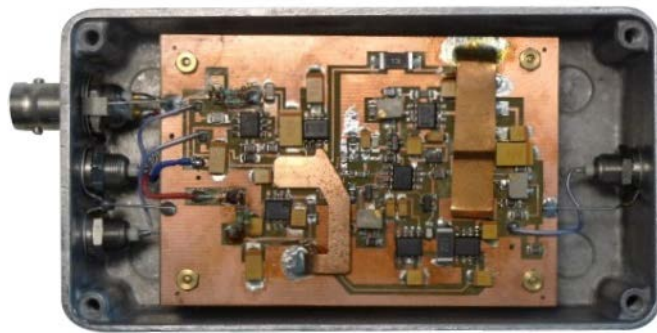

Fig. 1. Example of a dedicated front-end electronic module adapted for use with NaI(Tl) photon detector systems.

### B. HPGe Detector with Resistive Feedback Preamplifier

Initial tests on digitizing HPGe detector outputs focused on the signals generated by a conventional shaping amplifier. This required an adaptation of the front-end of the 14-bits ADC digitizer-system (AD92540) employed for this part of the work (Altera, Stratix III FPGA development kit). The input transformers were removed and replaced by a homemade interface based on a differential ADC driver chip (AD8136). This circuit is a low-noise single-ended-to-differential conversion circuit especially designed to drive modern ADCs. In addition, the electronic interface was designed to match the output voltage range of shaping amplifiers used in nuclear spectrometry (generally -12 V to +12 V) to the input specifications of the AD9254 chip (0 to 2 V) of the Altera device.

However, this initial adaptation of the system required the development of an additional electronic interface in order to process the pulses delivered by the preamplifier associated with a Canberra XtRa coaxial Ge detector (GX1518). The preamplifier stage consisted of a resistive feedback preamplifier (Canberra 2002C) with an output scale factor of the order of 500 mV/MeV. This additional front-end electronics interface has been described elsewhere [5] and its design is similar to the front-end previously described for the NaI(Tl) detector. The first stage consists of a wide-bandwidth buffer (AD811, Gain = 1) that offers the possibility to compensate for the baseline-shift of the preamplifier. The second component is a wide-bandwidth-voltage feedback clamp amplifier (AD8036, Gain = 1) with a clamp voltage set to  $\pm 2$  V (this setting can be modified). This clamp value combined with the gain of 5 provided by the third stage leads to a final conversion of 0.4 MeV/V. The third component is a high-voltage and wideband operational amplifier (THS4631, Gain = 5), which is implemented as a Rauch-type filter (Gaussian shape, total number of poles = 3). The purpose was to obtain an anti-aliasing filter that limits the bandwidth at high frequencies with a cut-off value (2.5 MHz) large enough to transmit the signal without deformation of the leading-edge. This third stage has also the possibility to drive a 50  $\Omega$  load. The maximum voltage delivered by this electronic interface is equal to 10 V, which corresponds to an energy of 4 MeV.

### C. SDD Detector with Reset Type Preamplifier

The detector set-up used was composed of a Silicon Drift Detector (SDD) produced by PNdetector (Type SD3-10-128pnW) connected to a reset-type preamplifier. The active volume was equal to 5.0 mm<sup>2</sup>  $\times$  0.45 mm. Measurements were carried out at a temperature equal to approximately  $-20$  °C using the Peltier unit attached to the detector. The energy resolution given by the manufacturer is equal to 127 eV FWHM for the Mn-K energy peak at 5.9 keV. The front end electronics employed was virtually identical to that described above for use with the HPGe detector.

### D. Proportional Counter with Charge Sensitive Preamplifier

Because proportional counters typically produce very small output signals, care must be taken to minimize noise at the input of the charge sensitive preamplifier, which typically incorporates a low noise FET input stage. In this work, no other front end electronics was utilized.

### E. Liquid Scintillation Counter with PMT

In this work, the digitizers were connected directly to the appropriate dynode of the associated PMT, with no other specialized front end electronics employed.

## III. DIGITAL PULSE PROCESSING (DPP)

Two approaches were employed to implement digital filters required to generate quantities of interest for a detected pulse: the particle energy (proportional to the charge released by the particle in the detector) and the arrival time of the pulse. The

first approach was to construct our own implementations of appropriate digital filters, based on a recursive implementation of a Gaussian filter (and its derivatives). The second approach was to utilize commercially available digitizer systems with in-built Digital Signal Processing capabilities. Here we selected several modules from CAEN (DT5720, DT5724 and DT5751), (Figure 2), each operating with a different Digital Pulse Processing (DPP) firmware applied by the FPGA, with the relevant energy and time-stamp information written to file for subsequent software processing. The digital filtration operates to perform noise rejection, baseline cancellation and perform shape and timing analysis. The timestamp generation is performed by transforming the pulses into bipolar signals whose zero crossing (pulse amplitude independent) can be used for accurate determination of the time stamp.



Fig. 2. The CAEN DT5720 digitizer.

### A. Implementation of a Recursive Gaussian Digital Filter

The recursive implementation of a Gaussian filter (and its derivatives) originally proposed by Young and van Vliet [6] for computer vision (image filtering, edge detection, etc.) was deemed a suitable candidate for construction of the digital filter. The algorithms were specifically developed for the processing of signals generated by photons detected in a high-efficiency well-type NaI(Tl) detector and a Silicon Drift Detector (SDD). In both cases, we used front-end electronics especially designed to optimize the coupling between the analog part and the digitization stage (14 bits, 125 MHz, installed in the Stratix III development kit) as described above. These algorithms (developed in MATLAB®) were applied to digitized pulse trains according to an off-line processing in a development phase in order to be programmed in future FPGA circuitry for on-line processing for routine measurements.

The actual implementation of the Gaussian filter algorithm has been reported elsewhere [7]. A smoothing filter (8-sample averaging) is first implemented on the digitized pulse trains in order to obtain a new original signal with an improved signal-to-noise ratio. The algorithm is then applied as a low-pass filter for pulse-height analysis corresponding to the “slow channel” in a classical instrumentation environment. The leading-edge detection is computed in the “fast channel” which uses the 1st derivative of the Gaussian filter. This differential operator generates fast signals that are used to trigger the dead-time management, the counting and the pulse-height analysis in the “slow channel”.

The Laplacian filter (2<sup>nd</sup> derivative of the Gaussian filter) is applied for pile-up identification by monitoring zero-crossings. (Figures 3 and 4).

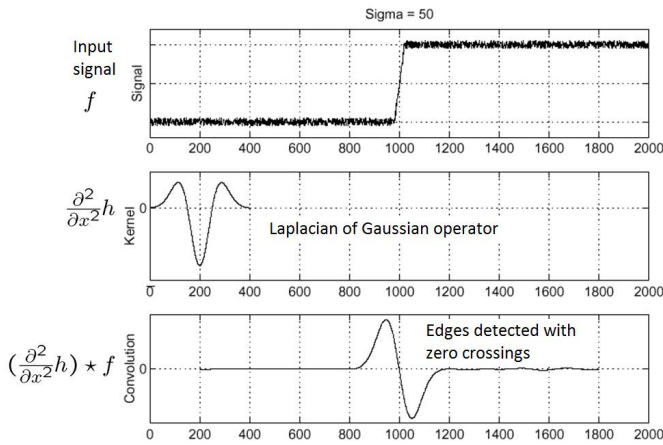

Fig. 3. Recursive Gaussian DPP Filter used for edge detection and timing optimization. The digitized input signal from the front end electronics ( $f$ ) undergoes a convolution with the second derivative (or Laplacian operator) of the Gaussian filter ( $h$ ).

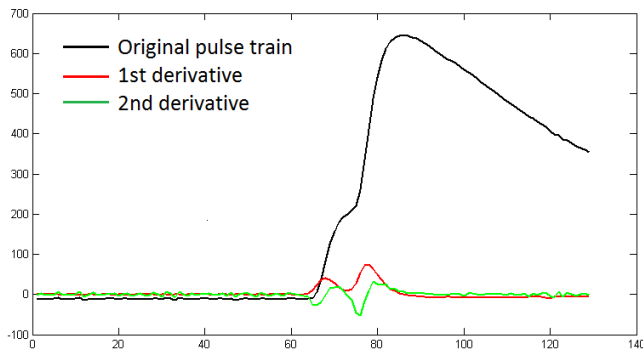

Fig. 4. (x-axis scale:  $\times 64$  ns). Example of the use of the algorithm for pile-up identification based on zero-crossing detection using the 2<sup>nd</sup> derivative of the Gaussian filter. The separation between output pulses is  $\sim 600$  ns, which is of the order of the rise time of the input pulse.

The detection of local maxima of the 1st derivative can be also used as a form of Constant Fraction Discriminator (CFD) to reduce the jitter-effect on the signal triggering. An example of the processing of the extendable dead time using the signals generated in the “fast channel” is given in Figure 5 (minimum duration set to 300 samples corresponding to  $\sim 19$   $\mu$ s).

Considering the “slow channel”, the differentiation is first computed by subtracting from the original pulse train the attenuated and delayed (24 samples,  $\sim 1.5$   $\mu$ s) original signal. The pole-zero compensation is set by the magnitude of the attenuation. The mean value of the offset on the original pulse train is continuously estimated prior the dead-time triggering. For the pulse-height analysis, the differentiated signal is smoothed using another implementation of the Gaussian filter. The amplitude is given by the first maximum value corrected for the baseline level of the differentiated signal measured prior the dead-time triggering.

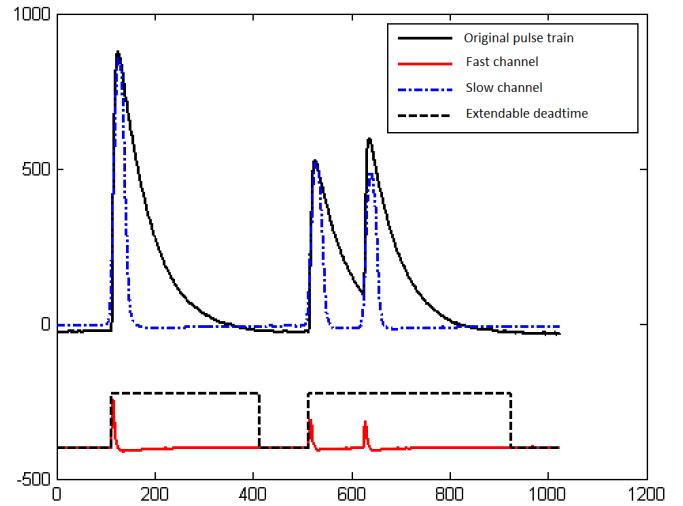

Fig. 5. (x-axis scale:  $\times 64$  ns). Digital pulse processing applied to signals delivered by a high-efficiency well-type NaI(Tl) detector. The “fast channel” is used to trigger the extendable dead-time management (minimum duration equal to 300 samples) and the pulse-height analysis in the “slow channel”.

### B. CAEN DPP-CI (Charge Integration)

The CAEN Charge Integration DPP firmware (DPP-CI) was implemented in the Model DT5720 (12 bit, 250MS/s) as well as the Model DT5751 (10 bit, 1GS/s) which were used to directly digitize the outputs from PMTs connected to Liquid Scintillation Counters and NaI(Tl) detectors, where the output pulses are of sufficient magnitude without the need for extra front end electronics. The DPP-CI forms the equivalent of an analog chain comprising a Charge Integrating ADC (QDC), discriminator and gate generator, and operates as shown in Figure 6.

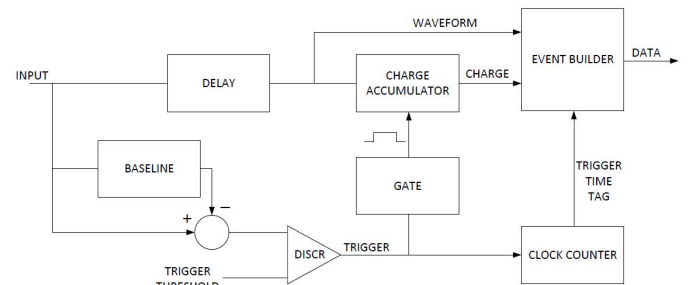

Fig. 6. Schematic representation of the CAEN DPP-CI firmware implementing the charge integration algorithm. (Adapted from [8]).

The DPP-CI integrates the total input charge but requires a gate signal to define the integrating window. This is generated from the input signal itself and requires splitting of the digitized input signal so that it is passed to both the discriminator (CFD) algorithm and also delayed so that the start of the input signal is aligned with the gate trigger. The zero-crossing of the derivative of the input signal is used to start this gate period, the length of which is matched to the width of the input signals (Figure 7). Further details may be found in the manufacturers Application Note [9].



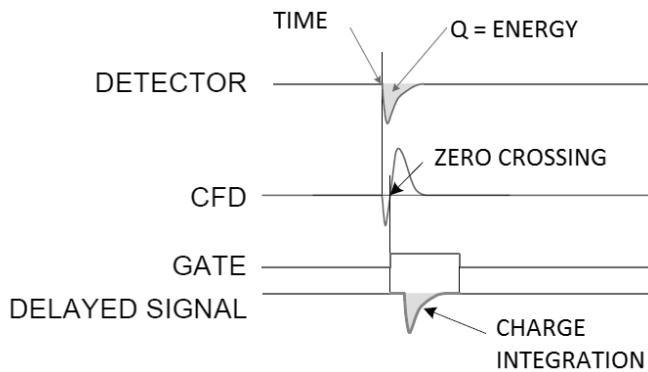

Fig. 7. Digital signals created in the DPP-CI firmware. (Adapted from [9]).

### C. CAEN DPP-PHA (Pulse Height Analysis)

The CAEN Pulse Height Analysis firmware (DPP- PHA) was implemented in the Model DT5724 (14 bit, 100MS/s) which was used to digitize the outputs from several charge sensitive preamplifiers and detector systems, as described in Section II. The DPP-PHA implements a “trapezoidal filter” or “moving window deconvolution filter” [10] which transforms the exponential shape of the input signal to a trapezoidal pulse with height proportional to the input pulse magnitude, via recursive convolution algorithms. The exponentially decaying input signal from the charge sensitive preamplifier is first convolved with a rectangular function, followed by a truncated ramp function. (Figure 8). Control of the filter parameters is achieved via user interaction with the control software. The DPP-PHA also generates a time stamp for each event, via means of a form of constant fraction discriminator, as described in the previous section, and thus logs the time and energy parameters in list-mode.

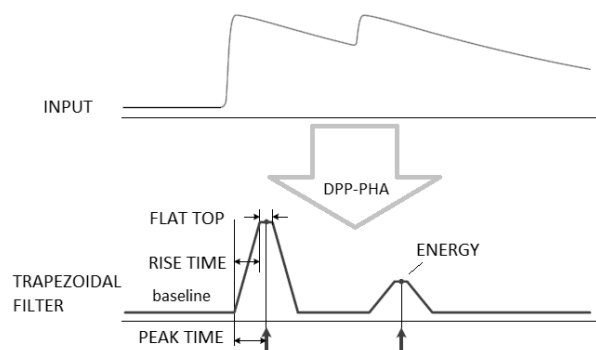

Fig. 8. Operation of the digital trapezoidal filter used in the CAEN DPP-PHA firmware. (Adapted from [11]).

### D. CAEN DPP-PSD (Pulse Shape Discrimination)

The CAEN Pulse Shape Discrimination DPP firmware (DPP-PSD) may be implemented in in the Model DT5720 (12 bit, 250MS/s) as well as the Model DT5751 (10 bit, 1GS/s). The algorithms employed are similar to those used in the DPP-CI firmware, but in this instance two charge integration gates (of short and long duration) are employed. Prior to registration of an event, the baseline of the input stream is calculated via a

moving average filter. This baseline level is subtracted from the input signal, and if the resulting digital code exceeds the user specified threshold level, a trigger is issued, and the baseline held constant. The two gates of user defined width are used to perform the charge integration, after applying a suitable delay to a copy of the input signal to ensure optimal charge integration. The time stamp of the trigger is calculated as described in the previous sections and logged to a list-mode data file along with the charged collected within the two gates. On completion of the “long” gate, the moving average baseline filter is restarted, and the process repeats with each subsequent pulse arrival. The DPP-PSD firmware then logs the time stamp, and the charge from both gates in list-mode. Although this DPP is designed for neutron-gamma discrimination in liquid scintillation detectors, one can easily operate this in the same manner as the DPP-CI by only utilizing the charge data from the “long” gate. Preliminary tests have been performed at ENEA-INMRI with the CAEN DT5720B device directly coupled to a homemade portable TDCR counter [12], [13], developed in the frame of the MetroFission project, by using a source of mixed  $^{241}\text{Am}$  and  $^{90}\text{Sr}$  for  $\alpha/\beta$  separation with the PSD technique.[12], [14].

## IV. COINCIDENCE COUNTING ON LIST-MODE DATA FILES

### A. Standard DCC Data Format

The list-mode data format from each of the above digitizer systems is unique, and in order to implement the  $4\pi\beta\text{-}\gamma$  digital coincidence counting (DCC) technique, a standard binary data format to pass between software functions was required. At present, there is no international standard data format for such measurements, and thus there are no “off the shelf” software routines to mimic the operation of the analogue electronic modules required to implement  $4\pi\beta\text{-}\gamma$  digital coincidence counting. A standard binary data format was developed within the MetroFission consortium, and all analysis routines used were produced as part of this project to accept data in this format. In all cases, the first function to be called is a data conversion routine, altering the various list-mode ASCII and binary data formats to this standard format.

Furthermore, a major proposal from this project was to instigate the development of an internationally recognized standard data format. To this end, the DCC task leader from the EMRP MetroFission project now leads a task within the newly established ERNCIP (European Reference Network for Critical Infrastructure Protection) Thematic Group on the Protection of Critical Infrastructure from Radiological and Nuclear Threats, which is pursuing the development of such a standard for list-mode data sets in radionuclide metrology. Proposals are presently being drafted to both the European Committee for Electrotechnical Standardization (CENELEC) and the International Electrotechnical Commission (IEC) Technical Committee 45 on nuclear instrumentation.

Support for this proposal has also been received from the International Committee for Radionuclide Metrology (ICRM) Working Group on Radionuclide Metrology Techniques.

## B. DCC Analysis Software

Data files (after conversion to the MetroFission internal data format) are then passed to a suite of dedicated software routines for an off-line implementation of the  $4\pi\beta\text{-}\gamma$  digital coincidence counting (DCC) technique. These routines include: dead time imposition, pulse interval digitizers, single channel analyzers, logic width and delay imposition, coincidence mixers, scalars, live-timers, multichannel analyzers etc.).

In all stages of software development a highly modular design was employed to readily facilitate the testing and validation of the various software components. The DCC data analysis routines were compiled in C++ as exportable functions residing in a 32-bit Dynamic Link Library (DLL), and the graphical user interface used to call these routines and present data to the user for interaction were compiled under the LabVIEW environment. A primary radionuclide standardization by the  $4\pi\beta\text{-}\gamma$  coincidence counting technique typically requires the processing of several millions of pulses (in order to achieve the required statistical precision) and since the user of the DCC system is free to replay the collected data sets through a range of different counting regimes, a great deal of emphasis was placed on maximizing the software execution speed.

## C. DCC Data Simulation

The validation of the correct operation of the DCC routines formed a major part of the project, and proceeded via the development (again in C++) of a Monte Carlo simulation program which generates digital data-sets with known characteristics for a simple simulated beta – gamma emitting nuclide in the appropriate format.

Inputs to the Monte Carlo model include: the total number of disintegrations to simulate, the source activity, the ADC sampling frequency, the detector efficiencies for various nuclear and atomic emanations, the beta channel spectral shape, the internal conversion coefficient for the gamma transitions, simulated pulse widths and random jitter, among many others. Appropriate transformations of uniform random variates are used to determine the exponentially distributed intervals between successive nuclear disintegrations, the amplitudes assigned to registered pulses and their final time stamps.

Each simulated nuclear disintegration yields a beta particle, with a pulse height sampled from the input beta spectral shape distribution. According to the input internal conversion coefficients, either a simulated gamma ray or conversion electron is produced. The fate of these particles is determined according to the input detector efficiency parameters.

The fact that the simulated pulses exhibit finite widths and exponentially distributed inter-arrival times leads to the possibility of pulse pile-up occurring between responses due to different parent decays. The model keeps a record of all recorded pulse start-times and pulse-shapes from each channel, performs a summation of the responses where appropriate and “extends” the pulses accordingly. The time assigned to each event registered is constructed from the sum

of all prior intervals, augmented with any simulated random time “jitter” and/or constant delay.

Extensive testing of the operation of the DCC analysis routines with these simulated data sets proved invaluable in the development (and associated debugging) of the software. In all cases, the output of the routines agreed with simulation inputs, demonstrating correct behavior.

## D. DCC Software Examples

Figures 9–11 demonstrate some of the powerful capabilities of the DCC analysis software. A further publication (in progress) will detail the design, operation and testing of the software.

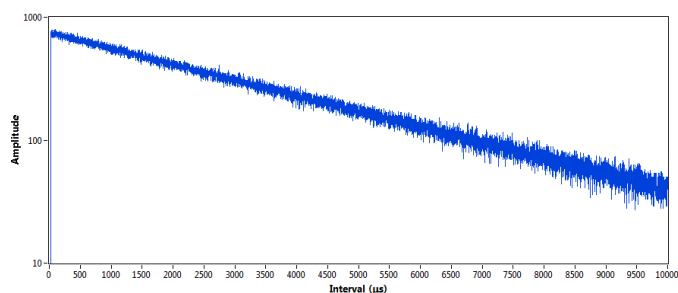

Fig. 9. The exponential interval distributions calculated from the list-mode data from a CAEN DT5720 digitizer, for a  $^{60}\text{Co}$  source in an atmospheric proportional counter.

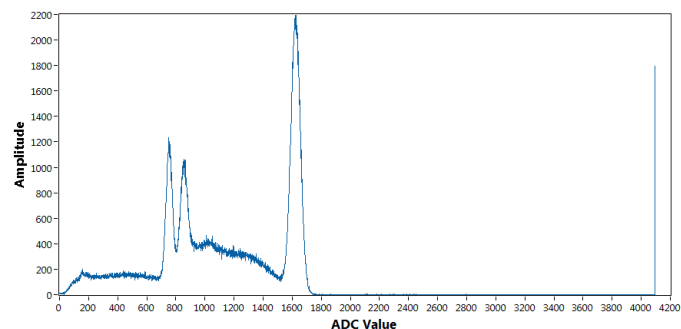

Fig. 10. The gamma spectrum calculated from a  $^{60}\text{Co}$  source in a large (5 inch) NaI(Tl) well-detector. The digitization was performed by a CAEN DT5751 module.

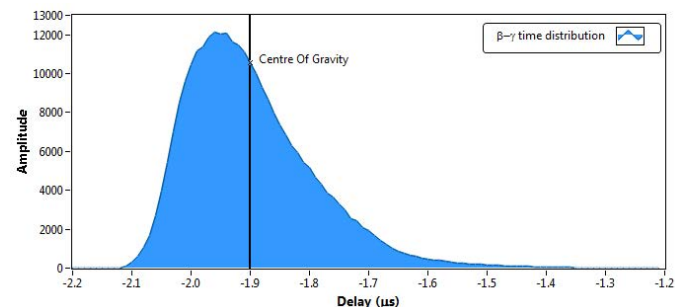

Fig. 11. The time-delay distribution between beta and gamma pulses for a  $^{60}\text{Co}$  source measured in a  $4\pi\beta\text{-}\gamma$  configuration at ENEA. The beta channel used was an atmospheric proportional counter and the gamma channel comprised an NaI(Tl) detector. The digitizer used was a CAEN DT5720.

## V. CONCLUSIONS

Significant progress has been made towards the enhancement of portable, robust (and transparent) primary standards of radioactivity. Signals from various radiation detectors have been digitally sampled at state-of-the-art sampling frequencies ( $10^8$  -  $10^9$  samples per second). The software to analyze these recorded pulse trains is complete and will routinely be used in international comparison exercises for reporting the activity concentration for a variety of nuclides. An international effort is underway to develop a standard data format for "list-mode" data sets used in radionuclide metrology.

## REFERENCES

- [1] International Commission on Radiation Units and Measurements, "Particle counting in radioactivity measurements". ICRU Report 52, Bethesda, MD, 1994.
- [2] C. Bobin, "Primary standardization of activity using the coincidence method based on analogue instrumentation". *Metrologia*, vol. 44, no. 4, pp. S27-S31, 2007.
- [3] J.D. Keightley and T.S. Park, "Digital Coincidence Counting for radionuclide standardization". *Metrologia*, vol. 44, no. 4, pp. S32-S35, 2007.
- [4] H. E. Rauch, F. Tung, and C. T. Striebel, "Maximum likelihood estimates of linear dynamic systems," *AIAA Journal*, vol. 3, no. 8, pp. 1445-1450, 1965.
- [5] C. Bobin, J. Bouchard, S. Pierre and C. Thiam, "Overview of a FPGA-based nuclear instrumentation dedicated to primary activity measurements", *Appl. Radiat. Isot.*, vol. 70, pp. 2012-2017, 2012.
- [6] I.T. Young and L.J. van Vliet, "Recursive implementation the Gaussian filter", *Signal Process.* vol. 44, pp. 139-151, 1995.
- [7] C. Bobin. "Digital pulse processing and optimization of the front end electronics for nuclear instrumentation", to be published.
- [8] G. Mini, F. Pepe, C. Tintori and M. Capogni. "A full digital approach to the TDCR method", to be published, ICRM 2013 conference.
- [9] *Charge Integration: Analog Vs. Digital*, CAEN Application Note AN2503, CAEN SpA, Viareggio, Italy, 2010.
- [10] V.T. Jordanov and G.F. Knoll, "Digital Synthesis of pulse shapes in real time for high resolution radiation spectroscopy", *Nucl. Inst. Meth. A*, vol. 345, pp. 337-345, 1994
- [11] *CAEN digital pulse analyser- a digital approach to Radiation Spectroscopy*. CAEN Application Note AN2508, CAEN SpA, Viareggio, Italy, 2010.
- [12] M. Capogni, P. De Felice. « A prototype of a portable TDCR system at ENEA". To be published, LSC 2013 conference.
- [13] P. Cassette, M. Capogni, P. De Felice, L. Johansson, K. Kossert, O. Nahle, J. Sephton. "Development of portable Liquid Scintillation counters for on-site primary measurement of radionuclide using the Triple to Double Coincidence Ratio method". Submitted to ANIMMA conference, June 2013
- [14] P. Butkus. "Study of the TDCR technique by a newly developed software for the off-line coincidence counting and digitized data analysis". Thesis carried out at ENEA-INMRI (Supervisor: M. Capogni) in the frame of the ERASMUS EU Lifelong Learning Programme for the degree of Bachelor in Physics of Nuclear Energy. Faculty of Physics, Vilnius University. Lithuania. June 2013