



HAL
open science

Intrinsic evaluation of n/γ discrimination in organic plastic scintillators

Pauline Blanc, Matthieu Hamel, Licinio Rocha, Stéphane Normand, R. Pansu,
F. Gobert, I. Lampre

► **To cite this version:**

Pauline Blanc, Matthieu Hamel, Licinio Rocha, Stéphane Normand, R. Pansu, et al.. Intrinsic evaluation of n/γ discrimination in organic plastic scintillators. 2013 3rd International Conference on Advancements in Nuclear Instrumentation, Measurement Methods and their Applications (ANIMMA), Jun 2013, Marseille, France. pp.06727919, 10.1109/ANIMMA.2013.6727919 . cea-01822340

HAL Id: cea-01822340

<https://cea.hal.science/cea-01822340>

Submitted on 1 Aug 2023

HAL is a multi-disciplinary open access archive for the deposit and dissemination of scientific research documents, whether they are published or not. The documents may come from teaching and research institutions in France or abroad, or from public or private research centers.

L'archive ouverte pluridisciplinaire **HAL**, est destinée au dépôt et à la diffusion de documents scientifiques de niveau recherche, publiés ou non, émanant des établissements d'enseignement et de recherche français ou étrangers, des laboratoires publics ou privés.

Intrinsic Evaluation of n/γ Discrimination in Organic Plastic Scintillators

Pauline Blanc, Matthieu Hamel, Licinio Rocha, Stéphane Normand, Robert Pansu, Fabrice Gobert and Isabelle Lampre

Abstract—This paper is devoted to characterizing plastic scintillators with neutron/gamma (n/γ) discrimination abilities and understanding experimentally the photophysical processes downstream. This experimental work is divided into two main studies, neutron sources irradiations and optical photoionization on a range of organic scintillators. The commercial liquid and plastic scintillators, respectively BC-501A from Bicon and EJ-200 from Eljen, are used as references in term of respectively extremely high [1] and poor n/γ discrimination efficiency, or more precisely Triplet-Triplet Annihilation rate probabilities after nuclear irradiations. We have characterized a range of organic plastic scintillators including one developed in our laboratory that shows good discrimination efficiency when compared to plastics that discriminate from litterature. For that purpose we use the well known charge comparison as a pulse shape discrimination (PSD) method. We have also studied raw wave forms acquired after neutron irradiation before any kind of treatment was applied and managed to separate two light components, prompt and delayed, thus two particle families. We have demonstrated that by exciting with a 70 femtoseconds pulsed LASER at the femtosecond up to 50 μJ at 260 nm, photoionization was achieved for a range of organic scintillators by observing a delayed light emission in the time decay fluorescence when the LASER energy deposited in the materials was increased. This work is ongoing at CEA in collaboration with the nuclear measurement industry Canberra and the Laboratoire de Chimie Physique from Orsay University.

Index Terms—Organic Plastic Scintillators, Direct Fast Neutron Detection (DFND), n/γ Discrimination, Pulse Shape Discrimination (PSD), Femtosecond LASER photolysis, Photoionization, Triplet-Triplet Annihilation (TTA).

I. INTRODUCTION

Nuclear detection through fast neutron for nondestructive assay (NDA) applications to characterize radioactive materials can be achieved through organic scintillators. They

require gamma background discrimination to the neutron signal for neutron flux determination.

A large range of neutron detectors exist for the applications that we aim, waste management (WM), Homeland Security (HS) or nonproliferation. They are divided into two categories, thermal and fast neutron detectors. Requirements are well defined to qualify a neutron detector and are related to the neutron detection efficiency, the gamma signal rejection and its ability to discriminate the gamma background from neutrons, these alarm thresholds are presented in Kouze et al. report [2].

Thermal neutron detectors satisfy these parameters. The most commonly used thermal neutron detectors are ^3He gas-filled proportional counters. However ^3He shortage requires alternatives to be found urgently [3]. A comprehensive list is given in the paper of Peerani et al. [4] and are especially mentioned gas-filled $^{10}\text{BF}_3$, boron-lined thermal neutron detectors and organic scintillators via direct fast neutron detection (DFND).

This list can be shorted out by pointing out that boron fluoride gas is highly toxic and boron-lined detectors have low neutron detection efficiencies, about 7 times lower than ^3He counters [4]. Therefore best candidates are organic scintillators. In addition to being a non expensive technology and direct fast neutron detectors, they do not require thermalizing materials surrounding making integrated system less practical. They present intrinsic efficiencies about 2 times as good as ^3He counters as Hansen et al. [5] reports and even 4 to 8 times as good as Peerani et al. reports [4] for equivalent geometries and incident energies.

Crystal liquid or plastic organic scintillators are the best candidates for ^3He replacement. However some drawbacks remain unsolved and are the topic of the present paper. Crystals are not industrially adapted given their high cost and difficulties to be grown in acceptable sizes. Liquid scintillators have a low flash point and require to constantly remain isolated from oxygen to avoid any scintillation quenching that would decrease significantly their n/γ discrimination efficiency [6]. At last organic plastics present very poor discrimination compared to crystals and liquids, however its specificities, large sizes at low cost and insensitivity to luminescence quenching, make them very attractive for the applications we aim, and identifying the main mechanisms appears as being a key issue.

n/γ discrimination proceeds by luminescent components separation after ionization as a result of either singlet (S) or triplet (T) excited states formation. γ and n are respectively responsible for populating S and T states and from those to generate prompt and delayed luminescence. After

Corresponding author. Tel: +33 1 69 08 53 24, e-mail address: pauline.blanc@cea.fr (Ms. Blanc)

Manuscript received November 15, 2012.

Ms. Blanc is with CEA, LIST, Laboratoire Capteurs et Architectures Électroniques, F-91191 Gif-sur-Yvette, France. Telephone: 33 1 69 08 53 24, e-mail: pauline.blanc@cea.fr and Laboratoire de Photophysique et de Photochimie Supramoléculaire et Macromoléculaires UMR 853 CNRS ENS Cachan, F-94235 Cachan, France.

M. Hamel L. Rocha and S. Normand are with the CEA, LIST, Laboratoire Capteurs et Architectures Électroniques, F-91191 Gif-sur-Yvette, France. E-mails: matthieu.hamel@cea.fr, licinio.rocha@cea.fr, stephane.normand@cea.fr

R. Pansu is with Laboratoire de Photophysique et de Photochimie Supramoléculaire et Macromoléculaires UMR 853 CNRS ENS Cachan, F-94235 Cachan, France. E-mail: pansu@ppsm.ens-cachan.fr

F. Gobert and I. Lampre are with Laboratoire de Chimie Physique Bâtiment 349, ELYSE, Université d'Orsay, F-91405 Orsay, France. E-mails: fabrice.gobert@u-psud.fr, isabelle.lampre@u-psud.fr

γ -interactions, electrons produced originate the prompt component emitted from $S_1 \rightarrow S_0$ direct de-excitation whereas protons recoil after n -interactions lead to T-T annihilations processes (TTA) consisting in $T_1 + T_1 \rightarrow S_0 + S_1$ followed by a $S_1 \rightarrow S_0$ delayed de-excitation. Higher the TTA rate is better the separation is.

While prompt and delayed components separation for n/γ discrimination can easily be achieved in some liquids or crystals, it is more difficult in plastics. Photophysical processes comprehension involved in plastics compared to other organic media forms the basis of the proposed investigations.

Light components are not separated for most plastics. However three plastic scintillators synthesized in 1960 [7], very recently in 2012 [8] and [9] show good discrimination virtues. As well as the development of a new discriminating plastic scintillator in our laboratory Hamel₂₀₁₃.

The end goal is to understand the photophysical phenomena after neutron interactions that differentiate liquid from plastic media by observing experimentally light delayed components and identifying the nature of related excited state and energy transfers. This understanding is crucial for plastic scintillators industrial development to replace liquids, crystals being non-adapted alternatives to ^3He , especially cost wise.

Firstly a detailed description of photophysical processes is provided [10] [11].

Secondly, raw wave forms analysis generated by irradiating organic scintillators with neutron sources, and by that we mean mixt neutrons and gamma sources, is presented and lead to the separation of two particles families, neutron and gamma, according to their decay time behavior.

Thirdly, nuclear experiments with neutron sources, using charge integration techniques allowing light components separation are described together with promising results on a plastic scintillator that discriminates.

Fourthly, femtosecond LASER experiments are described as an attempt to simulate nuclear interactions and show that photoionization can be achieved which allows us to go forward confidently with transient species absorption spectroscopy to identify energy transfers occurring in the organic material.

Scintillators that have been tested are the following :

- A commercial liquid scintillator from Bicron : BC-501A
- A commercial plastic scintillator from Eljen : EJ-200
- A plastic scintillator developped in our laboratory at 17% concentration of the first dye and a secondary dye at lower concentration : Sample 1
- A plastic scintillator developped in our laboratory at 17% concentration of the first dye adding a secondary first dye and a secondary dye at lower concentration : Sample 2

II. PHOTOPHYSICAL PROCESSES LEADING TO n/γ DISCRIMINATION

An organic scintillator is basically made of a solvent and a fluorophore, respectively a donor and an acceptor, in term of energy transfer, that can also be expressed in terms of exciton migration. Hereafter a simplified explanation gives the general process following n and γ interactions with organic material.

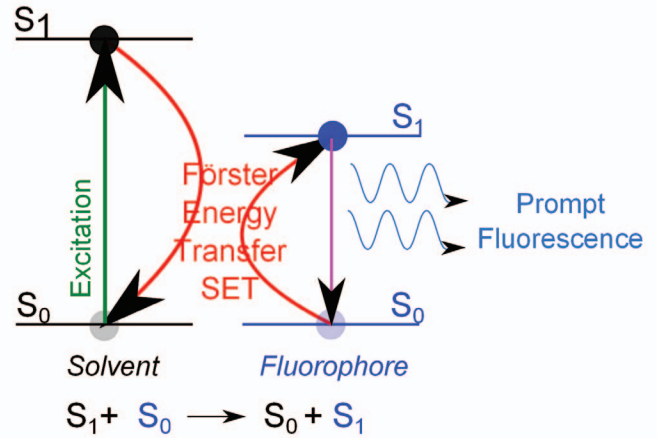

Fig. 1: After γ interactions with an organic scintillator, S excited states of the solvent are created and energy transfers take place between the solvent (donor) and the fluorophore (acceptor), Förster energy transfers, giving rise to prompt fluorescence.

The difference comes from the high energy density deposition along a n -track allowing electrons/holes cross recombination favoring Triplet states creation unlike along a γ -track where Singlet states are favored.

γ -rays ionize the organic medium and free electrons [12] thereafter recombine with the molecule they originate from since the density of ionized species is low and thus the probability to recombine with another molecule also, S states are thus favored. Fig. 1 details energy transfers giving rise to prompt luminescence in a simple {solvent, fluorophore} organic scintillator after gamma interactions.

n transfer their energy to recoil protons. These ionize the organic medium. Because of their high energy density deposition, ionized species can be close enough, to present an interaction at a radius lower the Debye distance. Therefore excitons can recombine with closeby molecules to form Triplet states. Fig. 2 details energy transfers leading to delayed luminescence after neutron interactions.

These two prompt and delayed light components can be separated and γ from n discriminated using pulse shape discrimination (PSD) methods, in particular, the charge comparison.

III. RAW WAVE FORM ANALYSIS TO IDENTIFY PARTICLES FAMILIES

Wave forms were analyzed before any kind of treatments as described Fig. 3. Organic scintillators, both a liquid, known for its high n/γ discrimination efficiency [1] which is used as a reference, and plastic are irradiated with a neutron source, ^{252}Cf at 1 MBq placed 5 cm away from the scintillator with no shielding. The emitted light is collected in a Hamamatsu photomultiplier (PM) under high voltage. The pulse is then acquired by a Lecroy Oscilloscope. The plastic scintillator showed here is a new discriminating plastic scintillator developed in our laboratory and is designated by the appellation

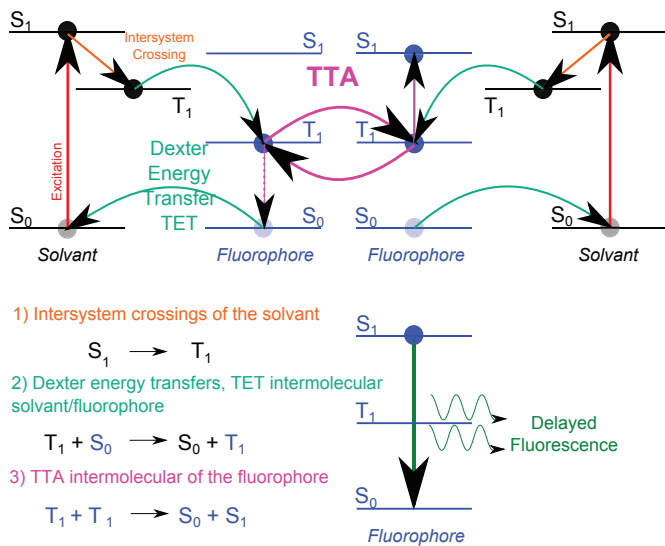

Fig. 2: After n interactions with an organic scintillator, T excited states of the solvent are created and energy transfers take place, Dexter energy transfers before T states from the fluorophore undergo TTA and give rise to delayed fluorescence.

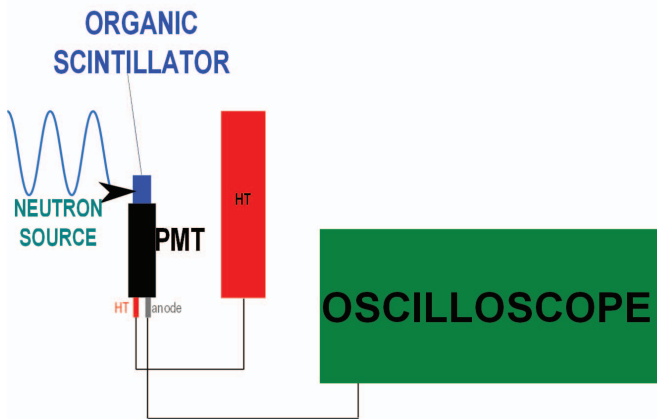

Fig. 3: Experimental set-up of raw wave forms acquisition after neutron irradiation of organic scintillators for particle nature determination.

Sample 1 and is composed of a first fluorophore at 17% concentration and a secondary fluorophore at lower concentration. A patent has been filed [13]. Here the plastic is \varnothing 30 mm x h 30 mm.

A. Liquid Organic Scintillator BC-501A with Very High n/γ Discrimination Efficiency

Pulses from the liquid scintillator BC-501A have been collected, the PM is under tension at 2000 V. About 4000 wave forms have been analyzed and by integrating signals we have managed to separate two particle natures, 1072 neutrons and 2805 gamma rays that have then been averaged and normalized. Results are presented in Fig. 4 evidencing a very clear delayed component.

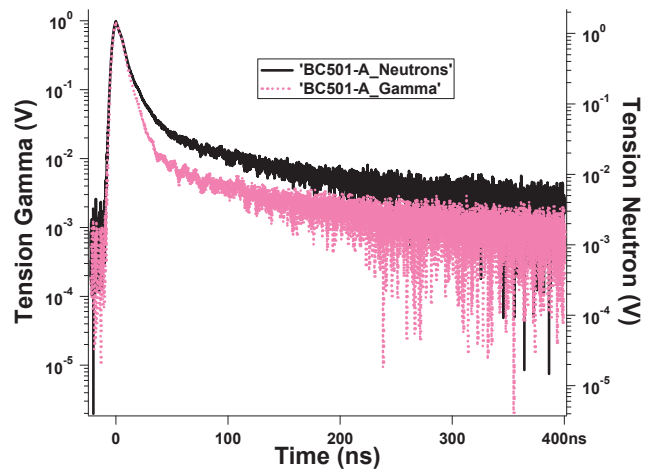

Fig. 4: Neutrons and Gamma decay fluorescence outcoming from a neutron irradiation ^{252}Cf of the commercial liquid scintillator BC-501A with very good n/γ discrimination properties.

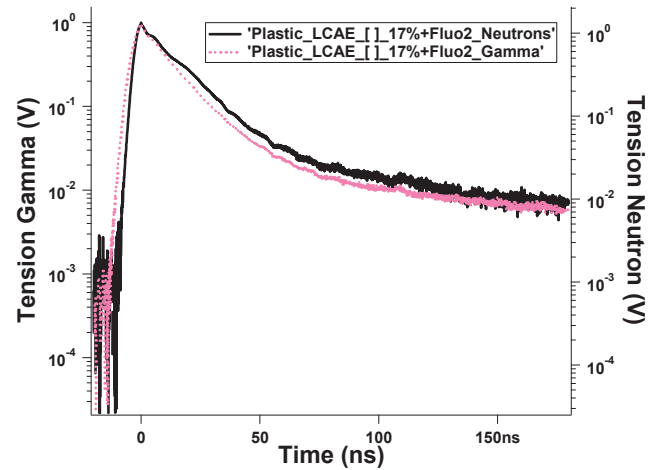

Fig. 4: Neutrons and Gamma decay fluorescence outcoming from a ^{252}Cf irradiation of a plastic scintillator with good n/γ discrimination properties.

B. Sample 1 Organic Scintillator with Good n/γ Discrimination Efficiency

Pulses from the Sample 1 have been collected, the PM is under tension at 1600 V.

Fig. 5 shows a difference in the fluorescence decay evidencing the gamma to the neutron family. About 12 000 wave forms have been analyzed and by integrating signals we have managed to separate two particle natures, 1572 neutrons and 11 034 gamma rays that have then been averaged and normalized. Further work is going to quantify these decay with a range of new experiments dedicated to separate the particles family according to the incident energy. Also preliminary work has proved that energy spectra of both neutrons and gamma can be extracted from these experiments enabling a calibration in term of electron equivalent energy. This work will be used to support LASER experiments, presented below

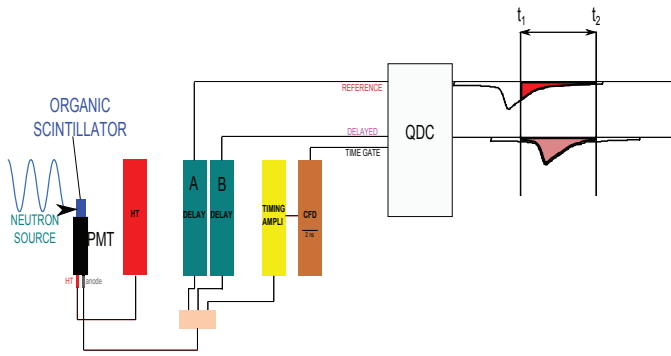

Fig. 6: Experimental set-up of the charge integration comparison method for n/γ discrimination.

in the devoted section, that also show significant difference in the fluorescence decay when photoionization is achieved and T excited states generated in densities allowing TTA to occur and correlations are likely to be achieved given the results already obtained.

IV. PULSE SHAPE DISCRIMINATION WITH A PLASTIC SCINTILLATOR

Nuclear experiments using the charge integration technique allowing light components separation have been performed. The experimental set-up is described in Fig. 6. To perform these experiments a ^{252}Cf neutron source placed 5 cm away from the scintillator with no shielding is used. A range of organic plastics and a liquid scintillator are characterized using a PM to collect light and a QDC to integrate both total and delayed signals in a TTL time gate generated by a constant fraction discriminator (CFD) from ORTEC. The gate width together with a range of electronic devices set-up that have to be properly chosen according to the organic scintillators studied are key parameters to optimize discrimination experiments. Here scintillators have been studied in the same electrical conditions.

Fig. 6 displays the experimental set-up used as a PSD method. Energy spectra are built from the subtraction of the delayed charge to the total charge, unless otherwise specified, as the main charge deposited in the organic medium, proportional to the energy deposited.

A. Liquid Organic Scintillator BC-501A with Very High n/γ Discrimination Efficiency

Fig. 7 shows both the energy spectrum of the BC-501A using a ^{22}Na of 9.75 MBq placed at 5 cm away from the scintillator and the bidimensional spectrum calibrated in term of energy electron equivalent of the delayed to total charge ratio. As expected with this commercial scintillator used as a reference the discrimination is very clear due to the high TTA rate.

B. Plastic Organic Scintillator EJ-200 with Very Poor n/γ Discrimination Efficiency

Fig. 8 shows the bidimensional spectrum of the delayed as a function of the total charge for the EJ-200 plastic scintillator,

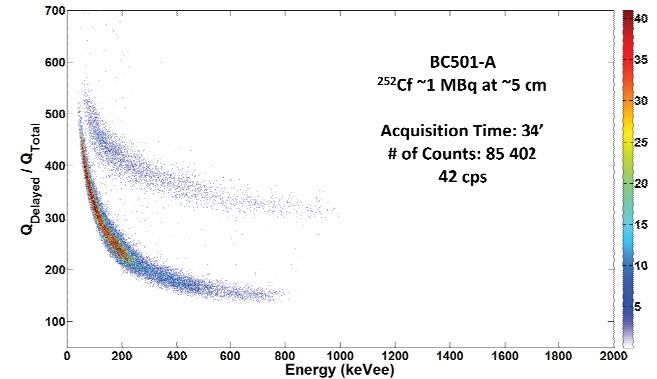
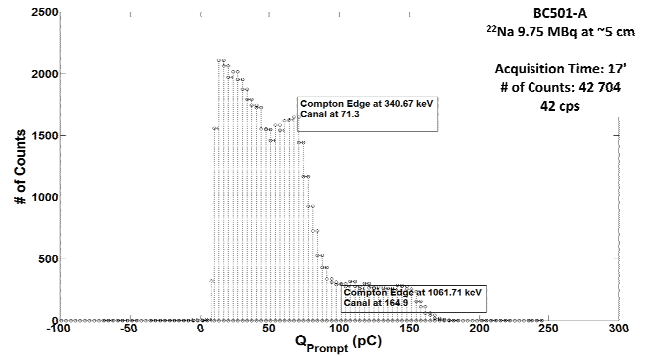

Fig. 7: ^{22}Na spectrum in the upper part and n/γ discrimination spectrum below, calibrated in electron equivalent energy in a highly efficient discriminating liquid organic commercial scintillator, BC-501A.

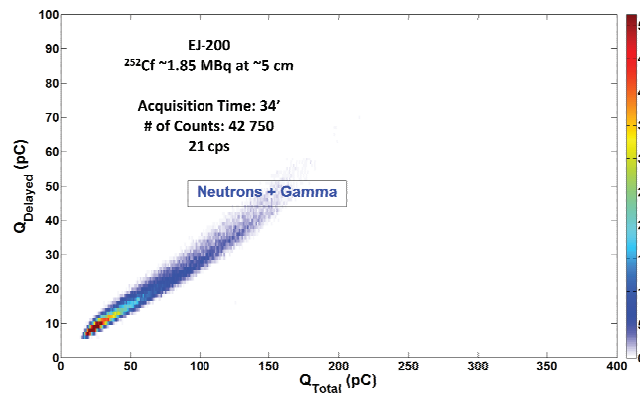

Fig. 8: n/γ discrimination spectrum, an inefficient commercial plastic scintillator, EJ-200.

used as a reference in term of plastic scintillator with no discrimination properties. As expected with this commercial scintillator the discrimination seems absent.

C. Plastic Organic Scintillator with Good n/γ Discrimination Efficiency

Fig. 9 shows the Sample 1 bidimensional spectrum of the delayed as a function of the total charge. This organic plastic scintillator shows clear discrimination properties that are quantified below.

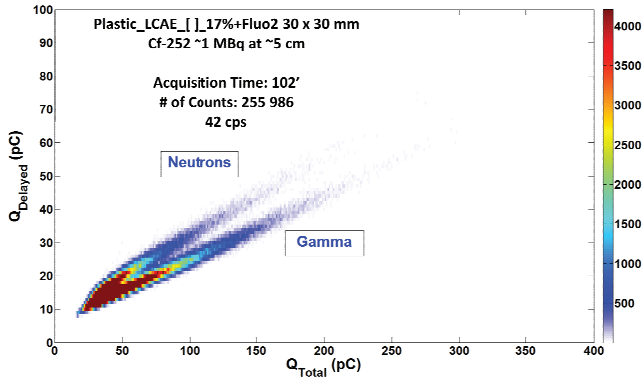

Fig. 9: n/γ discrimination spectrum in an efficient discriminating Sample 1 (ϕ 30 mm x h 30 mm) organic scintillator at a concentration of 17% as for the first fluorophore and a secondary fluorophore in low concentration.

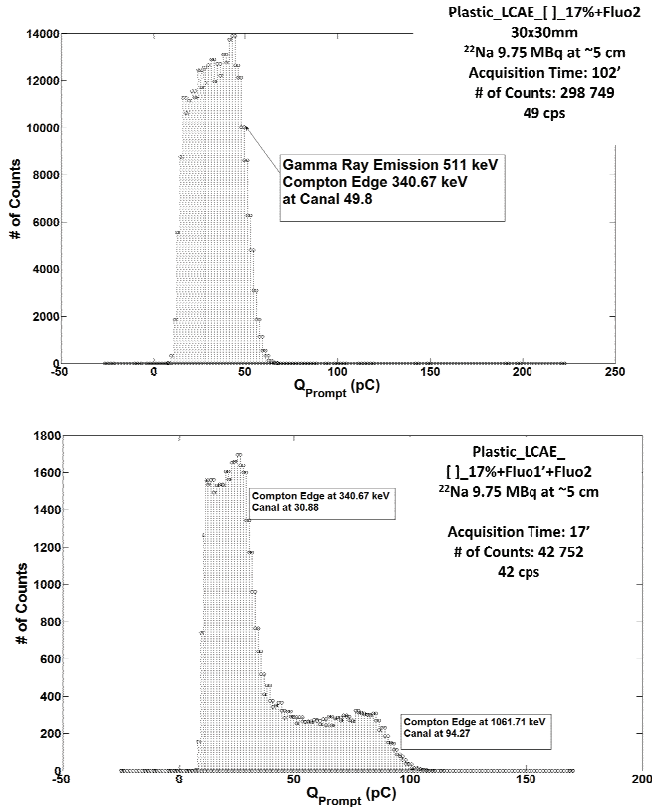

Fig. 10: ^{22}Na energy spectrum from Sample 1 (ϕ 30 mm x h 30 mm) upward and adding a secondary first fluorophore, below, Sample 2.

Fig. 10 the energy spectra of the Sample 1 using a ^{22}Na of 9.75 MBq placed at 5 cm away from the scintillator is given together with Sample 2, where a secondary first fluorophore has been added.

As a matter of fact Fig. 10 shows that the energy spectrum from the Sample 1 [13] is quite poor since the secondary compton edge at 1061.72 keV does not build in the way we have measured it. However further experiments performed

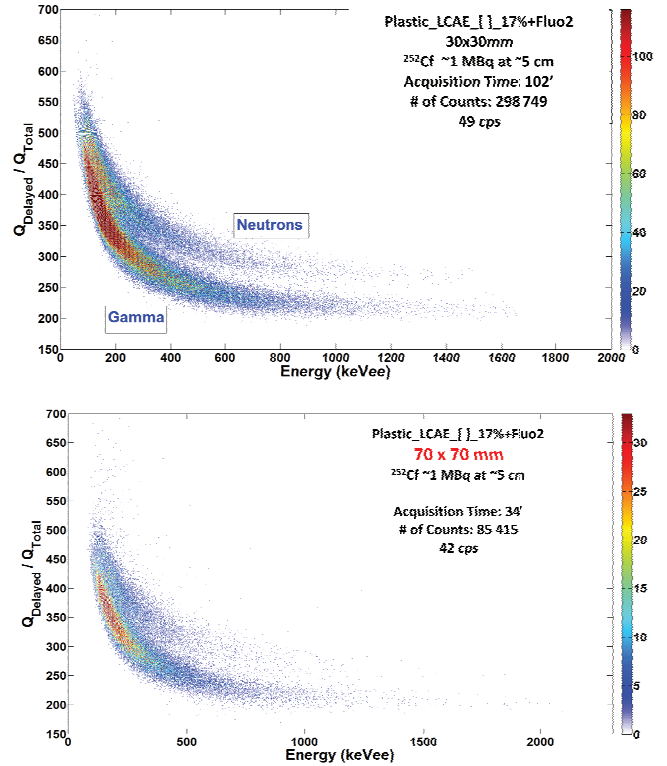

Fig. 11: n/γ discrimination spectra calibrated in electron equivalent energy in an efficient plastic (ϕ 30 mm x h 30 mm) Sample 1 for two different morphologies, ϕ 30 mm x h 30 mm and ϕ 70 mm x h 70 mm.

differently and presented below show a better energy spectrum of this same plastic. Also the Sample 2 where a secondary first fluorophore has been added from Sample 1 genuine composition, retains its discrimination properties therefore we believe that we will easily improve the organic scintillator composition for better light emission.

In Fig. 11 discrimination spectra calibrated in term of energy electron equivalent are presented for the Sample 1 at two different morphologies both ϕ 30 mm x h 30 mm and ϕ 70 mm x h 70 mm.

Fig. 11 shows that even when increasing the volume, the plastic developed in our laboratory retains its discrimination properties.

D. n/γ Discrimination Efficiency Quantification

Previous conclusions are confirmed by Fig. 12 where figure of merits (FOM) calculated as described in Eq. 1 of a given discrimination spectrum calibrated at a given energy electron equivalent are presented. $D_{\gamma-n}$ is the distance between the two centroids of a given Z projection of the gamma and neutron gaussians and $L_{\gamma-10}$ and L_{n-10} are respectively the width at the 10th of the neutron height.

$$FOM = \frac{D_{\gamma-n}}{L_{\gamma-10} + L_{n-10}} \quad (1)$$

Results presented Fig. 12 show that, as expected the liquid stands far above all 4 other organic plastic scintillators in terms

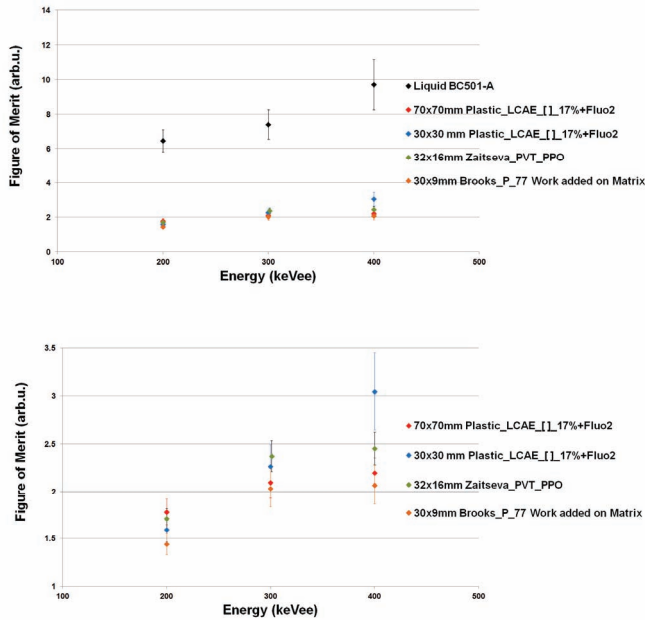

Fig. 12: Figure of merits calculated for the reference liquid commercial organic scintillator with highly efficient discrimination properties, BC-501A, Sample 1 for two different morphologies, ϕ 30 mm x h 30 mm and ϕ 30 mm x h 30 mm, the PVT-PPO plastic scintillator from Zaitseva et al.[9] reproduced in our laboratory with good discrimination properties and a plastic 77 from Brooks et al. [7] reproduced in our laboratory adding some work on the matrix. Standard deviations have been determined and propagated.

of discrimination efficiency. All plastic scintillators stand in the same discrimination efficiencies reaching about 2.2 at 300 keVee. Ongoing work is dedicated to calibrate with further sources the discrimination spectra to confirm these results.

E. Light Yield and Count Rates Considerations

The light yield and the count rate of the Sample 1 has been quantified comparing its properties to those of the reference commercial plastic scintillator EJ-200 for 3 different sources ^{22}Na , ^{137}Cs and ^{60}Co . These comparisons have been performed in the same exact conditions with a different experimental set-up than described above, based on the maximum of the amplitude, for similar morphologies at ϕ 30 mm x h 30 mm. Results are displayed Fig. 13.

Fig. 13 shows that the Sample 1 has light yield that could be optimized compared to the EJ-200, 10 000 photons per MeV but a rather high count rate.

In conclusion promising discrimination results have been obtained, the plastic we have developed and under further optimization seems to have good TTA rate.

Furthermore we like to prove experimentally that TTA rates originate n/γ discrimination thanks to LASER photolysis experiments as presented below.

LCAE_Plastic_I1_17%+Fluo2
Count Rate and Light Yield
Referenced to EJ-200: 10,000 ph/MeV

Source	^{22}Na	^{137}Cs	^{60}Co
Activity	9.75 MBq	$206 \pm 10\%$ kBq	$240 \pm 10\%$ kBq
Count rate (norm. EJ-200)	84 %	75 %	87 %
Lightyield (ph/MeV)	5,700	4,400	6,800

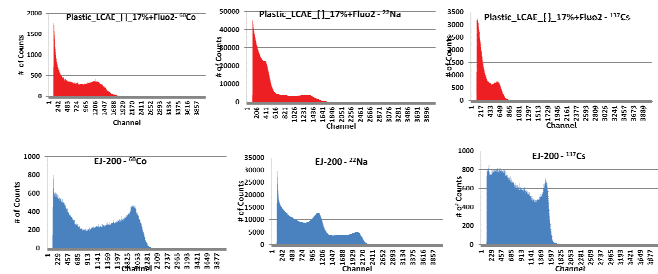

Fig. 13: Light yield and count rates measurements for Sample 1 in comparison with the EJ-200 reference commercial plastic scintillator for 3 different sources ^{22}Na , ^{137}Cs and ^{60}Co for similar morphologies at ϕ 30 mm x h 30 mm.

V. FEMTOSECOND LASER EXPERIMENT FOR PHOTOIONIZATION, FLUORESCENCE DECAY ANALYSIS

This experiment is performed as an attempt to simulate nuclear interactions with organic scintillators. This to produce T states in densities allowing TTA to occur and delayed light components obtained. That would allow to confidently perform further transient species absorptions experiments on the same scintillators to describe energy transfers. The experimental set-up is described Fig. 14.

The fundamental frequency of a Ti:Sa LASER delivering 70 fs pulses at 780 nm is tripled to excite samples with a 260 nm beam which intensity can be tuned up to $50 \mu\text{J}$ at 260 nm, measured after the tripler. The beam diameter is decreased to 2 or 4 mm after which it can reach respectively 10 and $25 \mu\text{J}$. We have tested a range of plastics, ϕ 25 mm x h 5 mm, including the commercial plastic EJ-200 with no discrimination properties as a reference and the Sample 1 and the reference liquid scintillator with high discrimination efficiency BC-501A for reference also. In the case of liquid experiments we have used a device allowing to put the sample in motion randomly, using a thin cell of 1 mm thick. Regarding the plastic we have used a device allowing to rotate the sample at the same speed for all plastics shifting the beam from the center of the scintillator. In order to insure not illuminating twice the same position we have varied the LASER repetition rate thanks to a choper accordingly, reducing the repetition rate by a factor of 10, originally the LASER repetition rate is 1000 Hz. Also all experiments have been performed at the same amplitude received by the PM, 500 mV, for that matter we have used optical densities and diaphragms accordingly. The PM is under tension at 1300 V for all experiments. Linearity of the response has been verified in these conditions. All pulses presented have been averaged over 4000 wave forms for liquids and 2000 for plastics and then normalized.

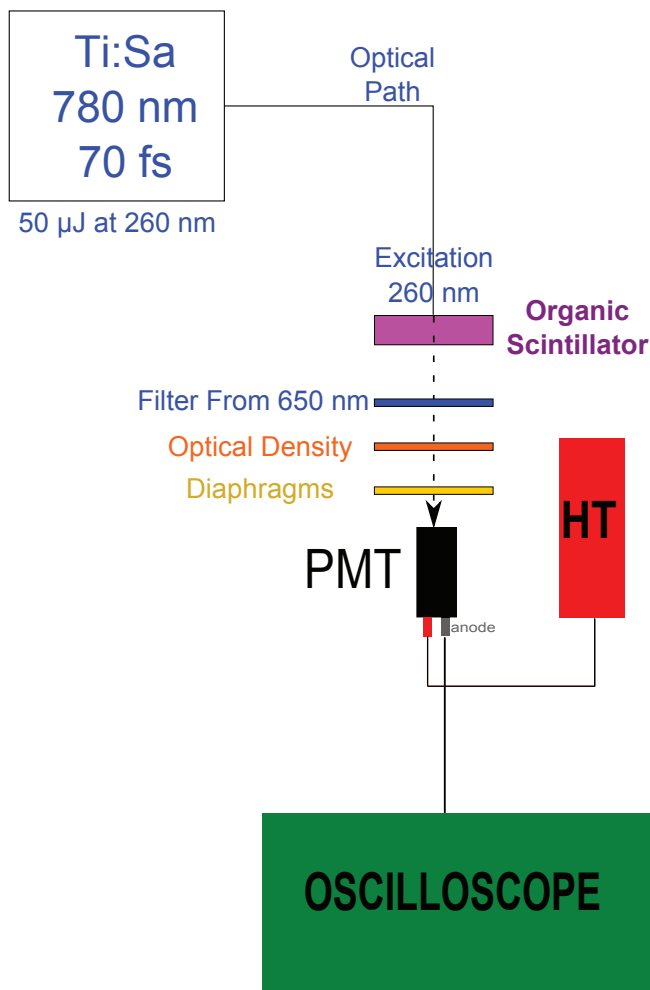

Fig. 14: Experimental set-up of the femtosecond LASER photolysis experiment for photoionisation purposes as an attempt to simulate nuclear interactions.

A. Liquid Organic Scintillator BC-501A with Very High n/γ Discrimination Efficiency

Fig. 15 shows the fluorescence decay obtained after LASER illumination of the BC-501A at 0.2, 2, 5 and 10 μJ with a 2 mm beam diameter and a repetition rate of 100 Hz.

We observe in Fig. 15 that the fluorescence decay increases with the energy of the LASER. From 5 μJ the fluorescence decay increases in time but its shape changes too which is a proof of other than simple fluorescence phenomena occurring suggesting that photoionization is achieved. Further absorption experiments with the same LASER will be devoted to demonstrate that TTA are causing those differences. As the standard deviations are added we can observe that both decays are significantly separated. Quantification of these differences will be performed. A clear correlation between its very high discrimination efficiency and very high TTA rates can be made.

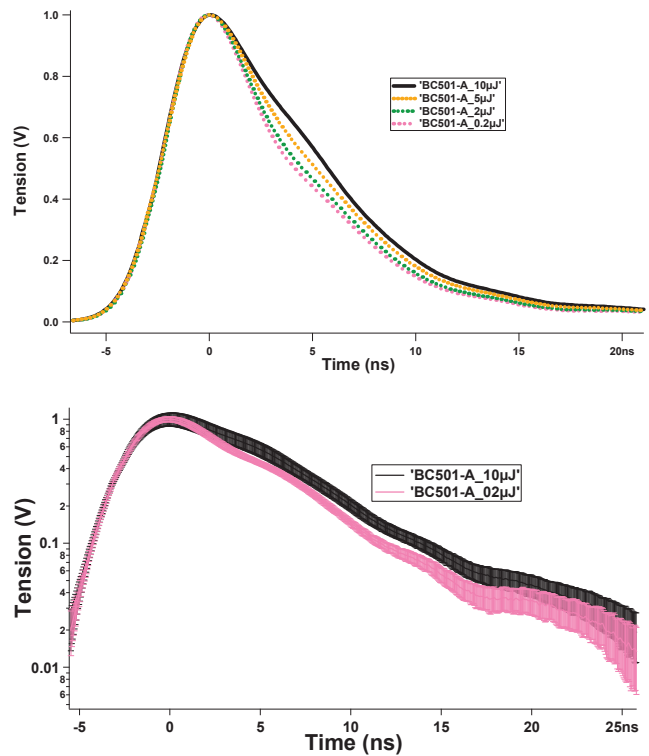

Fig. 15: Fluorescence decay in time of a BC-501A commercial liquid scintillator with highly efficient n/γ discrimination efficiency illuminated at 260 nm by a Ti:Sa LASER at 0.2, 2, 5 and 10 μJ with a diameter beam of 2 mm. The liquid sample is in a 1 mm thick cell in random motion, the repetition rate of the LASER is 100 Hz as we can see upward. 4000 wave forms have been averaged and normalized, and below standard deviations have been added to the two extreme energies decay.

B. Plastic Organic Scintillator EJ-200 with Very Poor n/γ Discrimination Efficiency

Fig. 16 shows the fluorescence decay obtained after LASER illumination of the EJ-200 at 0.2, 2, 5 and 10 μJ at a 2 mm beam diameter and a repetition rate of 100 Hz.

We observe in Fig. 16 that the fluorescence decay is not increased as the energy of the LASER increases. Photoionization may be achieved and T states generated but TTA rates can be negligible. Further transient absorption experiments with the same LASER will be performed to identify excited states induced and their relaxation dynamics. As the standard deviations are added we can observe that both decays are clearly merged. Quantification of these differences will be performed. A clear correlation between its very poor discrimination efficiency and very poor TTA rate can be made.

C. Sample 1 Organic Scintillator with Good n/γ Discrimination Efficiency

Fig. 17 shows the fluorescence decay obtained after LASER illumination of the Sample 1 at 0.2, 10 and 25 μJ with a 4 mm beam diameter and a repetition rate of 1000 Hz. At 25 μJ the signal was not stable and decreased of 50 %, which is

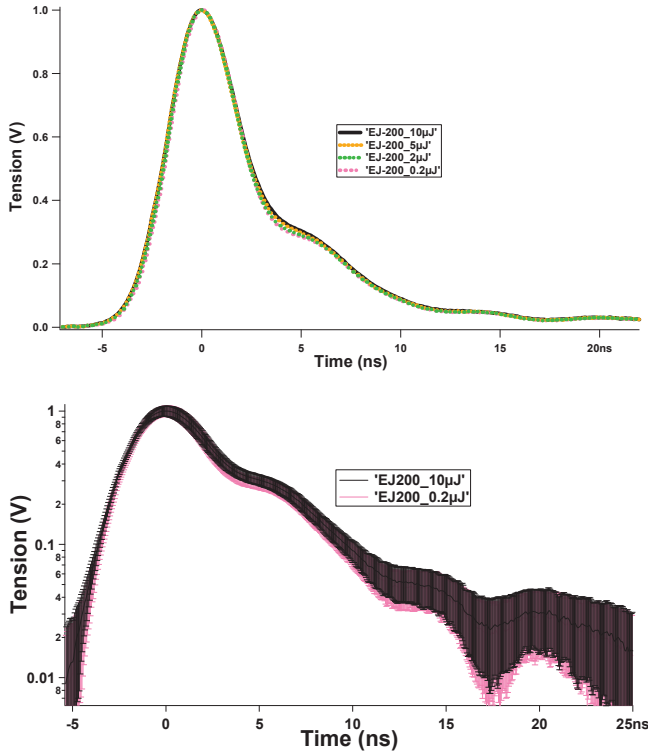

Fig. 16: Fluorescence decay in time of the reference commercial plastic scintillator with inefficient n/γ discrimination efficiency illuminated at 260 nm by a Ti:Sa LASER at 0.2, 2, 5 and 10 μJ for a diameter of 2 mm. The plastic sample is in constant rotation shifted from its center, the repetition rate of the LASER is 100 Hz in the upper part. 2000 wave forms have been averaged and normalized and below standard deviations have been added to the two extreme energies decay.

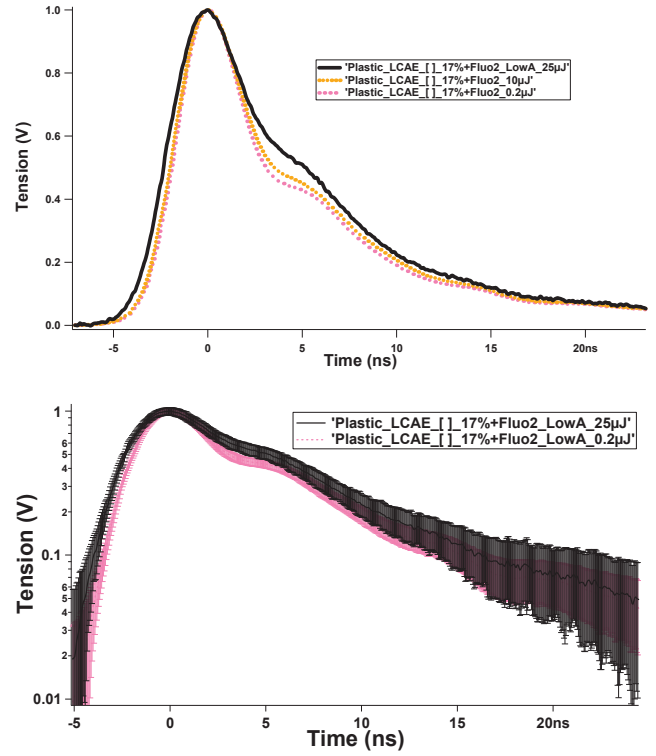

Fig. 17: Fluorescence decay in time of the Sample 1 with efficient n/γ discrimination efficiency illuminated at 260 nm by a Ti:Sa LASER at 0.2, 10 and 25 μJ for a diameter of 4 mm. The plastic sample is in constant rotation shifted from its center, the repetition of the LASER is 100 Hz in the upper part. For energies of 0.2 and 10 μJ , 2000 wave forms and for 25 μJ 229 wave forms have been averaged and normalized. Below standard deviations have been added to the two extreme energies decay.

not related to a deterioration of the sample before stabilization since we have observed that decrease several times in the same sample days apart.

We observe in Fig. 17 that the fluorescence decay increases with the energy of the LASER suggesting that photoionization is achieved from 25 μJ . Further transient absorption experiments with the same LASER will be devoted to demonstrate that TTA are causing those differences specifically by studying the influence first fluorophore concentration. As the standard deviations are added we can observe that both decays are separated. Quantification of these differences will be performed. A clear correlation between its discrimination efficiency abilities and high TTA rates giving rise to a clear increase in time of the fluorescence decay can be made.

VI. CONCLUSION AND PROSPECTS

n/γ discrimination experiments have been investigated in a liquid and plastic scintillators. Optical methods are used as an attempt to simulate nuclear interactions. In a range of plastic and liquid organic scintillators delayed light components have been generated by femtosecond LASER pulses at 260 nm wavelength, demonstrating that energy transfers other than

simple fluorescence occur, suggesting that photoionization was achieved.

Further experiments of transient species absorption in different organic media are going to be performed to identify T states formation and annihilation processes experimentally and prove that it is in fact TTA and come in support to plastic development as an alternative to ^3He replacement. Also comparisons between lifetimes proper to the different molecules in the scintillators will be compared to the decay time of luminescence results to confirm our conclusions. The end goal of this work is to correlate both optical and nuclear experiments to understand n/γ discrimination photophysical processes in organic scintillators. Also as an attempt to validate what have been described in the literature [11] [14].

Previous results have been obtained on some of the same organic materials tested in the present paper with a 5 ns pulsed LASER at intensities up to 30 mJ. The photon flux appeared to be sufficient to produce T excited states [15]. However no delayed luminescence was observed what can be explained by an excited state density insufficient for Triplet-Triplet annihilations (TTA) to occur in these conditions.

Also promising results in the development of organic plastic

that discriminates have been obtained and lead to a patent filed [13]. Further work will consist in optimizing and exploring different compositions, especially first dye concentration contribution, for all studies described.

REFERENCES

- [1] C. Guerrero, D. Cano-Ott, M. Fernández-Ordez, E. González-Romero, T. Martínez, and D. Villamarn, "Analysis of the BC501A neutron detector signals using the true pulse shape," *Nuclear Instruments and Methods in Physics Research Section A: Accelerators, Spectrometers, Detectors and Associated Equipment*, vol. 597, no. 23, pp. 212 – 218, 2008. [Online]. Available: <http://www.sciencedirect.com/science/article/pii/S0168900208014113>
- [2] R. Kouzes, J. Ely, A. Lintereur, and D. Stephens, "Neutron Detector Gamma Insensitivity Criteria," Pacific Northwest National Laboratory (PNNL), Richland, WA (US), Tech. Rep., 2009.
- [3] R. Kouzes, "The ^3He supply problem," Pacific Northwest National Laboratory (PNNL), Richland, WA (US), Tech. Rep., 2009.
- [4] P. Peerani, A. Tomanin, S. Pozzi, J. Dolan, E. Miller, M. Flaska, M. Battaglieri, R. D. Vita, L. Ficini, G. Ottonello, G. Ricco, G. Dermody, and C. Giles, "Testing on novel neutron detectors as alternative to ^3He for security applications," *Nuclear Instruments and Methods in Physics Research Section A: Accelerators, Spectrometers, Detectors and Associated Equipment*, vol. 696, no. 0, pp. 110 – 120, 2012. [Online]. Available: <http://www.sciencedirect.com/science/article/pii/S0168900212007929>
- [5] R. Hansen, P. Reeder, A. Peurrung, and D. Stromswold, "Neutron-gamma discrimination in plastic scintillators," *Nuclear Science, IEEE Transactions on*, vol. 47, no. 6, pp. 2024 –2028, dec 2000.
- [6] J. R. Lakowicz and G. Weber, "Quenching of fluorescence by oxygen. Probe for structural fluctuations in macromolecules," *Biochemistry*, vol. 12, no. 21, pp. 4161–4170, 1973. [Online]. Available: <http://pubs.acs.org/doi/abs/10.1021/bi00745a020>
- [7] F. D. Brooks, R. W. Pringle, and B. L. Funt, "Pulse Shape Discrimination in a Plastic Scintillator," *Nuclear Science, IRE Transactions on*, vol. 7, no. 2-3, pp. 35 –38, june 1960.
- [8] P. L. Feng, J. Villone, K. Hattar, S. Mrowka, B. M. Wong, M. D. Allendorf, and F. P. Doty, "Spectral- and Pulse-Shape Discrimination in Triplet-Harvesting Plastic Scintillators," *Nuclear Science, IEEE Transactions on*, vol. PP, no. 99, p. 1, 2012.
- [9] N. Zaitseva, B. L. Rupert, I. Pawelczak, A. Glenn, H. P. Martinez, L. Carman, M. Faust, N. Cherepy, and S. Payne, "Plastic scintillators with efficient neutron/gamma pulse shape discrimination," *Nuclear Instruments and Methods in Physics Research Section A: Accelerators, Spectrometers, Detectors and Associated Equipment*, vol. 668, no. 0, pp. 88 – 93, 2012. [Online]. Available: <http://www.sciencedirect.com/science/article/pii/S0168900211021395>
- [10] R. Voltz and G. Laustriat, "Radioluminescence des milieux organiques I. étude cinétique," 1968.
- [11] R. Voltz, J. Da Silva, G. Laustriat, and A. Coche, "Influence of the nature of ionizing particles on the specific luminescence of organic scintillators," *The Journal of Chemical Physics*, vol. 45, p. 3306, 1966.
- [12] G. Knoll, "Radiation detection and measurement," 1979.
- [13] M. Hamel, P. Blanc, C. Dehe-Pittance, and S. Normand, Patent FR1 352 072, 2013.
- [14] J. Birks, *The theory and practice of scintillation counting*. Pergamon Press, 1964. [Online]. Available: http://www.amazon.fr/Scintillation-Counters-J-Birks/dp/B0007DX4FS/ref=sr_1?ie=UTF8&sr=8-1
- [15] P. Blanc, M. Hamel, Rocha, and S. L. Normand, "Study and Understanding of Neutron/Gamma Discrimination in Organic Plastic Scintillators," in *IEEE NSS/MIC Conference 2012, Anaheim, 2012*.