



HAL
open science

Radiation effects on type I Fiber Bragg Gratings: influence of recoating and irradiation conditions

Thomas Blanchet, Adriana Morana, Guillaume Laffont, Romain Cotillard,
Emmanuel Marin, Aziz Boukenter, Youcef Ouerdane, Sylvain Girard

► **To cite this version:**

Thomas Blanchet, Adriana Morana, Guillaume Laffont, Romain Cotillard, Emmanuel Marin, et al..
Radiation effects on type I Fiber Bragg Gratings: influence of recoating and irradiation conditions.
Journal of Lightwave Technology, 2018, 36 (4), pp.998 - 1004. 10.1109/JLT.2018.2791640 . cea-01764997

HAL Id: cea-01764997

<https://cea.hal.science/cea-01764997v1>

Submitted on 13 Apr 2023

HAL is a multi-disciplinary open access archive for the deposit and dissemination of scientific research documents, whether they are published or not. The documents may come from teaching and research institutions in France or abroad, or from public or private research centers.

L'archive ouverte pluridisciplinaire **HAL**, est destinée au dépôt et à la diffusion de documents scientifiques de niveau recherche, publiés ou non, émanant des établissements d'enseignement et de recherche français ou étrangers, des laboratoires publics ou privés.

Radiation Effects on Type I Fiber Bragg Gratings: Influence of Recoating and Irradiation Conditions

Thomas Blanchet, *Student Member, IEEE* Adriana Morana, *Member, IEEE*, Guillaume Laffont, Romain Cotillard, Emmanuel Marin, Aziz Boukenter, Youcef Ouerdane, and Sylvain Girard, *Senior Member, IEEE*

Abstract— Fiber Bragg Gratings (FBGs) present strong advantages for temperature or strain sensing in harsh radiation environments even if their properties are affected by radiations. The amplitudes and kinetics of these radiation induced changes depend on numerous parameters, intrinsic or extrinsic to the FBGs themselves. In this paper, we characterized 40 keV X-ray radiation effects on type I FBGs inscribed in pre-hydrogenated SMF-28 from Corning through an ultraviolet laser exposure at 244 nm (cw). We performed a systematic study of the influence of several FBG manufacturing parameters on their radiation response up to 100 kGy(SiO₂) highlighting Radiation-Induced Bragg Wavelength Shifts (RI-BWS) up to 130 pm (~13°C error for temperature measurements) but no decrease of those FBG reflectivity. Among the investigated parameters are the duration and temperature (100°C or 300°C) of the thermal treatments applied post-inscription to stabilize the FBG and to complete the H₂ out-gassing. For such type of FBG, the device has to be recoated after inscription, we then characterize the impact of this manufacturing step on the FBG response, showing that its recoating with NOA-81 acrylate slightly degrades its radiation resistance. In addition to this study, the influence of two other parameters have also been characterized: RI-BWS increases with the dose rate in the range 1 Gy/s to 50 Gy/s and a pre-irradiation at 1.5 MGy does not stabilize type I FBG response to a second irradiation.

Index Terms—Optical Fiber Sensors, Fiber Bragg Grating, Radiation, X-rays, Temperature sensors.

I. INTRODUCTION

Since the last decades, industry has shown an increasing interest for Optical Fiber Sensors (OFSs). Among all the OFS technologies, the Fiber Bragg Grating (FBG) one is the most studied and these devices are currently used to monitor health structures for civil and military applications [1]. FBGs have numerous advantages, such as small size, light weight, ability of multiplexing, fast time-response (kHz interrogation is achieved), and a good tolerance to electromagnetic perturbations. A FBG consists of a periodic modulation of the refractive index in the fiber core, often created by a laser

exposure (ultraviolet (UV) or infrared (IR), continuous wave or femtosecond pulsed...) combined with an interferometric method such as Phase Mask, Lloyd Mirror or through a technique called point-by-point [2]. This modulation causes a narrow dip or peak, in the transmission or reflection spectra respectively, centered at the Bragg wavelength (λ_B), defined by two parameters:

$$\lambda_B = 2 n_{\text{eff}} \Lambda \quad (1)$$

with n_{eff} the effective refractive index and Λ the grating period. When mechanical strain or temperature change is applied to the fiber, λ_B shifts proportionally to the external parameter change. For example, if we focus our attention on FBG based temperature sensing, λ_B shifts linearly between 20°C and 100°C as the following equation:

$$\lambda_B(T) = \lambda_B(T_0) + \alpha (T - T_0) \quad (2)$$

where T_0 is the reference temperature and α the FBG temperature sensitivity coefficient that is around 10 pm/°C for silica-based fibers [3]. This coefficient depends on the fiber composition, its opto-geometry, FBG inscription method, pre- or post-inscription treatments (hydrogenation, annealing, pre/post-irradiation ...) and also on the coating type [2].

The gratings can be separated in mainly two types, according to the inscription conditions [2], [4] and the origin of the grating refractive index modulation. The origin of Type I gratings is defect center generation; indeed, at temperatures higher than 350°C, these defects recombine causing a reduction of the refractive index modulation amplitude, which leads to the grating erasure [4]. When the laser power density is above a threshold, which depends on the fiber composition, type II gratings can be manufactured. They are more resistant to high temperatures, up to 800°C at least, since the index modulation is due to a silica densification for inscription by femtosecond IR-laser [5] or damage at the core-cladding interface for the UV-laser. During the irradiation of the optical fibers, three main macroscopic phenomena can be observed [6]. Radiation Induced Attenuation (RIA) [7] is caused by the generation or conversion of defects inside the silica matrix, due to ionization or knock-on processes. Each of these defects can be associated with one or several absorption bands, which can attenuate

T. Blanchet, A. Morana, E. Marin, A. Boukenter, Y. Ouerdane and S. Girard are with Univ-Lyon, Laboratory Hubert Curien (LabHC), CNRS UMR 5516, 42000 Saint-Etienne, France, phone : (+33)169 085 256; email: thomas.blanchet@cea.fr, sylvain.girard@univ-st-etienne.fr, guillaume.laffont@cea.fr

T. Blanchet, R. Cotillard and G. Laffont are with the French Alternative Energies and Atomic Energy Commission (CEA), LIST, LCAE, 91191 Gif-sur-Yvette, France.

partially or completely the transmitted signal depending on its wavelength. Radiation Induced Emission (RIE) is another effect induced by radiation in amorphous silica. It consists of the emission of light induced by the stimulation by radiation of pre-existing and/or radiation induced defect centers or for certain environments of Cerenkov light [7]. Since the RIE bands are much broader than the Bragg peak width due to amorphous state of the silica, RIE can be neglected when working with FBG operating in the infrared domain. The last effect is the Radiation Induced Compaction (RIC) of the silica matrix [8], [9]. The same basic mechanisms have to be considered when studying the FBG radiation response. RIA of the fiber supporting the FBG should be sufficiently limited to ensure its interrogation. Typically, for Telecom-grade germanosilicate optical fibers, the RIA is in the order of a few hundredths of dB/km at MGy dose level [6], [10] allowing to use tens of meters sensing length or more below these dose levels. RIA and RIC induce changes in the effective refractive index, through the Kramers-Kroning and Lorentz-Lorenz equations, respectively. Radiation can also change the FBG period. The changes in effective refractive index (Δn_{eff}) and in the grating period ($\Delta \Lambda$) cause:

- Radiation-Induced Bragg Wavelength Shift (RI-BWS) [11]:

$$\frac{\Delta \lambda_B}{\lambda_B} = \frac{\Delta n_{eff}}{n_{eff}} + \frac{\Delta \Lambda}{\Lambda} \quad (3)$$

For example, a variation of Δn of 10^{-4} can induce a RI-BWS of 100 pm corresponding to an error of 10°C [1];

- A reduction of the Bragg peak amplitude.

The FBG radiation response depends on the fiber composition [12], the inscription techniques [13], thermal annealing [11] and coating [14]. Radiation hardened fs-based FBGs written in radiation-hardened pure-silica core or fluorine-doped fibers have been manufactured allowing to limit the RI-BWS to a few pm (error below 1°C) at MGy dose level [7]. To investigate the influence of recoating and other manufacturing parameters, the Type I FBG technology was selected for this paper as it is more widely used for harsh environments associated with doses up to 100 kGy. Its manufacturing implies to pre-hydrogenate the fiber in order to increase its photosensitivity. Such grating is also known as more radiation sensitive making easier the study of second-order effects as those investigated here [9]. In this work, we used the germanosilicate SMF-28 from Corning, which was pre-hydrogenated to increase its UV photo-sensitivity. The fiber coating was mechanically striped out on the FBG area and type I gratings were inscribed with a cw UV laser with interferometric method (Lloyd mirror). By changing the mirror angle it is possible to change the interferometric pattern which induces a change on the FBG period. This method allows us to inscribe easily on the same fiber several FBGs with different Bragg wavelengths.

A post-inscription thermal treatment (TT) or thermal annealing was applied to the FBGs, in order first to remove the remaining hydrogen within the fiber and second to thermally stabilize the grating. To the best of our knowledge, only a few studies were performed on the influence of the post-inscription TT on the grating response under radiation. Henschel *et al.* [12] found out that the higher is the TT temperature, the larger is the RI-BWS

for type I FBGs written in Corning SMF28-e under γ -rays. In this previous work, two different TT conditions after inscription were compared: 240°C for 3 min + 100°C during 72 h, and 100°C during 72 h. After 100 kGy(SiO_2) RI-BWSs of 140 pm (error of 14°C) and 80 pm (8°C) have been measured when the grating is subjected to the first or second treatment, respectively.

For the UV laser writing, the fiber coating (usually acrylate for Telecom-grade fibers) has to be removed. This uncoated, or bare, FBG can then be thermally treated at temperatures higher than the ones supported by the acrylate coating (80°C) to ensure its future stability when operating at elevated temperatures. In order to ensure the FBG reliability during the deployment in real facility as nuclear power plant, the uncoated zone is then usually recoated and the coated FBG integrated into the harsh environment without knowing the coating effect on the grating radiation response. For our study, some of the manufactured FBGs were recoated with acrylate and a second TT (post-recoating annealing of 12 h at 50°C) was done to stabilize the coating. Very few studies were dedicated to the contribution of this operation to the FBG radiation responses [14], [15], [16].

Gusarov *et al.* [14] studied the response of type I gratings with different coatings under γ -rays (up to a total dose of 40 kGy(SiO_2)) and Curras *et al.* under proton irradiations (up to an equivalent dose of 30 kGy). Both showed that the RI-BWS of the acrylate-coated FBG is larger than the one of bare gratings but smaller than those of FBGs coated with ormoer and polyimide. The authors suggest that this effect is due to swelling of the coating that changes the stress on the gratings.

Henschel *et al.* [16], [17] compared the gamma-rays induced BWS on gratings, that were uncoated, re-coated and from which the acrylate re-coating was removed. They observed that the re-coated gratings shift less than the uncoated ones, under radiation up to 100 kGy; whereas no difference was observed between the two gratings that underwent to the re-coating process before irradiation, independently of the re-coating presence during the irradiation. So, the authors concluded that the decrease of the radiation-sensitivity of the re-coated gratings was due to the UV curing light.

In this paper, we study the effects of a post-inscription/before recoating TT at different temperatures and of the acrylate recoating of bare type I FBGs on their radiation response under X-rays, up to 100 kGy(SiO_2) at a dose-rate of 5 Gy/s. Moreover, the influences of the dose-rate (1, 5, 10 and 50 Gy/s) and of a pre-irradiation at 1.5 MGy are also investigated.

II. EXPERIMENTAL PROCEDURE

A. FBGs Manufacturing and Treatments

Type I FBGs were written at Laboratoire Hubert Curien (LabHC) in Saint-Etienne, France, on SMF-28 fiber from Corning. The fiber was pre-hydrogenated during one week at Room Temperature (RT) at 150 bars and conserved in a fridge at -25°C , for less than one month, before the grating inscription. Table I shows the annealing or TT, duration to ensure a complete out-gassing of H_2 for a 125 μm diameter fiber, such as the SMF-28, at four different temperatures: -25 , 25, 100 and 300°C . At -25°C , H_2 needs almost 2 years to be entirely removed, whereas at 300°C it takes less than 7 min. Consequently, fibers can stay one month in the fridge at -25°C

and still be highly photosensitive for the FBG inscription. The FBGs were inscribed with an UV-argon (cw) laser at 244 nm with an optical power of 120 mW through the Lloyd mirror technique. Three 5 mm long FBGs were written in each fiber, one near the other. The three FBGs have different Bragg peaks (1548, 1554 and 1559 nm) allowing their simultaneous measurements and to have a better statistic.

In order to study post-inscription/pre-recoating TT effects, two different temperatures were chosen: 100°C and 300°C. The duration of the thermal treatment was fixed in order to stabilize the FBGs with respect to the temperature with the goal to ensure its operation for one week at 80°C, and also to ensure that all the remaining hydrogen will have out-diffused before the radiation tests [18], [19].

TABLE I. COMPLETE OUT-GASSING OF H₂ FOR SMF-28 AT 4 DIFFERENT TEMPERATURES (-25, 25, 100 AND 300°C) [18]

Temperature	-25°C	25°C	100°C	300°C
H ₂ complete out-gassing at 1 bar	640 days	19 days	13.5 h	6.5 min

The durations of the two thermal treatments post-inscription/pre-recoating were fixed at 69 h for 100°C and 17 minutes for 300°C. To study the radiation-effects on the coating, some of the FBGs were recoated with acrylate (NOA-81, from Norland Products Incorporated) thanks to a mini-coater (from Nyfors). The duration of the UV curing is about 45 seconds for a coating length of 3 cm and the temperature increases up to 50°C. Moreover, to stabilize the coating, a post-recoating TT was performed at 50°C for 12 h (according to the datasheet of the NAO-81). During this second TT, no shift of λ_B was detected. Table II reports all the TT done on the gratings before irradiation.

TABLE II. MAIN CHARACTERISTICS OF TYPE I FBGs STABILIZED TO OPERATE AT 80°C FOR 1 WEEK.

FBGs	FBG 100°C	FBG 100°C Co	FBG 300°C	FBG 300°C Co
H ₂ loading	Yes	Yes	Yes	Yes
Post Inscription/Pre-recoating thermal treatment (TT)	100°C 69 h	100°C 69 h	300°C 17 min	300°C 17 min
Re-Coating post TT	None	Yes	None	Yes
Post-recoating TT	None	12 h 50°C	None	12 h 50°C

B. FBGs Irradiation Test Procedure

The FBGs were irradiated at the MOPERIX facility in LabHC up to the accumulated dose of 100 kGy at RT. The X-rays generator is manufactured by COMET AG and used a Tungsten target. With a voltage of 100 kV, the photon mean energy is ~40 keV. In the entire article, the dose is expressed in Gy(SiO₂).

Different dose-rates were used: 1, 5, 10 and 50 Gy/s. As shown in Figure 1, the FBGs were fixed on an Aluminium pad, without any stress, thanks to few brides on only one side of the gratings. Two thermocouples were used to detect the small temperature fluctuations (less than 5°C) during the irradiation run.

In order to isolate only the radiation-induced contribution to the BWS, the contribution linked to the temperature fluctuations have been corrected in the following radiation test data by considering a temperature coefficient of 10 pm/°C. This value has been measured by recording the grating peak position after the thermal treatment. The gratings reflection spectra were recorded by a National Instrument PMA-1115 devices, which has a resolution of 4 pm at a frequency of 10 Hz.

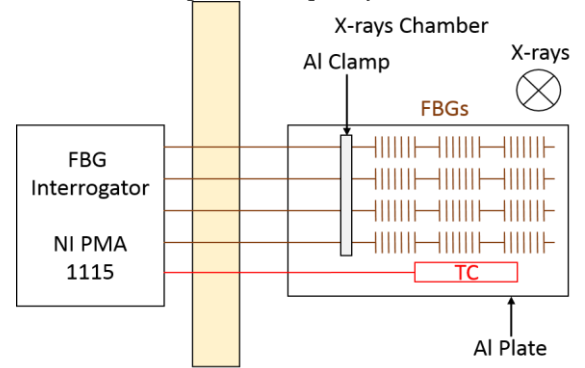

Figure 1. Experimental setup used for the X-ray irradiations: four fibers containing each three FBGs (identical inscription conditions – 3 different λ_B) are fixed without stress on an Aluminium pad, with clamps and exposed to X-rays up to 100 kGy. Thermocouples (TC) measured the temperature evolution during irradiation.

III. RESULTS & DISCUSSION

A. Influence of the Thermal Treatments before re-coating

In this section, we study the radiation effects on bare gratings that underwent different post-inscription/pre-recoating thermal treatments. We will focus our attention on the RI-BWS since variations of less than 5% were recorded on the peak amplitude for all the considered FBGs. Figure 2 shows the RI-BWS measured for the 3 FBGs at 1548, 1554 and 1559 nm on a unique fiber and the average of the three curves. All the three FBGs were exposed to a post-inscription TT of 100°C during 69 h. During the irradiation, λ_B shifts toward the red and, after 100 kGy, a shift of about 100 pm is recorded: this RI-BWS corresponds to an error of 10°C, if the FBGs were used as temperature sensors. After irradiation, a small recovery of 10 pm after 2 hours was observed. We can observe a weak data dispersion (less than 5%) for the three gratings, written with the same conditions and subjected to the same thermal treatment. Similar dispersion is observed for all the other FBG sets, consequently for the next figures only the average response of the three FBGs is discussed.

Figure 3 highlights the effects of various TTs on the grating radiation-response. When a grating is subjected to a post inscription TT at 100°C but lasting only 17 min, the RI-BWS at 100 kGy dose is 70 pm, which is less than the 100 pm detected when the TT at 100°C lasted for 69 h. As a consequence, for an annealing at 100°C, the longer the TT duration, the larger the RI-BWS. It has to be noticed that the grating treated at 100°C during 17 min had no more hydrogen inside, since all the gratings were conserved during several weeks at ambient atmosphere before the irradiation tests.

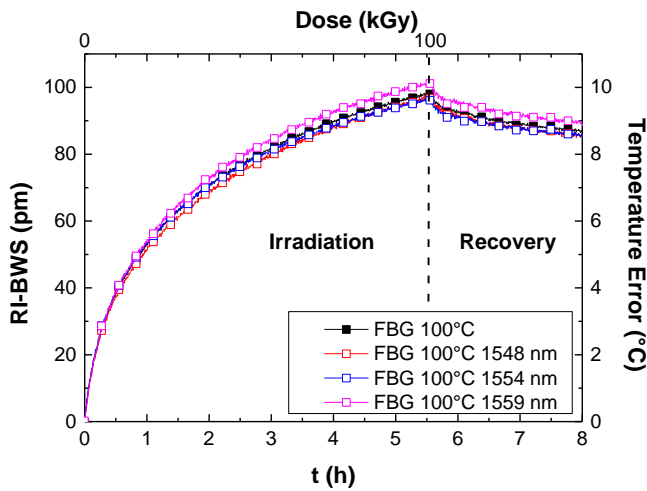

Figure 2: RI-BWS of a line of 3 FBGs ($\lambda_B=1548$ nm; 1554 nm and 1559 nm) thermally treated at 100°C for 69 h after inscription during and after X-ray irradiation up to 100 kGy (5 Gy/s). On the right Y-axis the radiation induced error on the FBG temperature measurements is given.

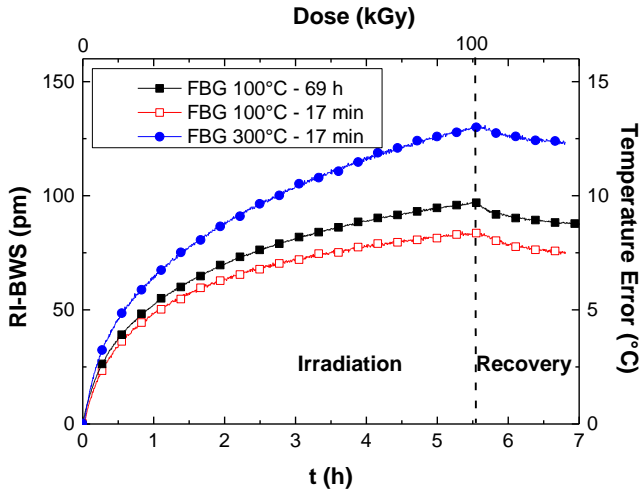

Figure 3: RI-BWS of 3 FBGs submitted to various post-inscription thermal treatments: 100°C (69 h), 100°C (17 min) and 300°C (17 min) during and after X-ray irradiation up to 100 kGy (5 Gy/s). On the right Y-axis the radiation induced error on the FBG temperature measurements is given.

Finally, the third FBG of Fig. 3 was submitted to a TT at 300°C for 17 min and it shows a RI-BWS at 100 kGy dose of 125 pm. Therefore, for annealing temperature up to 300°C, when two gratings are subjected to TT of the same duration but at different temperatures, the higher is the TT temperature, the larger is the RI-BWS. In our case, the shift increases from 70 pm to 125 pm, for gratings annealed at 100°C and 300°C for 17 min, respectively, in agreement with observations made by Henschel *et al.* [12].

The effective refractive index of Type I gratings is based on the creation of defects by UV light in the intense fringe of the interference pattern. During the TT, a part of these defects are annealed, reducing n_{eff} and consequently the grating refractivity and the Bragg wavelength values. The longer the TT duration or the higher its temperature, the more defects will recombine, restoring their precursors [20]. More precursors will be present

just before irradiation leading to more radiation-induced defects [21], resulting in a larger Δn_{eff} and consequently a larger RI-BWS.

B. Influence of pre-irradiation before recoating

Since pre-irradiation can sometimes enhance the FBGs radiation hardness, as it was shown for fs-FBGs [22], we irradiated at RT a bare grating annealed at 100°C (for 69 h) up to 1.5 MGy dose twice, at a dose rate of 5 Gy/s. The results are shown in Figure 4. During the first 1.5 MGy run, the grating peak red-shifts of 135 pm. During the 10 days lasting recovery at RT, the Bragg wavelength does not stabilize. During the second 1.5 MGy run, reaching 3 MGy, the pre-irradiated FBG λ_B quickly reaches the same RI-BWS of the first irradiation: ~135 pm. The relative RI-BWS, compared to the λ_B value obtained just before the second irradiation start, is only about 30 pm. During the second recovery at RT, after 10 days, the FBG peak does not reach yet a stabilized value. The pre-irradiation treatment does not permit to stabilize this type of grating.

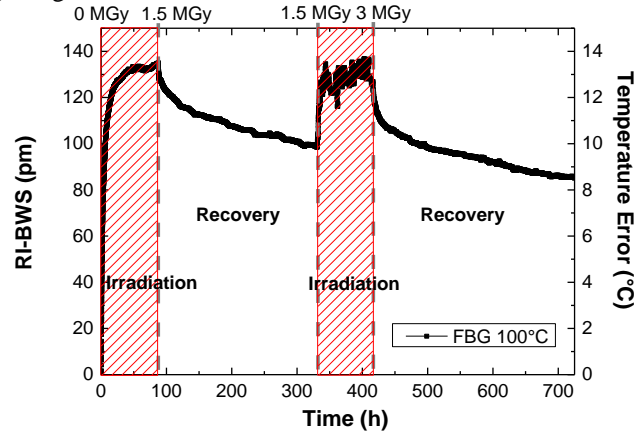

Figure 4: RI-BWS of a bare FBG annealed at 100°C (69 h) for an accumulated dose of 3 MGy obtained through two irradiation runs at RT of 1.5 MGy (5 Gy/s) each, separated by 10 days of recovery at RT.

C. Dose rate effects

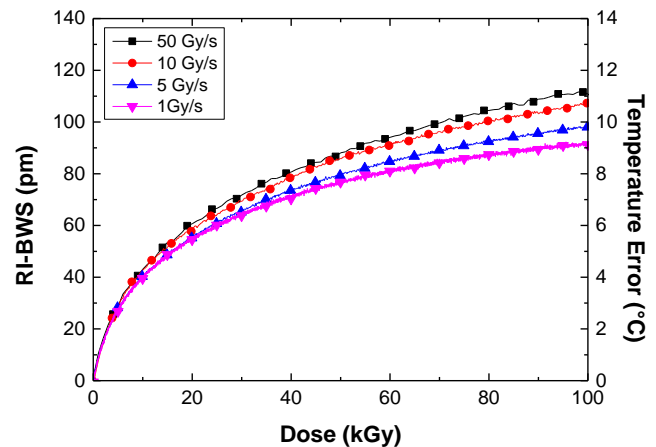

Figure 5: Irradiation of 4 identical bare FBGs annealed at 100°C during 69h, up to a total dose of 100 kGy at 4 different dose-rates: 1, 5, 10 and 50 Gy/s.

The influence of the dose-rate on RI-BWS is of primary importance to evaluate the vulnerability of a FBG for a given profile of use in harsh environments but has only been investigated in a limited number of papers [23], [24]. Figure 5 shows the effects of X-rays on four identical FBGs annealed at 100°C during 69 h and irradiated at four different dose-rates (1, 5, 10 and 50 Gy/s) up to the same dose of 100 kGy. In agreement with literature [23], for Type I FBGs by increasing the dose-rate, the RI-BWS increases. This phenomenon is explained by the competition during irradiation of defect creation and bleaching. Lowering the dose rate favors the annealing effect, resulting in lower RI-BWS [1].

D. Influence of recoating

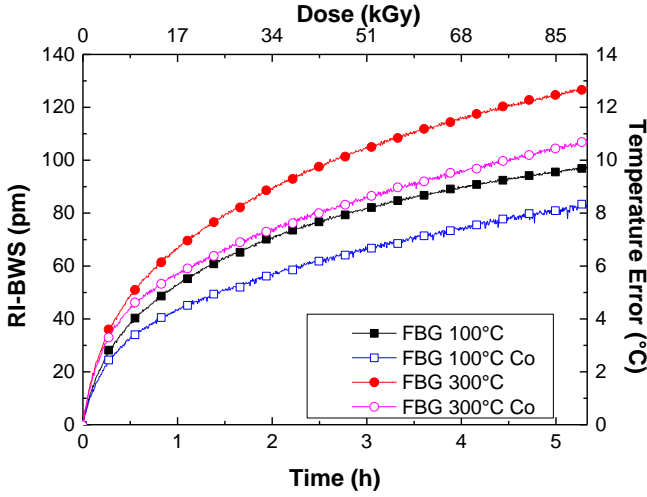

Figure 6. RI-BWS of 4 FBGs submitted to various post-inscription thermal treatments: 100°C (69 h) and 300°C (17 min), with or without recoating, during X-ray irradiation up to 100 kGy (5 Gy/s).

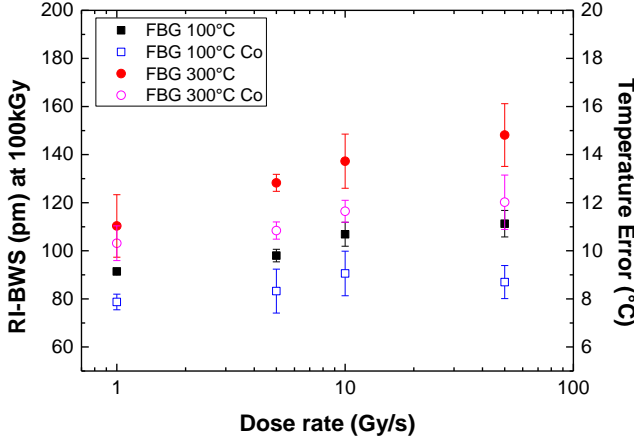

Figure 7. RI-BWS at 100 kGy of FBGs that underwent different thermal treatments at 100°C and 300°C without and with coating at 4 dose-rates: 1, 5, 10 and 50 Gy/s. The relative error was calculated with the statistics on the three identical FBGs written along the same fiber and subjected to the same treatments.

The response of four gratings subjected to post-inscription/pre-recoating thermal treatments (at 100 and 300°C) with and without coating are given in Figure 6 for an X-ray irradiation up to 100 kGy at 5 Gy/s dose-rate.

At the irradiation end the bare FBG has a RI-BWS of ~100 pm for a TT of 100°C and ~130 pm for a TT of 300°C. For the coated gratings, the RI-BWS at 100 kGy is ~80 pm for an annealing at 100°C and ~110 pm for 300°C.

Coated FBGs are more radiation resistant than their equivalent bare ones within the studied conditions, such as fiber composition, type I grating, post inscription thermal treatment and coating material. As it can be seen in Figure 7, the dose-rate influence on the FBG responses depends on the pre-coating annealing and on the coating presence. First, as it was already observed, the FBGs at 300°C show larger RI-BWS than the ones at 100°C. Second, the coated FBGs are more radiation resistant than the bare ones, for the same dose. Third, the higher the dose-rate the larger the RI-BWS, except for the coated grating pre-annealed at 100°C the BWS induced at the highest dose-rate is comparable with that induced at 10 Gy/s.

E. Acrylate coating shielding effects

Our results highlight different behaviors between bare and coated optical fibers: the RI-BWS is larger for bare FBGs than for the coated ones. A first possible hypothesis is that the acrylate coating could shield the fiber from 40 keV X-rays and that the measured effect is an artefact due to the used radiation source.

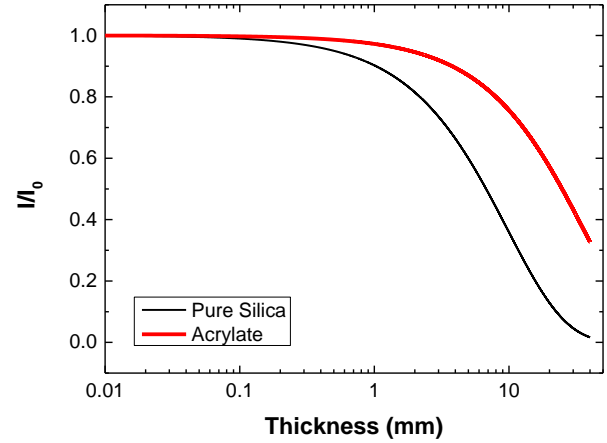

Figure 8. Attenuation of X-rays (40 keV) as a function of the thickness of silica or acrylate material.

The absorption of radiation from a material is defined as [25], [26]:

$$\frac{I}{I_0} = e^{-\frac{\mu}{\rho} \rho t} \quad (4)$$

where I is the intensity after a thickness t , I_0 is the incident intensity, μ/ρ is the mass attenuation coefficient and ρ the density. Figure 8 illustrates this ratio for 40 keV X-rays attenuation for different thicknesses of pure amorphous silica and acrylate. For 125 μm thickness of pure silica, the diameter of a classical fiber, only 2% of the X-rays are absorbed; whereas for acrylate less than 1% of X-rays are absorbed. Therefore, our acrylate coating, whose thickness is typically 62.5 μm , provides no shielding to the FBG. Therefore, this hypothesis can be eliminated.

F. UV curing light effects

Another hypothesis is the influence of the UV-light during the polymerization process as discussed in [16]. The gratings were subjected to different numbers of polymerization cycles (up to 3) with and without acrylate coating in order to discriminate the effects of UV light and stress due to the coating. Each polymerization cycle consists of a treatment with the UV light of the mini coater and lasts only 45 seconds. The polymerization without coating is the worst case, because in this configuration, the acrylate will not reduce the UV light intensity reaching the fiber. As for the previous experiments, all the FBGs, coated and uncoated, were subjected to two TTs: a pre-recoating annealing at 100°C (69h) and 50°C (12h) post-recoating annealing. Then they were irradiated at 5 Gy/s up to 100 kGy.

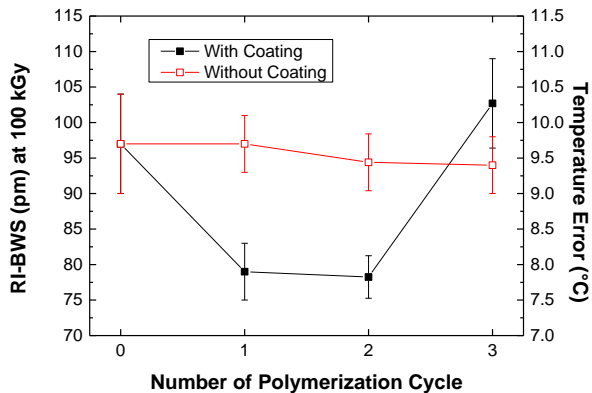

Figure 9. BWS induced at 100 kGy for different FBGs that underwent to different polymerization cycles (0 to 3) with (full black square) and without coating (empty red square). To obtain this graph at least 4 gratings were studied for each irradiation condition.

The FBGs without coating are not affected by the UV-light of the recoating process, within the measurement error, for a number of cycle up to at least 3, as shown in figure 9. On the contrary, the response of the coated FBGs depends on the number of polymerization cycles. There is no difference between 1 or 2 polymerization cycles, whereas for the coated gratings subjected to three cycles the RI-BWS returns to the value obtained for the uncoated gratings within the experimental uncertainties. However, *Henschel et al.* [16], [17] studied the effects of the coating on type I FBGs inscribed in SMF-28e fiber (with H₂ loading) with a KrF laser (248nm). Two thermal treatments were effectuated on their gratings (240°C during 3 min and 100°C during 72h). The recoating process was performed between the two annealings. These authors investigated three different conditions: uncoated and acrylate recoated FBGs and gratings that underwent the recoating process but their coating was removed before the irradiation. The authors observed no difference between the responses under radiation of FBGs that were subjected to acrylate recoating (removed or not before the irradiation tests). Instead, the uncoated gratings shifted less than the recoated ones. So, they concluded that these effects are due to the UV curing of the acrylate coating during the polymerization. In our case, the observed difference between the responses of coated and uncoated gratings cannot be due to the curing

process, as highlighted in Figure 9. This difference with the results of *Henschel et al.* [16] may be due to different UV lamp powers used during polymerization.

G. Internal stress effects

Another possibility explaining our results is that radiation affects the coating properties, as observed in [27], through e.g. a further X-rays induced polymerization which can change the fiber internal stress and consequently induces an additional shift of the Bragg peak. The study of *Gusarov et al.* [14], [28] on several types of coatings, including acrylate, under γ -rays led to the opposite results than ours. The authors observed a larger RI-BWS for the coated FBGs than for the bare ones: at 40 kGy, the RI-BWS was 15 pm for an uncoated grating, 20 pm for acrylate coating, 25 pm for polyimide and 45 pm for ormoecer recoated FBGs. They concluded that RI-BWS of recoated FBG is induced by the stress variation induced by the coating on the gratings.

To confirm these results further experiments with the other types of acrylate available commercially are needed. Those acrylate coatings withstand temperature up to 100°C implying to characterize additional coating technologies such as polyimide or metallic recoating for applications at higher temperatures. From our results and those of *Gusarov et al.* [14], we can suggest that the recoating impact on the grating radiation response will depend on both the type of coating and on its deposition conditions.

IV. CONCLUSIONS

Our study led to three main conclusions. The first one is about the effects of the post-inscription/pre-recoating thermal treatments on the radiation response. For example we demonstrated that two annealings at 100°C and 300°C which give rise to the same thermal stability at 80°C cause different responses under irradiation. Indeed, the higher is its temperature, the larger is the RI-BWS observed under X-rays on type I FBGs, up to 100 kGy (dose rates from 1 to 50 Gy/s).

The second concerns the influence of a FBG pre-irradiation on its response to a second irradiation: a pre-irradiation of 1.5 MGy on a bare type I FBG reduces the BWS induced during the irradiation but the peak does not stabilize after the irradiation, probably because of processes of defect recombination which take place at the irradiation end. It is then not possible for this FBG technology to use pre-irradiation as a radiation hardening technique.

The third conclusion is about the effect of the acrylate recoating of the FBG on its response under radiation. The recoating influences the FBG response, improving it in our test conditions. We have demonstrated that the acrylate coating cannot shield the grating against X-rays. Furthermore, the polymerization process cannot explained the Bragg wavelength shift under X-rays too. The only remaining hypothesis is that the coating achieves its polymerization under irradiation, as suggested by *Gusarov et al.* [14] and that this phenomenon affects the fiber internal stress that in turn affects the FBG performances. This effect can be mitigated by performing three polymerization cycles to stabilize the coating allowing to obtain recoated FBGs with the same performances than the bare ones. It is worth to note that the radiation impact on the coating

(positive or negative) will depend on its nature and its deposition procedure. Before qualification of FBG-based sensors for operation into harsh environments, clear radiation hardness assurance tests will have to be defined and followed to establish the expected FBG degradation. Finally, for type I, cw UV FBG the higher is the dose-rate, the larger is the observed RI-BWS during irradiation. However, we showed that a coupled recoating / dose rate dependence of the RI-BWS exists.

REFERENCES

- [1] A. Gusarov and S. K. Hoeffgen, 'Radiation Effects on Fiber Gratings', *IEEE Trans. Nucl. Sci.*, vol. 60, no. 3, pp. 2037–2053, Jun. 2013.
- [2] J. Canning, 'Fibre gratings and devices for sensors and lasers', *Laser Photonics Rev.*, vol. 2, no. 4, pp. 275–289, Aug. 2008.
- [3] K. O. Hill and G. Meltz, 'Fiber Bragg grating technology fundamentals and overview', *J. Light. Technol.*, vol. 15, no. 8, pp. 1263–1276, 1997.
- [4] C. W. Smelser, S. J. Mihailov, and D. Grobncic, 'Formation of Type I-IR and Type II-IR gratings with an ultrafast IR laser and a phase mask', *Opt. Express*, vol. 13, no. 14, pp. 5377–5386, 2005.
- [5] A. Morana *et al.*, 'Radiation Vulnerability of Fiber Bragg Gratings in Harsh Environments', *J. Light. Technol.*, vol. 33, no. 12, pp. 2646–2651, Jun. 2015.
- [6] S. Girard *et al.*, 'Radiation Effects on Silica-Based Optical Fibers: Recent Advances and Future Challenges', *IEEE Trans. Nucl. Sci.*, vol. 60, no. 3, pp. 2015–2036, Jun. 2013.
- [7] D. Di Francesca *et al.*, 'X-ray irradiation effects on fluorine-doped germanosilicate optical fibers', *Opt. Mater. Express*, vol. 4, no. 8, p. 1683, Aug. 2014.
- [8] W. Primak, 'Fast-neutron-induced changes in quartz and vitreous silica', *Phys. Rev.*, vol. 110, no. 6, p. 1240, 1958.
- [9] L. Remy, G. Cheymol, A. Gusarov, A. Morana, E. Marin, and S. Girard, 'Compaction in Optical Fibres and Fibre Bragg Gratings Under Nuclear Reactor High Neutron and Gamma Fluence', *IEEE Trans. Nucl. Sci.*, vol. 63, no. 4, pp. 2317–2322, Aug. 2016.
- [10] S. Rizzolo *et al.*, 'Radiation effects on optical frequency domain reflectometry fiber-based sensor', *Opt. Lett.*, vol. 40, no. 20, pp. 4571–4574, Oct. 2015.
- [11] A. Morana *et al.*, 'Radiation tolerant fiber Bragg gratings for high temperature monitoring at MGy dose levels', *Opt. Lett.*, vol. 39, no. 18, p. 5313, Sep. 2014.
- [12] H. Henschel, S. K. Hoeffgen, K. Krebber, J. Kuhnenn, and U. Weinand, 'Influence of Fiber Composition and Grating Fabrication on the Radiation Sensitivity of Fiber Bragg Gratings', *IEEE Trans. Nucl. Sci.*, vol. 55, no. 4, pp. 2235–2242, Aug. 2008.
- [13] A. Morana *et al.*, 'Influence of photo-inscription conditions on the radiation-response of fiber Bragg gratings', *Opt. Express*, vol. 23, no. 7, p. 8659, Apr. 2015.
- [14] A. Gusarov, C. Chojetzki, I. Mckenzie, H. Thienpont, and F. Berghmans, 'Effect of the Fiber Coating on the Radiation Sensitivity of Type I FBGs', *IEEE Photonics Technol. Lett.*, vol. 20, no. 21, pp. 1802–1804, Nov. 2008.
- [15] E. Curras *et al.*, 'Influence of the Fiber Coating Type on the Strain Response of Proton-Irradiated Fiber Bragg Gratings', *IEEE Trans. Nucl. Sci.*, vol. 59, no. 4, pp. 937–942, Aug. 2012.
- [16] H. Henschel, S. K. Hoeffgen, J. Kuhnenn, and U. Weinand, 'Influence of Manufacturing Parameters and Temperature on the Radiation Sensitivity of Fiber Bragg Gratings', *IEEE Trans. Nucl. Sci.*, vol. 57, no. 4, pp. 2029–2034, Aug. 2010.
- [17] K. Krebber, H. Henschel, and U. Weinand, 'Fibre Bragg gratings as high dose radiation sensors?', *Meas. Sci. Technol.*, vol. 17, no. 5, pp. 1095–1102, May 2006.
- [18] T. Erdogan, V. Mizrahi, P. J. Lemaire, and D. Monroe, 'Decay of UV-induced fiber Bragg gratings', *OSA/OFC*, 1994.
- [19] S. R. Baker, H. N. Rourke, V. Baker, and D. Goodchild, 'Thermal decay of fiber Bragg gratings written in boron and germanium codoped silica fiber', *J. Light. Technol.*, vol. 15, no. 8, pp. 1470–1477, 1997.
- [20] M. Lancry and B. Poumellec, 'UV laser processing and multiphoton absorption processes in optical telecommunication fiber materials', *Phys. Rep.*, vol. 523, no. 4, pp. 207–229, Feb. 2013.
- [21] M. Leon *et al.*, 'Neutron Irradiation Effects on the Structural Properties of KU1, KS-4V and I301 Silica Glasses', *IEEE Trans. Nucl. Sci.*, vol. 61, no. 4, pp. 1522–1530, Aug. 2014.
- [22] A. Morana, 'Gamma-rays and neutrons effects on optical fibers and Bragg gratings for temperature sensors', PhD Thesis, Université Jean Monnet de Saint Etienne (France) and Università Degli Studi di Palermo (Italy), 2013.
- [23] A. Fernandez Fernandez, B. Brichard, F. Berghmans, and M. Décreton, 'Dose-rate dependencies in gamma-irradiated fiber Bragg grating filters', *IEEE Trans. Nucl. Sci.*, vol. 49, no. 6, pp. 2874–2878, Dec. 2002.
- [24] A. Morana *et al.*, 'Dose Rate Effect Comparison on the Radiation Response of Type I Fiber Bragg Gratings Written With UV cw Laser', *IEEE Trans. Nucl. Sci.*, vol. 63, no. 4, 2016.
- [25] S. M. Seltzer, 'Calculation of Photon Mass Energy-Transfer and Mass Energy-Absorption Coefficients', *Radiat. Res.*, vol. 136, no. 2, pp. 147–170, Nov. 1993.
- [26] J. H. Hubbel and S. M. Seltzer, 'X-Ray Mass Attenuation Coefficients', *National Institute of Standards and Technology: Physical Measurement Laboratory*, Jul-2004. [Online]. Available: <https://www.nist.gov/pml/x-ray-mass-attenuation-coefficients>.
- [27] S. Rizzolo *et al.*, 'Radiation Characterization of Optical Frequency Domain Reflectometry Fiber-Based Distributed Sensors', *IEEE Trans. Nucl. Sci.*, vol. 63, no. 3, pp. 1688–1693, Jun. 2016.
- [28] A. Gusarov, C. Chojetzki, I. Mckenzie, and F. Berghmans, 'Influence of the coating type on the radiation sensitivity of FBGs', *Opt. Sens. 2008 SPIE Proc*, vol. 7003, pp. 1–6, Apr. 2008.