



HAL
open science

Application of Distributed Model Predictive Approaches to Temperature and CO_2 Concentration Control in Buildings

Shalika S. W. Walker, Warody Lombardi, Suzanne Leseq, Samira Roshany-Yamchi

► To cite this version:

Shalika S. W. Walker, Warody Lombardi, Suzanne Leseq, Samira Roshany-Yamchi. Application of Distributed Model Predictive Approaches to Temperature and CO_2 Concentration Control in Buildings. IFAC world Congress 2017, Jul 2017, Toulouse, France. cea-01564058

HAL Id: cea-01564058

<https://cea.hal.science/cea-01564058>

Submitted on 18 Jul 2017

HAL is a multi-disciplinary open access archive for the deposit and dissemination of scientific research documents, whether they are published or not. The documents may come from teaching and research institutions in France or abroad, or from public or private research centers.

L'archive ouverte pluridisciplinaire **HAL**, est destinée au dépôt et à la diffusion de documents scientifiques de niveau recherche, publiés ou non, émanant des établissements d'enseignement et de recherche français ou étrangers, des laboratoires publics ou privés.

Application of Distributed Model Predictive Approaches to Temperature and CO_2 Concentration Control in Buildings^{*}

Shalika S.W. Walker^{*} Warody Lombardi^{**} Suzanne Lesecq^{**}
Samira Roshany-Yamchi^{***}

^{*} Eindhoven University of Technology, Dpt of the Built Environment
5600 MB, Eindhoven, The Netherlands (e-mail: S.W.Walker@tue.nl)

^{**} Univ. Grenoble Alpes, CEA, LETI, Minatec Campus

F-38054 Grenoble, France (e-mail: FirstName.LastName@cea.fr)

^{***} NIMBUS Centre for Embedded Systems Research

Cork Institute of Technology, Cork, Ireland

(e-mail: samira.roshany@cit.ie)

Abstract: In the context of energy consumption reduction, this paper focuses on the application of Model Predictive Control to occupants' thermal comfort together with indoor air quality control while improving the whole building energy efficiency. First, an open-space office split in three zones, located in Cork Institute of Technology, is modeled. A centralized MPC is designed to control the temperature and CO_2 concentration in the three zones. Then, a distributed version of the MPC, with three separate local controllers, is considered. Finally, simulation results show that the distributed MPC solution achieves control performance quite close to the centralized version with less computing effort.

Keywords: Model Predictive Control, centralized, distributed, RC model, Energy management, temperature, CO_2 concentration.

1. INTRODUCTION

Buildings consume more than 40% of the total primary energy resources throughout the world [Shaikh et al. (2014), Cigler (2013)]. Moreover, inefficiencies of the deployed sensing and control strategies cause energy waste that should be avoided by a better coordination among Building Automation Systems (BMS) and appropriate control approaches. The minimization of the energy consumed by buildings is essential for their sustainability. However, this minimization may badly affect the occupants' comfort, e.g. by reducing (resp. increasing) the temperature in the building when the outside temperature is low (resp. high). Basically, a higher degree of indoor comfort is expected by the occupants along with the increased time they spend inside buildings. While performing their daily activities in buildings, energy savings should not negatively impact occupants' health or decrease their welfare [Castilla and et al. (2013)], thus leading to contradictory objectives [Wang et al. (2014)] at control level. Energy and Comfort Management Systems try to fulfill occupants' comfort expectations while reducing energy consumption.

Indoor Environmental Quality (IEQ) is related to thermal aspects [Sarbu and Sebarchievici (2013)], Indoor Air Quality (IAQ), acoustic and visual (lighting) levels [Castilla and et al. (2013)], while humidity level also affects the

comfort feeling. IEQ/IAQ is an active research area, from clinical and medical viewpoints, to control, but also building construction and retrofit, communication, etc. These research works are often related to energy efficiency and HVAC control. IAQ regulations are regularly reinforced (e.g. French statutory-orders n2011-1728 (air quality in public buildings) and n2011-1727 (benzene, formaldehyde and CO_2 levels)) while building energy efficiency is encouraged *via* directives, e.g. [Union (2010)]. This situation advocates for more multi-disciplinary researches to better optimize buildings, taking into account occupants' comfort and advanced control of BMS [Shaikh et al. (2014)].

Air quality, either indoor or outdoor, is one of the major health concerns [Gurjar and et al. (2010)]. Moreover, quality of the indoor environment has strong health impact because of the close structure of the buildings. Indoor air pollutants are mostly emitted from sources inside the buildings but they can also enter from outside. CO_2 is usually considered the main IAQ indicator. Indoor CO_2 is mainly produced by the occupants exhalation. Poor indoor air quality can lead for the occupants to suffer from Sick Building Syndrome and building related illnesses. Thermal comfort is defined as "*the condition of mind which expresses satisfaction with the thermal environment*" in the international regulations ISO-7730 and ASHRAE-55 [ASHRAE (1992)]. Therefore, it is related to conscious intellectual activity influenced by the physical, psychological and physiological factors of the occupants.

^{*} This work is supported by TOPAS H2020 project, GA nb 676760 (<https://www.topas-eeb.eu/>). This work has been performed while S. Walker and W. Lombardi were resp. internship and research-engineer in CEA-LETI.

Buildings have been equipped with BMS to manage the various systems installed, from lighting, ventilation, heating, but also fire alarm, and security. When properly tuned, they can offer better energy efficiency for the building, for instance by switching off the light when nobody is in a given area. With the integration of actuator/sensor networks, these systems can monitor and control the interior conditions so as to fulfill IEQ while keeping the energy consumption at a minimum. Unfortunately, this ideal situation is seldom reality because of the contradictory influence of building energy efficiency and occupants' comfort on the energy bill. Thus, building controllers should take into account multiple objectives, or at least, take a Multi-Input Multi-Output (MIMO) viewpoint to deal with such constrained systems.

The present paper presents an application of Model Predictive Control (MPC) to deal with thermal and CO_2 concentration control in indoor environment. Temperature T and CO_2 concentration are contradictory by nature. Basically, the CO_2 concentration can be easily decreased by the injection of fresh outdoor air inside the building using for instance forced or natural ventilation. The side effect of this injection is the decrease of the indoor temperature when the outdoor one is colder, leading to more heating. Both aspects are physically coupled and can be modeled using a MIMO model. The proposed controller is applied to an open-space office, split in three zones, and located in Cork Institute of Technology (CIT), Ireland. A centralized MPC approach is first designed. It requires all data to be collected in a unique control point. For large buildings, and in presence of communication issues, this can lead to bad functioning of the control law. Thus, a distributed version of the controller, with loosely coupled areas, might be of interest to overcome these situations. Such a distributed approach is therefore proposed. This Distributed MPC implements a separate local controller for each zone.

The rest of the paper is organized as follows. Section 2 recalls basics and notations for MPC. Section 3 presents the control-oriented thermal model developed here for the setup considered. Sections 4 and 5 are dedicated to the design of the centralized and distributed MPC approaches. Section 6 shows some simulation results and discusses implementation cost. A conclusion gives future work directions.

2. BASICS ON MODEL PREDICTIVE CONTROL

As a control methodology, Model Predictive Control (MPC) can naturally deal with MIMO systems subject to physical constraints. The control law is computed in real-time and on-line *via* the solution of an optimization problem. Contradictory objectives, e.g. building energy efficiency and occupants' comfort, can be simultaneously considered.

2.1 Summary of MPC for Building Management

MPC has gained popularity among researchers and industry in various engineering fields as an effective approach to deal with multi-variable constrained control problems. In the building sector, MPC is used for building climate

control, cooling, heating, ventilation, etc. The main aim of MPC when applied to building management is to reduce the energy consumption, taking into account occupants' comfort expectation [Cigler (2013)]. MPC design is traditionally a three-step process [Camacho and Alba (2013)]:

- (1) **Modeling of the system.** The efficiency and accuracy of the control actions highly depend on the system model. This latter is expressed with a state-space representation, which for a Linear Time Invariant (LTI) model is given by:

$$\begin{aligned} x(k+1) &= Ax(k) + Bu(k) \\ y(k) &= Cx(k) \end{aligned} \quad (1)$$

where $y(k) \in \mathbb{R}^m$ is the measurement (output), $x(k) \in \mathbb{R}^n$ is the system state and the control (input) vector is u . Matrices A, B, C are real of appropriate dimension.

- (2) **Cost objective function.** Here, the cost function is chosen to minimize the energy consumption and ensure IEQ. Energy consumption and IEQ must be satisfied under constraints on the system outputs and inputs. In the present context, the square of the control vector u is related to energy flow. Therefore, minimizing u^2 is equivalent to the energy consumption minimization. This can be achieved through the minimization of the cost function:

$$J = \sum_{j=1}^N \left\{ \underbrace{\|(y - y_{ref})(k+j)\|_Q^2}_{\text{Comfort}} + \underbrace{\|\Delta u(k+j)\|_R^2}_{\text{Energy}} \right\} \quad (2)$$

under the constraints

$$\begin{cases} \text{Eq.(1)} \\ y_{min} \leq y \leq y_{max}, u_{min} \leq u \leq u_{max} \\ \Delta u_{min} \leq \Delta u \leq \Delta u_{max} \end{cases}$$

where $\Delta u(k) = u(k) - u(k-1)$. y_{ref} is the comfort level (temperature and CO_2 concentration) that should be maintained. $Q > 0$ and $R > 0$ are weighting matrices. The first part of the cost function is related to the comfort objective while the second part deals with the energy consumption. Note that the Δ formulation implies the usage of an integrator.

- (3) **Prediction horizon N and weighting matrices Q, R .** These tuning parameters influence the closed loop response time, and the relative weight of both objectives, namely comfort and energy efficiency.

2.2 MPC architectures

Three main Model Predictive Control architectures can be found in the literature, namely Centralized MPC, Decentralized MPC and Distributed MPC [Christofides et al. (2013), Scattolini (2009)]. Here, the centralized version is used as reference while the distributed one is considered so as to reduce the computational and communication burdens of the centralized version. Basically, the distributed MPC implements local controllers with smaller size optimization problems to be solved. The centralized and distributed versions are sum up as follows:

- **Centralized MPC (CMPC).** MPC is classically implemented in a centralized scheme where all the control signals are computed using a single objective function. When the system becomes more complex

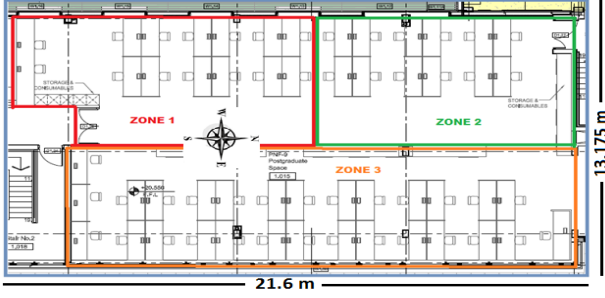

Fig. 1. Selected space of the building divided into 3 zones

and spatially distributed, CMPC requires a significant amount of computing time and data transfer, leading to communication overhead. In case of communication breakdown, the controller is no more able to compute the control signals. As a consequence, for large (scale) systems, as buildings may be, it is highly advisable to divide the system into several (possibly loosely coupled) subsystems.

- **Distributed MPC (DMPC).** In this control architecture, the system is divided into subsystems. Each one has its own local controller that optimizes its own objective function. Information from other subsystems is exchanged between local controllers to achieve better performances. Here, partially connected subsystems are considered. Information about the state in each local system is transmitted to the neighboring local controllers, once in every sampling period [Rawlings and Stewart (2008), Farina and Scattolini (2012), Farina and Scattolini (2011)].

3. BUILDING MODELING FOR MPC

MPC requires a model of the controlled system to predict the system behavior, as briefly recalled in section 2. In this paper, the building thermal behavior is described using an equivalent Resistance-Capacitance (RC) network. The RC parameters are calculated using basic knowledge of the building geometry and construction materials. Mass balance for the CO_2 concentration is used to model air quality. Both models are merged in a state-space model that will be used in the MPC formulation.

3.1 Description of the Experimental Building

The practical study is conducted on a two-storey building from CIT, Ireland. Figure 1 shows the area under study, located at the first floor. This area is divided into three zones that are not separated by walls. Moreover, the BMS installed controls the space under study with three separate units. Hereafter, only the model for zone $z1$ is presented, the models for the other zones being deduced straightforwardly.

3.2 Thermal Model

From the heat transfer and heat storage equations, and applying the equivalent thermal Resistance-Capacitance (RC) model, zone $z1$ is modeled for temperature control. Beside these equations, there is also an effect of the ventilation and of the occupants on the temperature rate

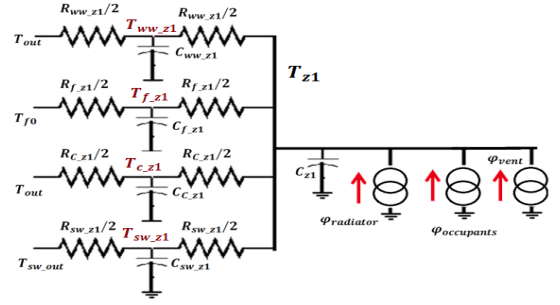

Fig. 2. Equivalent RC model for zone $z1$

of change inside the space. Here, only natural ventilation is used. All these aspects are included in the RC model. The resulting equivalent RC model is given in figure 2 [Široký et al. (2011), Nagy and Sauter (2015)]. The thermal model $z1$ is obtained *via* nodal analysis of the equivalent RC circuit, following the approach in [Maasoumy Haghighi (2011)]. Consider the assumptions hereafter:

- the air in each zone has a unique temperature across its whole volume (lumped model);
- the specific heat of the air c_p is constant and equal to $1.005 K J/kg.K$;
- the radiative coupling between the inner walls of the building is ignored since the temperature differences between the walls are negligible;
- the metabolic heat gain per occupant is $100W$.

The rate of change of temperature T_{z1} in $z1$ is given by:

$$C_{z1} \frac{dT_{z1}}{dt} = \frac{T_{ww,z1} - T_{z1}}{R_{ww,z1/2}} A_{ww,z1} + \frac{T_{sw,z1} - T_{z1}}{R_{sw,z1/2}} A_{sw,z1} + \frac{T_{f,z1} - T_{z1}}{R_{f,z1/2}} A_{f,z1} + \frac{T_{c,z1} - T_{z1}}{R_{c,z1/2}} A_{c,z1} + \varphi + \frac{T_{r,z1} - T_{z1}}{R_{r,z1}} A_{r,z1} + \varepsilon \sigma A_{r,z1} (T_{r,z1}^4 - T_{z1}^4) + Q_{z1} \cdot c_p \cdot (T_{out} - T_{z1}) \quad (3)$$

where φ is the heat flux. C_{z1} is the thermal capacitance. ww is the west wall, sw the south wall, f the floor, and c the ceiling. $R_{a,z1}$, $T_{a,z1}$ and $A_{a,z1}$ are respectively the thermal resistance, temperature and area related to the zone limit $a \in \{r, c, f, sw, ww\}$. Q_{z1} is the ventilation rate in $z1$. In the sequel, denote $f_1 = dT_{z1}/dt$. Similarly to (3), $f_a = dT_{a,z1}/dt$, $a \in \{r, c, f, sw, ww\}$ are defined. Due to lack of space, they are not reported here. Define:

$$f_{z1} = [f_1, f_r, f_c, f_f, f_{sw}, f_{ww}]^T \quad (4)$$

Moreover, the dynamic thermal equations reflect the absence of wall between zones by adding a natural convective heat transfer term (not reported here).

3.3 Air Quality Model

The mass balance for the CO_2 concentration in $z1$ is:

$$g_1 = \frac{dCO_{2,z1}(t)}{dt} = (G(t) * n_{o,z1} + Q_{z1} \{CO_{2,out}(t) - CO_{2,z1}(t)\}) / V_{z1} \quad (5)$$

where $G(t)$ represents the CO_2 generated per person [Emmerich and Persily (2003)] in $z1$, $n_{o,z1}$ is the number of occupants in $z1$ and V_{z1} is the total volume of $z1$. Note that the diffusion between zones that are not separated

by walls is added using the Fick's law to obtain a more realistic mass balance equation (not reported here).

3.4 Model Linearization

The state-space representation is obtained *via* the linearization of the non linear dynamic equations using the Jacobian linearization around an equilibrium point.

Thermal Model Linearization Define the state vector for the thermal model in $z1$ as:

$$x_{T,z1} = [T_{z1} T_{r,z1} T_{c,z1} T_{f,z1} T_{sw,z1} T_{ww,z1}]^T \quad (6)$$

From (4), the state matrix for $z1$ is given by:

$$A_{T,z1} = \left[\frac{\partial f_{z1}}{\partial x_{T,z1}} \right] \quad (7)$$

The experimental building uses natural ventilation only. The control variable is

$$u_{T,z1} = [N_{z1} P_{z1}]^T \quad (8)$$

where N_{z1} corresponds to the windows opened. For simplicity, $N_{z1} = \sum_{w=1}^{n_o} N_{z1,j}$ where n_o is the number of windows opened. $N_{z1,j} \in [0,1]$ is the window j position where 0 (resp. 1) means "window j is closed (resp. fully open)". $P_{z1} \in [0, P_{z1,max}]$ is the power consumption of the heaters. The natural ventilation rate for a single sided ventilation system can be computed with:

$$Q = 0.025 \cdot W_S \cdot A_w \cdot N_{w1} \quad (9)$$

where A_w is the effective area of a window, N_{w1} is the number of windows in $z1$ and W_S is the wind speed. Then:

$$B_{T,z1} = \left[\frac{\partial f_{z1}}{\partial u_{T,z1}} \right] \quad (10)$$

Air Quality Model Linearization Define the state and control vectors for the air quality model:

$$x_{CO_2,z1} = [CO_{2,z1}] \quad u_{CO_2,z1} = [N_{z1}] \quad (11)$$

From (5), it comes:

$$A_{CO_2,z1} = \left[\frac{\partial g_1}{\partial x_{CO_2,z1}} \right] \quad B_{CO_2,z1} = \left[\frac{\partial g_1}{\partial u_{CO_2,z1}} \right] \quad (12)$$

3.5 Linearized model for $z1$

From (6), (8) and (11), it comes:

$$x_{z1} = [x_{T,z1}^T \ x_{CO_2,z1}]^T \quad u_{z1} = [N_{z1} \ P_{z1}]^T \quad (13)$$

The state and control matrices are derived from (7), (10) and (12):

$$A_{z1} = \begin{bmatrix} A_{T,z1} & 0 \\ 0 & A_{CO_2,z1} \end{bmatrix} \quad B_{z1} = \begin{bmatrix} A_{T,z1} \\ B_{CO_2,z1} \end{bmatrix} \quad (14)$$

4. CENTRALISED MPC

The whole system under study is modeled with a state space representation derived from section 3:

$$\begin{aligned} x(k+1) &= Ax(k) + Bu(k) \\ y(k) &= Cx(k) \end{aligned} \quad (15)$$

where

$$x = [x_{z1}^T \ x_{z2}^T \ x_{z3}^T]^T \quad u = [u_{z1}^T \ u_{z2}^T \ u_{z3}^T]^T \quad (16)$$

and

$$A = \begin{bmatrix} A_{z1} & A_{12} & A_{13} \\ A_{21} & A_{z2} & A_{23} \\ A_{31} & A_{32} & A_{z3} \end{bmatrix} \quad B = \begin{bmatrix} B_{z1} & 0 & 0 \\ 0 & B_{z2} & 0 \\ 0 & 0 & B_{z3} \end{bmatrix} \quad (17)$$

A_{ij} , $i \neq j$, accounts for the coupling between zones i and j . Matrix C is defined according to the measured outputs:

$$y = [T_{z1} \ CO_{2,z1} \ T_{z2} \ CO_{2,z2} \ T_{z3} \ CO_{2,z3}]^T \quad (18)$$

Since the state vector x cannot be fully measured, a Luenberger observer has been designed in order to estimate the different temperatures in the three zones.

First, a centralized Model Predictive Controller is designed. The three zones are controlled thanks to the minimization of a unique cost function:

$$\min_{\Delta u(k)} J = \min_{\Delta u(k)} \sum_{j=1}^N \left\{ \underbrace{\|y - y_{ref}\|_Q^2}_{\text{Comfort}} + \underbrace{\|\Delta u(k)\|_R^2}_{\text{Energy}} \right\} \quad (19)$$

$$\text{subject to } \begin{cases} Eq.(15) \\ y_{min} \leq y \leq y_{max}, \quad u_{min} \leq u \leq u_{max} \\ \Delta u_{min} \leq \Delta u \leq \Delta u_{max} \end{cases} \quad (20)$$

where $\Delta u(k) = u(k) - u(k-1)$. y_{ref} contains the comfort references that should be maintained, with thermal and CO_2 parts for each zone:

$$y_{T,ref} = 20^\circ C, \quad y_{CO_2,ref} = 800ppm \quad (21)$$

$Q > 0$ and $R > 0$ are weighting diagonal matrices. Depending on the numerical value of their elements, one can emphasize more on the energy consumption minimization or on the thermal comfort and/or on the air quality comfort. Their choice is not discussed in the paper.

5. DISTRIBUTED MPC

An independent, non-iterative partially connected topology is considered for the distributed control scheme. Therefore, only neighboring controllers communicate. For each zone i , $i = 1 : 3$, a separate controller is designed. The state-space model is defined by:

$$x_i(k+1) = A_{ii}x_i(k) + B_{ii}u_i(k) + \sum_{j \neq i} A_{ij}x_j(k) \quad (22)$$

$$y_i = Cx_i(k) \quad (23)$$

where $x_i = x_{zi}$ is the state vector defined similarly to (13). The output vector is given by:

$$y_i = [T_{zi} \ CO_{2,zi}]^T \quad (24)$$

from which matrix C can be derived straightforwardly. The state and control matrices are given by:

$$A_i = A_{zi} \quad B_i = B_{zi} \quad (25)$$

A_{ij} in 22 models the coupling of neighboring zones i and j . As a consequence, all the zones in the considered space do not (necessarily) appear in (22). Each zone is controlled thanks to the minimization of a dedicated cost function:

$$\min_{\Delta u_i(k)} J_i = \min_{\Delta u_i(k)} \sum_{j=1}^N \left\{ \underbrace{\|y_i - y_{i,ref}\|_{Q_i}^2}_{\text{Comfort}} + \underbrace{\|\Delta u_i(k)\|_{R_i}^2}_{\text{Energy}} \right\} \quad (26)$$

$$\text{subject to } \begin{cases} Eq. (22, 23) \\ y_{i,min} \leq y_i \leq y_{i,max}, \quad u_{i,min} \leq u \leq u_{i,max} \\ \Delta u_{i,min} \leq \Delta u_i \leq \Delta u_{i,max} \end{cases}$$

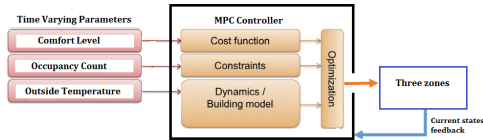

Fig. 3. Simulation setup

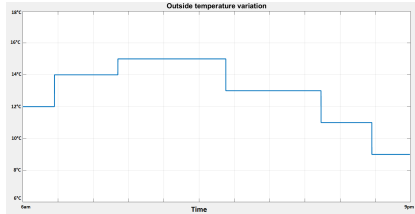

Fig. 4. Outdoor temperature variation

where $\Delta u_i(k) = u_i(k) - u_i(k-1)$. As in the centralized version, the reference $y_{i,ref}$ is given by:

$$y_{i,ref} = [20^\circ C \quad 800ppm]^T \quad (27)$$

$Q_i > 0$ and $R_i > 0$ are defined per zone, in a similar way as for the centralized version of section 4.

6. SIMULATION RESULTS

Both MPC strategies are now validated. The first validation step is performed in simulation using Matlab 2015b. Figure 3 illustrates the simulation environment. Here, the control of the ventilation system relies on the monitoring of CO_2 concentration in each zone. This latter is estimated from occupancy count during the time period [6am, 9pm], see Figure 6 where it appears in orange. The numerical values have been extracted from real-life occupancy count in the open-space office considered. The comfort level for CO_2 concentration is fixed at 800 ppm. Thermal comfort is evaluated with the comparison of the indoor temperature in each zone with a reference one equal to $20^\circ C$. Only heating of the zones is considered along with natural ventilation. The outdoor temperature variation is also considered (see Fig. 4). It is extracted from real-life measurements. The wind speed is supposed constant at 5 m/s, which is the average wind speed in Cork area, Ireland, where the experimental building is located.

6.1 Centralized MPC for thermal and CO_2 comfort regulation

Figure 5 shows simulation results for the temperature variation in the three zones with the centralized MPC approach from section 4. The indoor temperature is controlled nearly as expected, with a maximum error of $2^\circ C$. Note that the temperature constraints in (20) have been set to $\pm 1^\circ C$ around the reference temperature. When more people enter the controlled space, temperature exceeding appears because of extra heating provided by these people, and that cannot be not anticipated. Moreover, outdoor temperature also provides extra heating. This phenomenon can be decreased at the cost of extra energy consumption for the ventilation that will help extract this extra heat.

Figure 6 shows the CO_2 concentration in the 3 zones together with the occupancy count and CO_2 concentration

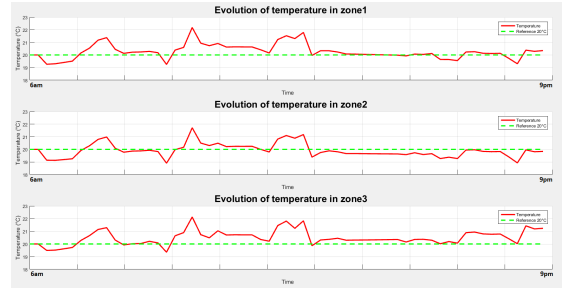

Fig. 5. Indoor temperature in the three zones, Centralized MPC

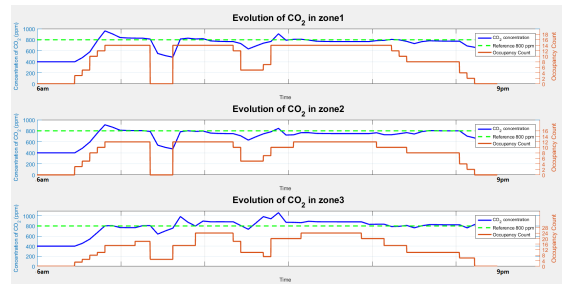

Fig. 6. Indoor CO_2 concentration in the three zones, Centralized MPC

reference. As can be seen, the controller performs as expected, with the CO_2 concentration following the reference despite disturbances introduced by the occupants. Note that the constraints on CO_2 are set to $\pm 100ppm$ around the reference CO_2 concentration.

6.2 Distributed MPC for thermal and CO_2 concentration regulation and comparison with the centralized scheme

The same scenario (i.e. external temperature and wind speed, occupancy count, references) is considered for Distributed MPC evaluation. Figures 7 and 8 show the evolution of the temperature and CO_2 concentration in the three zones.

Results of both control schemes are reported on these graphs for comparison purpose. As can be seen, they provide close results, with slight under performance for the distributed version. However, this latter presents some nice features. First, it does not require the collection of all the information in a unique controller, decreasing therefore the communication burden, especially when large buildings are considered. Moreover, the distributed scheme is less sensitive to communication breakdown as it processes information locally (the coupling with neighboring zones can be temporarily neglected). Second, the distributed version obviously requires less computational capabilities for each individual controller.

6.3 Comparison of energy consumption and computational effort for centralized and distributed schemes

The total energy consumption for the conventional control (i.e. on/off switch of the actuators) and for both MPC strategies is reported in table 6.3. As expected, the energy gain, when compared to the conventional control is slightly smaller for the distributed scheme.

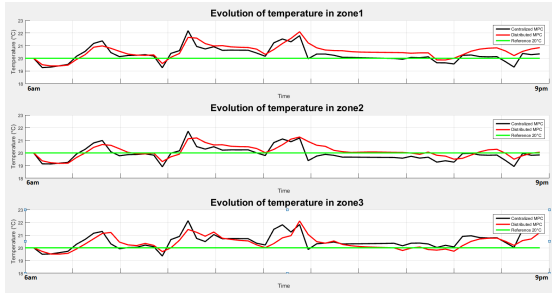

Fig. 7. Indoor temperature in the three zones, centralized (black) and distributed (red) control schemes

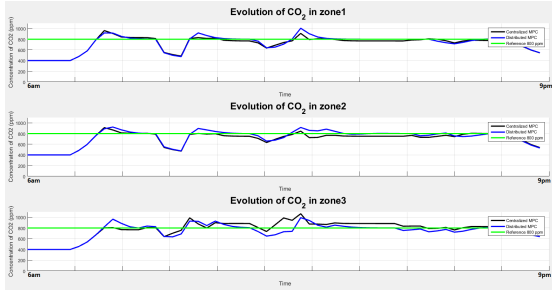

Fig. 8. Indoor CO_2 concentration in the three zones, centralized (black) and distributed (red) control schemes

Table 1. Energy consump. vs. control strategy

Energy (kWh)	Conventional	Centralised	Distributed
Total	181	127.83	138.59
Gain	0 %	30 %	23.5 %

Table 2. Computational cost comparison

	Pb. size	Nb. constraints	Computational time (normalized)
Centralised	21	660	4.7
Distributed	7	220	1

Table 6.3 gives an estimate of the computing effort. There results have been obtained using Matlab 2015b. The distributed MPC is taken as reference. Even if these results might be optimized, the computation involved by the centralized controller, when compared to one controller of the distributed scheme, is clearly more demanding, both in terms of memory and computational burden.

7. CONCLUSION

This paper presents the application of Model Predictive Control to cope with energy efficiency and occupants' thermal and CO_2 concentration comfort in buildings. An open-space office split in three zones, located in Cork Institute of Technology, Ireland, is considered as experimental setup. This space is first modeled. Then, Centralized and Distributed Model Predictive Controllers are designed. Simulation results show that the distributed MPC solution achieves control performance close to the centralized version with less computing effort and communication burden. Both approaches are currently under implementation on the real testbed in the context of the H2020 TOPAs project. Real-life results will be reported during the oral presentation.

REFERENCES

- ASHRAE (1992). *ASHRAE STANDARD: An American Standard: Thermal Environmental Conditions for Human Occupancy*. American Society of Heating refrigeration and air conditioning engineers.
- Camacho, E.F. and Alba, C.B. (2013). *Model predictive control*. Springer Science & Business Media.
- Castilla, M. and et al. (2013). A multivariable nonlinear mpc control strategy for thermal comfort and indoor-air quality. In *IEEE IECON Conf.*
- Christofides, P.D., Scattolini, R., de la Peña, D.M., and Liu, J. (2013). Distributed model predictive control: A tutorial review and future research directions. *Computers & Chemical Engineering*, 51, 21–41.
- Cigler, J. (2013). *Model Predictive Control for Buildings*. Ph.D. thesis, Czech Technical University in Prague.
- Emmerich, S.J. and Persily, A.K. (2003). *State-of-the-art review of CO_2 demand controlled ventilation technology and application*. Diane Publishing.
- Farina, M. and Scattolini, R. (2011). Distributed non-cooperative mpc with neighbor-to-neighbor communication. In *18th IFAC World Congress*.
- Farina, M. and Scattolini, R. (2012). Distributed predictive control: a non-cooperative algorithm with neighbor-to-neighbor communication for linear systems. *Automatica*, 48(6), 1088–1096.
- Gurjar, B.R. and et al. (2010). *Air pollution: health and environmental impacts*. CRC Press.
- Maasoumy Haghghi, M. (2011). *Modeling and Optimal Control Algorithm Design for HVAC Systems in Energy Efficient Buildings*. Master's thesis, EECS Department, University of California, Berkeley.
- Nagy, A. and Sauter, T. (2015). Low complexity room thermal models for energy optimization in industrial buildings. In *IEEE 20th Conf. on Emerging Technologies & Factory Automation (ETFA)*.
- Rawlings, J. and Stewart, B. (2008). Coordinating multiple optimization-based controllers: New opportunities and challenges. *J. of process control*, 18(9), 839–845.
- Sarbu, I. and Sebarchievici, C. (2013). Aspects of indoor environmental quality assessment in buildings. *Energy and Buildings*.
- Scattolini, R. (2009). Architectures for distributed and hierarchical model predictive control—a review. *Journal of Process Control*, 19(5), 723–731.
- Shaikh, P.H., Nor, N.B.M., Nallagownden, P., Elamvazuthi, I., and Ibrahim, T. (2014). A review on optimized control systems for building energy and comfort management of smart sustainable buildings. *Renewable and Sustainable Energy Reviews*, 34, 409–429.
- Široký, J., Oldewurtel, F., Cigler, J., and Prívára, S. (2011). Experimental analysis of model predictive control for an energy efficient building heating system. *Applied Energy*, 88(9), 3079–3087.
- Union, E. (2010). Directive 2010/31/eu of the european parliament and of the council of 19 may 2010 on the energy performance of buildings. Technical report, Strasbourg: Official Journal Eu Communities.
- Wang, N., Fang, F., and Feng, M. (2014). Multi-objective optimal analysis of comfort and energy management for intelligent buildings. In *26th Chinese Control and Decision Conference (CCDC)*.