



HAL
open science

PROJECT FULLFLEX: A MULTIFUNCTIONAL FLEXIBLE ELECTRONIC LABEL

Jean-Christophe P. Gabriel

► **To cite this version:**

Jean-Christophe P. Gabriel. PROJECT FULLFLEX: A MULTIFUNCTIONAL FLEXIBLE ELECTRONIC LABEL. Printed and Flexible Electronics Congress 2017, Feb 2017, Londres, United Kingdom. cea-01555781

HAL Id: cea-01555781

<https://cea.hal.science/cea-01555781>

Submitted on 4 Jul 2017

HAL is a multi-disciplinary open access archive for the deposit and dissemination of scientific research documents, whether they are published or not. The documents may come from teaching and research institutions in France or abroad, or from public or private research centers.

L'archive ouverte pluridisciplinaire **HAL**, est destinée au dépôt et à la diffusion de documents scientifiques de niveau recherche, publiés ou non, émanant des établissements d'enseignement et de recherche français ou étrangers, des laboratoires publics ou privés.

Printed and Flexible Electronics Congress 2017

21st-22nd Feb 2017

London, UK

London Heathrow Marriott Hotel

Abstract: We will present a CEA joint effort that delivered a multifunctional label prototype that integrates flexibles: (i) photovoltaic cells; (ii) a nanoparticle based Li-battery; (iii) a battery management system; (iv) a tension regulator; (v) a temperature sensor; (vi) a light sensor; (vii) a silver nanowire based transparent capacitive touch sensor; (viii) four LEDs; (ix) an electronic motherboard integrating a micro-controller.

Jean-Christophe P. Gabriel

CEA/DRE/DPNS

Jean-Christophe.gabriel@cea.fr

DE LA RECHERCHE À L'INDUSTRIE



www.cea.fr

All this presentation is the property of CEA.
Copyright CEA, all rights reserved, cannot be used without CEA's consent



PROJECT FULLFLEX:

A MULTIFUNCTIONAL FLEXIBLE ELECTRONIC LABEL

Dr. Jean-Christophe P. Gabriel
Dep. Director Nanoscience & **ChimTronic**
Programs

Printed & Flexible Electronics Congress

February 21st, 2017

CEA Key Figures (2015)



CAN A LOT BE DONE FROM NEW PARADIGMS? THE EXAMPLE OF CNTS

- 2001-2007 @ Nanomix (nano.com): CNT integration – Chemical sensors

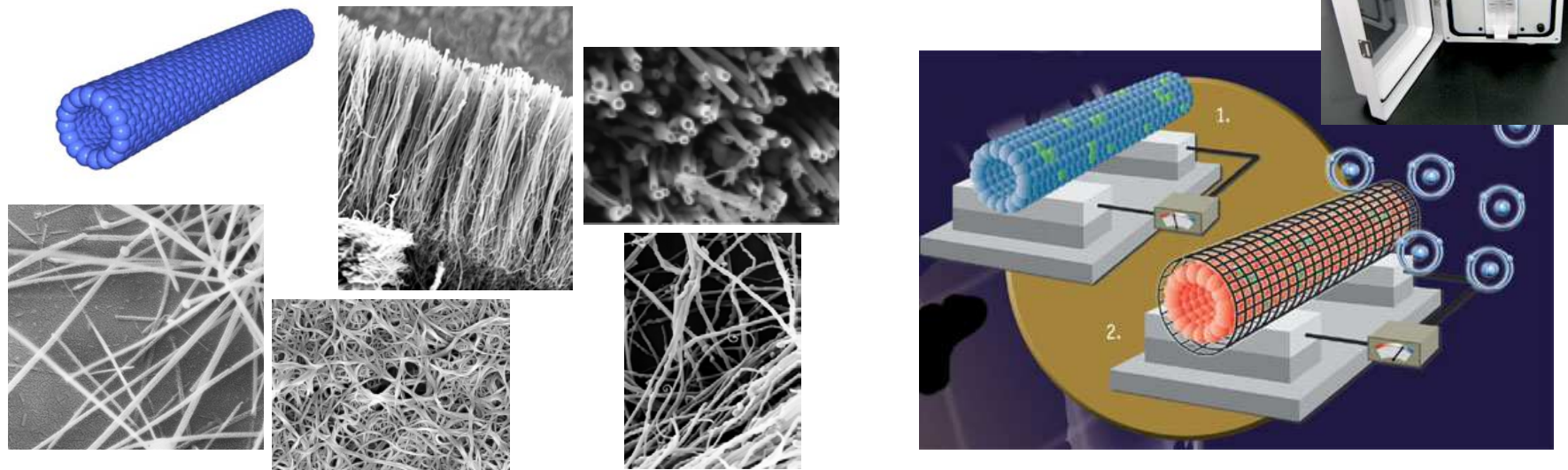

Molecular Wires for Molecular Sensing

- First commercial sensors in 2005: H₂ sensor on Si wafers
- Printed NT sensors deployed in West Africa during Ebola crisis in 2015.
- \$36M raised over 15 years!!!

Nature 413, 504-508, 2001, *Phys. Rev. Lett.* 91(21) 218301, 2003, *Adv. Mater.*, 16(22) 2049-2052, 2004, *J. Phys. Chem. B.* 110(42); 21014-21020, 2006; *Proc. Nat. Acad. Sciences* 103(4), 921-926, 2006, . *J. Phys. Chem. B.* 110(42); 21014-21020, 2006; C. R. Physique, 11(5-6), 362-374, 2010; *Appl. Phys. Lett.* 103, 051907, 2013 + ~50 patent applications
Copyright CEA, all rights reserved

- Leverage effect (period 2008-2013, 98 projects, budget 7M€) : **170%**
- Direct income: **7M€** (32 projets: ANR, FP7,...)
- Indirect incomes: **5M€** (15 projets: ANR, FP7, ERC,...)
- Overall awarded money (with partners) : **78M€**

260 articles de journaux sur 2009-2016 (4806 citations)

31% of articles (80) in top 10% (*according to ESI Physics criteria*)

6% of articles (16) in top 1%

- **4 start-up** benefited directly from results initiated with program
- **29 patents** (2008-2013)

FULLFLEX PROTOTYPE CHALLENGE?

Objectif: go beyond germination!

Build a prototype Integrating technological components developed within Nanoscience & ChimTronic seed projects

- Reach higher TRL

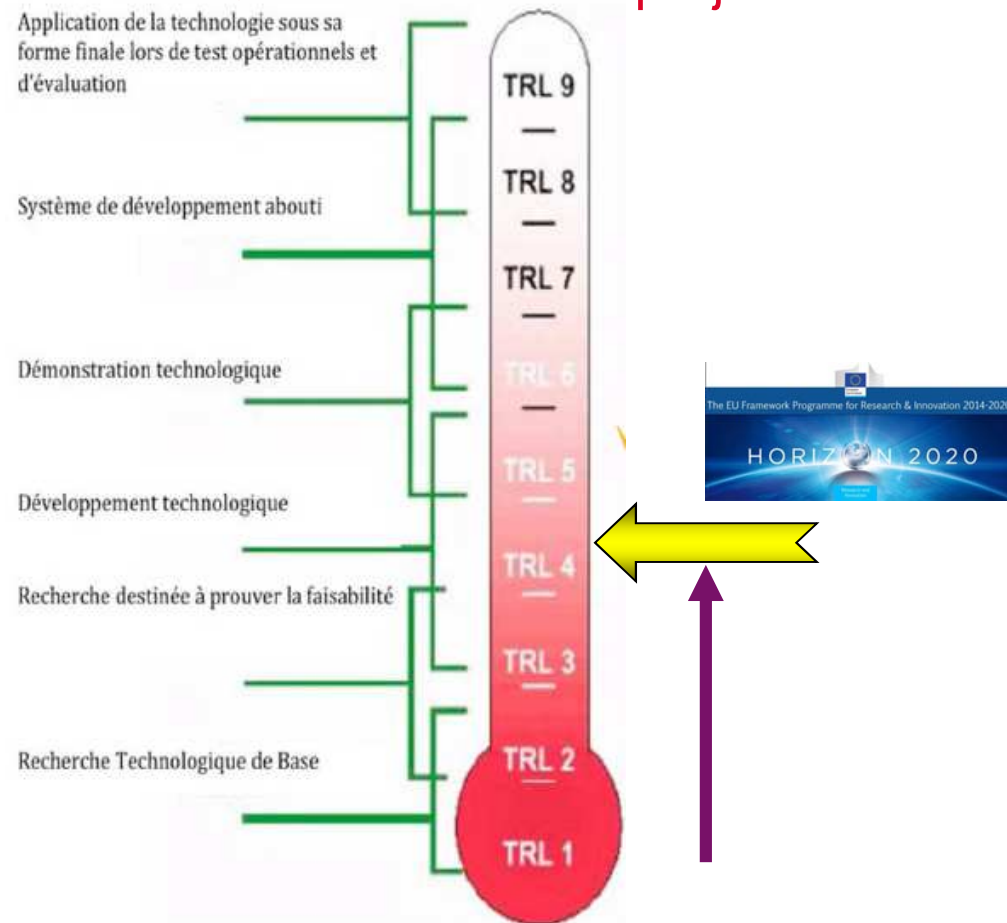

FULLFLEX PROTOTYPE CHALLENGE?

Objectif: go beyond germination!

Build a prototype Integrating technological components developed within Nanoscience & ChimTronic seed projects

- ❑ Reach higher TRL
- ❑ Development of new technologies of flexible interconnects
- ❑ => A new prototype for CEA's Showroom



FULLFLEX PROTOTYPE CHALLENGE?

Objectif: go beyond germination!

Build a prototype Integrating technological components developed within Nanoscience & ChimTronic seed projects

- Reach higher TRL
- Development of new technologies of flexible interconnects
- => A new prototype for CEA's Showroom

Initial Concept: a flexible autonomous, multifunctions label

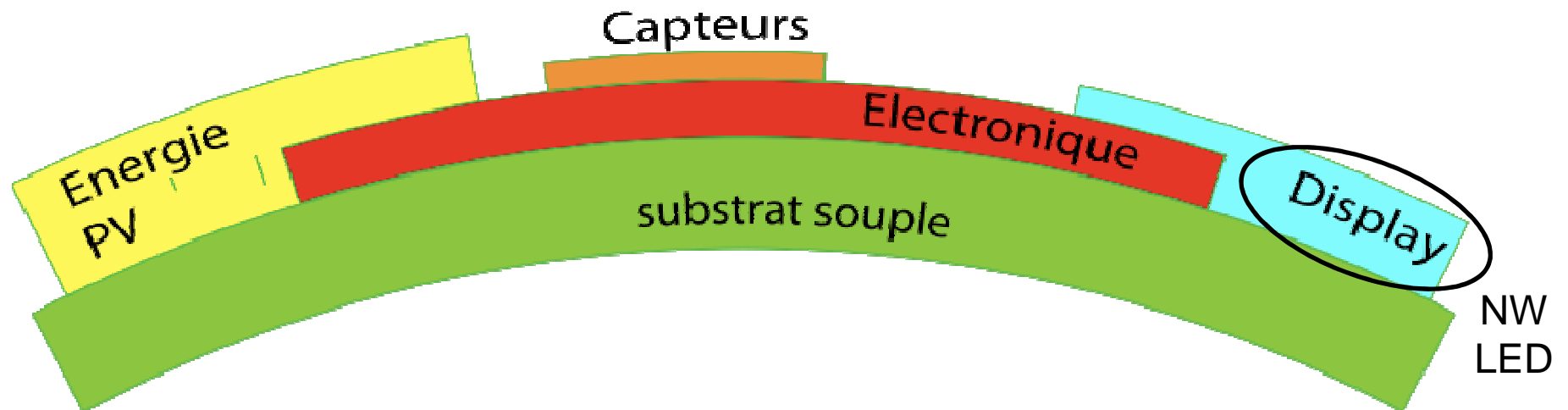

FULLFLEX: WHAT TEAM?

| Component | Investigators | Affiliation |
|--|---|--------------------------|
| Battery (Si NP) | Marc BRESTAZ | DRT/LITEN/DEHT/LCPB |
| | Séverine JOUANNEAU | DRT/LITEN/DEHT/LCPB |
| | Willy PORCHER | DRT/LITEN/DEHT/LCPB |
| | Axelle QUINSAC (NTE) | DSM/IRAMIS/SPAM/EDNA |
| | Yann LECONTE | DSM/IRAMIS/SPAM/EDNA/LFP |
| | Nathalie HERLIN | DSM/IRAMIS/SPAM/EDNA |
| PV organic | Rémi DE BETTIGNIES | DRT/LITEN/DTS/LMPV |
| | Nicolas GAUTHIER | DSM/INAC/SCIB/RICC |
| | Marinella MAZZANTI | DSM/INAC/SCIB/RICC |
| | Daniel IMBERT | DSM/INAC/SCIB/RICC |
| | Renaud DEMADRILLE | DSM/INAC/SPRAM/LEMOH |
| | Amélie REVAUX | DRT/LITEN/DTNM/LCSN |
| LED (NW) | Benoit AMSTATT + François LEVY & Alexandre LAGRANGE | DRT/LETI/DOPT/SCOOP/LCE |
| | Joël EYMERY + Benjamin GREVIN | DSM/INAC |
| Transparente Electrode (CNTs or NW) | Eléonore MOREAU | DRT/LITEN/DTNM/LCRE |
| | Jean-Pierre SIMONATO + Caroline CELLE | DRT/LITEN/DTNM/LCRE |
| | Benjamin GREVIN + | DSM/INAC |
| | Renaud DEMADRILLE | DSM/INAC |
| Printed Electronics | Abdelkader ALIANE | DRT/LITEN/DTNM/LCEI |
| | Romain COPPARD | DRT/LITEN/DTNM/LCEI |
| System /integration | Jean-François MAINGUET | DRT/LETI/DSIS/SIPP |
| | Tristan HAUTSON | DRT/LETI/DSIS/SIPP |
| | Pascale RIVIER | DRT/LETI/DSIS/SIPP |
| Pilotage | Jean-Christophe GABRIEL | DSM/DIR/DPNS |
| | Norbert DANIELE | DRT/LETI/DSIS/SIPP |
| | Tiana DELHOME | DRT/LETI/DSIS/SIPP |

DE LA RECHERCHE À L'INDUSTRIE



www.cea.fr

All this presentation is the property of CEA.
Copyright CEA, all rights reserved, cannot be used without CEA's consent

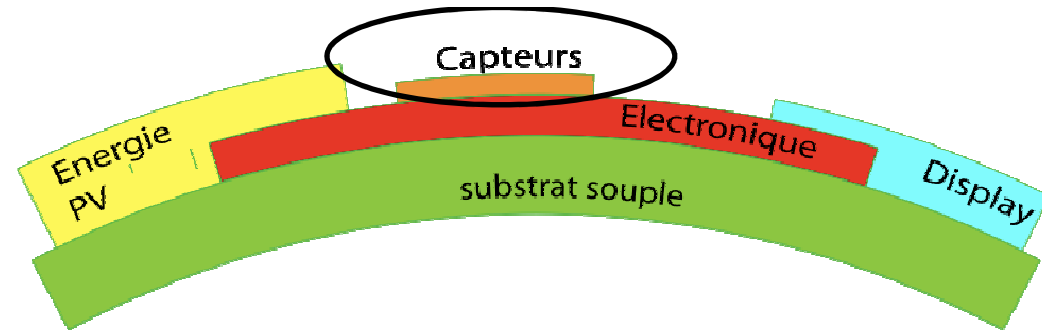

Printed Temperature Sensors

Abdelkader Aliane





PRINTED ORGANIC ELECTRONICS @CEA/LITEN

PLED (Polymer Light-Emitting Diodes)

HMI, signage

Devices, systems

Single digit, matrix

Logos

cf Talk Tony Maindron (OLED)

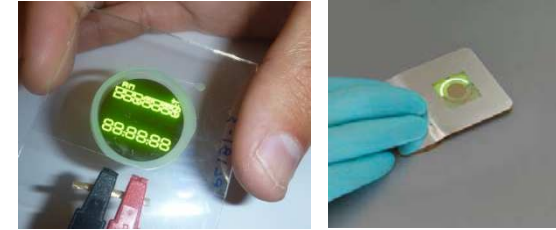
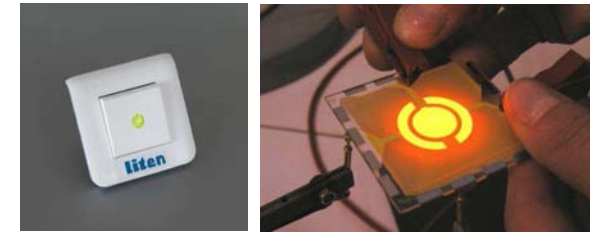

Antennas



Sensors

Temperature (Resistors)

Capacitive

Pressure sensitive

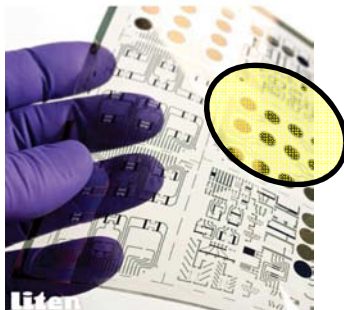

Large Surface Printing Platform (PICTIC):

- 50 researchers and technicians
- €9 million in investment
- 600 sq. m of clean rooms
- Slot-die, gravure, flexography process equipment
- Industrial partnerships, startup (ISORG)

DE LA RECHERCHE À L'INDUSTRIE

cea

www.cea.fr

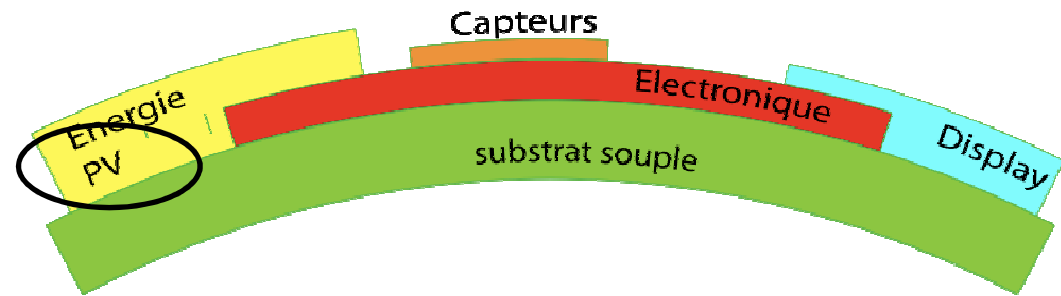

Photovoltaic flexible modules



Renaud DEMADRILLE – DRF / INAC / LEMOH

Solenn Berson – DRT/INES/SMPV

Bulk-heterojunction solar cells (BHJ) : Concept

Heeger et al. *Science*, 1992, 258, 1474.

- 2 Interpenetrated percolating networks
- Optimal phase segregation (10-20nm)

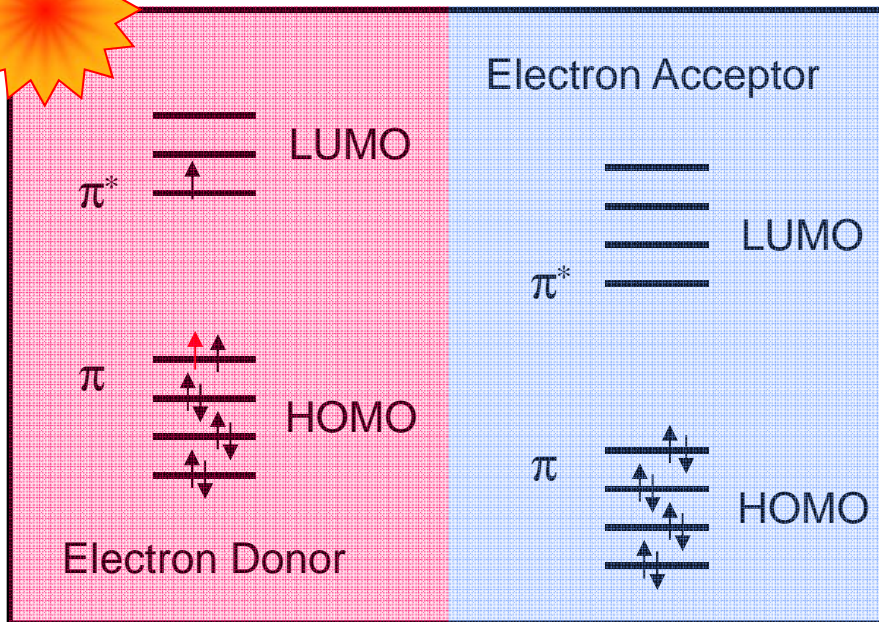
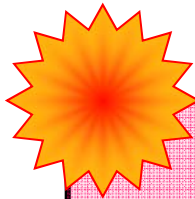

Photo-induced charge transfer

Copyright CEA, all rights reserved

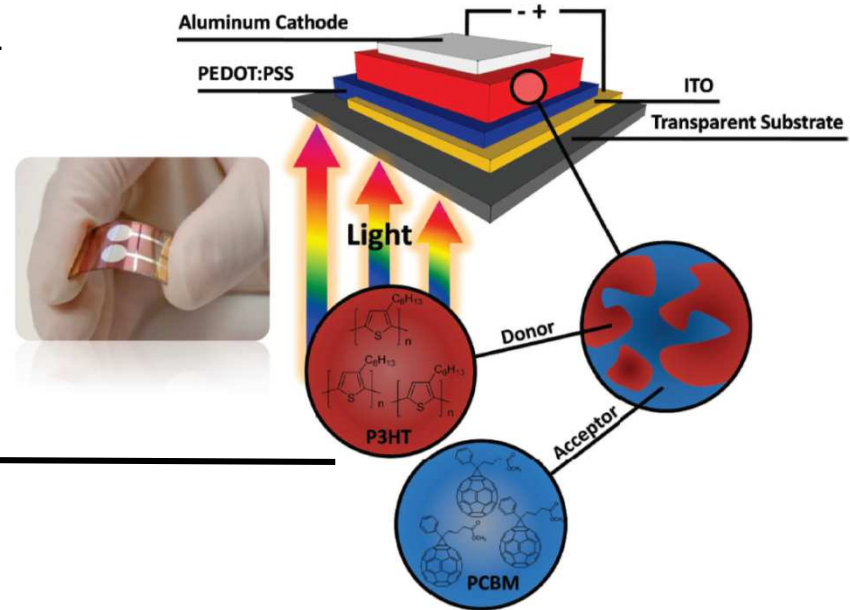
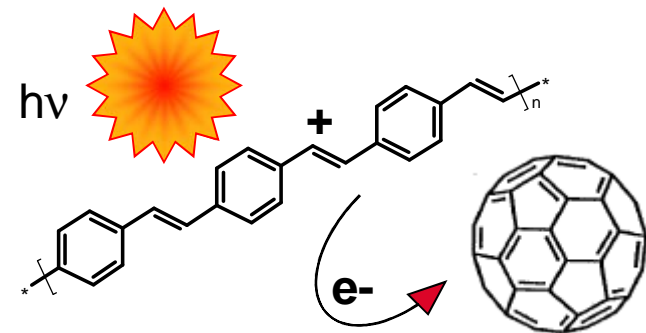
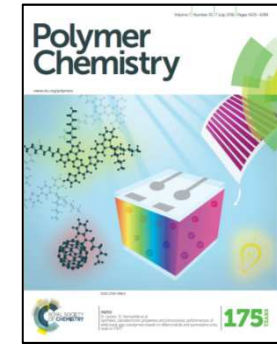
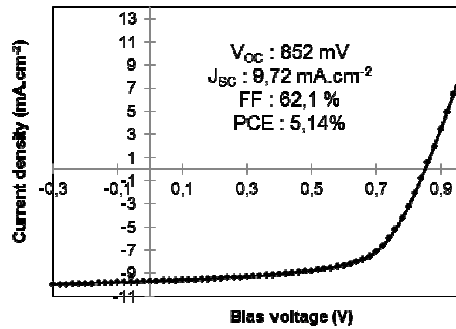
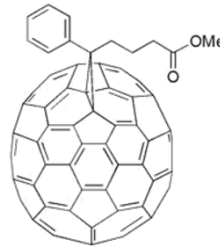
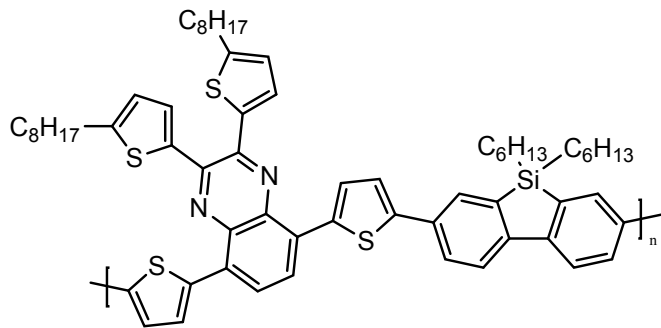

Photo-induced charge transfer $< 10^{-12}$ s



Development of new materials for use in the active layer



Polymer Chem., 2016, 7, 4160

Laboratoire des Modules Photovoltaïques Organiques (LMPO) – S. Berson (DRT-INES)



Development of OPV modules by printing techniques (ink-jet)
 First examples with P3HT

P3HT-Fullerene $S = 11,04 \text{ cm}^2$

PCE = 2,9%
 $V_{oc} = 1,61 \text{ V}$
 $J_{sc} = 3 \text{ mA/cm}^2$
 $FF = 60 \%$

PCE = 2,1%
 $V_{oc} = 4,9 \text{ V}$
 $J_{sc} = 1.1 \text{ mA/cm}^2$
 $FF = 40 \%$

P3HT-Fullerene

Printed modules : S.Berson, R. De Bettignies, DRT-INES

P = 30mW

Cf talk Solenn Berson

Compatible with Li Ion batteries
 $V_{min} = 3.7V$

Copyright CEA, all rights reserved

PV DEVELOPED FOR THE LABEL

All Interconnects: conducting adhesive

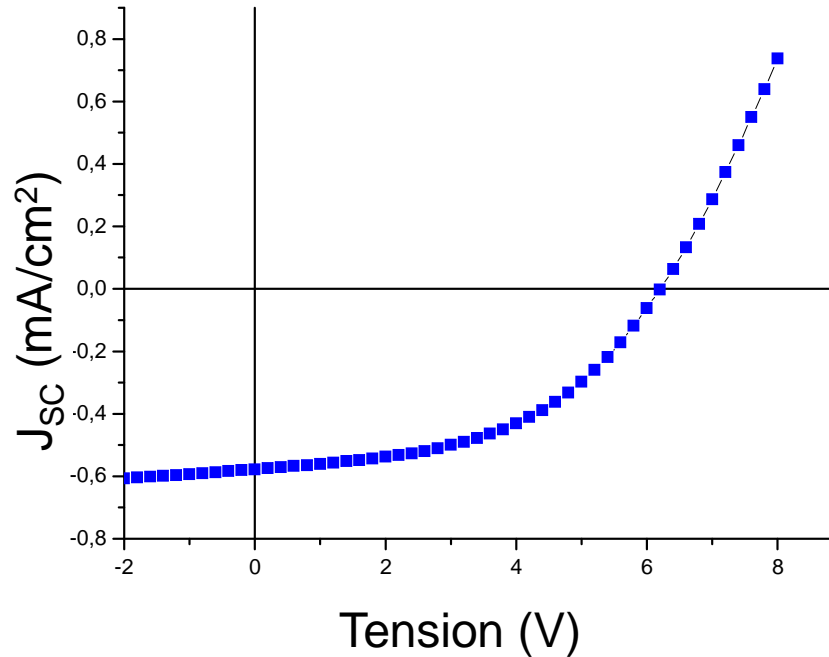
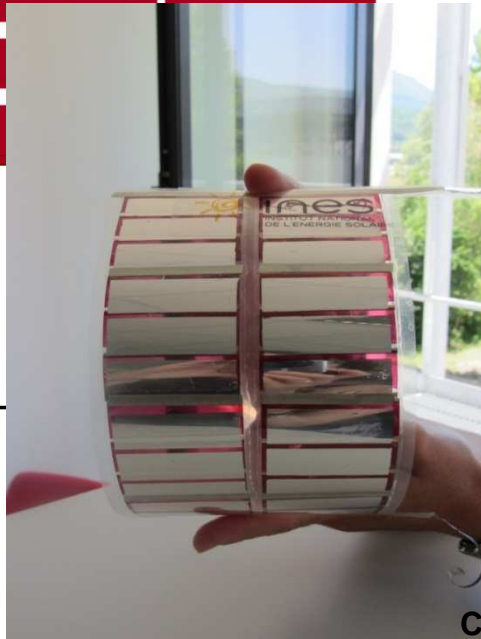
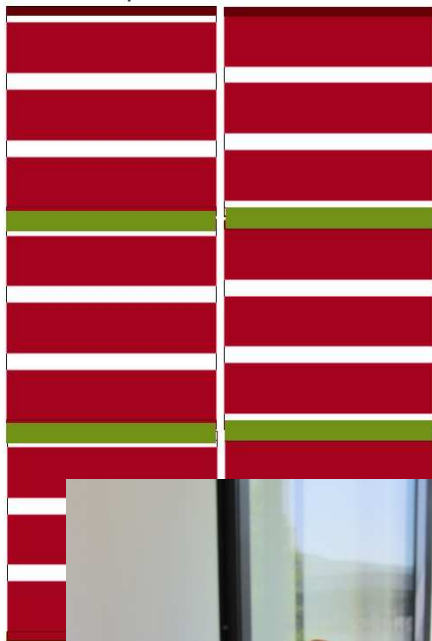

Voc= 6.2 V
Jsc= 0.577 mA/cm²
FF= 48.2 %
PCE= 1.73 %
Vmax = 4.1V
Imax = 35.8 mA

DE LA RECHERCHE À L'INDUSTRIE



www.cea.fr

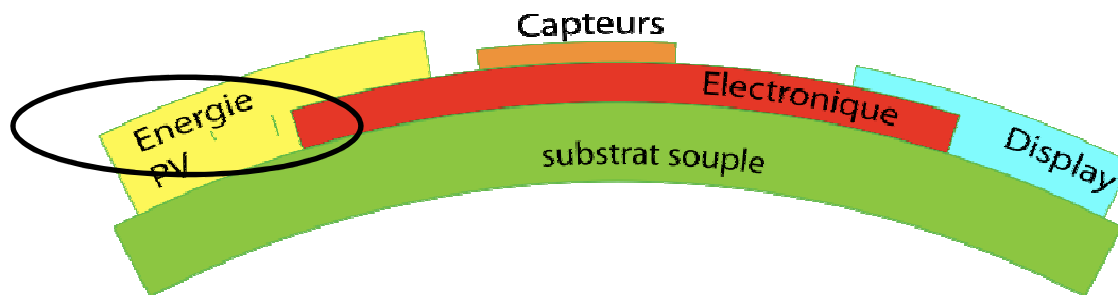

Silicium NP based battery

Nathalie Herlin, Séverine Jouanneau,

Willy Porcher

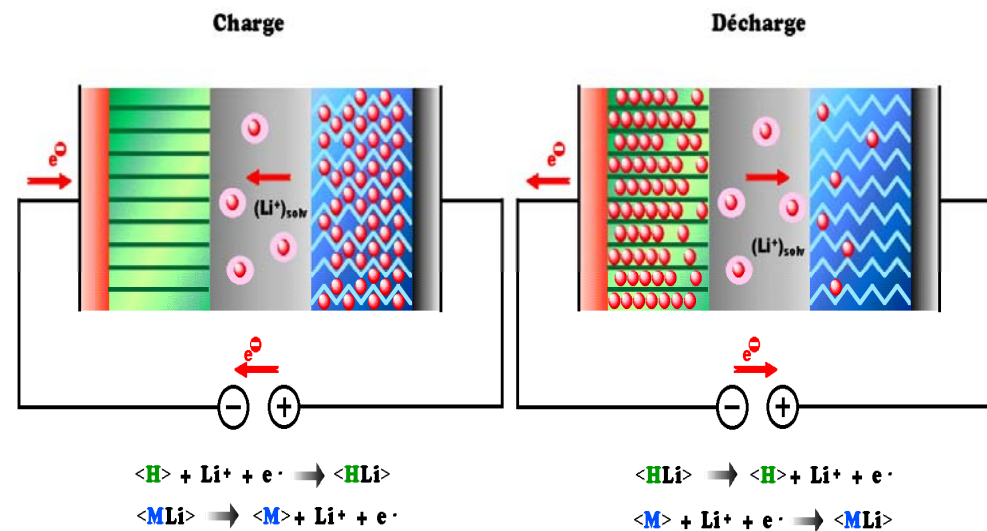

Batteries lithium-ion

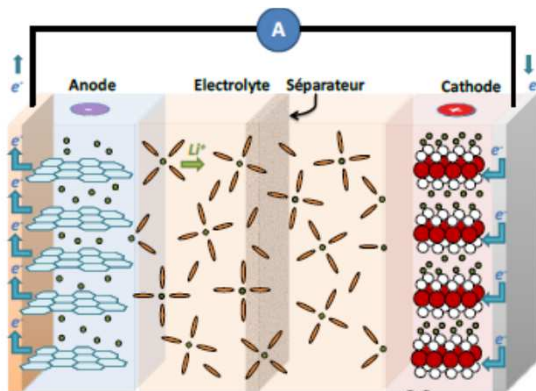

AVANTAGE :

Max = 3578 mAh/g (Si → Li_{3,75}Si) = 10x graphite

DISAVANTAGE: $V_{inc} = +280\%$

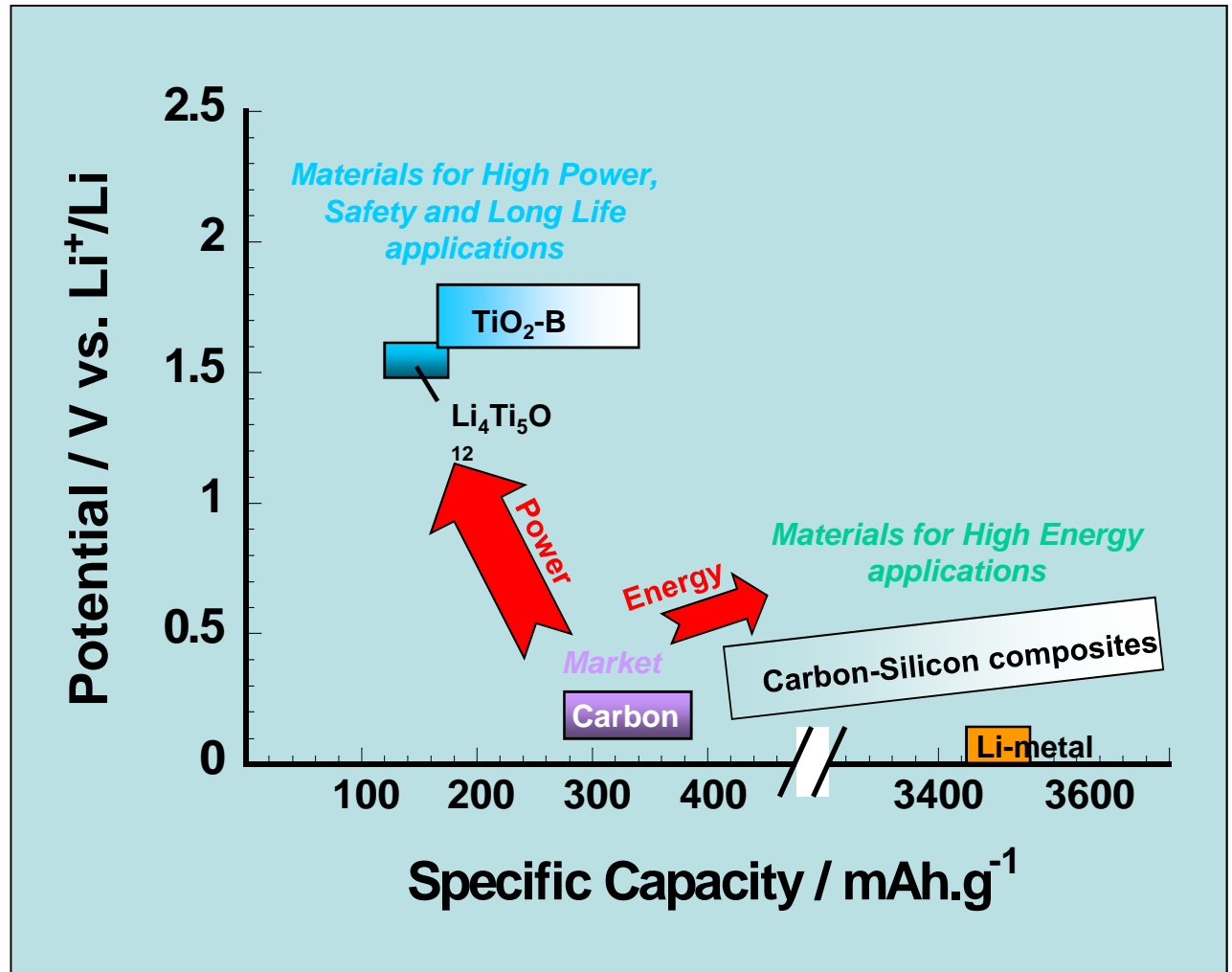

=> NP Si

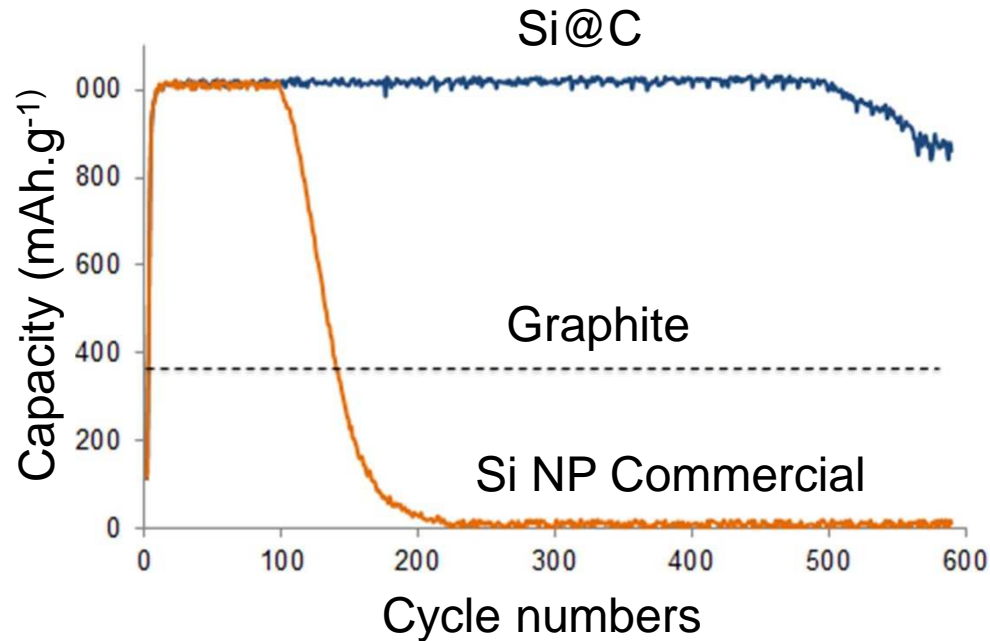

- Core-shell amorphous silicon-carbon nanoparticles for high performance anodes in lithium ion batteries
- *Journal of Power Sources* **328** (2016) 527-535
- Patent: US9205399 (2015), US20150299861, US20150303462
- 1 startup (Nanomakers)

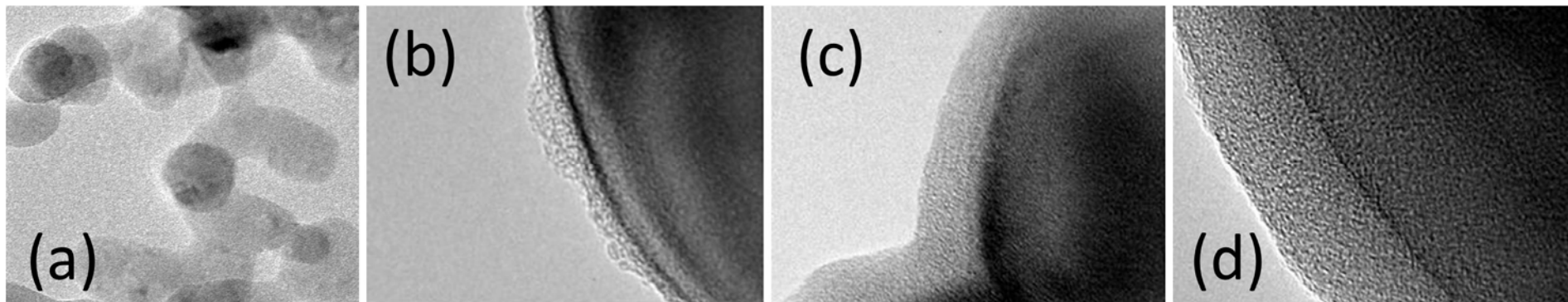

NP Si@C: Amorphous C layer = 3nm

10 nm

15 nm

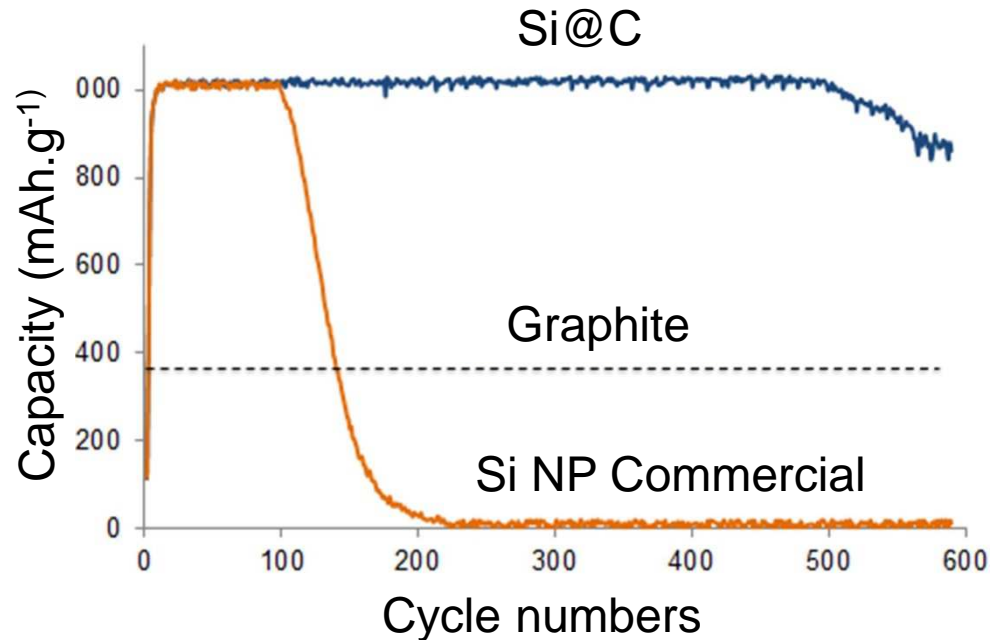

- Core-shell amorphous silicon-carbon nanoparticles for high performance anodes in lithium ion batteries
- *Journal of Power Sources* **328** (2016) 527-535
- Patent: US9205399 (2015), US20150299861 US20150303462
- 1 startup (Nanomakers)

Overall

Positive Electrode: NMC ($\text{LiNi}_{1/3}\text{Mn}_{1/3}\text{Co}_{1/3}\text{O}_2$)

Ref. Element: 3Ah for 3x3 cm x 5 mm cell

Power < 3W

Surface capacity: 3 mAh/cm²

Voltage : 3,5 V

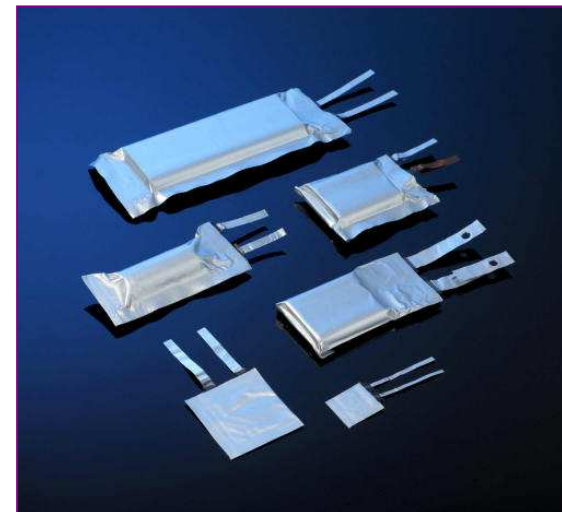

To simplify or solve several technological barriers, another battery architecture is possible:
the interdigitated planar design

- **The interdigitated concept reverses at 90 ° stacked architecture**
 - ✓ Architected current collectors on the same plane
 - ✓ Electrodes printed side by side on respective collectors
 - ✓ Separator printed between the electrodes printed on the entire surface
 - ✓ Gellified electrolyte
- **Constraints of the concept:**
 - ✓ High printing resolution(10µm +/- 1µm)

- Dimensions:
 - Width of lines : 200µm
 - Distance between lines : <100µm (target 50µm) → electrolyte compartment
- Solid electrolyte configuration
- No densification

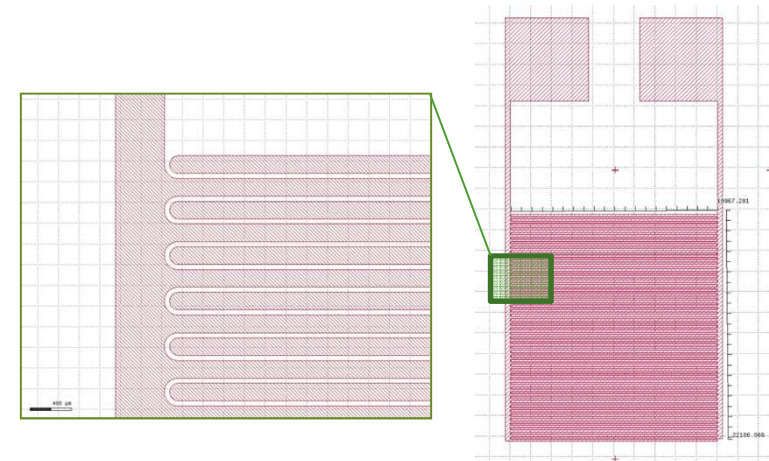
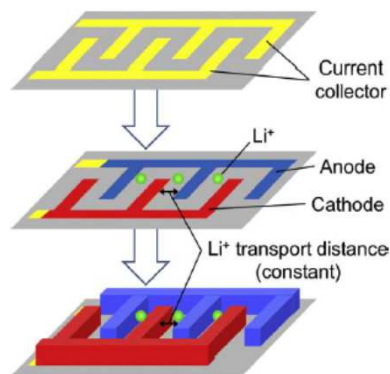
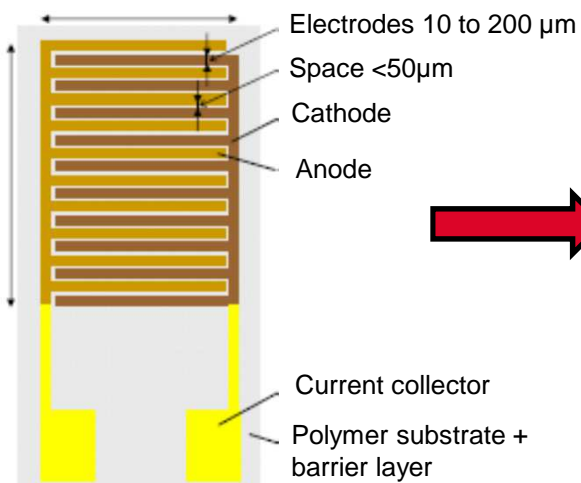

Patent BF3007206

=> Thomas Yohann

Copyright CEA, all rights reserved

Current collectors
Electrodes
Electrolyte

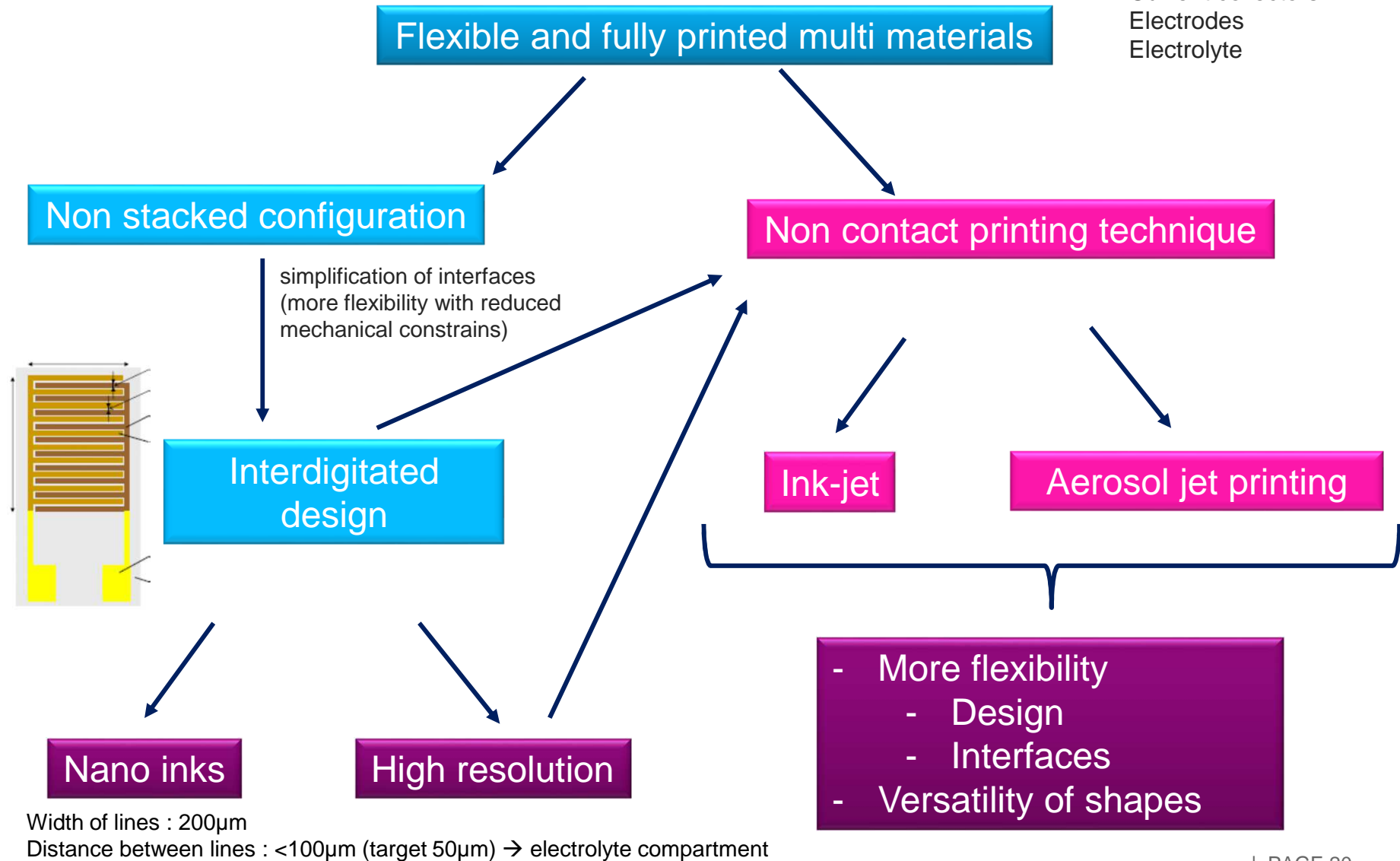

DE LA RECHERCHE À L'INDUSTRIE

cea

www.cea.fr

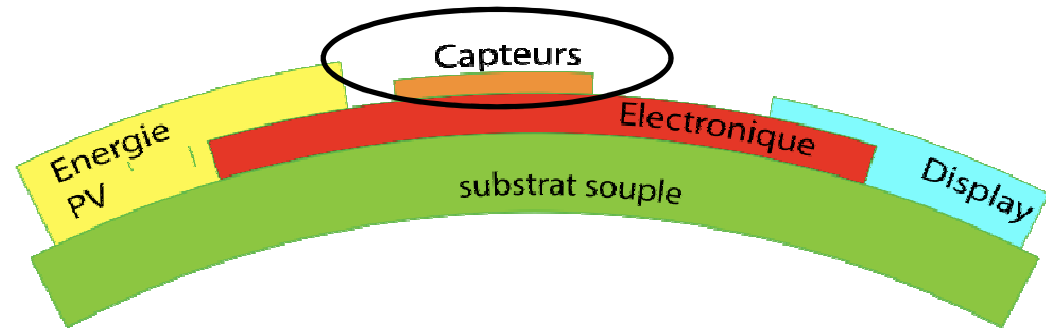

Transparent Electrode + Capacitive Sensors

JEAN-PIERRE SIMONATO

A NEW NEED FOR FLEXIBLE TRANSPARENT ELECTRODES



TCOs (ITO) have serious limitations

- × *Indium is a major critical raw material*
- × *High cost process (capex, material)*
- × *Brittleness*

Alternatives ?

- ✓ *Conductivity / Transparency*
- ✓ *Flexibility / stretchability*
- ✓ *Low cost (material / process)*

SUBSTITUTION of ITO by Nanomaterials

➤ Conducting polymers

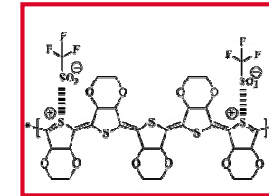
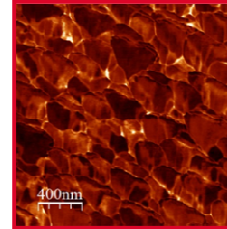

➤ Carbon Nanotubes

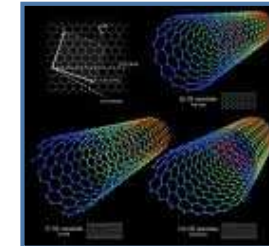
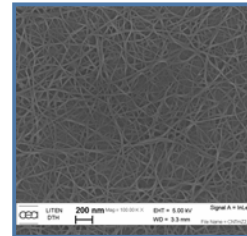

➤ Graphene

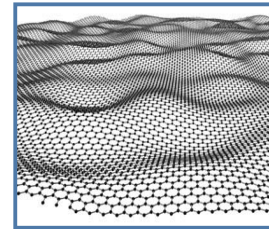
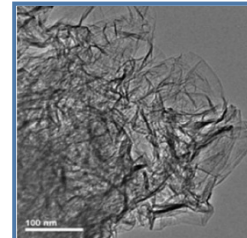

➤ Metallic nanowires

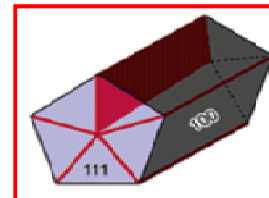
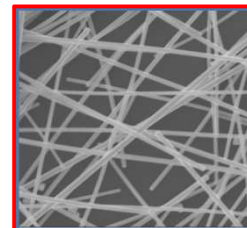

| | |
|-------------------------------------|--|
| <p>➤ Conducting polymers</p> | <p><i>J. Mater. Chem. C</i>, 2014 <i>Chemical Science</i>, 2015 <i>Chemistry of Materials</i>, 2016</p> |
| <p>➤ Carbon Nanotubes</p> | <p><i>Nano Letters</i>, 2003 <i>Carbon</i>, 2012 <i>Carbon</i>, 2014</p> |
| <p>➤ Graphene</p> | <p><i>Applied Physics Letters</i>, 2014 <i>Ultramicroscopy</i>, 2015</p> |
| <p>➤ Metallic nanowires</p> | <p><i>Nanoscale</i>, 2015 <i>Small</i>, 2016 <i>Nano Research</i>, 2012, 2014 <i>Nanotechnology</i>, 2013 x 2 <i>Nano Letters</i>, 2016</p> |

Ag NW SYNTHESIS: COMPLICATED?

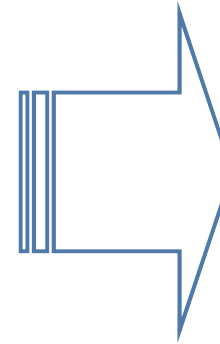
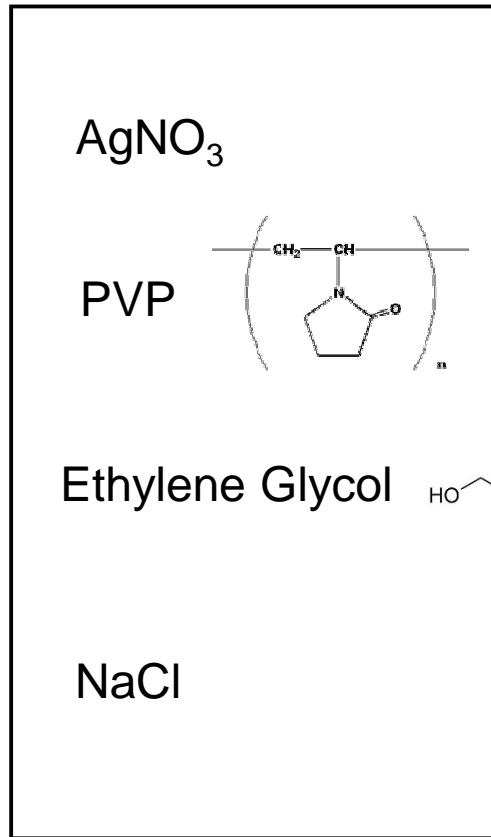

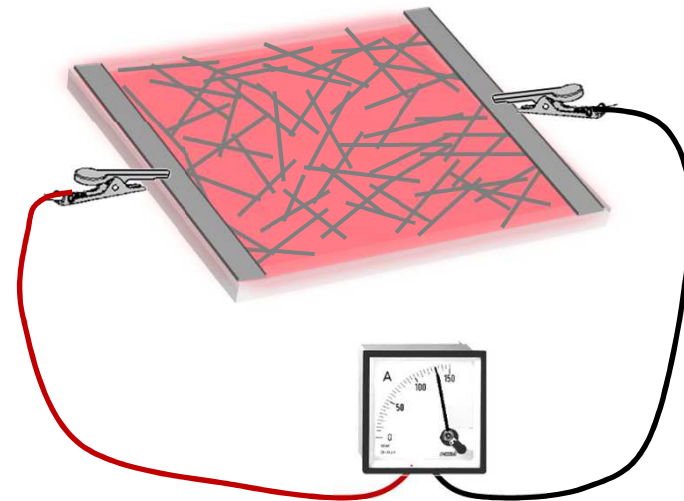
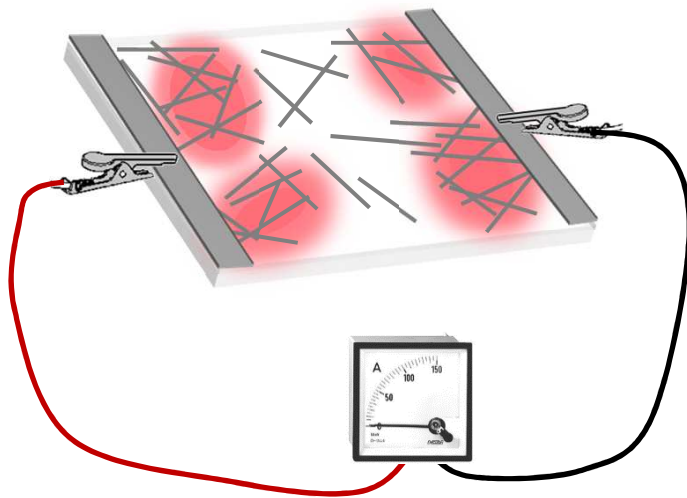

Percolation

~ 15 PATENTS

Copyright CEA, all rights reserved

SPRAY-COATING, A METHOD OF CHOICE

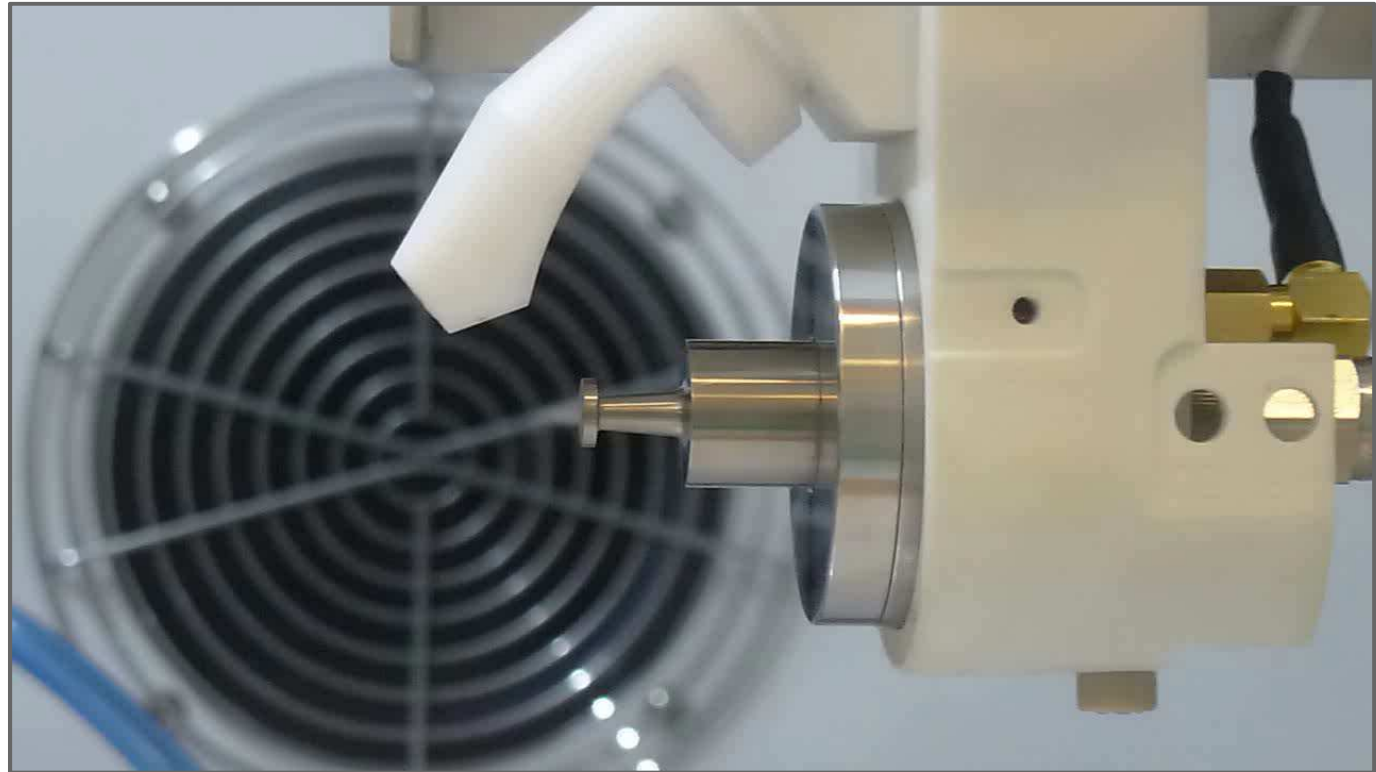

Copyright CEA, all rights reserved

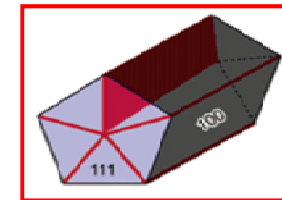
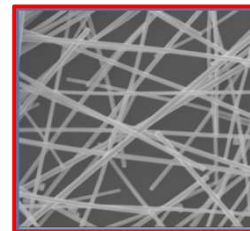
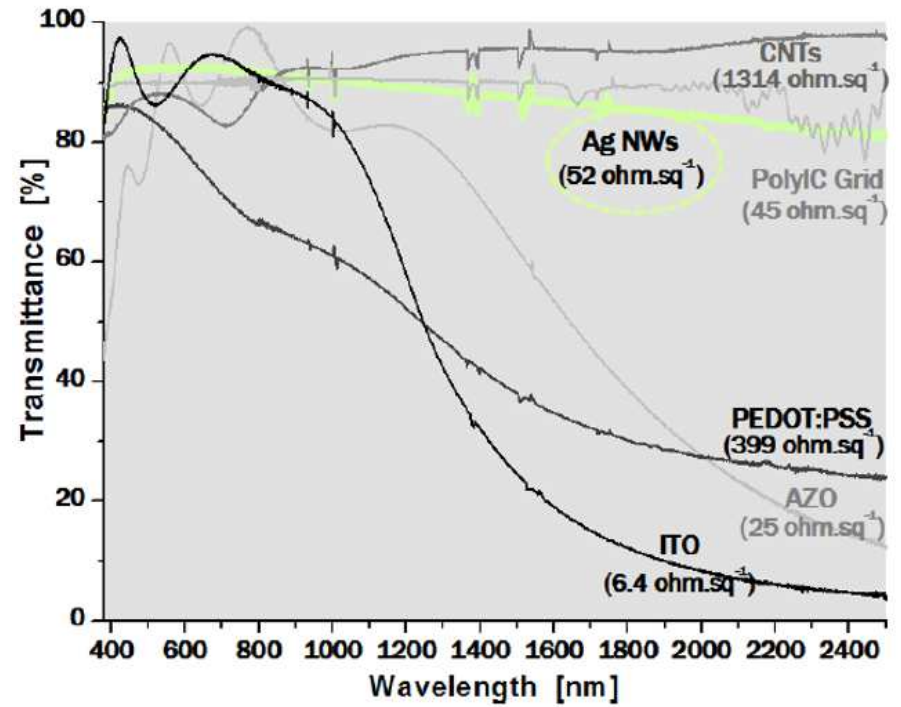
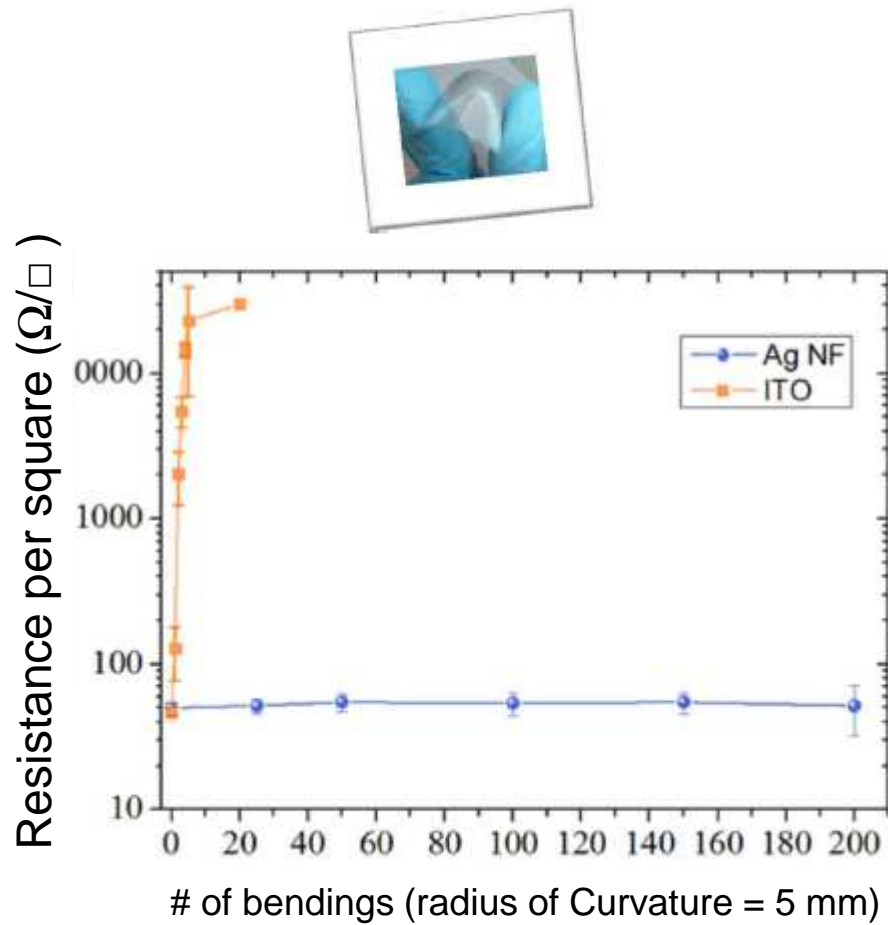

Copyright CEA, all rights reserved

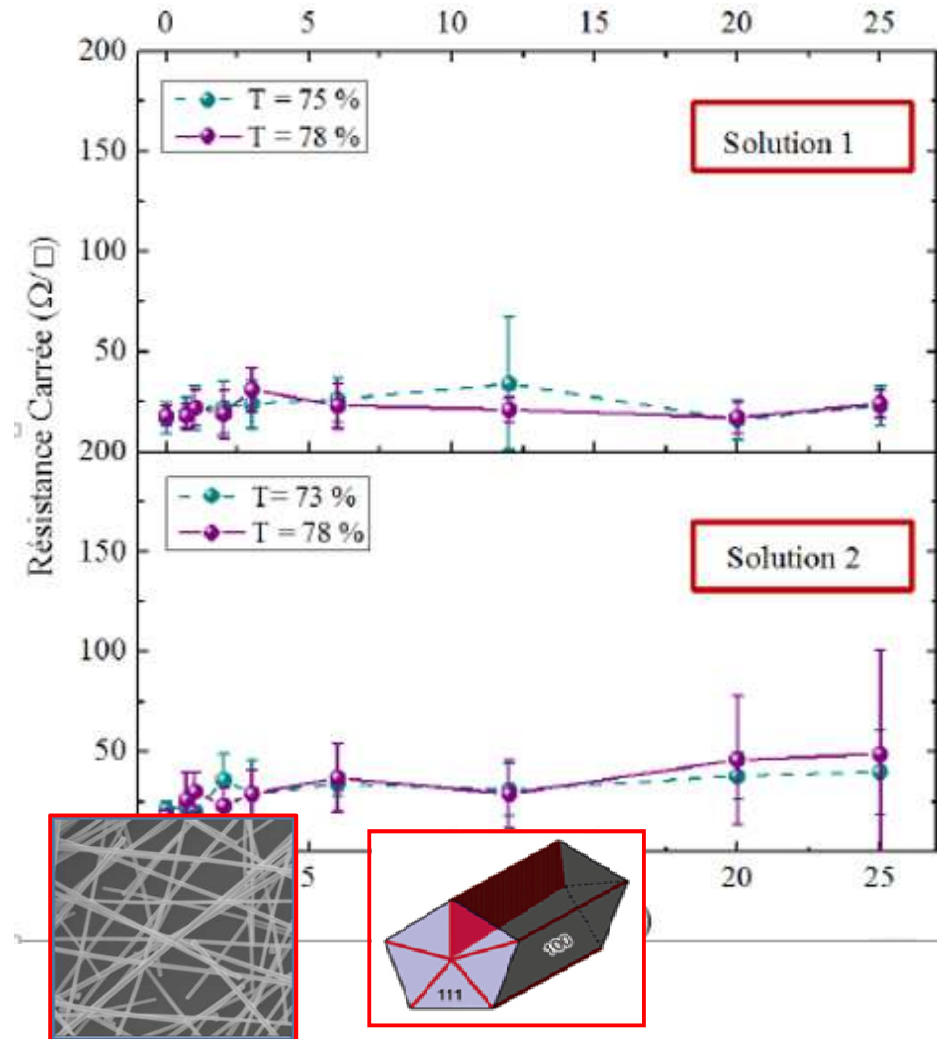
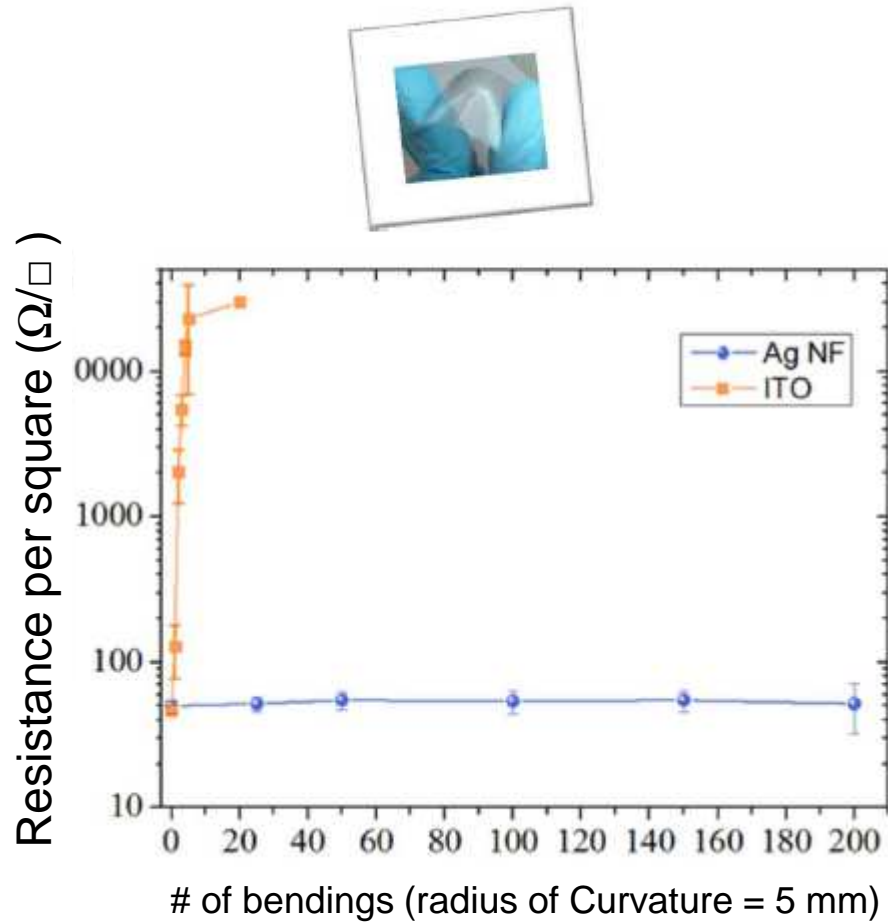

DE LA RECHERCHE À L'INDUSTRIE

cea

www.cea.fr

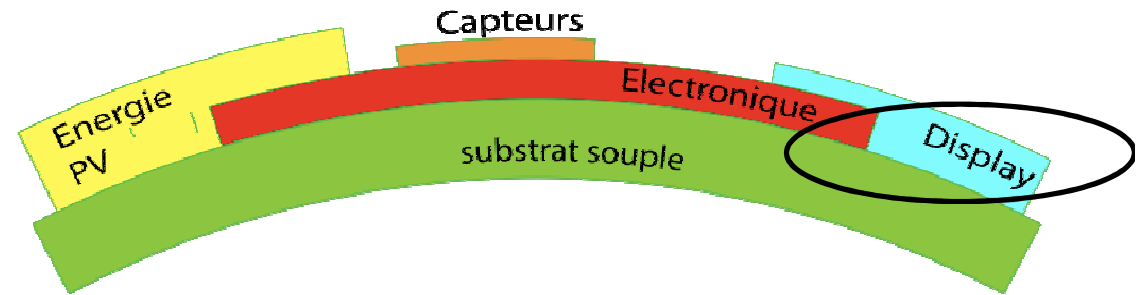

Nanowire based LED

JOËL EYMERY, FRANÇOIS LEVY

NITRIDE NW BY CATALYST-FREE MOVPE

- 1 Nitridation under NH_3 and SiN deposition



- 2 Wire growth under Silane injection and low V/III ratio

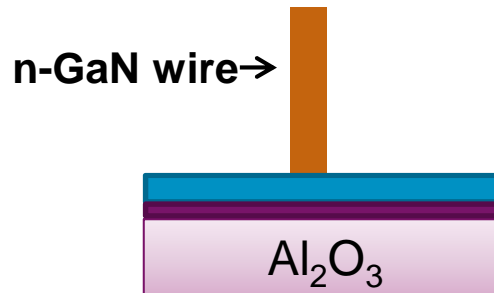

- 3 InGaN QW growth and p-GaN capping layer

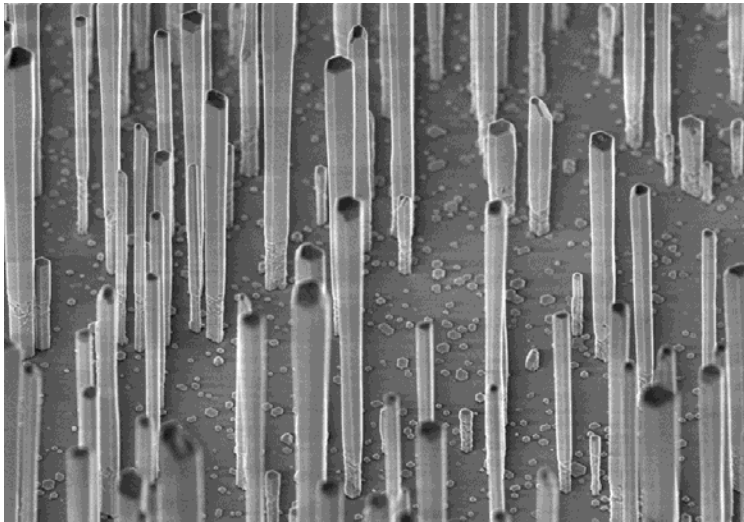
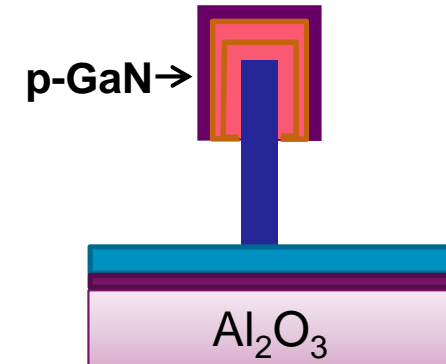

Nanowire morphology

- **Diameter** : 500 nm – 2 μm
- **Height** : 10 – 30 μm
- **Density** : 10^7 cm^{-2}

Spontaneous growth – big surface available for process optimization

MOCVD growth by C. Durand, J. Eymery (CEA-Grenoble)

Koester et al., *Nanotechnology* 21, 015602 (2010)

GAN NW BASED LEDS: FROM SOLID SUBSTRATES...

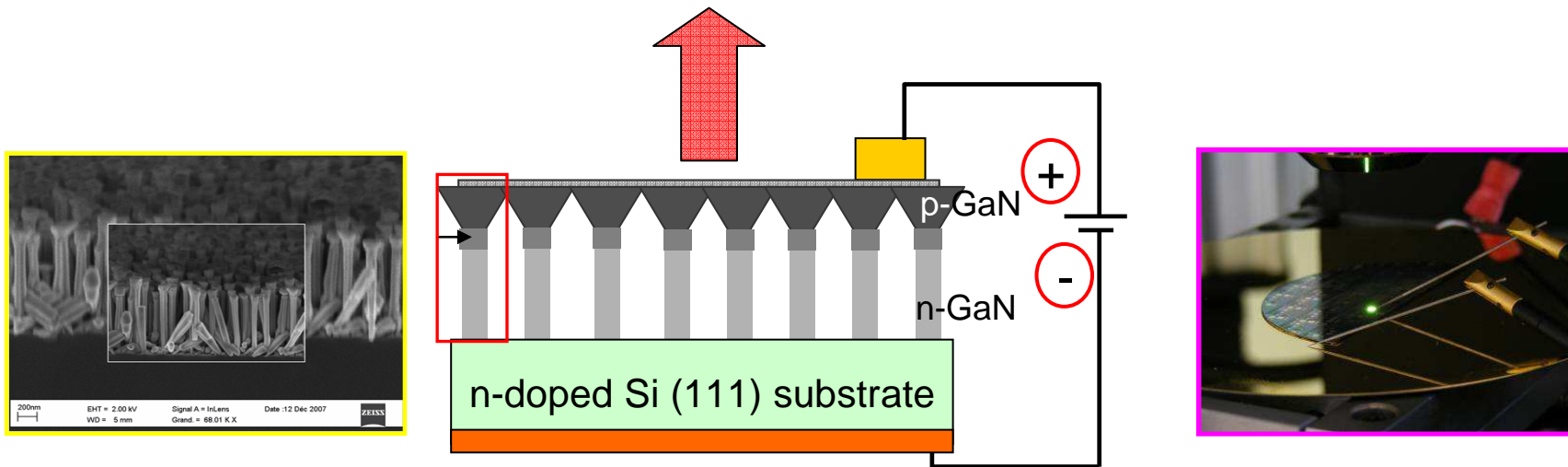

A-L Bavencove et al., Nanotechnology 22 (2011) 345705
Submicrometre resolved optical characterization of green nanowire-based light emitting diodes

InGaN/GaN NWs / PDMS

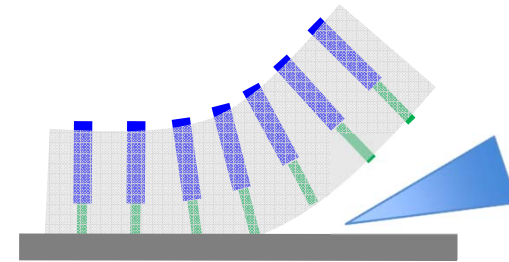
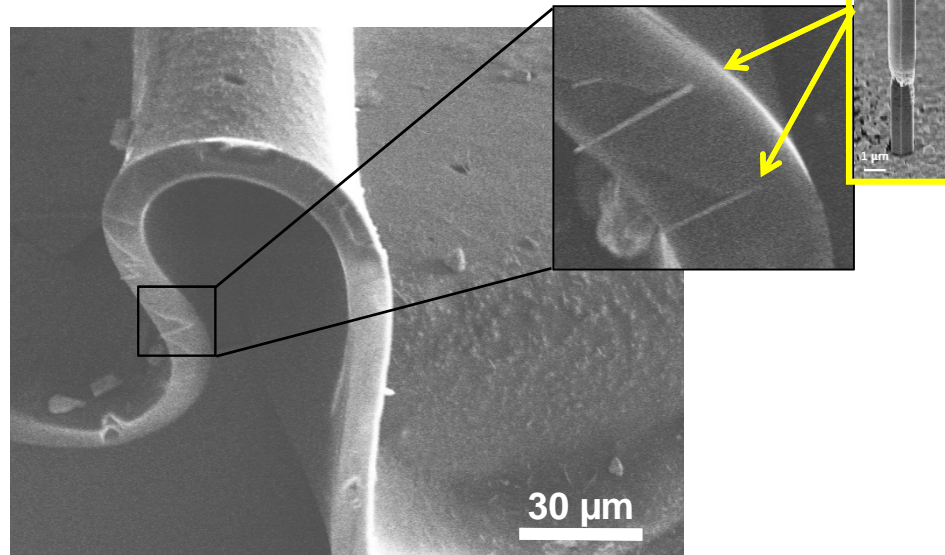

- GaN nanowires embedded into PDMS
- Mechanical lift-off of the composite film
- Back-side metallization and mounting on PET substrate

Main challenge – transparent flexible contact

- Thin TCO layers
- Graphene and/or graphene μ -flakes
- **Silver nanowire mesh**

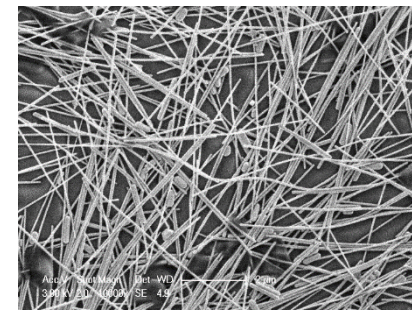

V. Neplokh, et al, Nanosc Res Lett 2015

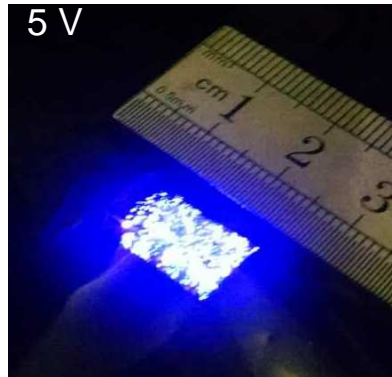

Blue LED

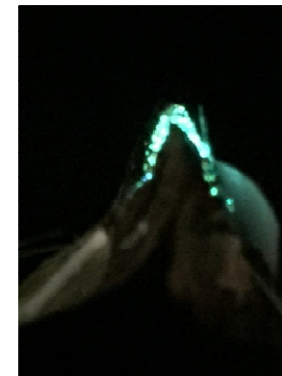

Green LED

- Large area flexible LEDs (active area of several cm²)
- No I-V or EL degradation after 10 bending cycles ($R_{\text{bending}} \approx 0.3 \text{ cm}$)
- Further improvement of emission homogeneity with organized NW arrays is under investigation

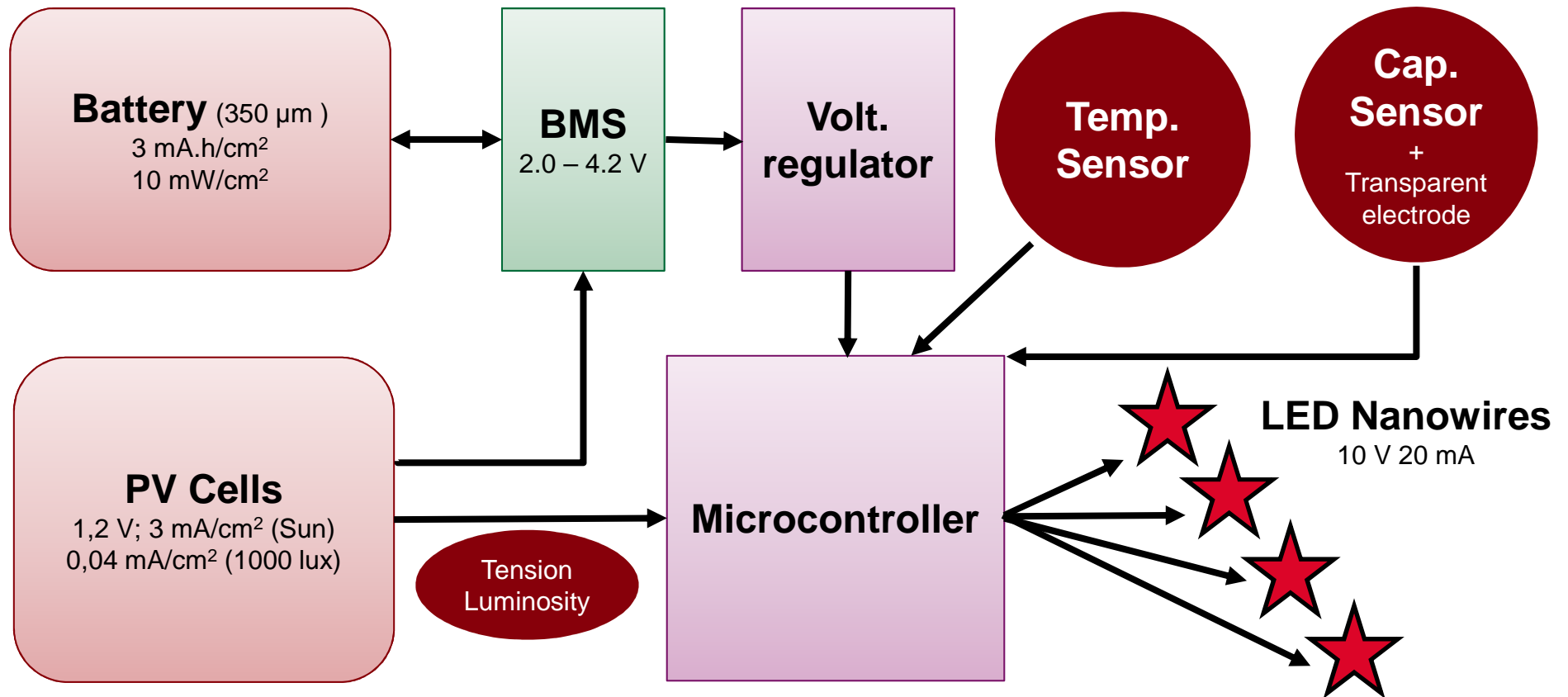

Three Sensors: Light, temperature, capacitive
Copyright CEA, all rights reserved

OVERALL ASSEMBLY?

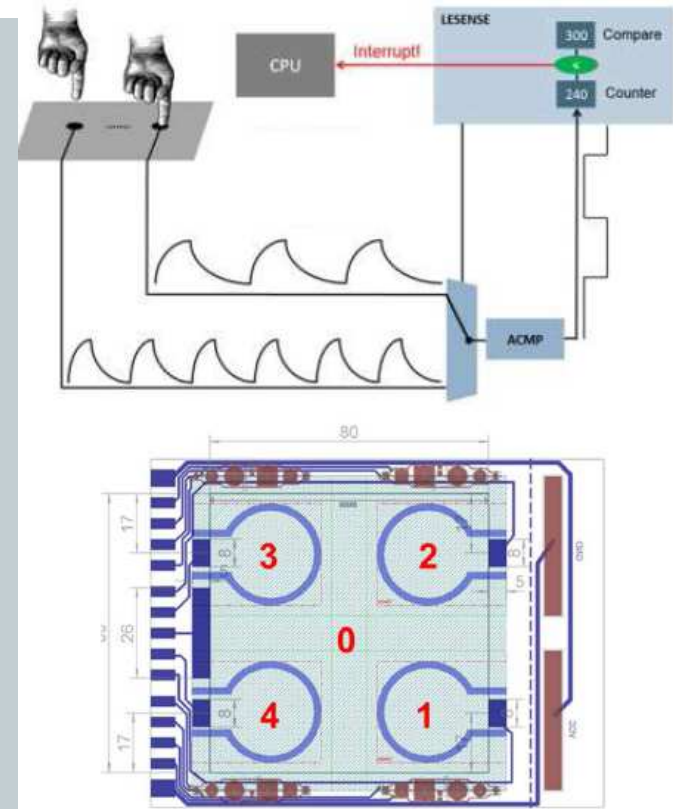
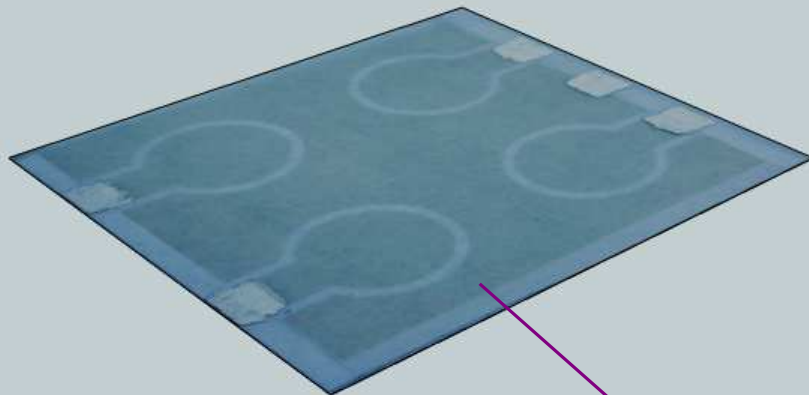

Silver Nanowires
Transparent electrode

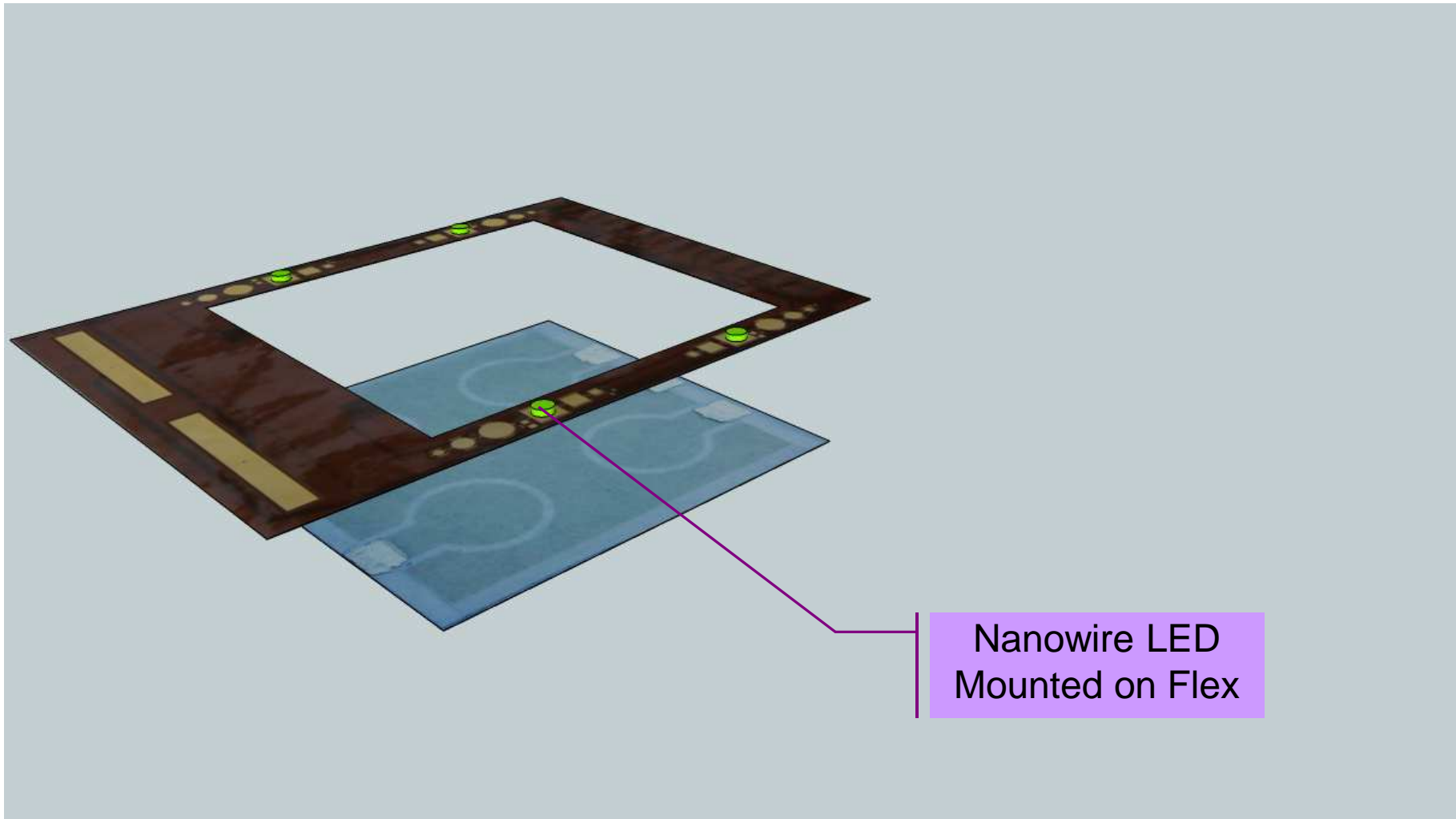

Flexible electronic mother board

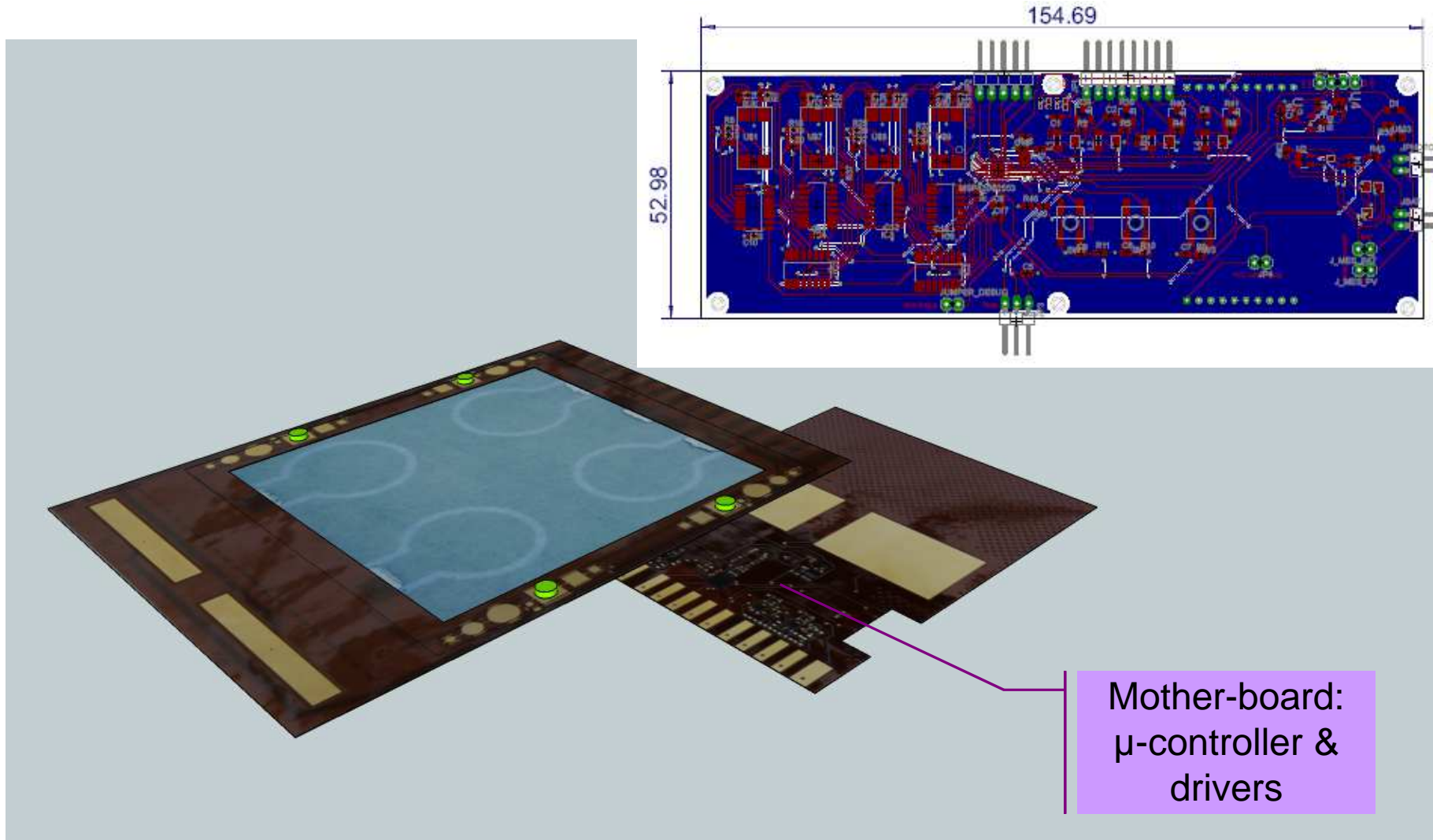

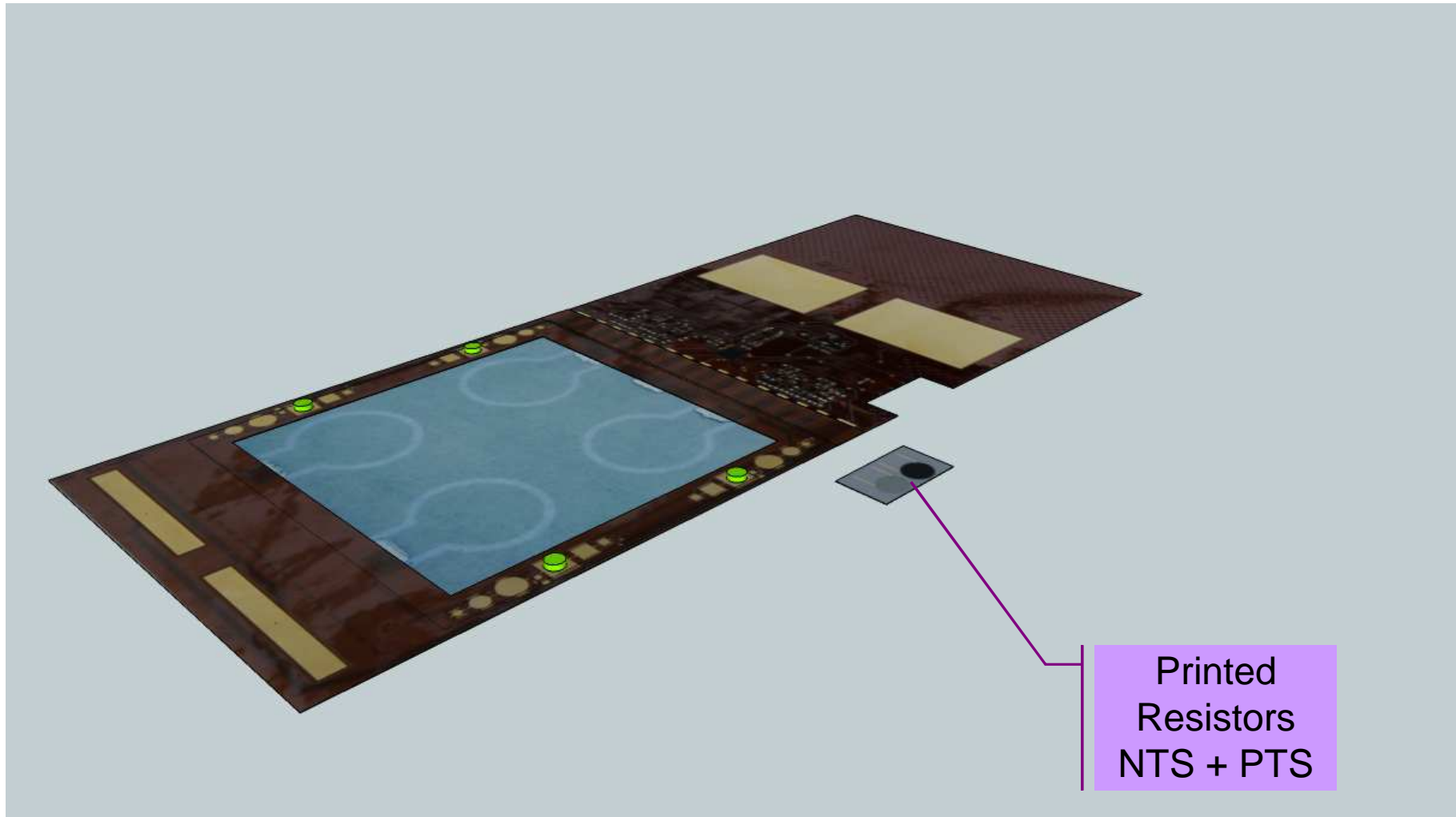

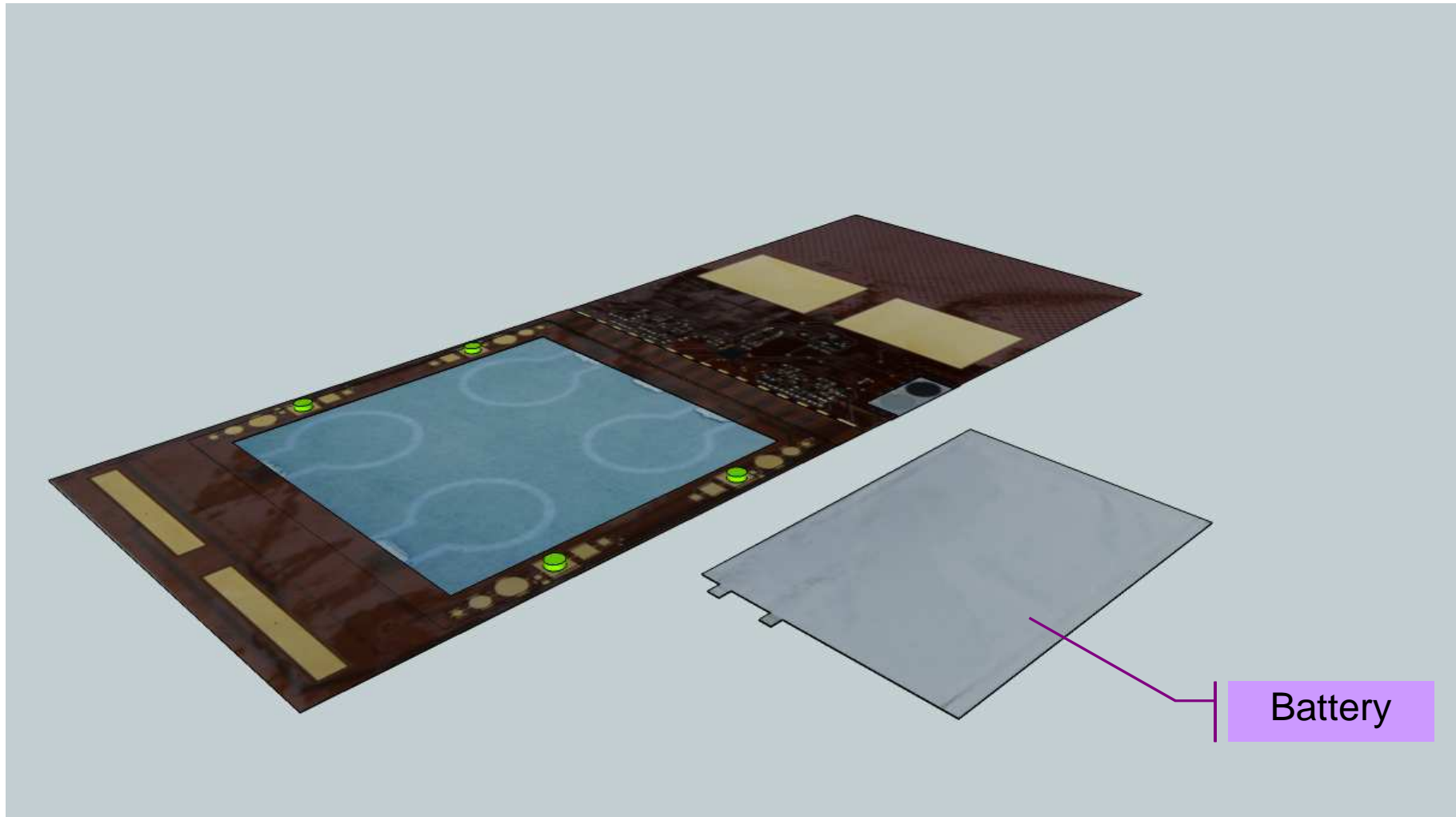

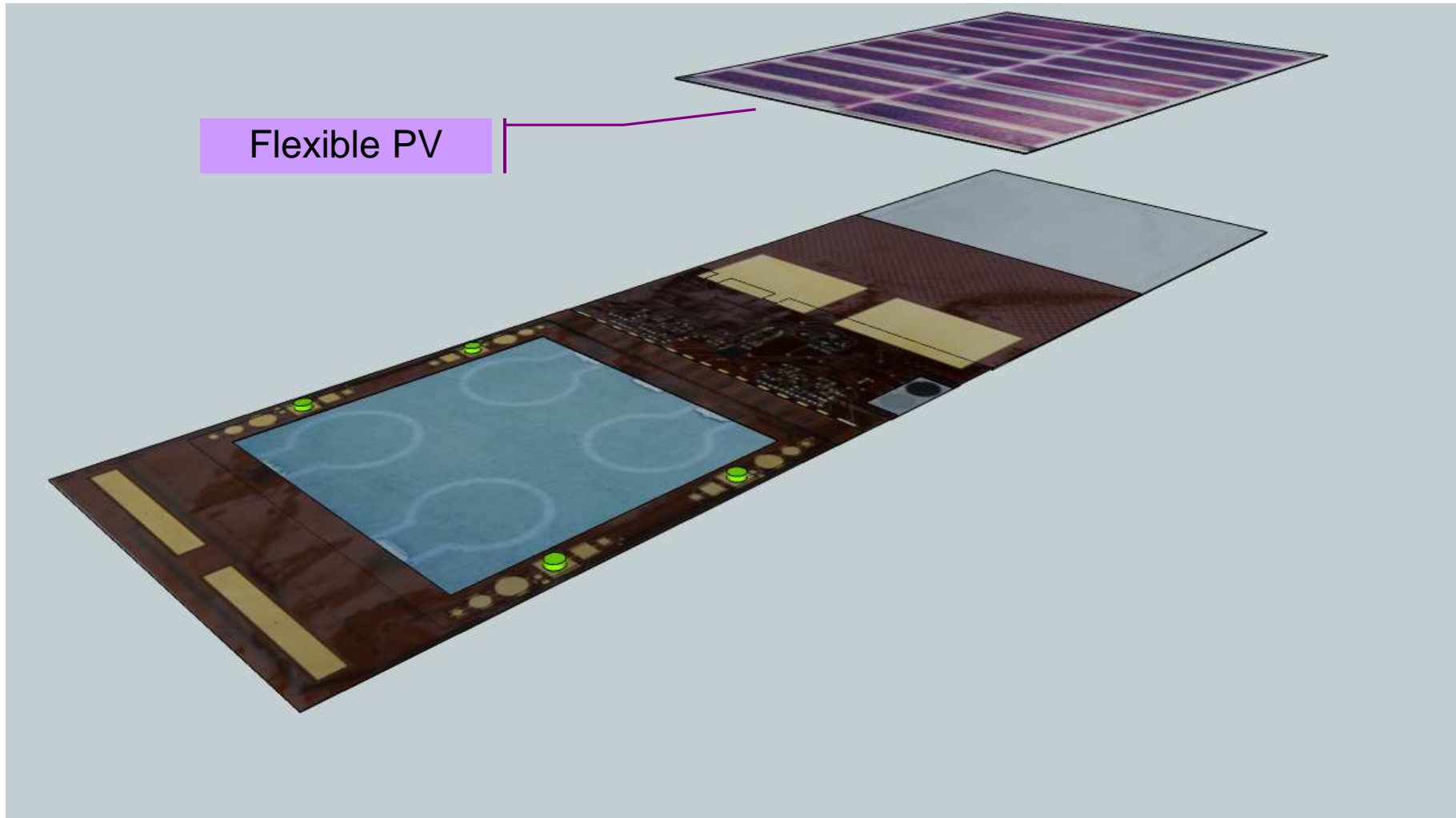

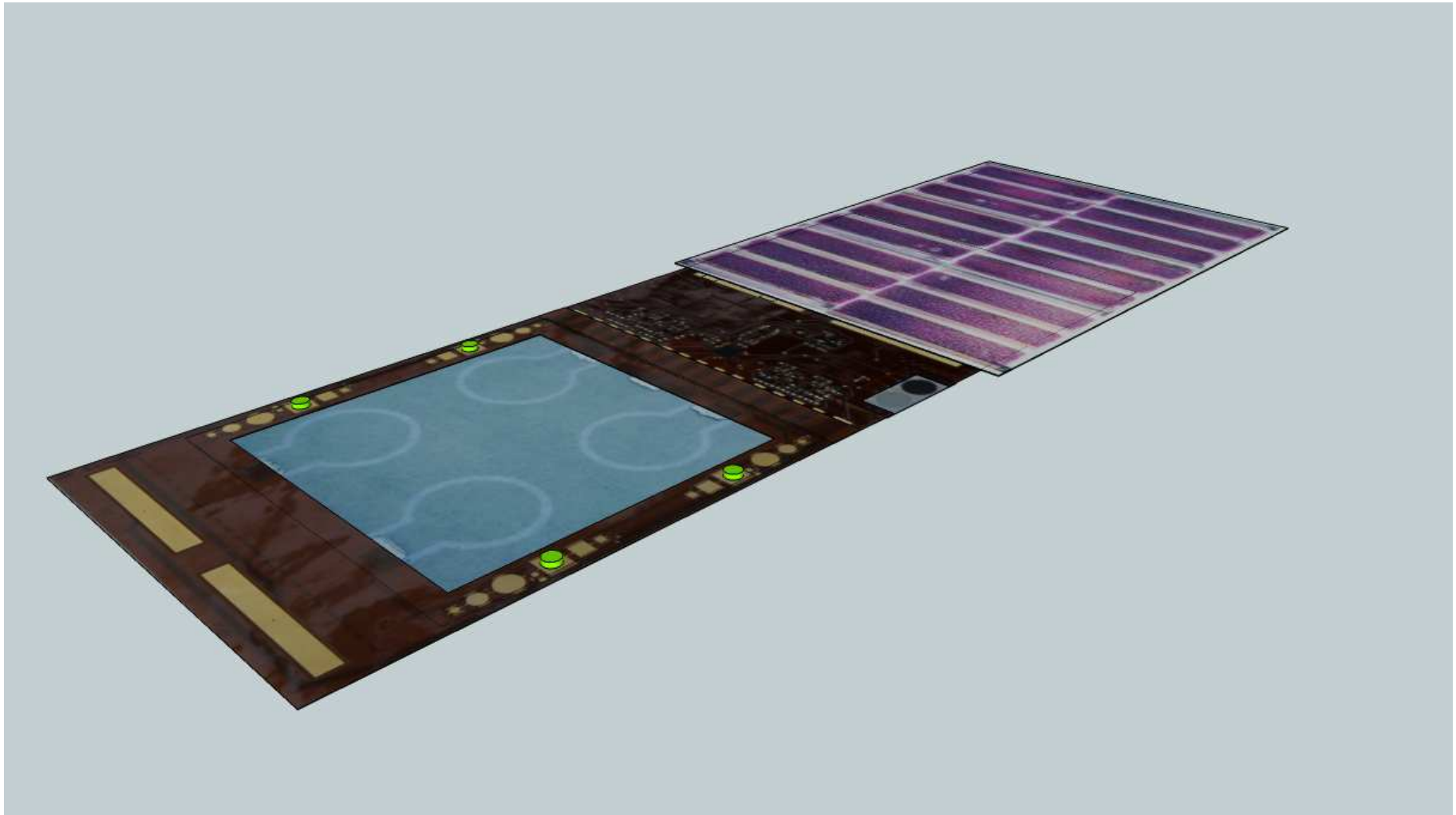

Assembled Flexible Multi-functional Label



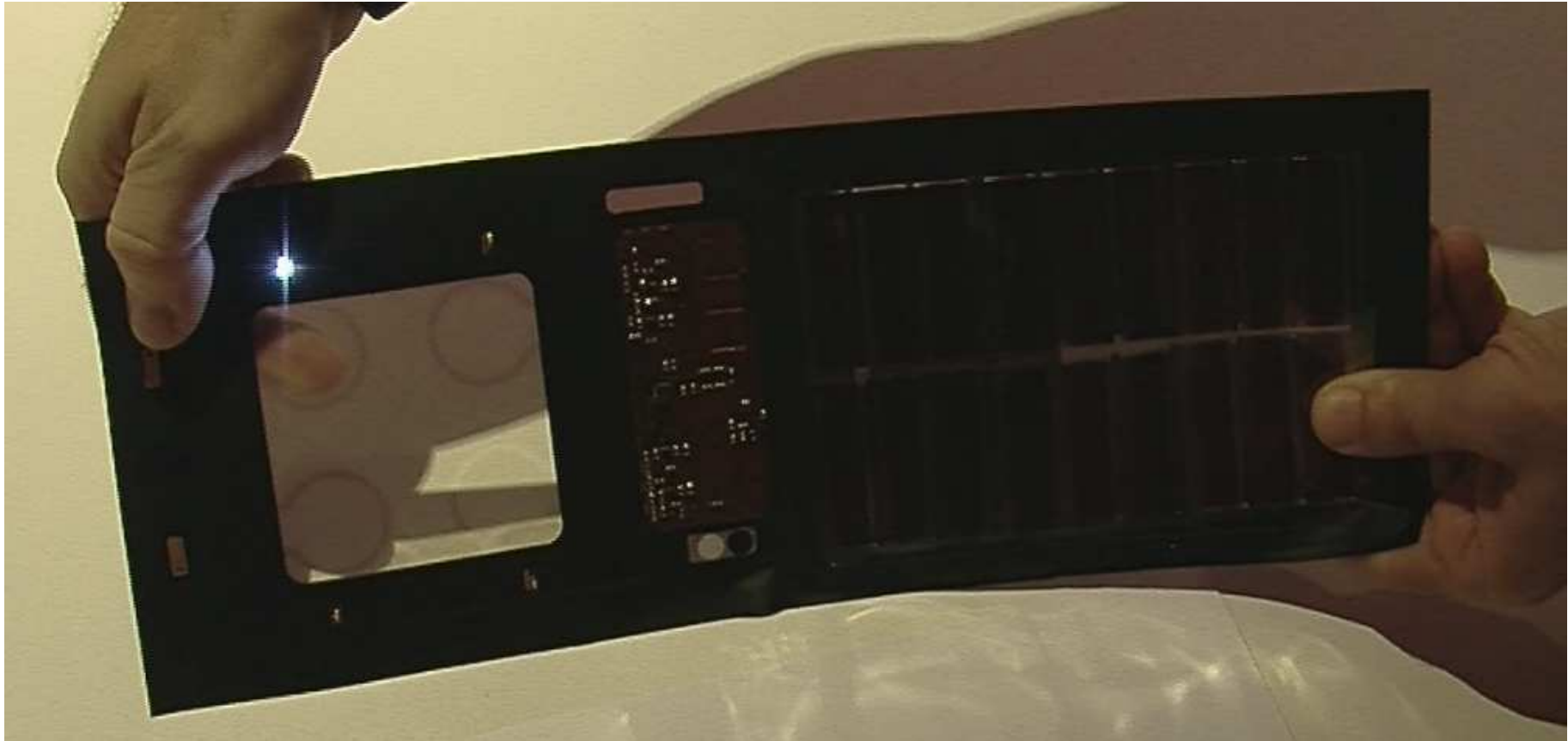

- [Capacitive mode](#) (movie)
- [Temperature alarm mode](#) (movie)
- [Light mode](#) (movie)

- ✓ **1 year project, successfull**
- ✓ **Deadline met**
- ✓ **4 CEA's new techno. integrated**

Since then:

- ✓ **3 startups, 20 patents, numerous H2020 projects + industrial contracts**

More info:

jean-christophe.gabriel@cea.fr

QUESTIONS?



FULLFLEX: WHAT TEAM?

| Component | Investigators | Affiliation |
|--|---|--------------------------|
| Battery (Si NP) | Marc BRESTAZ | DRT/LITEN/DEHT/LCPB |
| | Séverine JOUANNEAU | DRT/LITEN/DEHT/LCPB |
| | Willy PORCHER | DRT/LITEN/DEHT/LCPB |
| | Axelle QUINSAC (NTE) | DSM/IRAMIS/SPAM/EDNA |
| | Yann LECONTE | DSM/IRAMIS/SPAM/EDNA/LFP |
| | Nathalie HERLIN | DSM/IRAMIS/SPAM/EDNA |
| PV organic | Rémi DE BETTIGNIES | DRT/LITEN/DTS/LMPV |
| | Nicolas GAUTHIER | DSM/INAC/SCIB/RICC |
| | Marinella MAZZANTI | DSM/INAC/SCIB/RICC |
| | Daniel IMBERT | DSM/INAC/SCIB/RICC |
| | Renaud DEMADRILLE | DSM/INAC/SPRAM/LEMOH |
| | Amélie REVAUX | DRT/LITEN/DTNM/LCSN |
| LED (NW) | Benoit AMSTATT + François LEVY & Alexandre LAGRANGE | DRT/LETI/DOPT/SCOOP/LCE |
| | Joël EYMERY + Benjamin GREVIN | DSM/INAC |
| Transparente Electrode (CNTs or NW) | Eléonore MOREAU | DRT/LITEN/DTNM/LCRE |
| | Jean-Pierre SIMONATO + Caroline CELLE | DRT/LITEN/DTNM/LCRE |
| | Benjamin GREVIN + | DSM/INAC |
| | Renaud DEMADRILLE | DSM/INAC |
| Printed Electronics | Abdelkader ALIANE | DRT/LITEN/DTNM/LCEI |
| | Romain COPPARD | DRT/LITEN/DTNM/LCEI |
| System /integration | Jean-François MAINGUET | DRT/LETI/DSIS/SIPP |
| | Tristan HAUTSON | DRT/LETI/DSIS/SIPP |
| | Pascale RIVIER | DRT/LETI/DSIS/SIPP |
| Pilotage | Jean-Christophe GABRIEL | DSM/DIR/DPNS |
| | Norbert DANIELE | DRT/LETI/DSIS/SIPP |
| | Tiana DELHOME | DRT/LETI/DSIS/SIPP |