



HAL
open science

Virtuose 6D: A new force-control master arm using innovative ball-screw actuators

Philippe Garrec, Jean-Pierre Friconneau, François Louveaux

► **To cite this version:**

Philippe Garrec, Jean-Pierre Friconneau, François Louveaux. Virtuose 6D: A new force-control master arm using innovative ball-screw actuators. ISR 2004 - 35th International Symposium on Robotics, Mar 2004, Villepinte, Paris-Nord, France. cea-01174924

HAL Id: cea-01174924

<https://cea.hal.science/cea-01174924>

Submitted on 12 Apr 2021

HAL is a multi-disciplinary open access archive for the deposit and dissemination of scientific research documents, whether they are published or not. The documents may come from teaching and research institutions in France or abroad, or from public or private research centers.

L'archive ouverte pluridisciplinaire **HAL**, est destinée au dépôt et à la diffusion de documents scientifiques de niveau recherche, publiés ou non, émanant des établissements d'enseignement et de recherche français ou étrangers, des laboratoires publics ou privés.

See discussions, stats, and author profiles for this publication at: <https://www.researchgate.net/publication/280667300>

Virtuose 6D: A new force-control master arm using innovative ball-screw actuators

Article · March 2004

CITATIONS

23

READS

332

3 authors, including:



P. Garrec

Atomic Energy and Alternative Energies Commission

33 PUBLICATIONS 364 CITATIONS

SEE PROFILE



J-P. Friconneau

Atomic Energy and Alternative Energies Commission

69 PUBLICATIONS 604 CITATIONS

SEE PROFILE

Some of the authors of this publication are also working on these related projects:



IO-Diagnostics Engineering Support [View project](#)



Force controlled arm exoskeleton ABLE [View project](#)

VIRTUOSE 6D: A NEW FORCE-CONTROL MASTER ARM USING INNOVATIVE BALL-SCREW ACTUATORS

Philippe GARREC, Jean-Pierre FRICONNEAU, François LOUVEAU

CEA-LIST

Service de Robotique et de Systèmes Interactifs
BP 6, 92265 Fontenay-Aux-Roses Cedex FRANCE
Contact : e-mail: philippe.garrec@cea.fr

1. Introduction

In this paper, we describe an innovative tendon-driven electrical master arm intended for teleoperation, the Virtuose 6D. This is the first force-control master arm actuated by reversible power screws and cable transmissions. It was first showed at the 2001 ANS exhibition in Seattle, WA., USA.



Figure 1 – Virtuose 6D master arm prototype constructed in 2001 by CEA

The arm itself is issued from a commercially available telemanipulator (MA30 La Calhène) driven by cables and intended to work into glove boxes. Its new motorization unit uses patented ball-screw actuators providing low friction threshold and high reversible efficiency as well as precision combined with a unique longitudinal configuration.

2. Referenced designs for tendon -driven reversible actuation

Historically, the reversible torque amplification-force conversion of tendon-driven actuators has been essentially performed by one of the two referenced principles issued from nuclear teleoperation pioneering teams. The first electrical telemanipulator (E1 model) presented by R. Goertz (ANL) in 1954 was followed by various models ending with the Model E4 (Model M-CRL) in 1965, used gears and cables.

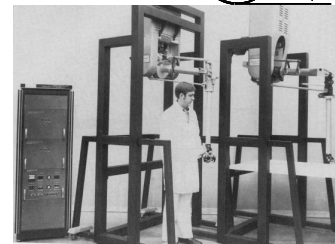
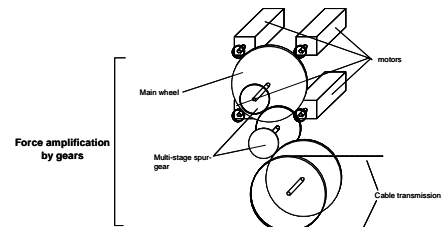

Figure 2 - Key principle of an ANL/CRL Model M actuator

In 1974, the J. Vertut's team (CEA) patented an alternative solution - the block-and-tackle/cable system which produced the serie of MA 23-La Calhène electrical telemanipulators.

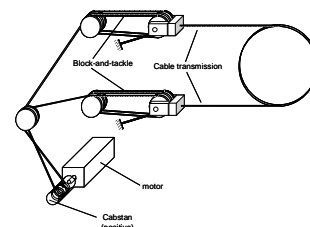

Figure 3 – Key actuator principle of the master arm MA23 CEA/La Calhène

In the end of the 70's, JPL's researchers realized a master arm actuated with a very sensitive device described in

Figure 4. This principle, later developed by Salisbury and Massie (MIT) is at the heart, among others, of the PHANTOM haptic interface (SenSable). Unlike the previous systems this mechanism, based on friction, is not a positive drive.

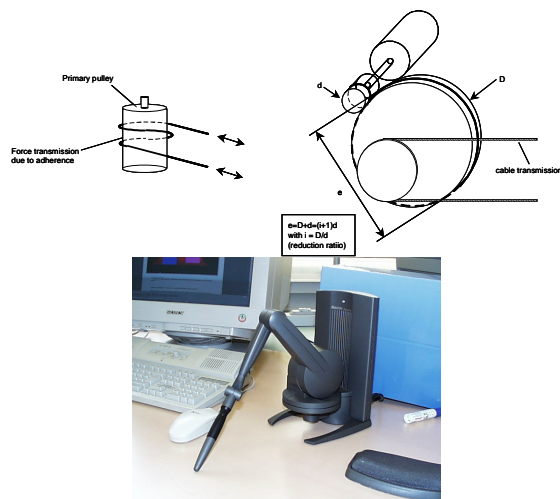

Figure 4 – Capstan design and its application on the Phantom/SenSable haptic device

The gear driven tends to be rather bulky and expensive when constructed with the required qualities unless the size and the capacity of the arm is limited. The block-and-tackle system is more sensitive to fatigue because it uses cables (or tapes) at a high speed. Moreover, its rather complex mounting process is detrimental to maintenance cost. The third system based on friction is additionally limited in terms of effort capacity, drift and fatigue too. Finally, all of them share a common drawback because the motor axis is always transversal to the transmission cable and this factor limits integration possibilities.

3. Development of a new linear actuator

In response to these limitations, we dedicate our R and D effort to use a ball-screw to linearly actuate the push-pull cable loop. It is well-known that such a component presents, by itself, a very low friction compared to its capacity even when back driven. For a sufficient lead angle – typically when the pitch equals the diameter (17°) - the nut is able to move at low speed under a fraction of its weight. In addition ball-screws present a very low stiction and can be fabricated without preload and a negligible play. Experimenting on a THK/BNK1010 model (ground, no preload), 10mm diameter and 10mm pitch, we obtained a friction of approximately 0.6 N for about 2000 N capacity. These results led us to develop a

complete actuator. We consequently devised the following initial design:

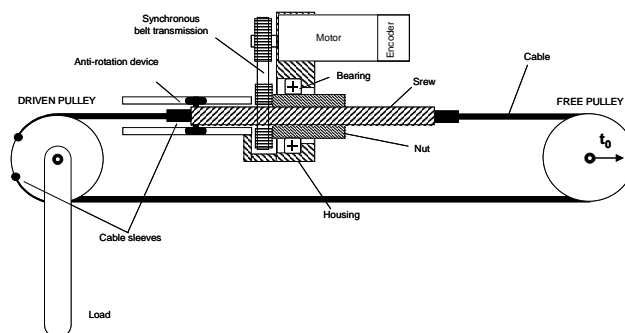

Figure 5 - Initial design of a screw-nut cable actuator

The load is positively driven by a pre-tensioned push-pull cable (t_0). On one side of the loop, the cable is attached to each extremity of the screw. At one extremity, a pair of rollers running in symmetrical slots locks the rotation of the screw on its longitudinal axis (anti-rotation device). A linear force applied on the screw creates a tension difference around the mean value t_0 which, in turn produces an equivalent torque on the driven pulley. There is no linear guiding so as to minimize friction, weight and compactness. The motor is naturally positioned alongside the screw and drives the nut by a synchronous belt.

This principle effectively addresses all of the above-mentioned problems with obvious advantages in reliability and cost as all key components are standard products but its performances proved to be far from sufficient for our application : in the no-load condition, it is easy for an operator to detect friction perturbations depending on the position of the screw, the rotational angle of the nut, and the pre-load of the cable. Friction also significantly increases with the tension in the cable. These perturbations are due to several undesirable tilting moments applied on the nut. Just the tilting moment applied by the cable itself is a potential source of wear and tends to discredit the montage.

Mechanical analysis of perturbations

- Ball-screw kinematical oscillations

From previous experiences in our laboratory, we knew that a ball-screw (or a roller-screw) is affected by kinematics perturbations which can be observed under the following conditions.

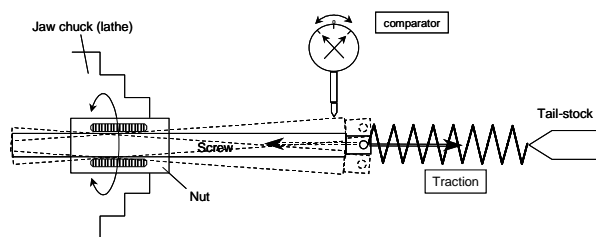

Figure 6 – Parasite conical oscillations of a ball-screw revealed on a lathe

The translation of the screw is affected by conical oscillations centered on the nut axis. This effect could be explained by inequalities of instant speed of the inner components of the nut due to a combination of tiny imperfections in the fabrication process. However we think that to date, no work has been made to model and eventually validate this hypothesis.

In our first design the attachment of the cable at the screw extremity created a variable bending moment between the nut and the screw which in turn produced an irregular friction torque.

This is obviously the case in rigid industrial applications. However friction regularity requirement is usually much less stringent than ours and, in terms of durability, this phenomenon does not seem to be considered critical by constructors as it is never mentioned in their specifications.

- Anti-rotation hyperstasticity

The inherent hyperstasticity due to lateral rigidity of the anti-rotation may create bending moments on the nut depending on the geometrical precision of the screw and of the assembly. This constraint is another source of friction irregularity.

- Cable misalignment

The cable is not rigorously aligned with the nut axis due to fabrication imprecision of cables, sleeves, pulleys, supports, as well as unavoidable deformation of the geometry of the loop when a pre-load is applied.

Description of the definitive design

Then we came up with an improved scheme which ultimately proved to be satisfactory and as such was patented. The following figures explain how this new mounting virtually eliminates irregular bending moments on the nut and therefore guarantees a regular friction in all

configurations. We can arguably claim that we have created a new referenced design.

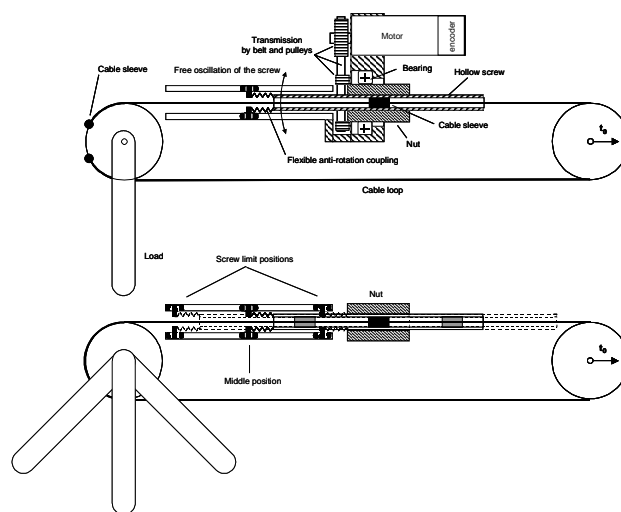
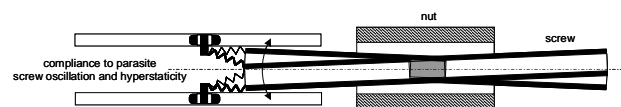
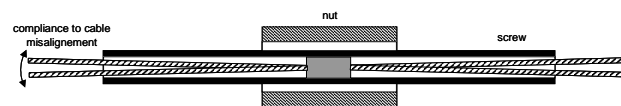

Figure 7 – Final design for the Virtuoso 6D master arm (CEA patent: EUR 01938347.0-2421-FR0101630)

- the anti-rotation is now built with a flexible coupling to allow transversal motions of the screw extremity in both directions. Reactions to screw oscillations and to misalignment of the anti-rotation slots are drastically reduced.



- the cable is attached to the screw with a single sleeve in the nearby of its middle part thanks to a hollow path. The lateral play between the cable and the screw provides a tolerance to mounting precision and deformation under load as well as to screw oscillations.



Friction measurements

Our measurements are performed at a low speed because:

- viscous friction effect is greatly reduced by the efficiency of the controller compensation.
- the stiction is very low.

In Figure 8 we see the basic test-rig used for measurements. It appeared to be very sensitive regarding our application. Any perturbation of the friction produces a change in the speed of the counterweight. The ball-screw used is the same THK model BNK1010 (ground)

with a 10mm diameter for a 10mm pitch (“square pitch”). The drilling operation has been realized in our laboratory with basic tools. The resulting radial expansion, a few micrometers, has no significant effect here.

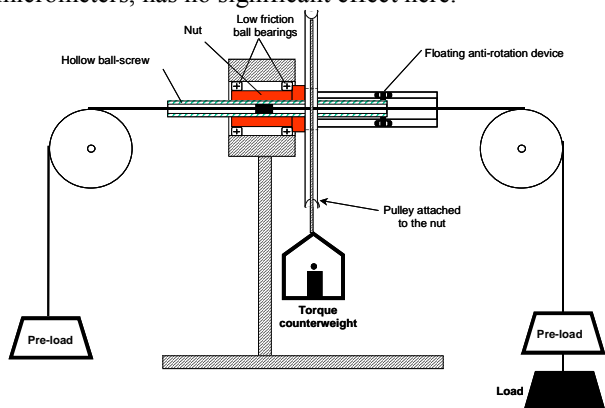

Figure 8 - Test rig used to measure friction in a ball-screw-cable transmission

The resulting performances are summarized in the following diagrams.

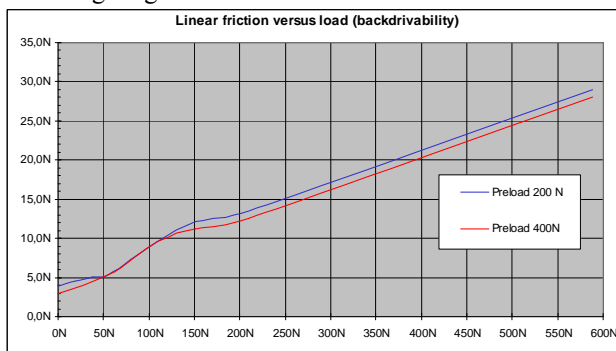

Figure 9 - Friction versus load at low speed

The Figure 9, indicates the friction to torque diagram. The no-load starting force totalizes 3 to 4 N (compared to 0.6 N for our free ball-screw). This value is considered representative because it includes the friction of the nut bearings, the anti-rotation device, the pulleys and residual flexion friction in the cable. It should be compared to the static capacity of the screw which is about 2000 N. The relative global friction of the actuator, 0.2 %, is still very low so only one model of screw needs to be used for various actuator requirements. We also observe that the influence of the tension in the cable is negligible.

The curves in Figure 10. express, on a single diagram, the quasi-static efficiency of both direct and reverse conversion for a 400 N pre-load (arrows). The difference with the theoretical straight line directly expresses the amount of losses due to the load.

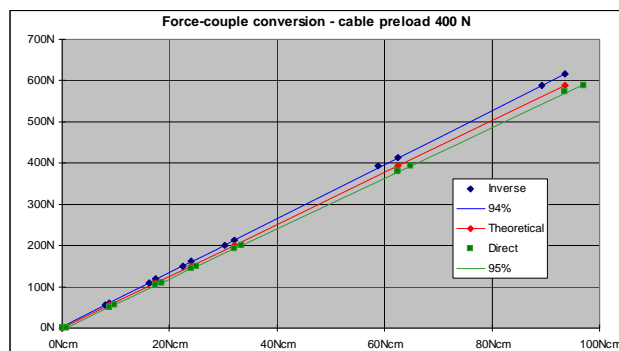

Figure 10 – Force-torque conversion curves at low speed

Direct and inverse quasi-static efficiency are almost equal (94 to 95%) so that the transmission can be considered as fully symmetrical.

4. Virtuose 6D master arm

Arm architecture

The prototype is composed of a 6 axis tendon-driven existing telemanipulator (La Calhène MA30) equipped with a handle lever (for the control of a gripper) and a motorization unit composed of 6 actuators of the above design, completed with a motor controlling the handle lever.

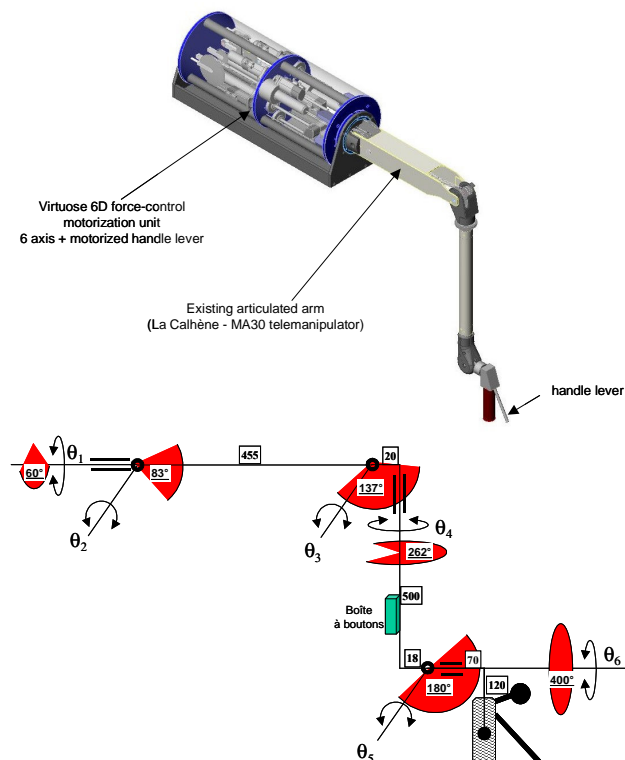

Figure 11 - Virtuose 6D prototype and its d.o.f

Actuators and motorization unit design

Each actuator is mechanically identical, the stroke and the reduction ratio excepted. The cable unit can easily be replaced without dismantling the actuator itself due to a careful detailed design of sleeve attachment. The components used – ball-screw, synchronous belts and aeronautic cable transmission – are well-known standard industrial products.

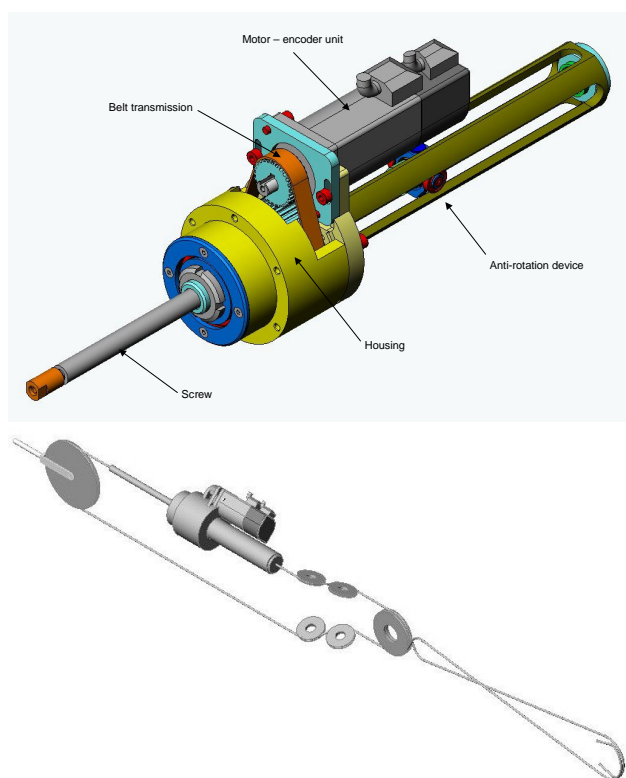

Figure 12 – CAD view of Virtuose 6D actuator and a complete articulation transmission

The longitudinal actuator morphology enables an integration of 7 units within a very compact cylindrical unit at the base of the arm (260 mm overall diameter), which is articulated on its longitudinal axis (Figure 13).

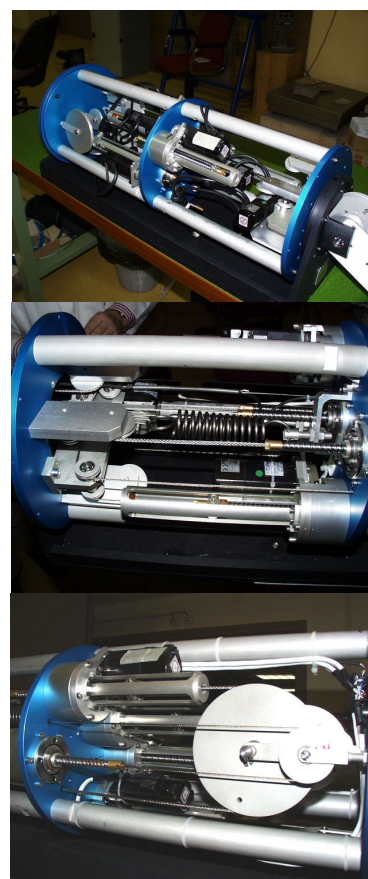

Figure 13 –Virtuose 6D motorization unit (top), front compartment (middle), rear compartment (bottom)

The limited influence of load on friction (5%) allows to compensate gravity with the motor torque and avoids the inconveniences of counterweights and remains undetectable by the operator. On the θ_2 axis however, a coil spring maintains a mid-stroke resting posture of the first segment allowing for a partial mechanical balance. The absence of counterweights leads to a very low inertia on the first three axis. This effect is particularly spectacular on the first axis in spite of the moving mass of the motorized unit (to be compared with the opposite options on the previous MA23 in Figure 3).

The performance level in torque/inertia of recent motors (here a Yaskawa brushless), allows much greater reduction ratios in comparison with previous referenced designs (5 times greater than the MA23 on the first axis). This favorable factor allows a reduction of the size of the motor for a comparable capacity, inertia, and friction.

All these factors contribute to a very compact lightweight master arm with a low inertia on the translation movements.

5. Industrialization

The CEA has designed an improved version of the prototype named Virtuose 6D4040 currently industrialized by HAPTION™. The main evolution concerns the actuators, which now identical with the same stroke thanks to a new design of the cable transmissions. Their stiffness has been also improved. Reduction values have been slightly revised by changing the belt ratio. The maintenance is even simplified thanks to a careful detailed design.



Figure 14 - The author in the company of the first industrialized Virtuose 6D4040 (Haption™)

Virtuose 6D4040 Haption™ main specifications

• Apparent mass	<2,2 kg
• Working volume :	400 mm cube
• Continuous force feedback	
- Translation	40 N
- Rotation	2 N.m
• Position resolution	
- Translation	0,02 mm
- Rotation	0,1 milliradian
• Friction (translation)	1,5 to 3 N
• Total mass of the arm	37 kg

6. Conclusion

The development of the force control master arm Virtuose 6D led to create a new reversible linear cable actuator that arguably challenges existing referenced designs. The industrial version, Virtuose 6D4040, will equip new teleoperation systems currently under development in the French nuclear industry. It is a compact lightweight and

reliable system and its maintenance cost will be extremely low.

Furthermore, many other applications of this actuator are envisioned in the growing field of force feedback systems wherever reversibility, ruggedness and compactness are required at a reasonable cost. Even its key component – a ball-screw – costs no more than a special ball bearing. Moreover, the same basic mechanical design apply to various scale of mechanism can be easily adapted to the needs by replacing a few parts. Several other projects using this technology are currently under development in our laboratory.

7. References

- [1] Garrec P. "Systèmes mécaniques » in : Coiffet. P et Kheddar A., Téléopération et télérobotique, Ch 2, pages 40 to 71, Hermes, Paris, France, 2002.
- [2] Friconeau J.P., Karouia M., Gosselin F., Gravez Ph., Bonnet N., Leprince P., " Force feedback master arms, from telerobotics to robotics surgery training," in *Proc.of CARS*, Paris, 2002, pp31-36.
- [3] Friconeau J.P., Garrec P., Gosselin F., Riwan A., "Status and Trends in Force Feedback Master Arms at CEA", in *Proc of IARP*, Nov 2002
- [4] Dombre E., Modélisation et commande des robots, *Traité des nouvelles technologies, série Robotique*, Hermes, Paris, France, 1998.
- [5] Slutski L.-I., Remote manipulation systems Quality evaluation and improvement, vol. 17 de *Microprocessor-Based and Intelligent Systems Engineering*, Kluwer Academic, Publishers, Dordrecht - The Netherlands, 1998.
- [6] Salisbury J. K., Massie T. H., "The PHANToM Haptic Interface : a device for probing virtual objects", *Proc. of the ASME Winter Annual Meeting, Symposium on Haptic Interfaces for Virtual Environment and Teleoperator Systems*, Chicago, November 1994.
- [7] Vertut J., Coiffet P., Téléopération. Evolution des techniques, vol. 3A, Hermès, Paris, France, 1984.
- [8] Köhler G.-W., Manipulator Type Book, Verlag Karl Thiernig, München, 1981.