

Commissariat à l'énergie atomique

e-den

A Nuclear Energy Division  
Monograph

# Treatment and recycling of spent nuclear fuel

Actinide partitioning – Application to waste management



EDITIONS  
**LE MONITEUR**



---

## DEN Monographs

A Nuclear Energy Division Monograph  
Commissariat à l'énergie atomique,  
91 191 Gif-sur-Yvette Cedex (France)  
Phone: + 33 (0)1 64 50 10 00

### Scientific Committee

Michel Beauvy, Georges Berthoud, Mireille Defranceschi,  
Gérard Ducros, Yannick Guérin, Christian Latgé, Yves Limoge,  
Charles Madic, Philippe Moisy, Gérard Santarini, Jean-Marie  
Seiler, Pierre Sollogoub, Étienne Vernaz, Research Directors.

**Topic editor:** Michaël Lecomte

### Contributors to articles in this Monograph:

Eric Abonneau, Pascal Baron, Claude Berthon, Laurence Berthon,  
Alain Béziat, Isabelle Bisel, Lucie Bonin, Emilie Bossé, Bernard  
Boullis, Jean-Charles Broudic, Marie-Christine Charbonnel,  
Nathalie Chauvin, Christophe Den Auwer, Binh Dinh,  
Jean Duhamet, Jean-Michel Esclaine, Stéphane Grandjean,  
Philippe Guilbaud, Denis Guillaneux, Dominique Guillaumont,  
Clément Hill, Jérôme Lacquement, Michel Masson, Manuel  
Miguirditchian, Philippe Moisy, Michel Pelletier, Alain Ravenet,  
Christine Rostaing, Vincent Royet, Alexandre Ruas, Éric Simoni,  
Christian Sorel, Aimé Vaudano, Laurent Venault, Dominique Warin,  
Alain Zaetta.

**Executive Publisher:** Philippe Pradel.

**Editorial Committee:** Bernard Bonin (Editor in chief),  
Bernard Bouquin, Martine Dozol, Michaël Lecomte, Alain Forestier

**Manager:** Fanny Bazile

**Editor:** Jean-François Parisot.

**Layout:** Pierre Finot.

**English translation:** Jean-François Roberts

**Correspondence:** all correspondence to be addressed to  
the Editor, or to CEA/DEN, Direction scientifique, CEA Saclay  
91 191 Gif-sur-Yvette Cedex (France).  
Phone: + 33 (0)1 69 08 16 75

© CEA Saclay and Groupe Moniteur (Éditions du Moniteur),  
Paris, 2008

ISBN 978-2-281-11377-8

ISSN pending

All information contained in the present document may be freely  
reproduced, in whole or in part, subject to agreement by the editors  
and mention of the source.

**Cover:** Nicolas Poussin, *The Abduction of the Sabines*  
(*L'Enlèvement des Sabines*) (1637–1638). Musée du Louvre,  
Paris (all rights reserved).

Commissariat à l'énergie atomique

e-den

A Nuclear Energy Division  
Monograph

# Treatment and recycling of spent nuclear fuel

Actinide partitioning – Application to waste management

*This Monograph is dedicated to the memory of Charles Madic (8 August 1942–1 March 2008), a research scientist of world renown, who stood behind some major advances in the field of actinide partitioning.*

**C**harles MADIC devoted his life, as a research scientist, to the service of radiochemistry, and the physicochemistry of actinides, in particular those present in spent nuclear fuel. After brilliantly completing his studies at the Science Faculty, Paris University (subsequently Paris-VI University), crowned by a PhD (1967), Charles Madic started on his career at CEA (1969), ultimately being awarded a State Doctor's degree in Physical Sciences (1975), for his work on "The influence of the addition of carboxylic acids on the extraction of actinides by triethylamine nitrate." From the start of his research work at the CEA research center at Fontenay-aux-Roses, near Paris, he became interested in the issues raised by the chemical separation of actinide elements, and fission products, both with regard to fundamental research, and applications for the purposes of radionuclide preparation, and purification. This time in his life, particularly full and intense as it was, gave Charles Madic a grounding in the more complex aspects of fuel cycle chemistry, which was to enable him, throughout his career, to pursue a very broad range of activities. In the field of spent fuel treatment, his work made possible, on the one hand, development of the oxidizing dissolution process for plutonium oxide, and, on the other hand, the condensing into a single step of the partitioning of uranium, and plutonium. This work yielded the processes currently used at the La Hague (France) plant. In the field of radioactive waste management, his work led to the separation processes for americium, and curium which presently stand as the reference processes, being considered for the purposes of the future transmutation of these radioelements.

His range of expertise, and visionary turn of mind led him, under the aegis of the French Act of 1991 on radioactive waste management research, to set up a community of physical chemists, within the PRACTIS research group (1995), which brought together about a hundred research scientists, investigating the properties of actinides, and other radioelements in solutions, and at interfaces. Through the impulse he gave to this group, Charles Madic



made a decisive contribution to the renaissance of pyrochemistry studies in France, the use of synchrotron radiation to probe actinide compounds, and the coming together of theoretical physical chemists, and experimental radiochemists, to bring about a consistent approach to enhanced partitioning, reaching beyond uranium and plutonium separation, to achieve that of neptunium, americium, and curium.

On the European scene, Charles Madic made his mark as a natural leader of research programs for the development of new enhanced partitioning processes.

He thus acted as coordinator, successively, of the NEWPART (1996–1999), PARTNEW (2001–2003), and EUROPART (2004–2007) programs, disseminating his knowledge, and strategic vision, bringing together the work of some thirty research organization across Europe, and making possible the carrying forward of a collective enterprise, outstanding in its breadth, and the quality of its results. This is how the remarkable properties were discovered, and put to use, of polynitrogen ligands of the bis-triazinyl pyridine family, for the selective separation of trivalent actinides.

As the author of more than 170 publications, and 11 patents, his work on the chemistry of actinides earned him the award of the Ivan Psychès Prize, by the French Académie des Sciences, in 2005.

As a research director at CEA, and a professor at the French National Institute for Nuclear Sciences and Technology (INSTN), Charles Madic left his imprint on an entire generation of research scientists, imparting to them his enthusiasm, and his passion for scientific research, through his oversight of numerous PhD dissertations, and his teaching activities.

Charles Madic will remain, in the memory of his colleagues, as an altogether remarkable person, in terms of his personal, human qualities, and as an exceptional research scientist, as witnessed by his scientific influence.

**Robert GUILLAUMONT,**  
*of the Académie des Sciences,*  
**Philippe PRADEL,**  
*CEA, Nuclear Energy Division*

## Foreword

**A**fter getting off to a headlong start in the 1950s, when, for many, it embodied the hope of an inexhaustible source of energy, at a competitive cost, nuclear energy experienced, in the 1980s and 1990s, rejection by the majority public opinion, in a number of countries, in North America and Western Europe, followed by an abrupt check to its growth, and development.

Indeed, while the oil crises of 1973 and 1979 had heralded the launch of massive equipment programs, in a few countries hit heavily by the cost of oil imports – such as France, and Japan – they were paradoxically followed by a halt in investments in nuclear energy, in the United States initially, then in Western Europe. And yet, the strained oil markets that had prevailed only just recently, along with the first concerns as to a possibly impending depletion of natural resources should, by contrast, have bolstered such investments.

The reason for this interruption are doubtless manifold, though it was in part accounted for by the accidents at Three Mile Island, in 1979, and Chernobyl, in 1986, which made a considerable impact on public opinion. At the same time, pro-ecology movements, and the Green parties took up opposition to nuclear energy as one of the mainstays of their programs, widely echoed in this by the media.

In France, whereas the siting of nuclear power plants had – with one exception – never aroused much debate in the population, a mood of rejection emerged in the late 1980s, with the issue of nuclear waste. Faced with the increasing obstruction encountered by the French National Agency for Nuclear Waste Management (ANDRA), in its search for a site for an underground laboratory, the Government of the time decided to discontinue work on the operation, institute a one-year moratorium, and submit the issue to the Parliamentary Office for the Evaluation of Scientific and Technological Options (OPECST: Office parlementaire d'évaluation des choix scientifiques et technologiques).

By adopting most of the Parliamentary Office's recommendations, in particular the specification of a diversified research program, but equally with the initiation of a democratic debate, involving the populations concerned, the Act of 30 December 1991 on nuclear waste management greatly contributed to taking the heat out of the argument. Now, while it is nowadays generally agreed that long-term management of existing nuclear waste is a requisite, continuation of the French nuclear power plant program is still far from being assured: thus, the French Energy Act of 13 July 2005 simply stipulates that "the nuclear energy option is to be kept open up to 2020".

And yet, the coming century should involve the collective realization that meeting the energy needs of our generation may not be contemplated without taking on board respect for the environment, and preserving the rights of future generations to cover the selfsame needs. This is the concept of sustainable development, which our society, inescapably, will have to face up to.

The anthropic origin of global warming, due to the considerable increase in greenhouse gas releases, is no longer put in doubt nowadays. Only the consequences of that warming are still a subject for debate. Industrialized nations, being largely the root cause of the present situation, hold a particular responsibility, which should act as an incentive for them to

curb, in proactive fashion, emissions of such gases. Nuclear energy, exempt as it is, by its very nature, from this kind of emission, while having the capability to provide energy that is relatively plentiful, reliable, and economically competitive, should by rights be widely taken up.

The position in this respect is contrasted, across the world. On the one hand, some European countries, as Germany, or Belgium, have opted to phase out gradually the use of nuclear energy, even though no reversibility has been provided for, in this respect. On the other hand, countries such as China, South Korea, and, closer to France, Finland are investing heavily in development of this technology. At the same time, according to a recent statement by President George W. Bush, the United States are determined to launch, before the decade is out, programs for the construction of new nuclear power plants, a process that had been in abeyance for over 25 years.

In France, following the national energy debate, held in the first semester of 2003, the Strategic Orientation Act on energy, passed in June 2005, sanctioned the decision to build an EPR demonstrator reactor, to lay the ground for replacement of the power plants currently in service.

A number of signs are thus indicating that the “renaissance” of nuclear energy may be at hand, particularly if oil prices persistently remain pegged at levels of USD 70 per barrel, or more. Be that as it may, the future of nuclear energy, in France as in other countries, will largely depend on its ability to address, in requisite fashion, the two following concerns:

- the first concern has to do with social acceptance; it is essential that use of nuclear energy take place in optimum safety and security conditions, yielding a minimum amount of ultimate waste, while such waste must be perfectly controlled, in terms of its possible impact on health, and the environment;
- the second concern involves availability of resources; it is crucial that fuel supplies be guaranteed over the long term, by laying the ground for a switch to technology lines ensuring a better husbanding of natural fissile material, and, most importantly, less affected by market fluctuations.

These issues stand at the core of the remits CEA's Nuclear Energy Division is charged with. Indeed, the Division stands as a major player, in research work aimed at supporting the nuclear industry, with improvements in reactor safety, and competitiveness; providing the French Administration with options, regarding long-term nuclear waste management; and, finally, developing the nuclear systems of the future, chiefly fast-neutron reactors, affording highly promising improvements in terms of waste management, and raw material utilization.

As a staunch supporter of efforts to ensure the widest possible dissemination of scientific and technological knowledge, it strikes me as being of the utmost importance that such research work, drawing as it does on a wide spectrum of scientific disciplines, and often ranking as among the best of its kind worldwide, be set out, and explained to all those who wish to make up their own minds, regarding nuclear energy. Which is why I salute, with deep-felt satisfaction, the publication of these DEN Monographs, careful perusal of which will undoubtedly provide an incomparable wealth of information for their readers, of which, I hope, there will be many.

My thanks go to all those, researchers and engineers, who, through their contributions to this survey, have taken pains to share their experience, and knowledge.

Bernard BIGOT  
High Commissioner for Atomic Energy



## Actinide partitioning: a major building block for sustainable nuclear energy

The fuel used in current nuclear reactors consists of uranium oxide, or a blend of mixed uranium and plutonium oxides. Subsequent to its dwell time in reactor, such fuel still bears a substantial amount of recoverable materials, for value-added purposes, which it is of advantage to recover. At the same time, the energy-yielding nuclear reactions have also yielded further elements, to wit **fission products\***, and minor **actinides\***, making the spent fuel highly radioactive. That is why such fuel is subjected to treatment, in order to:

- partition the materials that are to be recycled from other radioactive elements, making up the waste;
- condition that waste into a form that is inert, and safe.

Actinide partitioning forms a crucial component in the **nuclear fuel cycle\***. This issue has loomed large, over the past decade or so, its extensiveness stemming both from the challenges to be met – which are considerable – and the rich, complex character of the media in which such a separation, or rather such separations, have to be carried out, entailing that the science and technology involved are uncommon indeed.

So-called “spent” **nuclear fuel\*** exhibits, subsequent to its in-reactor dwell time, an extremely wide variety: transformation of the initial uranium (or plutonium), owing to nuclear **capture\*** or **fission\*** reactions, results, indeed, in the formation of radionuclides of highly diverse kinds, and properties, in many respects: in terms of physical and chemical properties – the elements thus yielded are spread across all of the columns in the periodic table – but equally as regards their potential for further value-added energy use, or radiological harmfulness.

Within that extensive array of elements, **actinides\*** hold a remarkable position. So-called “**major**” **actinides\***, first of all, these being the most abundant elements in spent fuel: uranium still accounts for 95%, and plutonium for about 1%, by mass, in “standard” water-reactor fuel, as discharged. The **fissile\***, or **fertile\*** character of these nuclei is what makes their recovery advantageous, for **recycling\*** purposes. At the same time, *plutonium* is, of the various elements present, the chief contributor (by far) to the long-term radiotoxicity exhibited by spent fuel. As for so-called “minor” actinides (*neptunium*, *americium*, *curium*), while only accounting for one thousandth of its mass, these stand – once plutonium has been removed – as the chief component in that fuel’s residual harmfulness, after a few centuries. Actinide partitioning may thus – aside from the benefits it affords in energy terms – open the way to

differentiated management modes, as the deployment of actinide **recycling\*** options may contribute to a downsizing of ultimate waste, in volume terms obviously, but equally in terms of toxicity (the more so the more “advanced” the recycling options).

The quest for actinide separation processes, and technologies, to serve a variety of spent nuclear fuel management strategies, has thus stood as a major area of investigation, for more than half a century. The **PUREX\*** process, allowing as it does the recovery, and recycling of major actinides, by making use of the remarkable properties, in terms of selectivity (and stability), of an organic molecule, tributyl phosphate (**TBP\***), has seen widespread success, from the initial pilot facilities set up in the 1950s, culminating, at the turn of the 1990s – drawing on 40 years’ development work – in industrial installations, singularly well thought out, at Areva’s La Hague (France) site (see Fig. 1), and those presently coming on stream at Rokkasho-Mura (Japan). Such installations currently stand, along with the **MOX\*** fuel fabrication plants complementing them, as the acme of the state of the art, as regards uranium and plutonium recycling. Indeed, they make use of a mature, effective technology, and one that is safe, clean, and economically competitive. This has been shown by operational feedback from over 15 years’ operation at Areva’s La Hague and MELOX plants, where several thousand tonnes of fuel, and several tens of tonnes of plutonium have been reprocessed, and recycled, respectively, with recycling rates of some 99.9% achieved, while generating very small amounts of secondary waste – this indeed accounting for the remarkable longevity of the selective extraction concept, which still carries a broad consensus, even as the issue is one of devising more advanced processes for the future.

It is thus feasible, nowadays, to recycle the uranium and plutonium from water reactor fuels, with major benefits accruing: savings in terms of uranium ore resources (up to 20%) and isotopic separation work, a drastic reduction in terms of ultimate waste mass, volume, toxicity, and decay heat, with the ability to immobilize such waste in a suitable matrix (glass), the destruction of fissile plutonium...

This is a crucial point, with the now widely heralded prospect of a “renaissance” of nuclear energy in the offing, involving in all likelihood the discharging, over the coming few decades, of major quantities of spent nuclear fuel, in many countries around the world, which will need to be managed in the most



Fig. 1. The Areva plant, at La Hague (France).

effective, and safe manner. Recycling major actinides, relying as this does on the best technologies available, stands out as a responsible solution for the management issue, by precluding excessive buildup of spent fuel. Further, recycling technology is amenable to yet further improvement: new third-generation reactors, such as EPR, are designed to allow more efficient recycling of plutonium. Such is also the case, however, as regards fuel cycle processes: the **COEX™** concept, allowing the joint management of plutonium and uranium throughout treatment operations, from fuel dissolution to the fabrication of products for recycling, based as it is on the same technologies as the PUREX process, though used in a different way, is liable to bring further significant benefits, through simplified operations, improved fuel quality, and inherently enhanced **proliferation\*** resistance...

One further major challenge is that of developing sustainable long-term strategies. Whether the issue is *optimized conservation of fossil natural resources*, or *minimizing the environmental impact* of such activity, it has become obvious, nowadays, that a sustainable nuclear energy industry may only be one that recycles its own recoverable, and hazardous materials.

*The concept of recycling uranium and plutonium in water reactors, as implemented in France and in other countries, unquestionably stands as a first step in that process. It is a real challenge, however, to turn this into a sustainable option. The issue is not so much that of recovering, in recurrent fashion, plutonium and uranium from fuels undergoing multiple recycling, this being virtually a settled matter; rather, the point is, first and foremost, that of bringing to maturity reactors having the ability to put to the fullest advantage the materials being recycled inside them. The limitations of water reactors, in this respect, are well known, this accounting for the resurgence in interest*

being expressed, in many regions around the world, as regards the development of **fast-neutron reactors\*** (fast reactors), these having the ability, when operated in conjunction with uranium and plutonium recycling technology, to extract 50–100 times more energy, from the same initial amount of natural uranium, than current water reactors are able to. This then is the initial thrust for future developments, providing the essential direction for the Generation IV International Forum: uranium and plutonium recycling in fast reactors. It may be noted, in this respect, that countries such as India are looking into the possibilities for value-added use of their abundant thorium resources, through the deployment of a reactor line effecting the multiple recycling of that thorium, and the uranium **233-isotope\*** it

may yield under irradiation. This is a cycle comparable to the uranium–plutonium cycle, affording some benefits that have been put forward, these however remaining limited, and possibly even counterbalanced by other, less favorable aspects. Such an option is consequently regarded with a somewhat distant interest by those countries that have long since opted for the recovery for value-added purposes of uranium.

*Beyond that initial step, however, providing as it does the main plank for a sustainable nuclear energy development strategy, possible avenues for further advances have already been identified. While, for the purposes of bringing down the long-term potential toxicity of waste, plutonium recycling is indeed the essential step, this may be further reduced through the complementary recycling of minor actinides. This is not, strictly speaking, a safety issue, since it now seems well established that nuclear glasses do form a particularly resistant matrix (alteration, in the steady regime, standing at less than one micron per century), and, more specifically, that **transuranium elements\***, assuming they were released from such a matrix, would exhibit extremely low mobility in the reducing conditions prevailing in **disposal\*** repositories in deep geological formations, as investigated by **ANDRA\***. (The latter point, however, it may be assumed, will need to be investigated on a “case by case” basis, since a disposal concept in oxidizing conditions, such as that investigated in the United States at Yucca Mountain, does show a potential for neptunium migration...) Rather, it is the principle of bringing down the potential harmfulness of ultimate waste (its “intrinsic” **radiotoxicity\***, i.e. independent of the management mode opted for) that acts as the driving force for such investigations. It may thus be shown (with all due caution when making use of such comparisons) that, for the radiotoxicity levels of spent fuel to come down again to that of the uranium used to make it, more than 100,000 years would have to elapse; if the plutonium is extracted, more than*



10,000 years would still be needed; while, if minor actinides are also taken out, that “initial” level would be recovered after a few centuries only...

This is a direction for advances on which there is very broad agreement, having been taken up as it has for over a decade in the programs of European, US, or Japanese laboratories, and forming one of the directions for research specified by the French Act on radioactive waste management research, as adopted by the French Parliament in 1991, and one taken up again by the latest French Act of June 2006 on sustainable radioactive material and waste management: the Act emphasizes the importance of downsizing, as far as feasible, ultimate waste. Thus, the recycling policy implemented to date, in France, is of advantage, first in terms of the results it achieves (particularly in terms of the drastic reduction in ultimate waste volume, and long-term toxicity), but equally in that it brings the ability to open up the way for yet more effective management strategies in the future.

*The recycling of minor actinides is thus a well established avenue for research, however it does involve many options still under investigation, and issues that remain open.*

*Which minor actinides should be recycled? All of them?* Americium, curium, neptunium should conceivably not be seen as forming one, homogeneous block, insofar as the potential harmfulness they involve may vary widely. It is apparent, in particular, that americium is the foremost contributor to waste long-term toxicity (once, obviously, plutonium has been removed), with curium coming second, and neptunium further down still. It is further apparent that the americium-241 isotope is responsible for most residual decay heat after one century, once decay has occurred of the more “heating” curium isotopes, or certain fission products. At the same time, the issues relating to minor actinide recycling are not the same for each of these elements. Thus, recycling americium would seem to raise fewer issues than curium recycling (this being made more difficult owing to the presence of isotope 244, which is highly radioactive, and a very powerful neutron and heat emitter). Which is why, alongside the full actinide recycle option, which had been the main focus of investigations so far, interest is also switching to more readily deployable options, involving the sole recycling (initially?) of americium.

*And in what manner are such minor actinides to be recycled?*

- In a single pass (“once-through” recycling), or over a number of passes (“multirecycling”)?
- As a group, together with major actinides, by diluting them into uranium and plutonium (the so-called “homogeneous recycling” option)?
- Held in specific objects, positioned inside power reactors, i.e. objects used to concentrate minor actinides, and subjected to specific management (so-called “heterogeneous” recycling)?
- Or in objects placed inside specific irradiation devices – such

as accelerator-driven systems – coming under a distinct stratum (the so-called “double stratum” option)?

Here again, all of these options are being investigated, and evaluated.

*Finally, which processes should be used to carry out such separation operations?*

**Hydrometallurgical\*** processes, making use of selective minor actinide **extractants\***, currently stand as the favored research avenue, having been targeted, for over a decade, by a multifaceted research effort, in France, and more widely in Europe, and further around the world, in Japan and the United States.

A number of factors may account for this option being the favored one: first, the “inherent” advantages, as mentioned earlier, afforded by solvent extraction, as regards carrying out such operations on this type of element (performance in recovery terms, low waste yield, along with flexibility with respect to the characteristics of fuels undergoing treatment, or recycling strategies); second, the feasibility of thus complementing extant uranium and plutonium recycling installations (PUREX, and presently COEX™...), thus allowing for a gradual deployment of more advanced options... while using technological setups (the specific liquid–liquid extractors used in nuclear applications) that are already proven on an industrial scale. Actinide separation by the hydrometallurgical route comes under the broad branch of chemistry known as **coordination chemistry\***. This relies on molecules having the ability to bind, selectively, into **complexes\*** with the actinides being separated. Novel molecular architectures have thus been designed, synthesized, tested in the laboratory, and subsequently optimized. These have allowed the development of minor actinide separation processes, such as the **DIAMEX\*** and **SANEX\***

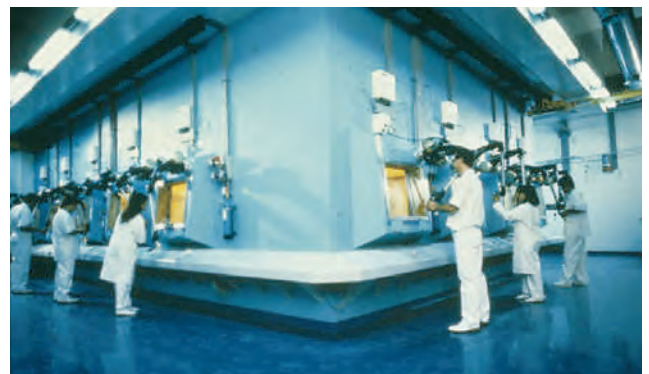

Fig. 2. The ATALANTE facility, at CEA’s Marcoule Center, is a dedicated research and development facility for spent fuel treatment, from fuel dissolution to waste vitrification, including use of radioactive materials. High-performance scientific equipment, for experimental and analytical purposes, is set up in an environment involving containment areas (gloveboxes, shielded cell lines), allowing the investigation of actinide treatment and recycling processes.

processes at CEA, or NEXT in Japan, or UREX in US Department of Energy laboratories. Many criteria must be met, or reconciled, for “candidate” **extractants\*** – selectivity, reversibility, resistance to chemical or **radiolytic\*** aggression from the ambient medium, physical properties, nonhazardous byproducts... – as indeed for the process flowsheets derived from them – recovery rate, purification rate, safety, robustness, deployment costs... – this accounting for the diversity of concepts, and the wide-ranging character of research efforts, in terms both of exploratory and fundamental work. Some crucial aspects, as e.g. selectivity between **actinide\*** and **lanthanide\*** ions, are still currently far from well accounted for, and advances in this area could open up the way to designing new molecules, affording higher performance yet.

Quite major advances have been achieved in the laboratory, over the past few years: the availability has thus been demonstrated, in the **ATALANTE\*** facility (see Fig. 2) – in an experiment involving nearly 15 kg of spent nuclear fuel, using extraction technologies homologous to those in use on an industrial scale – of processes allowing the recovery, for recycling purposes, of americium and curium, with rates of more than 99% achieved. Research work is currently ongoing, seeking to optimize the concept, while further enhancing operation compactness, by simplifying the operations, and developing process “variations,” to suit the various recycling strategies that may be entertained (recovery of americium only; or group recycle of all transuranium elements, with the **GANEX\*** concept).

Alternatives to hydrometallurgical extraction processes are being investigated. In particular, so-called “*pyrochemical*” processes, involving dissolving fuels in high-temperature (500–800 °C) molten salt baths, with subsequent recovery of the elements intended for recycling through electrolysis operations, or extraction operations using liquid metal alloys. Such processes have been experimented with, in Russia or in the United States in particular, where uranium recovery experiments were carried out on a pilot scale with metal fuel. Such concepts are deemed to afford many benefits: compactness in principle, few radiolytic effects (this allowing operations to be carried out immediately after discharge from the reactor...). However, uncertainties do remain, as to process performance in terms of full actinide recovery, and secondary waste yield... Even though, for some fuels, and given certain management options, **pyrochemical\*** processes may indeed afford high potential benefits, it would seem there is still a long way to go for such concepts to be brought from the laboratory to industrial facilities.

*What might the next steps involve?* Actinide recycling is the requisite option, to achieve sustainable nuclear energy, in many respects. One major milestone was reached with uranium and plutonium recycling, for water-reactor fuels, coming to full industrial maturity. While it does appear crucial to carry through along this path, in the coming years, with the deployment of fast reactors making it possible to reap the full potential benefits it affords, it is apparent that more “advanced” options, recycling all or part of the minor actinides, may provide avenues for advances, and these are being targeted by major, active research drives, in many countries. After laboratory investigation and development of such advanced processes, current work involves preparations for the pilot demonstration phase. Owing to the size of the capital outlay required, planning is taking place at the international level, as regards fuel cycle prototypes, and installations that will allow that new stage to be passed.

In the United States, the challenge involved in rational actinide management, as the prerequisite to achieve sustainable nuclear energy, has been fully acknowledged. The issue stands at the core of three initiatives recently launched by that country: Gen IV (for the development of fourth-generation nuclear systems), the International Nuclear Fuel Cycle Evaluation (INFCE) program, and the Global Nuclear Energy Partnership (GNEP), all three being intended to draw together, on the world scene, efforts in that area, while restoring the United States to the forefront of players in the field, after years of absence, as regards development of the nuclear systems of the future, and the fuel cycle back end. The European Union has not lagged behind, with the EUROPART, EUROTRANS, and ACTINET programs, along with the French PACEN (Programme sur l’aval du cycle et l’énergie nucléaire: Cycle Back-end and Nuclear Energy Program) program. France, as a pioneer in the area of actinide partitioning, and recycling, undoubtedly has a major part to play in these research programs, as, more widely, in the development of such technologies around the world.

**Bernard BOLLIS,**  
*Development and Nuclear Innovation Directorate*

## Actinides: a 20th century discovery

**F**or the chemistry of “radiating elements,” the founding myth dates back to 1896, when H. Becquerel reported his findings regarding mysterious radiations emanating from uranium salts – one century after the uranium element had been discovered by M. H. Klaproth, in 1795, and 70 years after the discovery of thorium by J. J. Berzelius, in 1828. From that time on – and indeed starting with the discovery of X rays by W. C. Röntgen, in the preceding year – up to the decade following the Second World War, the chemistry of radiating elements, or “radioelements,” underwent prodigious growth, concomitant with the huge strides made in atomic physics, and quantum physics. It was unquestionably with the work of Pierre and Marie Curie, as reported to the French Académie des Sciences in December 1898 (discovery of radium), and subsequently in January 1899 (discovery of polonium), that the chemistry of radioelements, or radiochemistry, took off, becoming a discipline in its own right.

The concatenation of discoveries, such as the identification of  $\alpha$  and  $\beta$  rays by E. Rutherford, the discovery of spontaneous transmutation by E. Rutherford and F. Soddy (the latter further going on to demonstrate the existence of **isotopes\***), the identification of the neutron by J. Chadwick, the discovery of artificial radioactive isotopes, and transmutation, by I. and F. Joliot-Curie, through to the discovery of atomic fission, in 1938, stand as the milestones of an adventure that remains unparalleled in the 20th century. The turn taken by world events, from 1936–39, proved decisive in shaping the new directions taken

by radiochemistry, and atomic physics. Two key dates, undoubtedly, stand out in the race to atomic power: as early as 1939, the simultaneous discovery, by a number of teams including those of E. Fermi, in New York, and F. Joliot-Curie, in Paris, of the possibility of a fission chain reaction; and, in February 1941, the discovery of plutonium by G. T. Seaborg, at Berkeley, following the discovery by E. M. McMillan, in 1940, in the selfsame laboratory, of the first artificial element, neptunium. Up to that time, the elements thorium, protactinium (discovered in 1917 by O. Hahn and coworkers), and uranium had been inappropriately placed, in Mendeleev’s periodic table of elements (see Fig. 3), below elements hafnium, tantalum, and tungsten respectively.

When CEA was set up, in 1945, at the behest of General de Gaulle, half a century had elapsed since the discovery of radioactivity, even as the issue was becoming that of ushering radiochemistry, and nuclear physics into the age of energy production. A discovery from the final years of the 19th century, then, gaining from tremendous international rivalry – remarkably concentrated in time – and involving strategic, military stakes, up to a recent past, one however that is equally, and most crucially, bound up with energy generation for the present, and the future.

**Philippe Moisy and Christophe DEN AUWER,**  
*Radiochemistry and Processes Department*

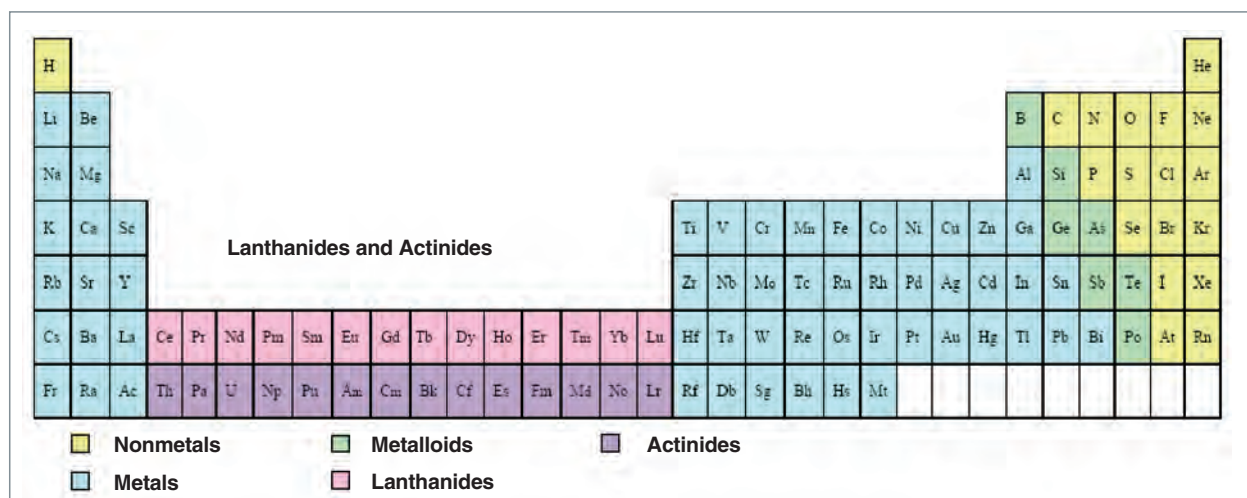

Fig. 3. Periodic table of the elements.



## Radionuclides in nuclear fuels

All actinide **isotopes\*** are unstable naturally, and are so likewise, obviously, when bombarded by beams of particles. As regards major actinides (uranium, plutonium), the isotopes that need to be considered, in the context of nuclear fuel treatment work, are isotopes 235–238, for uranium, and 238–242 for plutonium. All plutonium isotopes, except Pu 241, undergo disintegration through the alpha decay mode. As for the Pu 238 isotope, its especially short (87.8 years) **radioactive decay half-life\*** exacerbates the alpha **radiolysis\*** phenomena experienced during nuclear fuel treatment operations. As regards the Pu 241 isotope, its radioactive decay mode (beta decay), involving as it does a very short half-life (14.4 years), compared to that of other isotopes, results in a buildup of Am 241, a gamma emitter isotope. Consequently, while handling large amounts of purified plutonium is feasible through use of suitable gloveboxes, such is not the case as regards batches of aged plutonium, which become radiation emitters owing to spontaneous “adulteration,” as outlined above.

With respect to minor actinides (neptunium, americium, curium), the isotopes that need to be taken into consideration, first and foremost, in fuel treatment operations, are the Np 237, Am 241, and Am 243 isotopes, along with Cm 242, and Cm 244. Neptunium and americium isotopes exhibit both alpha and gamma decay modes, whereas curium isotopes are chiefly short half-life alpha “emitters,” this indeed resulting in considerable heat release, which must be removed.

For elements of atomic number greater than that of einsteinium (Es,  $Z = 99$ ), available amounts of these materials being insufficient for such measurements, thermodynamic quantities are not known. However, for the lighter elements ( $Z < 99$ ), standard thermodynamic quantities (Gibbs free energy [free enthalpy]  $\Delta G^\circ$ , enthalpy  $\Delta H^\circ$ , entropy  $\Delta S^\circ$ ) have been determined by direct thermodynamic measurements, with great precision. On the basis of these quantities, many calculations may be carried out, to predict the chemical behavior of these elements.

It should be noted that the radioactivity exhibited by these elements (alpha, beta, gamma emissions) is liable to result in substantial alterations in the chemical properties of actinide solutions, owing to **radiolysis\*** phenomena. Thus, due account must be taken of the existence of such species as are liable to be formed, and their buildup, due to radiolysis processes in the medium. By way of example, it is well known that radiolysis of nitric acid results in a buildup, in aqueous

solution, of nitrous oxide, while radiolysis of tributyl phosphate (**TBP\***) – this being the extractant used in the **PUREX\*** process – results mainly in the formation of dibutyl phosphate, or monobutyl phosphate, which must be separated out, to allow the extractant to be recycled, in modern plants.

When subjected to neutron bombardment, the various uranium and plutonium isotopes are liable to undergo transformation, whether through **fission\***, or **capture\***, this yielding, in the former case, a multiplicity of **fission products\***, with an intense release of energy; and, in the latter case, nuclei of greater mass. It may be noted that the U 235 isotope is said to be “**fissile\***,” whereas the U 238 isotope is said to be “**fertile\***,” since it yields, by neutron capture, the various isotopes of plutonium, chiefly the Pu 239 isotope, which is particularly fissile.

Fission of the U 235 isotope, which is very close to that undergone by the Pu 239 isotope, is asymmetrical, yielding fission products with atomic masses exhibiting extrema, with values

### Radiolysis phenomena in the fuel cycle

The radiolysis phenomenon, which is due to interaction between radiation and matter, causes chemical and physical alterations in irradiated media. Owing to the presence of many radioactive species in spent fuels, radiolysis phenomena ( $\alpha$ ,  $\beta$ ,  $\gamma$  radiolysis) occur at every step during treatment.

Thus, radiolysis of aqueous solutions of nitric acid is highly complex. Depending on nitric acid concentration, such radiolysis phenomena ultimately result either in a buildup of dihydrogen peroxide ( $H_2O_2$ ), or of nitrous acid ( $HNO_2$ ) along with nitrogen oxides ( $NO_2$ ,  $NO$ ). The redox behavior of the constituents of the fuel dissolution solution, particularly that of actinides, is thus chiefly governed by these species. Likewise, the solvent used in the liquid–liquid extraction steps may undergo partial degradation under the action of radiation, and the degradation products formed will affect the chemical behavior of the metal cations yielded by dissolution of the fuel. The sensitivity to radiolysis of extractant molecules is one of the parameters that must be taken into account, when evaluating the performance of the new extractants being considered for minor actinide (Am, Cm) separation.

close to 100, and 140. In the periodic table, elements of atomic mass around 100 belong to the platinoid family, further including certain isotopes of strontium, zirconium, and technetium, while those of mass around 140 belong to the lanthanide family, along with certain isotopes of cesium, iodine, and xenon. The composition of spent fuel dissolution solutions is made highly complex, owing to the diversity of elements present, and their respective concentrations.

**Philippe Moisy,**

*Radiochemistry and Processes Department*

## Actinide aqua ions

The actinide (An) family starts with thorium ( $Z = 90$ ), and ends with lawrencium ( $Z = 103$ ). These elements are seen as forming an inner transition series, corresponding to the filling of subshell 5f. Since they were discovered, these elements have been considered as forming a family analogous to that of the 14 lanthanide elements, and the physicochemical properties of the two series have often been deemed to be comparable. However, as regards chemical behavior, while the lanthanide family stands as a relatively homogeneous group, such is not the case for actinides. Indeed, the first elements in the series, up to americium, exhibit properties that are very close to those of uranium, and altogether different from those found in lanthanides. On the other hand, the second group of elements in the series, from curium on, do exhibit properties close to those of lanthanides.

At the same time, as indeed occurs with the lanthanide (Ln) family, rising atomic numbers, for actinide elements, along the periodic table, are accompanied by a decrease in ionic radii (the actinide contraction). Thus, the prediction may be made that, when an ionic interaction is being approximated, i.e. by way of a formalization in terms of ionic potential – this corresponding to the ratio of ion charge, over ion radius (or to ion hardness, to take up the scheme propounded by R. G. Pearson\*) – an ion of an element of higher atomic number will exhibit greater reactivity than an element of lower atomic number. While such a tendency is indeed valid for ions in oxidation states +III or +IV, with ligands\* involving no particular steric constraint, this ceases to be verified for ions at oxidation states +V, +VI.

One remarkable property of actinides in the early part of the series, compared with the lanthanide series, is their ability to form oxocation entities, of linear structure, for elements in oxidation states +V, or +VI. These are then known as actinyl ions, the -yl suffix indicating the presence of a *trans*-dioxo form:  $AnO_2^{n+}$  (see Fig. 4).

In the actinide series, only elements uranium, neptunium, plutonium, and americium have this ability to form actinyl cations. Protactinium is only able, it would seem, to form one monooxo species, and this in certain conditions only.

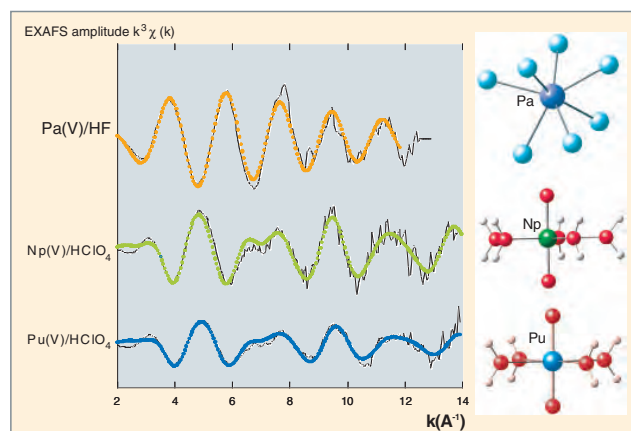

Fig. 4. Experimental (lines) and simulated (dots) EXAFS\* spectra at the LIII level for protactinium, neptunium, and plutonium, in acidic aqueous solution. The data obtained from EXAFS measurements are compared with the models arrived at through quantum chemistry computations, shown to the right of each spectrum (samples prepared in ATALANTE [Np, Pu] and at Orsay [Pa]; measurements recorded at ESRF and Stanford; computations carried out at CEA).

The covalent nature of the *trans*-dioxo bond causes strong axial anisotropy, inducing a so-called “equatorial-plane” coordination chemistry, whereby ligands may complete the oxocation’s coordination sphere. Such configurations are known as coordination polyhedra of the bipyramid type, involving coordination numbers of the type 5 + 2, or 6 + 2 (“2” representing the two -yl oxygen atoms). At the same time, owing to the covalent nature of the *trans*-dioxo bond, it is agreed that the effective charge, as localized at the metal center, stands at about 3.3 for uranyl ion  $UO_2^{2+}$ , and 2.2 for the  $NpO_2^+$  neptunyl ion. While this notion has yet to be corroborated, it does appear that many experimental findings, in particular the formation of cation–cation complexes with actinyl ions in oxidation state +V, do show that the charge localized at the metal center is probably higher than the overall charge carried by the molecular entity of charge + 1 or + 2, far lower though than the formal charge, relating to the actinide’s oxidation number.

As a final point, it should be noted that actinide ions, at oxidation states +III and +IV, and indeed +V and +VI, are highly hydrated, and that the layer of water molecules surrounding the cation may be seen as a hydration sphere. As an initial approach, the assumption is made that the hydration sphere, for actinide ions in oxidation states +III, +IV, comprises 8 or 9

water molecules, whereas, in the case of actinide ions in oxidation states +V, +VI, the hydration sphere comes down to 4 or 5 water molecules, mainly localized in the equatorial plane (see Fig. 6).

A further assumption is made, that a second hydration sphere surrounds the hydrated actinide cations, with water molecules that appear to interact with those in the first sphere by way of hydrogen bonds. On the other hand, structural data, as regards how this second sphere is organized, remain altogether scant. Obviously, it should not be forgotten that these water molecules, whether in the first or the second sphere, enter into exchanges, at varying rates – depending on oxida-

tion state – with water molecules that are not directly bound to the cation.

Finally, it should be noted that, while hydration of such ions is of crucial importance, for our understanding of the chemistry of actinides in aqueous solution, as indeed of the coordination chemistry of these ions, this phenomenon is likewise of great importance for our understanding of extraction mechanisms for such ions, from the aqueous phase to an immiscible organic phase. Indeed, in most cases, cations extracted into an organic phase are dehydrated, i.e. their hydration sphere is replaced by a coordination sphere, made up of the donor atoms in the extractant molecules.

### Similarities and differences between actinides and lanthanides

With a general electron configuration of the form  $[Rn]5f^m6d^n7s^2$ , actinide elements occur in the periodic table once the 4f and 5d orbitals are fully occupied. From the time of their discovery, these elements have been seen as forming a family, analogous to that of the 14 lanthanides (exhibiting an electron configuration of the form  $[Xe]4f^n5d^m6s^2$ ), and their physicochemical properties have often been deemed comparable. Indeed, each of these two series comprises elements corresponding to the filling of one nf subshell. These orbitals (4f and 5f, respectively) are of limited radial extension, and are thus shielded from interactions with ligands by the saturated shells, i.e.  $5s^2-5p^6$ , and  $6s^2-6p^6$  respectively. Consequently, such nf electrons interact but weakly with electrons from adjacent ligands, and their electronic properties are little affected by their environment. However, a difference may be found between the two series: 4f orbitals are far more localized than 5f orbitals, and may thus be treated as core orbitals. This low spatial extension of 4f electrons fully explains why lanthanides chiefly exhibit an oxidation state of +III. By contrast, 5f electrons, being less localized, play a slightly larger part in chemical bonding, while interactions between 5f electrons and ligands are more extensive than is the case with lanthanides. Such relative delocalization is more significant for elements in the first half of the actinide series, from Pa to Am. Indeed, for these elements, the energies of the 5f, 6d, 7s, and 7p orbitals are sufficiently close for them to undergo hybridization, allowing a spatial overlap between these orbitals and valence orbitals in the ligands. As a result, it is often difficult to decide whether bonds of this type are of covalent, or ionic character. Thus, elements from the first half of the series are far more markedly akin to transition metals than to lanthanides.

Within the family, rising atomic numbers Z induce an increased Coulomb attraction, stabilizing 5f orbitals. This is the reason for the fairly regular decrease in size of actinide ions, as one progresses along the series, with rising Z (actinide contraction). Increasingly localized, the 5f electrons undergo less interaction with the environment, and the chemical behavior of elements beyond americium comes closer to that of the lanthanides. Onto

this Coulomb effect are superimposed relativistic effects (both direct, and indirect), which further modify the radial distribution of electron orbitals (see Fig. 5).

To sum up, it should be emphasized that the multiplicity of oxidation states exhibited by actinides reflects this ensemble of electronic properties. Thus, the comparison often made, on the one hand with transition metal chemistry, and, on the other, with lanthanide chemistry, while an oversimplification, is nonetheless not wholly unfounded.

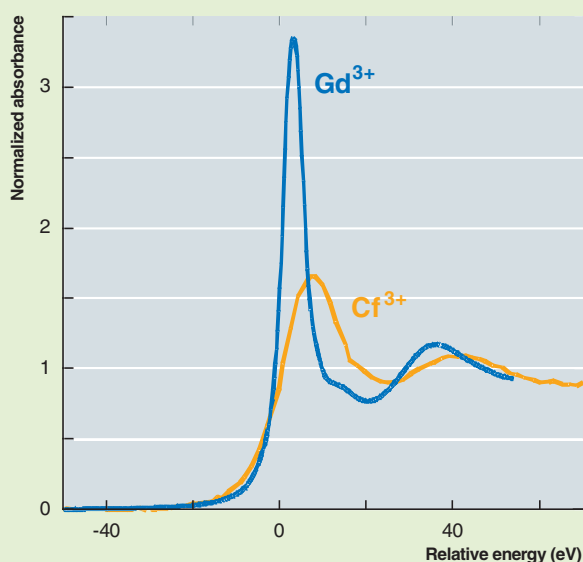

Fig. 5. XANES\* spectra, at level  $L_{III}$ , for gadolinium and californium, in acidic aqueous solution. The difference in width of the absorption lines (broader for Cf than for Gd) evidences in part the distinct behaviors exhibited by valence orbitals in the metal cation, in either of these families.



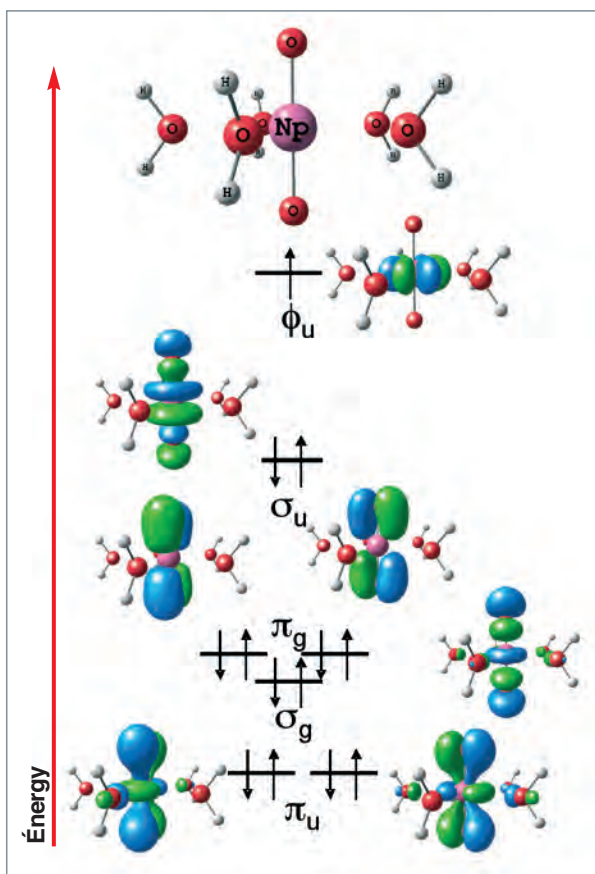

Fig. 6. Diagrams, and schematics, of neptunyl ion molecular valence orbitals in the aqueous compound  $[\text{NpO}_2(\text{H}_2\text{O})_5]^{2+}$ . The molecular orbitals labeled  $\sigma_g$  and  $\pi_g$  correspond to a linear combination of 6d atomic orbitals from Np atoms, and 2s–2p orbitals from oxygen atoms. Orbitals labeled  $\sigma_u$  and  $\pi_u$  correspond to a linear combination of 5f–6p orbitals from Np atoms, and 2p orbitals from oxygen. *Ab-initio* computations, using density-functional theory, and the ZORA code, carried out at Marcoule.

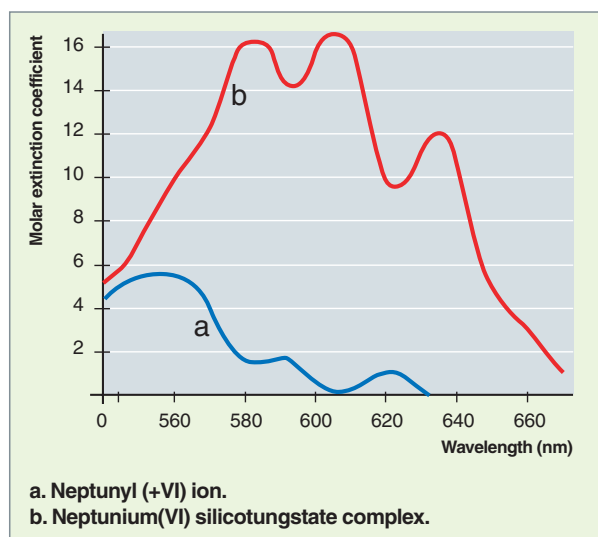

Fig. 7. Absorption spectra for neptunium(+VI) solutions. The presence of sharp peaks in the visible region is what gives aqueous actinide solutions their colors.

By way of conclusion, as regards these general remarks on actinide aqua species, it is of interest to note that actinide ion solutions are colored (see Fig. 7). Each oxidation state exhibits a specific electronic absorption spectrum, thus providing a unique signature. Recording the electronic absorption spectrum, in particular that corresponding to f–f transitions, thus allows, for a given concentration range, actinide ion speciation to be determined, i.e. the oxidation state involved, and the formation of complexes in solution. In this respect, actinides in the early part of the series exhibit a property of special interest: some of their ions show highly selective photon absorption, in terms of photon energies, in the visible or near infrared region. Such is the case, in particular, for  $\text{NpO}_2^{2+}$  and  $\text{Np}^{4+}$ ,  $\text{PuO}_2^{2+}$ , or  $\text{Am}^{3+}$  and  $\text{AmO}_2^{2+}$ . The narrowness of these absorption peaks (a few nanometers at half height), together with the high molar extinction coefficients found, compared with those exhibited by other actinide ions, make these spectra particularly useful, for the purposes of probing ions in solutions, in particular to monitor changes in symmetry around the metal cation.

At the same time, as is the case for the lanthanide family, recording these “hypersensitive” transitions allows changes of symmetry in the complex to be very precisely evaluated.

Mention should be made of the tools classically used to characterize such ions in solution, such as nuclear magnetic resonance (see Fig. 8), X-ray absorption spectroscopy, fluorescence spectroscopy (for  $\text{UO}_2^{2+}$ ,  $\text{Am}^{3+}$ ,  $\text{Cm}^{3+}$  ions), or vibrational spectroscopy techniques, such as infrared or Raman spectroscopies (see Fig. 9).

Further, the development of theoretical computation techniques has made it possible to put forward a complementary insight as to the chemical behavior of these elements.

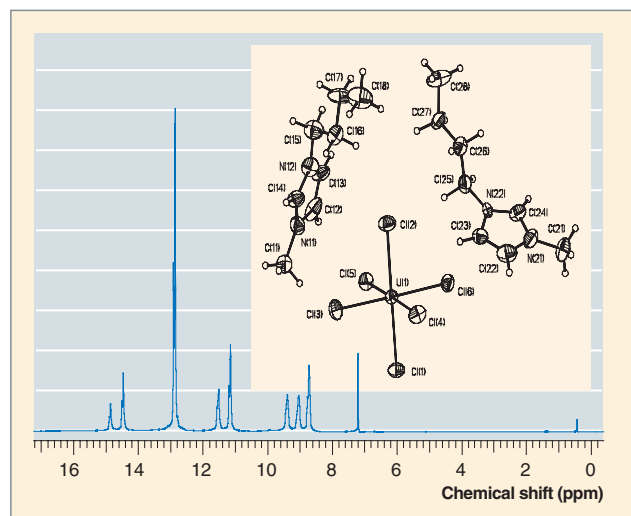

Fig. 8. NMR spectrum, from protons in the complex  $[\text{BuMelm}]_2[\text{UCl}_6]$ , in a deuterated solvent ( $\text{CD}_2\text{Cl}_2$ ); and structure of this complex in the solid state, as derived from the single crystal X-ray diffraction spectrum.

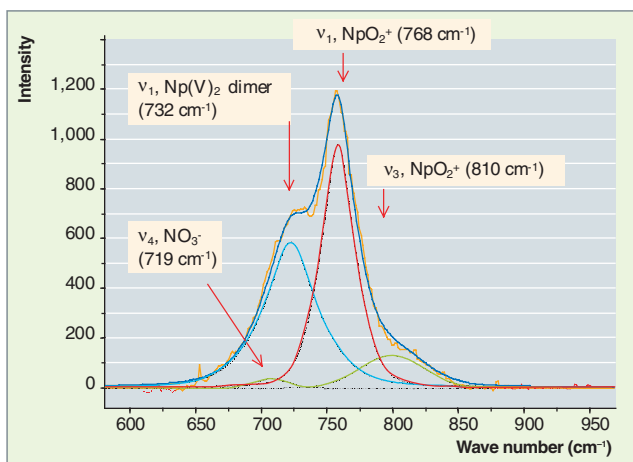

Fig. 9. Raman spectroscopy of a concentrated neptunium aqueous solution (3.71 mol/l), as obtained in ATALANTE, showing the presence of the dimer complex Np(V)–Np(V). Dotted curves plot components in the spectrum, resolved into the characteristic vibration bands for the monomer and the dimer, which are both present in the solution.

More recently, soft ionization techniques, coupled with mass spectrometry (e.g. electrospray ionization: ESI–MS), have been used for the speciation of ions in solution. Finally, to round off this inventory, it should be said that the usefulness of such techniques is further enhanced when they are coupled, as e.g. EXAFS or XANES measurements coupled with an electrolysis cell; or coupling capillary electrophoresis with a high-resolution mass spectrometer.

**Philippe MOISY and Christophe DEN AUWER,**  
*Radiochemistry and Processes Department*

With contributions from *Éric SIMONI,*  
*IPN Orsay*

## Some oxidation-reduction properties of actinides

The first microgram of plutonium was isolated in the laboratories of the University of Chicago (the initial site for the Manhattan Project), by means of several cycles involving oxidation with Ag(II) ions, and reduction by HNO<sub>2</sub>, combined with coprecipitation with lanthanum fluoride. As early as 1944, considerable amounts of plutonium, in the form of a highly insoluble plutonium phosphate compound, were being yielded by redox cycles, using bismuthate ions (BiO<sub>3</sub><sup>-</sup>) as oxidizing agent, and nitrous acid as reducing agent, in the presence of bismuth phosphate (BiPO<sub>4</sub>). The first plutonium purification process involving liquid-liquid extraction was implemented by way of oxidation of plutonium to Pu(VI) by dichromate ions (Cr<sub>2</sub>O<sub>7</sub><sup>2-</sup>), with subsequent **extraction**\* of plutonium to an organic phase by methyl isobutyl ketone (MIBK), and finally **back-extraction**\* (stripping) to the aqueous phase, after reduction to Pu(III) by Fe(II). In like manner, plutonium purification operations carried out in the USSR (at the Radium Institute of the Academy of Sciences [RIAN]), as early as 1945, were based on a redox cycle, cycling plutonium between oxidation states +VI, +IV, and +III, combined either with precipitation of acetate salts, or of oxalate salts. Such reminders of the initial methods used for plutonium isolation, and purification clearly highlight the major importance of the oxidation-reduction (redox) properties exhibited by plutonium, for partitioning purposes, whether from other actinides, or fission products.

### Major actinides (U, Pu)

Plutonium may occur in 5 distinct oxidation states in aqueous solution. In its four main oxidation states (from +III to +VI), it is surrounded by a hydration sphere, in noncomplexing acidic media, where it takes the following ionic forms: Pu<sup>3+</sup>, Pu<sup>4+</sup>, PuO<sub>2</sub><sup>+</sup>, PuO<sub>2</sub><sup>2+</sup>. The chemical forms this element – it is nowadays agreed – may take for oxidation state +VII are PuO<sub>3</sub><sup>+</sup>, in an acidic medium, and PuO<sub>4</sub>(OH)<sub>2</sub><sup>3-</sup> in a strongly basic medium.

Figure 10 shows the Latimer diagram for plutonium in non-complexing acidic solution, displaying the redox potentials corresponding to the redox transitions of the various plutonium ions. It should be noted that the high instability exhibited by oxidation state +VII, for plutonium in an acidic medium, precludes a redox potential being determined with any great precision in such media. Nevertheless, a value for the potential of the Pu(VII)/Pu(VI) couple, at about 2.44 V/SHE, has already been suggested, in a noncomplexing acidic medium (1 M HClO<sub>4</sub>).

Values for the potentials of the other redox couples lie quite close to one another, around 1.0 V/SHE. Such closely clus-

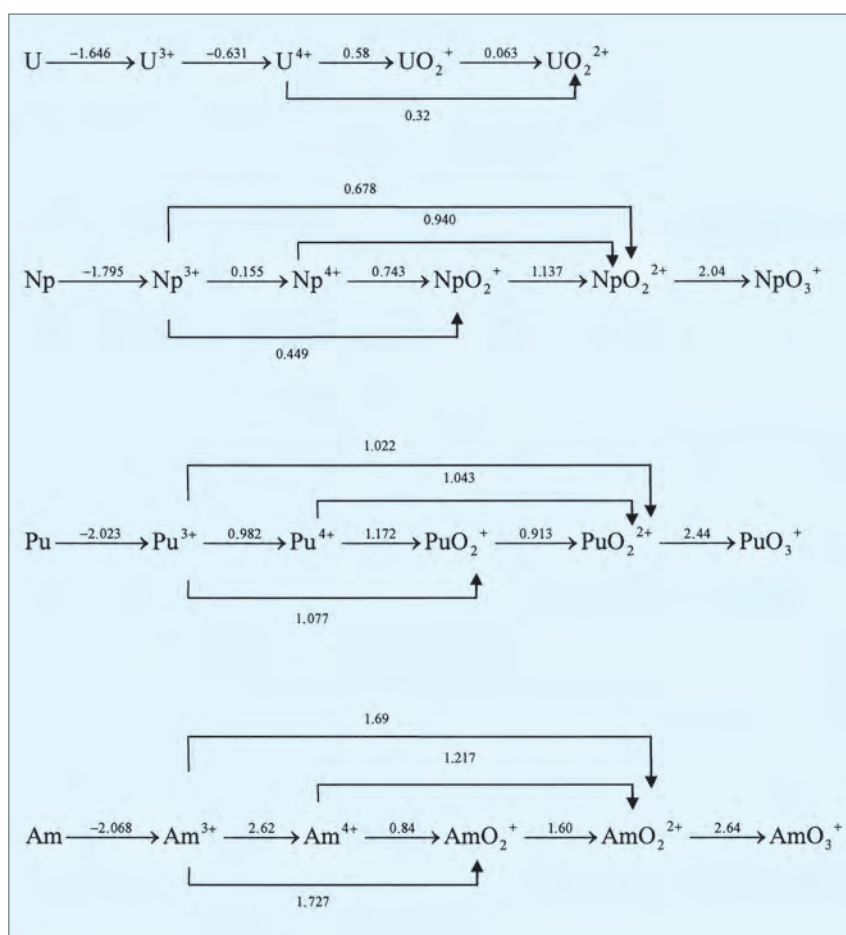

Fig. 10. Latimer diagram, showing standard potentials for uranium, neptunium, plutonium, and americium couples, in a 1 M perchloric acid medium (in V/SHE).

tered values, for the potentials of the three redox couples Pu(VI)/Pu(V), Pu(V)/Pu(IV), and Pu(IV)/Pu(III), account for this element having the exceptional property of occurring in acidic solution with four distinct oxidation states, simultaneously. This property, unique as it is in acidic media, results in a highly complex redox behavior for this element.

Further, from this close clustering of values for plutonium potentials, together with the ion speciation found for the various oxidation states, Pu<sup>3+</sup>, Pu<sup>4+</sup>, PuO<sub>2</sub><sup>+</sup>, PuO<sub>2</sub><sup>2+</sup> – and thus from the involvement of protons for redox couples Pu(V)/Pu(IV) and Pu(VI)/Pu(IV) – it may be inferred that plutonium at oxidation states +IV, +V is unstable, being liable to undergo **disproportionation\***, depending on ambient medium acidity. It is indeed, in part, owing to this Pu(IV) disproportionation constraint that operations are carried out in an acidic medium, with a proton concentration higher than 1 mole per liter, for nuclear fuel treatment.

Finally, it should be mentioned that the quantitative reduction of this element to the metallic form may not be carried out, in aqueous solution, with an electrode made of noble metal, owing to the strongly negative value of the redox potential, relative to the reduction potential of water. Thus, plutonium in the metal form is highly oxygen-“hungry;” this making the metal **pyrophoric\***, and entailing handling complications. Thus, even though many oxides do exist, the chief characteristic of the Pu–O system is the existence of one particularly stable phase, of formula PuO<sub>2</sub>. This phase, which crystallizes according to the face-centered cubic system, is stable at atmospheric pressure, from ambient temperature to temperatures far higher than 2,000 °C. As this physicochemical form exhibits high stability, PuO<sub>2</sub> oxide is the plutonium end product, for the nuclear industry. Further, this oxide is isomorphic with uranium oxide UO<sub>2</sub>, with which it forms solid solutions of formula (U, Pu)O<sub>2</sub>, a compound that may be used for the fabrication of nuclear fuels. As is the case for plutonium, elements protactinium, neptunium, americium, curium, or californium are stable, and isomorphic in the MO<sub>2</sub> dioxide form, notwithstanding the instability exhibited by these elements at oxidation state +IV, in aqueous solution.

To complement this analysis of the Latimer thermodynamic diagram, it is crucial to take into account the kinetics of such redox processes. Indeed, the breaking, or setting up of trans-dioxo bonds exhibits a slow kinetics, compared with charge transfer kinetics. Thus, in highly simplified fashion, redox couples may be classified into two families: so-called “fast” redox couples, and so-called “slow” redox couples. The former include couples Pu(IV)/Pu(III) and Pu(VI)/Pu(V), for which only a charge transfer occurs. The second group covers couples Pu(IV)/Pu(V) and Pu(IV)/Pu(VI), involving a slow-kinetics chemical reaction (the setting up, or breaking of trans-dioxo bonds) coupled with the charge transfer. While this notion of redox kinetics does remain a qualitative one, it is crucial that it be taken on board, since it is such kinetic control of reac-

tions that allows the various redox reactions encountered with plutonium, and actinides in general, to take place, or otherwise.

Investigation of redox behavior in a nitric acid medium has been widely carried out, owing to the use of this mineral acid in nuclear fuel treatment operations. However, the data available is still much discussed in the literature. As regards the nitric acid medium, it is agreed that redox potential values for couples Pu(VI)/Pu(IV) and Pu(VI)/Pu(V) are very little altered, while the potential of couple Pu(IV)/Pu(III) is lower than that found in a noncomplexing acidic medium. As predicted by the Nernst equation, the potential value for that couple falls with rising nitric acid concentration, evidencing the complexing effect of nitrate ions with plutonium at oxidation state +IV. Thus, the shift observed in redox potentials, as a function of nitrate ion concentration, results in raising the stability of plutonium in oxidation state +IV, thus limiting its capacity for disproportionation.

Finally, it should be noted that the instability of nitric acid, both with respect to temperature, and ionizing radiation, results in a buildup, in the solution, of a number of species, of varying solubility in aqueous solution: NO<sub>2</sub> (more accurately, N<sub>2</sub>O<sub>4</sub>), HNO<sub>2</sub>, and NO. The mixture of these gases (NO, NO<sub>2</sub>...) is noted as NO<sub>x</sub>. With these species present, the redox potential of the aqueous acid solution has been estimated to stand at about 1.0 V/SHE, i.e. a value that lies very close to the redox potentials of plutonium. Thus, controlling such species in the nitric acid medium allows the oxidation state of plutonium to be controlled in the solution.

As regards uranium, the oxidation states that are stable, or metastable in a noncomplexing acidic medium are oxidation states +IV (U<sup>4+</sup>), +V (UO<sub>2</sub><sup>+</sup>), and +VI (UO<sub>2</sub><sup>2+</sup>). As with plutonium, the instability of oxidation state +V, in uranium, as a function of acidity, results in a buildup of U(IV) and U(VI), due to U(V) **disproportionation\***. It should be noted that the redox potential of the couple U(VI)/U(IV) is markedly lower than that of couple Pu(IV)/Pu(III), and that, consequently, uranium in oxidation state +IV has the ability to reduce plutonium to oxidation state +III. This is indeed the chief reaction allowing the partitioning of plutonium from uranium, in the reductive back-extraction step in the PUREX process.

Finally, it should be noted that the potential of couple U(VI)/U(IV) is likewise markedly lower than that determined, in a nitric acid medium, by the presence of nitrous acid (HNO<sub>2</sub>) and nitrogen oxides (NO<sub>x</sub>), these being stabilized, in aqueous solution, owing to HNO<sub>2</sub> disproportionation. In such conditions, uranium in oxidation state +IV is unstable in a nitric acid medium, if due precautions are not taken to ensure no nitrous acid is present. The compound used, as a rule, in nitric acid media, to preclude the presence of nitrous acid, is hydrazinium nitrate (N<sub>2</sub>H<sub>5</sub><sup>+</sup>), this having the specific property of reacting, with extremely fast kinetics, with nitrous acid. When used in

the PUREX process (see the section on “The PUREX process”, pp. 33–86), this reactant is often presented as an antinitrous agent. However, the kinetic constraint of *trans*-dioxo bond formation, or break, accompanying charge transfer for the couple U(VI)/U(IV), results in partial stabilization of uranium in oxidation state +IV, in a nitric acid medium, conferring on it a degree of metastability. On the other hand, such instability of uranium in oxidation state +IV is particularly useful, since it favors the dissolution of uranium oxide (UO<sub>2</sub>) nuclear fuel in a nitric acid medium. Indeed, the oxidizing dissolution of U(IV) (in UO<sub>2</sub> form) to U(VI) (UO<sub>2</sub><sup>2+</sup>) is catalyzed by the presence of nitrous acid, in a nitric acid medium.

### Minor actinides (Np, Am, Cm)

As regards neptunium, analysis of the Latimer diagram shows that, contrary to what is the case for plutonium, and uranium, oxidation state +V is the most stable state, in an acidic medium. On the other hand, as with uranium, oxidation state +III is metastable. Such metastability is due, essentially, to oxidation by traces of oxygen, owing to the low value of the redox potential for the couple Np(IV)/Np(III), and the stabilization of Np(IV), in aqueous solution, by the presence of a **ligand\***. In a nitric acid medium, neptunium in oxidation states +V, and +VI exhibits a complex redox behavior, since the redox potential of this couple is very close to that of nitrogen oxides (NO, NO<sub>2</sub>), and nitrous acid. Indeed, in the absence of an antinitrous agent, these species are liable to act as Np(V) oxidizing agents, but equally as Np(VI) reducing agents. Such reactions are often characterized in terms of an “autocatalytic mechanism,” i.e. a mechanism whereby the reduced form of one redox couple also stands as the oxidized form of another redox couple, of higher redox potential.

Americium is a special case, inasmuch as the redox potential of couple Am(IV)/Am(III) is very high (about 2.34 V/SHE), making the element highly unstable in oxidation state +IV. This instability results, through disproportionation, in formation of Am(III) and Am(V). Americium in oxidation state +V is likewise unstable, undergoing disproportionation to yield Am(VI) and Am(IV). Specifically regarding americium, it should be noted that self-absorption of alpha radiation, subsequent to radioactive decay processes, results in reduction of its higher oxidation states (+VI, +V). As is the case for plutonium in an acidic medium, americium in a complexing basic medium exhibits a highly complex behavior. By way of example, this element may occur in all four of its oxidation states in a concentrated carbonate medium.

With respect to curium, the redox behavior this exhibits in aqueous solution is altogether straightforward, inasmuch as only two oxidation states may occur (+III, +IV). This difference in redox behavior, compared to that of americium (which may occur in oxidation states +V, +VI) has been targeted by much research work, for the purpose of developing a separation

#### A methodology for the investigation of the redox behavior of actinide ions with nitrous acid, in a concentrated nitric acid medium: the case of the couple Np(VI)/Np(V)

The complex redox behavior exhibited by actinide ions, and the couple nitric acid–nitrous acid makes any predictive modeling of redox phenomena a highly problematical venture. In this context, a methodology has been developed, and applied to the couple Np(VI)/Np(V). Bearing in mind the extraction of Np(VI) by TBP, one option for neptunium separation is to channel all of that element with the uranium and plutonium stream, through oxidation of Np(V) to Np(VI). Such selective oxidation of neptunium must be carried out without, in so doing, affecting the other elements present, and, more specifically, without disturbing plutonium, which must be kept in oxidation state +IV. To achieve this, the selective oxidation of Np must be effected through minor modifications of current operational conditions, this calling for a high degree of control as regards the equilibrium between Np(V) and Np(VI), in a nitric acid medium, in the presence of nitrous acid (reaction 1):



Taking into account the constituents, rather than the chemical species, equilibrium (1) may be restated as follows:

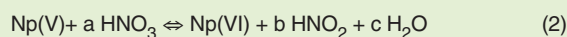

In this equilibrium, neptunium occurs in the form of nitrate complexes, and a, b, c are the apparent stoichiometric coefficients.

The methodology developed, for the purposes of dealing in quantitative terms with this equilibrium, works on the basis of taking into account the thermodynamic activity of the major constituents in the system (water, nitric acid, nitrous acid). Using this methodology thus made it possible to determine the apparent stoichiometric coefficients, and, as a result, the relevant thermodynamic quantities, in a complex reaction medium.

In like manner, processing the kinetics data by way of a degeneration of partial orders, with respect to the thermodynamic activities of HNO<sub>3</sub>, HNO<sub>2</sub>, and water activity made it possible to determine the kinetic law. Taking into account the influence of temperature allowed the activation energy to be determined, for the Np(V) oxidation reaction, as for the Np(VI) reduction reaction.

method for these elements. Perusal of the Latimer diagram clearly shows the low stability of Cm(IV), owing to the high value of the redox potential.

## “Heavy” actinides

As regards californium and berkelium, the most stable oxidation state, in aqueous solution, is the +III state, even though oxidation state +IV is known to occur, particularly in the  $\text{CfO}_2$  form. For the heavier elements, from einsteinium to mendelevium, oxidation state +III is the most stable, even though these elements may occur in oxidation state +II. As regards nobelium, the order of stability is reversed, this element being most stable in oxidation state +II. The case of lawrencium (the last element in the actinide family, discovered in 1961), as with actinium, is quite straightforward, since the only oxidation state accessible in aqueous solution is the +III state.

**Philippe Moisy,**

*Radiochemistry and Processes Department*

## Some complexation properties of actinides cations

The ability of actinide cations to enter into complexes varies widely, depending on oxidation state. Owing to the mainly ionic nature of the bond between actinide cations and ligands, it is actinide ions in oxidation state +IV that will undergo **complexation**\* most strongly, in aqueous solution. In terms of the acidity scale drawn up by R. G. Pearson\*, actinide ions are ranged among the harder acids, thus preferentially reacting with harder bases. In qualitative terms, it is agreed that the strength exhibited by complexes depends on the metal cation's ionic potential, i.e. the ratio of ion charge, over ion radius. Two further parameters must be considered, in the particular case of actinyl ions, namely, on the one hand, the effective charge at the metal cation, and, on the other hand, the restriction of cation accessibility to the equatorial plane. This induces what is known as an "equatorial-plane coordination chemistry." Finally, it should be noted that steric constraints relating to the ligand may also influence this qualitative ranking. Indeed, a comparison may not readily be made between anions involving virtually no steric constraint, in aqueous solution, such as anions  $O_2^{2-}$  (this being the basic, complexing form of dihydrogen peroxide  $H_2O_2$ ) and  $OH^-$ ; a moderate constraint, as in the case of oxalate anions; or a strong constraint, as is the case for polyaminocarboxylic acids, such as diethylenetriaminepentaacetic acid (DTPA), or ethylenediaminetetraacetic acid (EDTA).

Coordination numbers, for actinide ions in oxidations states +III, and +IV, are as a rule higher than 7, and may go as high as 12 for the larger cations, such as thorium(IV). Coordination chemistry for oxidation states +III and +IV involves coordination polyhedra, appearing for coordination numbers around 9, often akin to capped prisms, antiprisms, or trigonal dodecahedra. Coordination numbers for actinyl ions (oxidation states +V, +VI) often stand at 5 + 2, or 6 + 2, i.e. they involve the shape of a penta- or hexagonal bipyramid. It should be noted that it is indeed according to this geometry that uranyl nitrate ( $[UO_2(NO_3)_2(H_2O)_2] \cdot 4H_2O$ ) crystallizes, this being a compound frequently found in nuclear fuel treatment operations. By way of illustration of these complexation phenomena, a number of examples are outlined here, taken from instances most commonly met with in the chemical conditions prevailing in nuclear fuel treatment, or in those conditions that are best avoided, such as actinide ion hydrolysis.

### The hydrolysis case

Among those complexes that must be taken into account in nuclear fuel treatment operations, hydroxo complexes (yielded by hydrolysis reactions) take a special place. Indeed, such complexes may give rise to a colloidal macromolecular network, this being virtually inert with respect to any chemical reaction, and moreover liable to form deposits. Owing to these constraints, chemical operations involving plutonium are to be carried out using solutions of sufficiently high acidity to preclude plutonium hydrolysis.

It is agreed that actinide susceptibility to hydrolysis varies with ionic potential, i.e. that interaction intensity increases, on the one hand, with the charge localized at the metal center, for a given element – + 4 ( $An^{4+}$ ), + 3.3 ( $AnO_2^{2+}$ ), + 3 ( $An^{3+}$ ), + 2.3 ( $AnO_2^+$ ) – and, on the other hand, with rising atomic numbers, for ions in oxidation states +III, or +IV. It should be noted that the hydrolysis mechanism involves, as an initial step, transfer of a proton belonging to a coordinated water molecule from the first sphere, to a water molecule located in the second coordination sphere. In a subsequent step, this proton is expelled from the second coordination sphere, to the reaction medium. Finally, it has been found that hydrolysis of the cations least susceptible to hydrolysis ( $An^{3+}$ ,  $AnO_2^+$ ) results in formation of monomer species, whereas hydrolysis of the more acid cations ( $An^{4+}$ ,  $AnO_2^{2+}$ ) gives rise to polymerization phenomena. By way of illustration of some of these points, we may opt to consider more specifically the behavior of plutonium with respect to hydrolysis reactions.

Very little is available, by way of data concerning Pu(III) and Pu(V) hydrolysis. The main reason for this is the instability of Pu(III) relative to its oxidation to Pu(IV), as of Pu(V) with respect to disproportionation, to yield Pu(IV) and Pu(VI). In order to get around these constraints, data on the hydrolysis of actinides in oxidation state +III were mainly obtained with americium, which is stable in oxidation state +III, with respect to redox processes. For oxidation state +V, only neptunium was used, this being the only element for which there is stability in this oxidation state. It is agreed that the onset of actinide hydrolysis, in oxidation states +III, +V (formation of a complex of 1:1 stoichiometry) is found to occur for pH values of 7, and 9, respectively.

## An example of actinide (IV) complexation, as applied to decorporation

Decorporation has the purpose of ridding the organism, by means of a complexing chemical substance, of toxic chemical and/or radioactive elements, incorporated into the biological medium. Currently, DTPA is seen as the treatment to be used in the event of contamination. However, *in vivo* studies show that its effectiveness may yet be improved. The chemical behavior of An(IV) in the presence of DTPA has been targeted by a limited number of studies, which do not always yield consistent findings, from one study to the next. Moreover, the structure of such complexes is, as yet, not fully resolved, and the issue of the coordination number for the cation in the complex is still being debated.

A structural investigation was thus carried out, using nitrilotriacetic acid (NTA) as ligand, i.e. with a molecule that may be seen as a model for DTPA. The thermodynamic investigation allowed all of the complexation constants to be determined, for actinides in oxidation state +IV, while the structural investigation made it possible to provide a description of the coordination sphere, for all limiting complexes.

Spectrophotometric monitoring of actinide solutions, as a function of the amounts of NTA added, allowed, by means of spectral deconvolution, actinide speciation to be determined in solutions (see Fig. 11).

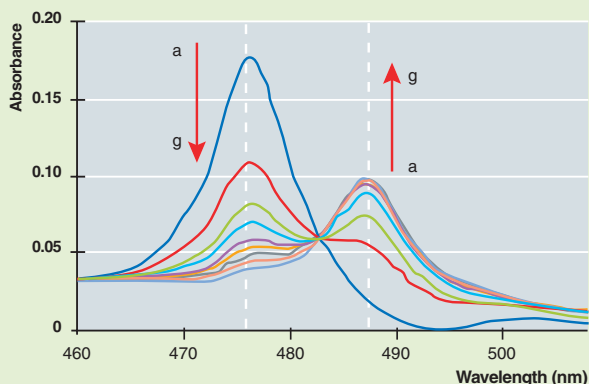
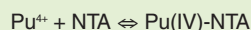

Fig. 11. Spectrophotometric monitoring of the Pu(IV)-NTA complex, of 1:1 stoichiometry; [Pu(IV)] = 3 mM, [H<sup>+</sup>] = 1 M.  
 a) [NTA]<sub>tot</sub> = 0.001 M; b) [NTA]<sub>tot</sub> = 0.004 M; c) [NTA]<sub>tot</sub> = 0.006 M;  
 d) [NTA]<sub>tot</sub> = 0.01 M; e) [NTA]<sub>tot</sub> = 0.004 M; f) [NTA]<sub>tot</sub> = 0.008 M;  
 g) [NTA]<sub>tot</sub> = 0.01 M.

Thus, from these experimental data, the conditional, and apparent formation constants may be calculated, for the various complexes:



$$K_{4,1}^{\text{cond,Pu}} = \frac{[\text{Pu(IV)-NTA}]}{[\text{Pu}^{4+}] [\text{NTA}]_{\text{tot}}^{\text{free}}}$$

Through application of an absorption spectrum deconvolution methodology, for lower acidity values, and added amounts of NTA up to 0.001 M, Pu(IV)-NTA and Pu(IV)-NTA<sub>2</sub> concentrations were determined, in each sample, along with the formation constants for the complex of 1:2 stoichiometry:



$$K_{4,2}^{\text{cond,Pu}} = \frac{[\text{Pu(IV)-NTA}_2]}{[\text{Pu(IV)-NTA}] [\text{NTA}]_{\text{tot}}}$$

A similar study was carried out with neptunium in oxidation state +IV, and uranium, likewise in oxidation state +IV. Finally, as regards thorium, a method was used involving competition with neptunium, resulting in calculation of the complexation constant for Th(IV), for complexes of 1:1 stoichiometry. Finally, extrapolation of the findings obtained for U(IV), Np(IV), and Pu(IV) allowed the second complexation constant to be determined, for Th(IV).

Values for the apparent constants, for complexes yielded in aqueous solutions, are shown in Table 1.

Table 1.

Apparent formation constants for An(IV) complexes formed with NTA.		
	log K <sub>4,0,1</sub> <sup>app</sup>	log K <sub>4,0,2</sub> <sup>app</sup>
Th(IV)	14.6 ± 0.3	11.7 ± 0.8
U(IV)	15.6 ± 0.8	13 ± 0.8
Np(IV)	16.4 ± 0.2	14.2 ± 0.5
Pu(IV)	17.4 ± 0.2	15.2 ± 0.5

Theoretical chemistry calculations were carried out, on the basis of density functional theory, examining a number of different assumptions (see Fig. 12):

- a coordination number of 8 for the cation, exhibiting C<sub>2</sub> or S<sub>6</sub> symmetry (noted as A, and B respectively);
- a coordination number of 9 for the cation, obtained by adding one water molecule to the inner coordination sphere, exhibiting C<sub>2</sub> symmetry (noted C).



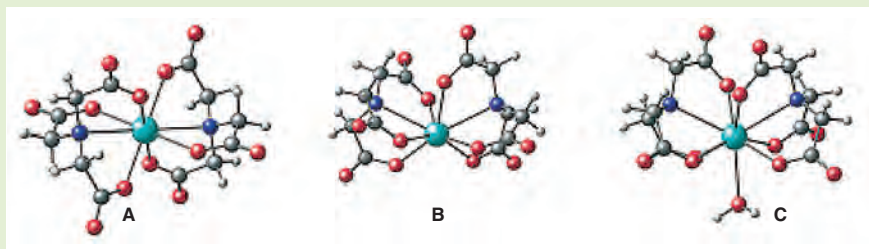

Fig. 12. The structures considered for the limiting complexes  $[\text{An}(\text{IV})\text{-NTA}_2]$ .

For the purposes of comparing these various structures, structure A was selected as reference structure. The findings show that, when the cation involves eightfold coordination, the most stable structure, in energy terms, is that exhibiting  $C_2$  symmetry (structure A), regardless of the cation. The energy difference between structures of  $C_2$  symmetry involving a coordination number of 8, or 9 means that cations exhibiting eightfold coordination (structure A) are more stable, in solution, for Np(IV) and Pu(IV), whereas the cation exhibiting ninefold coordination (structure C) is more stable in the case of Th(IV). As regards U(IV), the energy difference between the two coordination numbers is low, warranting no definite conclusion.

EXAFS spectra were measured, for solutions containing only the limiting complex,  $[\text{An}(\text{IV})\text{-NTA}_2]$ , for the four actinides Th, U, Np, Pu. Spectra were acquired at the LIII level of the actinide, on the Rossendorf Beamline at ESRF, the European Synchrotron Radiation Facility.

Average values for M–O distances thus determined show a decrease in size for the first coordination sphere, from Th(IV) to Pu(IV), consistent with the evolution commonly found in coordination chemistry, whereby complexes become thermodynamically more stable as element atomic number rises.

More detailed analysis of EXAFS spectra, involving several coordination spheres, allows the metal–nitrogen distances to be determined. It is apparent that the part played by the nitrogen atom in the first coordination sphere becomes increasingly important, as element atomic number rises, along the actinide series.

The findings from theoretical chemistry computations, as from EXAFS measurements would seem to indicate that Np(IV) and Pu(IV) exhibit a coordination number of 8, whereas Th(IV) exhibits a coordination number of 9, in the  $[\text{An}(\text{IV})\text{-NTA}_2]$  complex. The case of the  $[\text{U}(\text{IV})\text{-NTA}_2]$  complex in solution calls for more careful interpretation, however the structure of the solid, crystallized compound – which has been determined – implies a coordination number of 9 for this cation. The coordination number, for actinides in oxidation state +IV, thus varies along the series: 8 for Np(IV) and Pu(IV); 9 for Th(IV), U(IV).

This finding may be correlated with the previously obtained stability constants for complexes. Indeed, on the basis of Shannon radii, cation ionic radii may be computed, for coordination numbers of 8, or 9, and consequently the evolution of formation constants, for these complexes, may be plotted as a function of  $z/r$  en.

As regards the An(IV) case, the coordination number for Np(IV) and Pu(IV) is commonly found to be 8. With the assumption that the same goes for U(IV) and Th(IV), the evolution of  $\log K$ , as a function of  $1/r_8$ , is not linear. In the event of Th(IV) and U(IV) exhibiting a coordination number of 9, the alignment with Np(IV) and Pu(IV) would be more satisfactory.

This evolution corroborates the findings obtained by way of structural investigation techniques. As regards the complex of 1:2 stoichiometry, in particular, a coordination number of 8 for Np(IV) and Pu(IV) implies that the metal cation is bonded in quadridentate fashion with each NTA ligand. This entails that each NTA ligand is bound to the cation by way of its three carboxylate functions, but also through its nitrogen atom. A coordination number of 9 for Th(IV) and U(IV) indicates one further bond in the complex, e.g. with a water molecule in the first coordination sphere.

The coupling of two complementary approaches – the thermodynamic, and structural approach – together with a number of techniques has allowed a better description to be arrived at, of An(IV) behavior in the presence of NTA, this being used as a DTPA ligand simulant.

The formation constants for An(IV) and NTA complexes of stoichiometries 1:1 and 1:2, as determined in this investigation, may be compared with one another, owing to the similar experimental conditions used for each actinide.

With respect to the structural investigation, the various data obtained show, on the one hand, that the cation coordination number, in the  $[\text{An}(\text{IV})\text{-NTA}_2]$  complex, varies as one progresses along the actinide series. Thus, while  $\text{NC} = 8$  for Pu(IV) and Np(IV),  $\text{NC} = 9$  in the case of Th(IV), and probably for U(IV), which may be accounted for by the presence of a water molecule in the first coordination sphere, while, at the same time, the nitrogen atom plays a part in the bond between cation and ligand: the latter is thus quadridentate.

As regards actinides in oxidation state +VI, the hydrolysis mechanism involved is similar for uranium, neptunium, and plutonium, this accounting for there being quite good knowledge of the phenomenon. For plutonium, the pH value for onset of hydrolysis lies at about 3.5, corresponding to a complex of 1:1 stoichiometry, for dilute solutions involving trace concentrations. At higher pH values, actinides in oxidation state +VI undergo polymerization, only the first units (complexes of 2:2 or 3:5 stoichiometry) having been unambiguously identified.

Actinides in oxidation state +IV are found to predominate, in  $An^{4+}$  form, only in highly acidic media (involving  $H^+$  concentrations higher than 0.5 M). The products yielded by hydrolysis comprise, in most cases by far, polymerized products. Two phenomena further exacerbate this complexity. On the one hand, such polymerization reactions are complex, currently not being amenable to representation by means of a simple model; and, on the other hand, the polymer chains formed in solution undergo evolution to a colloidal form. Finally, it should be noted that the hydrolysis products are, on the one hand, chemically inert, and, on the other hand, that they yield, over time, a solid, hydrated oxide compound. Thus, the only quantitative data available, for the purposes of characterizing plutonium hydrolysis, were obtained for that element in trace concentrations. Finally, it is crucial to note that plutonium(IV) tetrahydroxide is a compound exhibiting very low solubility. The solubility product, for the freshly prepared compound, has been estimated at about  $10^{-55}$ .

In nitric acid media, it was found that, for 0.1 M proton acidity, disproportionation occurs of Pu(IV) and Pu(V), to Pu(III) and Pu(VI), together with Pu(IV) polymerization, owing to hydrolysis. Polymerization rate increases with temperature, time, presence of other ions in the solution, and, most crucially, plutonium concentration. These phenomena, which are controlled with great difficulty, have led to stipulating handling only solutions of acidity higher than 0.5 M in proton terms, for all nuclear fuel treatment operations involving plutonium.

## Complexation in aqueous solution: the general case

In aqueous solution, many complexes are found to occur, involving 5f ions. The stability of such complexes depends, to a large extent, on the ion's oxidation state. As a rule, the order of stability for these complexes differs very little from that found in the hydrolysis case:  $Pu^{4+} > Pu^{3+} > PuO_2^{2+} > PuO_2^+$ . The inversion seen to occur between  $Pu^{3+}$  and  $PuO_2^{2+}$  chiefly relates to the steric constraint, arising from actinyl ion accessibility being restricted to the equatorial plane; and, in some cases, is due to ligand steric bulk. The bonds involved being mainly of the ionic type, the more stable complexes are obtained with hard base-type ligands. Thus, for the halide series, the following order of stability obtains:  $F^- > Cl^- > Br^- > I^-$ . It is indeed the con-

siderable ability, exhibited by fluoride ions, to form complexes with actinide ions that allow such ions to be stabilized in oxidation state +VI, in the form of an octahedral  $MF_6$  complex, without involving the formation of the *trans*-dioxo  $MO_2^{2+}$  unit. After fluoride ions, oxygenated ligands yield the most stable complexes. The nature of actinide complexes, as inner- or outer-sphere complexes, i.e. according to whether ligand and metal are directly in contact, or are kept apart by a layer of water molecules, is increasingly being targeted by investigations. However, no predictive model is available as yet, allowing a reasoned choice to be made as to the most suitable complexants, or extractants, for separation purposes.

As regards the specific case of ions from the actinide, and lanthanide families, it should be noted that superimposing an extraction system (whether solid-liquid, or liquid-liquid) onto complexation in the aqueous phase affords considerable potential as regards separating – within, or between families – ions in oxidation state +III. It should be noted that opting for ligands featuring a donor atom that is relatively softer, in Pearson's sense, than oxygen yields better separation results. Donor atoms, in the ligands used for such separation operations, are most commonly chlorine or nitrogen atoms, or even sulfur atoms. Separation efficiency will then be dependent on the difference in stability exhibited by the complexes formed in aqueous solution. For instance, initial An(III)–Ln(III) separations (inter-family separation) were carried out with ion-exchange resins, and a complexing medium. As regards one of these operations, separation of americium from promethium was effected across a cation-exchange resin, using chloride ions, at high concentration, as complexant. In the second operation, An(III)–Ln(III) separation was effected by means of an anion-exchange resin, using thiocyanate ions ( $SCN^-$ ) as complexant. As regards intra-family (i.e. within one family) separation, a ligand involving a hydroxy function in the alpha position of a carboxylic function ( $\alpha$ -hydroxybutyric acid:  $\alpha$ -HIBA) is the one most widely used, in association with a cation-exchange resin. It should be noted that heavy actinide element purification, as carried out in the United States, at Oak Ridge National Laboratory, is based on these principles: anion exchange in a concentrated hydrochloric acid medium for Am–Cm separation, and cation exchange in the presence of the  $\alpha$ -HIBA ligand for Bk–Cf–Es–Fm separation. Before going on to present three examples of actinide ion complexation in the aqueous phase, it should be pointed out that the approaches developed for An(III)–Ln(III) separation operations derive from these investigations, i.e. they are based on the use of donor atoms such as sulfur, or nitrogen. These act as complexants in the aqueous phase, extractants in an organic phase. Figures 13 and 14 show the speciation of actinides in oxidation state +III [Am(III) and Pu(III)], drawing on techniques adapted for the nuclear environment, such as electrospray-ionization mass spectrometry, and microcalorimetry.

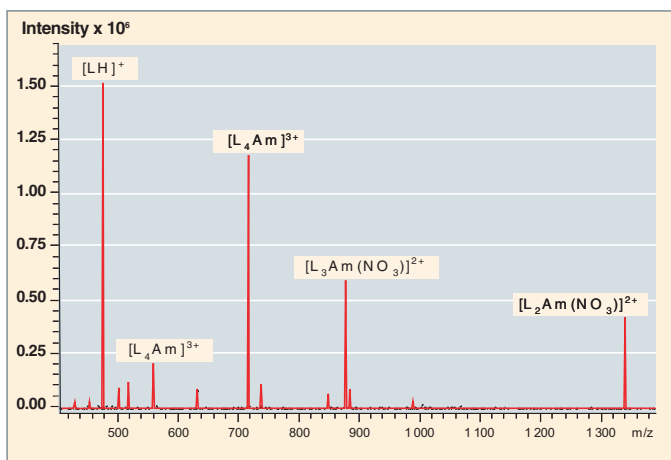

Fig. 13. Electrospray-ionization mass spectrum (ESI-MS) of americium(III) complexes ( $[Am] = 4 \cdot 10^{-4} M$ ) with a ligand (L) of the malonamide family ( $L = \text{DMDOHEMA}^+$ ,  $[L] = 8 \cdot 10^{-4} M$ ).

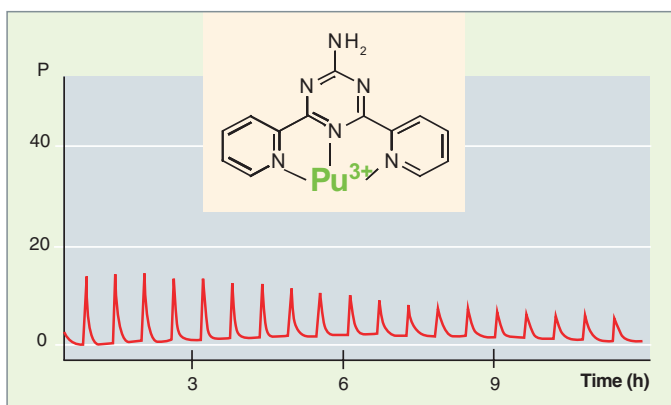

Fig. 14. Normalized thermogram, obtained by microcalorimetry, of successive titrations of plutonium(III) by the ligand 2-amino-4,6-di-(pyridin-2-yl)-1,3,5-triazine (ADPTZ) in a 75/25% MeOH-water mixture (obtained in ATALANTE).

## Nitrate ions

First, it should be noted that the choice of nitric acid as reaction medium, for all nuclear fuel treatment operations, is based on the redox, acidobasic, and complexing properties exhibited by this acid. Indeed, in a nitric acid medium, controlling the presence, or otherwise, of nitrous acid (entering into an equilibrium with volatile nitrogen oxides  $\text{NO}_x$ ), by means of antinitrous agents, allows the oxidation state to be controlled, for cations in oxidation state +IV (U, Np, Pu). At the same time, the moderate redox properties thus exhibited allow, on the one hand, rapid and complete dissolution of oxide-type nuclear fuels; and, on the other, make it possible to curb corrosion phenomena in industrial facilities, due to this mineral acid. Complementing these redox properties, nitric acid stands as an acid of medium strength, and, while a major fraction of nitric acid becomes dissociated, in aqueous solution, a fraction does remain in molecular form. This property is especially useful,

as it allows the recycling of nitric acid, thus minimizing the yield of process waste. Finally, the complexing properties of nitrate ions are particularly suitable, as they make it possible, on the one hand, to achieve very high salt solubility – favoring the use of concentrated solutions, thus allowing process equipment volume to be minimized – while allowing, on the other hand, control of extraction, and back-extraction, by tributyl phosphate (TBP), of neutral actinide nitrate complexes (see Fig. 15). Indeed, extraction, and, most crucially, back-extraction of actinide ions by TBP are readily controlled, by setting the concentration of nitrate ions in the aqueous solution, at thermodynamic equilibrium levels with the organic phase.

While this last property is probably the most important one, it should be admitted that, given the current state of our knowledge, it is not as yet feasible to model altogether accurately actinide ion complexation phenomena involving nitrate ions. In particular, it is not possible, currently, to predict whether nitrate ions will behave as monodentate, or bidentate ligands, or whether these ligands will form inner-, or outer-sphere complexes. On the other hand, it is well known that nitrate ions yield complexes, with actinides in oxidation state +IV, of stoichiometry ranging from 1 to 6. Of these, the higher complexes –  $[\text{Pu}(\text{NO}_3)_5]^-$  and  $[\text{Pu}(\text{NO}_3)_6]^{2-}$  – are anionic, forming the basis for the most widespread, and most effective, plutonium purification method, across anion-exchange devices. As regards the lower nitrate complexes, these are of great practical importance, as they make it possible to stabilize plutonium in oxidation state +IV, during dissolution operations. Finally, the plutonium(IV) tetranitrate complex is of crucial importance for the PUREX process, as this is the main species extracted to the organic phase by TBP.

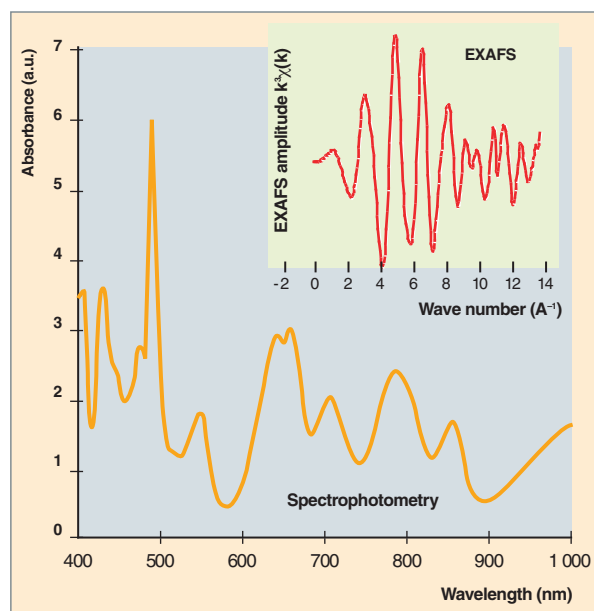

Fig. 15. Spectrophotometry, and EXAFS spectrum at level LIII for the plutonium(IV) tetranitrate complex, in a tributyl phosphate solvate, diluted in dodecane.

## Peroxo ions

While complexation of actinide ions by dihydrogen peroxide ( $\text{H}_2\text{O}_2$ ) is, in effect, no longer in use on an industrial basis, it will be useful to cover some aspects of this process, since this example allows the full range of actinide ion reactivity to be highlighted. Moreover, it should not be forgotten that the radioactive properties exhibited by actinides are liable to result in formation of dihydrogen peroxide in solutions. This compound exhibits – as indeed most chemical reactants do – acidobasic, redox, and complexing properties. The most strongly basic form of  $\text{H}_2\text{O}_2$  is  $\text{O}_2^{2-}$ , this indeed being the complexing form.  $\text{H}_2\text{O}_2$  acts both as an oxidizing agent, its potential standing at about 1.77 V/SHE, and as a reducing agent, with a potential of about 0.68 V/SHE. Thus, in acidic media, reduction of Pu(IV) by  $\text{H}_2\text{O}_2$ , and oxidation of Pu(III), also by  $\text{H}_2\text{O}_2$ , result in a stationary state being achieved, with both oxidation states standing in equilibrium. As regards complexation by  $\text{O}_2^{2-}$  ions, it is well known that three successive Pu(IV) complexes may be formed, in aqueous solution, with stoichiometries of 2:1, 1:1, and 1:2 ( $[\text{Pu}_2(\text{O}_2)\text{OH}]^{3+}$ ,  $[\text{Pu}_2(\text{O}_2)_2]^{4+}$ ,  $[\text{Pu}(\text{O}_2)_2]$ ). The complex of 1:2 stoichiometry carries no charge, resulting in low solubility, in aqueous solution. This chemical behavior was put to advantage, at an earlier time, in the preparation of plutonium dioxide, subsequent to calcination of the plutonium(IV) peroxo complex. However, the unwanted reduction of Pu(IV) to Pu(III) results in a mixture being obtained, consisting of  $[\text{Pu}(\text{O}_2)_2]$  and  $[\text{Pu}_4(\text{O}_2)_7]$  complexes, the latter being a mixed Pu(IV) and Pu(III) complex. As regards the particular case of U(VI), which is not amenable to reduction by  $\text{H}_2\text{O}_2$ , it is well known that complexation yields a neutral complex,  $[\text{UO}_2(\text{O}_2)]$ , of low solubility, this yielding  $\text{UO}_2$ , by calcination.

## Oxalato ions

As was the case with dihydrogen peroxide, it will be useful to look into the acidobasic, redox, and complexing properties exhibited by oxalic acid. Oxalic acid is a diacid, the most basic form of which is **bidentate\***. This property of oxalate ions means they are able to form bridging bonds between the various entities that are found, in particular, in solid compounds. As regards actinide ions in oxidation states +III, +IV, complexation by oxalate ions results in formation of a multiplicity of complexes, of stoichiometries ranging from 1:1 to 1:4. The 1:4 stoichiometry corresponds, indeed, to saturation of the coordination sphere ( $\text{CN} = 8$ ) for plutonium in oxidation state +IV. Owing to the acidobasic properties exhibited by oxalic acid, and actinide ions, the driving force, in the complexation reaction involving oxalato ions, is competition between protons ( $\text{H}^+$ ) and actinide  $\text{An}^{4+}$ , or  $\text{An}^{3+}$  cations. Of the various complexes, those of stoichiometries 1:2, and 2:3, involving actinide ions in oxidation states +IV, +III respectively, are neutral, and thus sparingly soluble in the aqueous phase. Thus, actinide ion solubility is controlled by adjusting nitric acidity, and oxalic acid concentration in solutions.

## A description of concentrated solutions by means of molecular dynamics?

Application of the concepts of analytical chemistry has allowed many chemical operations to be controlled in solutions. In the context of chemical analysis, changing the medium makes it possible, in most cases, to enhance the behavior of the species being dosed, in the medium stipulated by the analyst. On the other hand, an industrial process, such as the nuclear fuel treatment process, entails as a rule the use of concentrated solutions. In such conditions, reactivity, for the element that is to be controlled, shows considerable variation, compared with what would obtain in dilute solution. This difficulty, sidestepped as it currently is by way of interpolation and/or extrapolation functions, precludes however any quantitative prediction being made as to the behavior exhibited by a species, in a complex medium for which there is a lack of experimental data. For instance, even though the formation may easily be observed, of various higher nitrate Pu(IV) complexes, no research work has warranted any formal corroboration of the values for the complexation constants found in the literature. Indeed, the nitrate ligand's complexing power being poor, this entails working at high concentrations, precluding determination of these constants if no account is taken of the phenomena linked to such departure from the ideal case.

To describe the medium's effect on the thermodynamic activity ( $a_i$ ) of species  $i$  in solution, the **activity\*** coefficient ( $\gamma_i$ ) is evaluated, this being related to concentration ( $C_i$ ) by the relation:  $a_i = \gamma_i \cdot C_i$ . After many attempts to arrive at theoretical expressions for the  $\gamma_i$  coefficients, physical chemists were compelled to consider empirical terms, or to cater for effects from the medium in global fashion, without attempting to ascribe them to any well-defined physical interaction. As regards actinides, for which obtaining thermodynamic data is fraught with difficulties, available data are scarce. To get around such difficulties, "simulants" are used, on a regular basis (to avoid the constraints related to high radioactivity). By way of example, Th(IV), U(VI), and lanthanides(III) are the species selected in order to simulate all actinide ions (IV), (VI), and (III), respectively.

Better control of effects induced by the medium, for the purposes of quantifying actinide ion behavior, is thus seen to be crucial, particularly from a theoretical standpoint. In the present Box, we have elected to outline the binding mean spherical approximation (BIMSA) theory, especially as regards the advantages afforded by coupling this theory with molecular dynamics (MD). Indeed, the BIMSA theory, based as it is on statistical mechanics, makes it possible, on the basis of a representation of solutions at the microscopic level, and a set of parameters, to compute osmotic coefficients (and thus activity coefficients), right up to high concentrations. These parameters, having a physical meaning as they do, may be determined by other methods, such as molecular dynamics.

In the BIMSA theory, ions are treated, together with their hydration layer, as charge-bearing, hard spheres, of diameter  $\sigma^*$  (or  $\sigma$ ). The model takes into account complex formation, and the evolution of medium permittivity  $\epsilon$  with electrolyte concentration. Finally, the diameter of the hydrated cation is assumed to vary in linear fashion with salt concentration  $C_S$ :  $\sigma^* = \sigma^{(0)} + \sigma^{(1)} C_S$ .

Ultimately, the hope is that the BIMSA theory may be used in predictive fashion, for the computation of thermodynamic properties of actinide salt solutions. For that purpose, however, values for the microscopic parameters must be provided, on the basis of other methods. BIMSA microscopic parameters  $\sigma^{(0)}$  and  $\sigma^{(1)}$  (i.e., the diameter of the hydrated cation, at infinite dilution; and the fitting parameter for hydrated cation diameter change with concentration, respectively), deriving as they do from the structural environment in close vicinity to the cation, are variables that may be determined, in particular by way of molecular dynamics (MD) simulations. It is in this context that investigations were carried out with aqueous solutions of dysprosium(III) chloride.

As a first step, the BIMSA theory allowed experimental osmotic coefficients for dysprosium salts, as found in the literature, to be reproduced, up to high concentration, including that for  $\text{DyCl}_3$  (see Fig. 16).

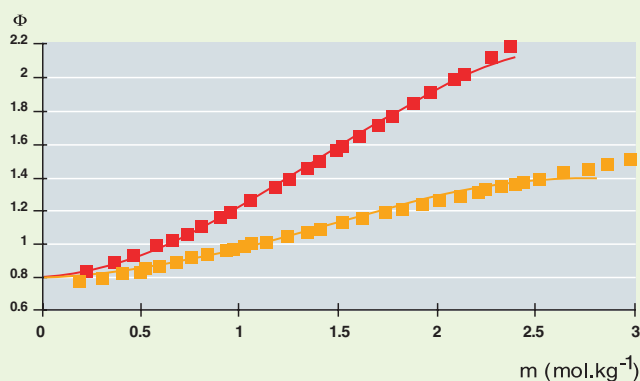

Fig. 16. Experimental osmotic coefficients [ $\text{DyCl}_3$  (■),  $\text{Dy(NO}_3)_3$  (■)] and as computed with the BIMSA theory, after optimization of microscopic parameters (line curves).

The set of parameters yielding this model proved consistent with experimental findings. The various optimized microscopic parameters had the values:  $\sigma^{(0)} = 0.951$  nm, and  $\sigma^{(1)} = -71.6 \cdot 10^{-9}$  nm·mol<sup>-1</sup>·L. The value for  $\sigma^{(0)}$  is very close to the only value that has been put forward in the literature, evaluated at 0.950 nm. Parameter  $\sigma^{(1)}$  is not readily comparable with experimental data. It reflects the change in hydration sphere diameter with concentration, this on the other hand being amenable to computation by means of molecular dynamics.

A number of simulations, ranging from a dilute medium (0.05 mol.kg<sup>-1</sup>) to a highly concentrated one (3.1 mol.kg<sup>-1</sup>), were carried out.

In all such simulations, the first coordination sphere for  $\text{Dy}^{3+}$  remains unaltered, featuring no  $\text{Cl}^-$  ion, and comprising 8 water molecules, with oxygen atoms distant 0.237 nm from the  $\text{Dy}^{3+}$  ion, in agreement with experimental findings likewise obtained during this investigation. In the 3.1 mol.kg<sup>-1</sup> concentration case, just 18 water molecules remain for one  $\text{DyCl}_3$  entity. With such a high proportion of  $\text{Dy}^{3+}$  and  $\text{Cl}^-$  ions, the presence of  $\text{DyCl}_2^+$  ion pairs might have been anticipated; this however is not found to occur.

The second coordination sphere for  $\text{Dy}^{3+}$  comprises water molecules, and  $\text{Cl}^-$  ions. The distance between the  $\text{Dy}^{3+}$  ion and these molecules likewise remains unaltered as solution concentration varies, which, at first blush, seems to be at variance with the decrease in “hydrated cation” diameter, as featured in the BIMSA model.

Average hydrated cation diameters were estimated on the basis of the volumes accessible to the solvent in clusters comprising one  $\text{Dy}^{3+}$  ion with its first two hydration spheres, less the  $\text{Cl}^-$  ions. The average diameter for such clusters, at low concentration, stands in reasonable agreement with BIMSA parameter  $\sigma^{(0)}$ , bearing in mind the subjective character of molecular volume computations (from which the diameters are derived). Further, this diameter decreases as concentration rises. This decrease in average diameter is due to an increased number of  $\text{Cl}^-$  ions, and thus a decrease in water molecule numbers in the second coordination sphere for  $\text{Dy}^{3+}$ . This decrease then agrees with that yielded by adjustment of the BIMSA parameters (see Fig. 16).

Thus, molecular dynamics yields structural information that is compatible with that used in the BIMSA model. Such computations allow a determination, and interpretation to be arrived at for parameter  $\sigma^{(1)}$ , that would not be directly achievable by other methods. The decrease in hydrated cation diameter  $\sigma^*$ , indeed, is not correlated with any evolution in the distance between the cation and water molecules, rather it is correlated with a decrease in the number of water molecules in the “hydrated cation” entity. Determination of the value for this parameter further tells us that this evolution occurs according to a polynomial law.

The idea is therefore to use MD as one of the methods (as an adjunct to experimental data acquisition) that will allow data to be provided, at the microscopic level, to enhance the BIMSA theory, together with use of the latter theory, for predictive purposes. If more quantitative information is to be gained, some aspects will require further investigation, in particular through development of the models used in molecular dynamics, and optimized determination of the BIMSA parameters yielded by such simulations.

Calcination in air of the insoluble oxalato compounds of elements neptunium, plutonium, and americium yields  $AnO_2$  dioxides. Finally, as precipitation of such oxalate salts allows the partitioning of actinides from other elements, this technique is universally employed, whether in laboratories or in the nuclear industry, for the final operations, yielding pure, solid actinide compounds.

While no redox potential is available in the literature, it is known that the reduction of Np(VI) to Np(V), and subsequently to Np(IV), as of Pu(VI) to Pu(IV), by oxalic acid exhibit very slow kinetics, at ambient temperature, in an acidic medium. On the other hand, at high temperature, e.g. when oxalato compounds are transformed into dioxides, the reducing properties of oxalate ions are well known, both with regard to Pu(VI), and Pu(IV).

**Philippe MOISY and Christophe DEN AUWER,**  
*Radiochemistry and Processes Department*

## Conclusion, and prospects

It is thus apparent that the actinide element family exhibits physicochemical properties such as to entail a particularly rich diversity of chemical forms for these elements. As an aside to the main thrust of the present chapter, it should further be pointed out that solid-state chemistry (pure metals, alloys, ceramic compounds, etc.) likewise allows compounds to be formed, with these elements, exhibiting specific properties. Such diversity directly stems from the properties of the 5f and 6d orbitals, these being proportionately more delocalized than their 4f counterparts. It thus appears there is a need, in particular, to gain an understanding of the frontier orbitals, in order to improve control of the underlying processes, in actinide complexation chemistry. For that purpose, an ever growing effort has focused on probe techniques, and coupling these with the modern tools available to theoretical chemistry. Be that as it may, the fact remains that our overall understanding of the very nature of the actinide–ligand bond is still limited as yet.

Thus, in aqueous solution, this being the medium for which the state of the art is at its most complete, it should clearly be stated that the description of “light” actinide chemical behavior is not as yet completed, this resulting in modeling difficulties. Nevertheless, it is such mastering of these elements’ physicochemical behavior that is to open up the broadest prospects, for the new partitioning processes. It will thus be seen how great a challenge is set by actinide solution chemistry (whether thermodynamic, kinetic, or structural), for modern physicochemistry, since a description of the behavior of such so-called heavy elements stands as the foundation for future spent fuel treatment, and actinide recycling processes.

### ► Bibliography

Lester R. MORSS, Norman M. EDELSTEIN, Jean FUGER (eds.), Joseph J. KATZ (Honorary Editor), *The Chemistry of the Actinide and Transactinide Elements* (3rd edition), Springer, 2006.

“Chemical thermodynamics” (series edited under the aegis of OECD–Nuclear Energy Agency [NEA]), Elsevier BV, The Netherlands.

Charles MADIC, “Le plutonium – une brève introduction à ses propriétés nucléaires et physicochimiques”, *Revue générale nucléaire*, 1995, No. 1, pp. 7–13.

Bernard FERNANDEZ, *De l’atome au noyau, Une approche historique de la physique atomique et de la physique nucléaire*, Paris, Ellipses, 2006.

**Philippe MOISY and Christophe DEN AUWER,**  
*Radiochemistry and Processes Department*

With contributions from Claude BERTHON, Laurence BERTHON, Lucie BONIN, Émilie BOSSÉ, Marie-Christine CHARBONNEL, Philippe GUILBAUD, Dominique GUILLAUMONT, Manuel MIGUIRDITCHIAN, Alexandre RUAS, Christian SOREL, and Laurent VENAULT,  
*Radiochemistry and Processes Department*





## Overview of treatment processes

### Historical background

While the prime purpose of spent nuclear fuel treatment, nowadays, is to achieve savings in terms of raw materials, such was not always the case: originally, reprocessing (this being the term in common usage, as in the phrase “spent fuel reprocessing”) processes were developed to ensure production of plutonium for military purposes.

#### A terminological point more significant than might appear: “treatment”/“reprocessing”

The term generally used, historically, has been “reprocessing” (in French: “*retraitement*”).

One officially-sanctioned definition, as published in the nuclear engineering vocabulary issued under the auspices of the French government’s Terminology Commission, in 2006, runs as follows: “*retraitement*” (reprocessing): the treatment of spent fuels, to extract fissile, and fertile materials, in order to allow their reuse; and to condition the various kinds of waste in a form suitable for disposal.” As will be seen, the word covers a number of meanings: chemical treatment, to partition the materials, this being related to the recycling of materials recoverable for further value-added purposes, whether civil, or military; and further related to waste management. Since the early 2000s, the parlance has been that of “treatment” (French: “*traitement*”), in order to differentiate clearly this operation from any subsequent use involving such materials: be it **recycling\*** (as an option), or waste **conditioning\***. It is this more recent term that will be used hereafter, throughout this Monograph.

The first process to be deployed was the bismuth phosphate process, used in the Hanford (Washington) plant, in the United States, as early as 1945, i.e. less than five years after pluto-

nium had been discovered, by G. T. Seaborg. This involved the formation, in the nitric dissolution solution, of a bismuth phosphate precipitate, carrying the plutonium with it. The precipitate then underwent separation, by centrifugation. This discontinuous operation had to be repeated several times over, to achieve the required purity. The process was not the most efficient one, in industrial terms, however this choice had been dictated by the pressing need to cut leadtimes, and take as few technical risks as possible.

After the war, the adoption of solvent extraction as separation method marked a decisive turning point. Indeed, this method allows continuous operations, making it possible to achieve high separation factors in a limited number of steps. Most organic solvents then available were tested, and new plants using these processes came on stream (see Table 2).

The Trigly process, developed in Canada and the United Kingdom, made use of triethylene glycol dichloride (or triglycol dichloride: hence the process name). It was used on a semi-industrial scale at Chalk River (Ontario, Canada), as early as 1945, being abandoned in 1954 owing to its complexity.

The Redox process employed hexone (methyl isobutyl ketone), using oxidation–reduction reactions (hence the name). A plant was operated at Hanford, in the United States, from 1952 to 1960.

The BUTEX process, used in the first plant operated at Windscale (now Sellafield), in the United Kingdom, from 1952 to 1964, was based on use of dibutyl carbitol (a trade name for  $\beta,\beta'$ -dibutoxy diethyl ether).

Table 2.

Industrial treatment processes.				
Process name	Main extraction product	Chemical formula	Plant	Commissioned
Bismuth phosphate	Bismuth phosphate (*)	$\text{BiPO}_4$	Hanford (United States)	1945
Trigly	Triethylene glycol dichloride	$\text{Cl}(\text{C}_2\text{H}_4\text{O})_2\text{C}_2\text{H}_4\text{Cl}$	Chalk River (†) (Canada)	1949
Redox	Methyl isobutyl ketone	$\text{CH}_3\text{COC}_4\text{H}_9$	Hanford (United States)	1952
BUTEX	Dibutyl carbitol	$\text{C}_4\text{H}_9\text{O}(\text{C}_2\text{H}_4\text{O})_2\text{C}_4\text{H}_9$	Windscale (United Kingdom)	1954
PUREX	Tributyl phosphate	$\text{O}=\text{P}(\text{OC}_4\text{H}_7)_3$	Savannah River (United States)	1954
			Hanford (United States)	1956
			UP1 (France)	1958
			Windscale (United Kingdom)	1964

(\*) Precipitation method

(†) Semi-industrial scale

The PUREX process (this being the acronym for “plutonium uranium refining by extraction”), developed as early as 1945, was first deployed industrially in 1954, at the Savannah River (South Carolina) plant, in the United States. It was taken up at Hanford in 1956, and at Windscale in 1964. In France, this was the only process to be used on an industrial basis. This process, involving use of tri-*n*-butyl phosphate – usually simply referred to as tributyl phosphate (TBP) – diluted in a petroleum cut (kerosene, dodecane...), soon made its mark, supplanting all other processes.

## The French background

The first milligram of plutonium to be extracted in France, in 1949, came from the laboratories at the Le Bouchet plant (near Paris), this being obtained from fuel irradiated in the ZOE pile, at Fontenay-aux-Roses (likewise near Paris). An initial pilot plant, already using the PUREX process, came on stream in 1954 at the Châtillon Fort site, also at Fontenay-aux-Roses. This made it possible to validate the options selected for the first plant, UP1.

The first French industrial plant, UP1, originally dedicated to spent fuel treatment for fuel from graphite–gas (carbon dioxide), plutonium-breeder reactors G1, G2, G3, came on stream at Marcoule, in southern France, in 1958. With a capacity of 800 t/year, the plant was kept in operation, in particular for the purposes of spent fuel treatment for the **UNGG\*** power reactors in the EDF fleet, up to 1997. In 1966, a second industrial plant was commissioned, at the La Hague site, in western France: UP2. Intended initially for UNGG fuel treatment, this plant was fitted in 1976 with a new “head-end” workshop, the HAO (Haute Activité oxyde: High-activity Oxide) unit, allowing treatment of up to 400 t/year of fuels from light (ordinary)-water reactors; hence the name for the plant: UP2-400. Up to 1987, when metal fuel treatment was solely taken over by the UP1 plant, at Marcoule, UP2-400 was operated on the basis of alternate campaigns, with metal (UNGG), and oxide (**UOX\***, and **MOX\***) fuels. From 1988 to 1994, UP2-400 was wholly dedicated to oxide fuel treatment. From 1990, the UP3 plant came on stream, at the La Hague site, with a capacity of 800 t/year, this being earmarked, for the first 10 years, for treatment of fuels (both **PWR\*** and **BWR\*** fuels) from customers

outside France. In 1992, UP2 capacity was increased to 800 tHM/year, by adding new workshops (the plant being renamed UP2-800), to cater for treatment of fuels from EDF’s pressurized-water power reactors. From 2001, the two plants, UP3 and UP2-800, which had initially been completely separate and independently operated, were partially interconnected, to form a single industrial complex. As stipulated by the French edicts issued in January 2003, individual nominal capacity, for each of these plants, was increased to 1,000 t/year, overall capacity for the two plants remaining restricted to 1,700 t/year.

Operating alongside these large-capacity industrial installations, two pilot workshops (ATI, and APM) were set up (see Table 3). The ATI unit (Atelier de traitement des combustibles irradiés: Irradiated Fuel Treatment Workshop), with a capacity of 1 kg/d, carried out treatment, on an experimental basis, from 1969 to 1979, of the first oxide fuels from the fast-neutron reactor line (mainly from the RAPSODIE reactor). APM (Atelier pilote de Marcoule: Marcoule Pilot Workshop), commissioned in 1962, went through, over its 35 years’ operation (1962–97), three major phases. The first phase (1962–73) featured highly diversified operations: a campaign of UNGG (EDF) fuel treatment, campaigns involving very highly irradiated PuAl and UAl fuels, a thorium fuel treatment campaign... The second phase (1974–94) was wholly devoted to oxide fuel treatment, whether from the fast-neutron reactor line (chiefly from the Phénix reactor), or the light-water reactor line (UOX and MOX campaign, in support of the startup of the UP3 and UP2-800 plants). The final phase (1994–97) corresponded to treatment of CEA fuels of no further use (axial and radial blankets from the RAPSODIE reactor, research reactor plate fuels...).

## Principles and purposes of the PUREX process

The PUREX process, as used nowadays, meets the following purposes: recovering, with the highest efficiencies feasible, the plutonium and uranium contained in spent fuels, and purifying them so that they may be reused; conditioning the various kinds of waste in a form compatible with disposal, while involving the lowest possible environmental impact.

Table 3.

French treatment installations						
Plant	Site	Operator	Capacity	Startup	Fuels	Shutdown
UP1	Marcoule	Areva	800 t/year	1958	metal	1997
APM	Marcoule	CEA	5 t/year	1962	metal, oxide	1997
UP2	La Hague	Areva	800 t/year	1966	metal	1987
AT1	La Hague	CEA	1 kg/d	1969	oxide (fast reactors)	1978
UP2-400	La Hague	Areva	400 t/year	1976	oxide	1994
UP3	La Hague	Areva	800 t/year	1990	oxide	–
UP2-800	La Hague	Areva	800 t/year	1994	oxide	–

In the plants currently operated in France, reprocessed uranium (**RepU\***) is delivered, as a rule, in the form of a concentrated (300–400 g/l) uranyl nitrate solution, allowing its subsequent **conversion\***, into oxides ( $\text{UO}_2$ , or  $\text{U}_3\text{O}_8$ ), or fluorides ( $\text{UF}_4$ ,  $\text{UF}_6$ ), depending on destination (storage, fuel fabrication, or isotopic enrichment). Plutonium is delivered by the plants in solid dioxide form ( $\text{PuO}_2$ ), to allow transport of the substance.

The PUREX process involves an initial step of nitric dissolution of the uranium, and plutonium (along with the other actinides, and most fission products), with subsequent uranium and plutonium partitioning, and purification, by means of liquid–liquid extraction techniques, using as **extractant\*** TBP, diluted in an organic solvent, hydrogenated tetrapropylene (HTP) being used in French plants. Associated with these main operations, further operations allow nitric acid and solvent (TBP, HTP) recycling, and treatment of liquid, and gaseous **effluents\***, and solid waste. The main steps in the process, as shown in the schematic in Figure 17, include:

- process head-end operations, making it possible to yield, starting with the fuel assembly, a clear nitric solution, containing nearly all of the initial uranium, and plutonium;

- core process operations, these allowing, by way of extraction–back-extraction (stripping) cycles, purified uranyl nitrate and plutonium nitrate to be obtained (this phase is usually also understood to cover nitric acid and solvent recycling operations);

- conversion operations, as a rule restricted to conversion of plutonium nitrate to oxide form;

- ancillary treatment operations, for the various liquid or gaseous effluents, and solid waste, yielded by the main operations. Such operations include, in particular, fission product **vitrification\***, and structural waste compaction.

### Operation of the PUREX process

In the plants currently operated at the La Hague site, UP3 and UP2-800, achieving large treatment capacities required development of equipment operating in continuous, or cascade mode. This was the case, in particular, as regards:

- dissolution, with the rotating wheel dissolver;
- solvent extraction operations, involving use of pulsed columns for the initial extraction cycle (adoption of an annu-

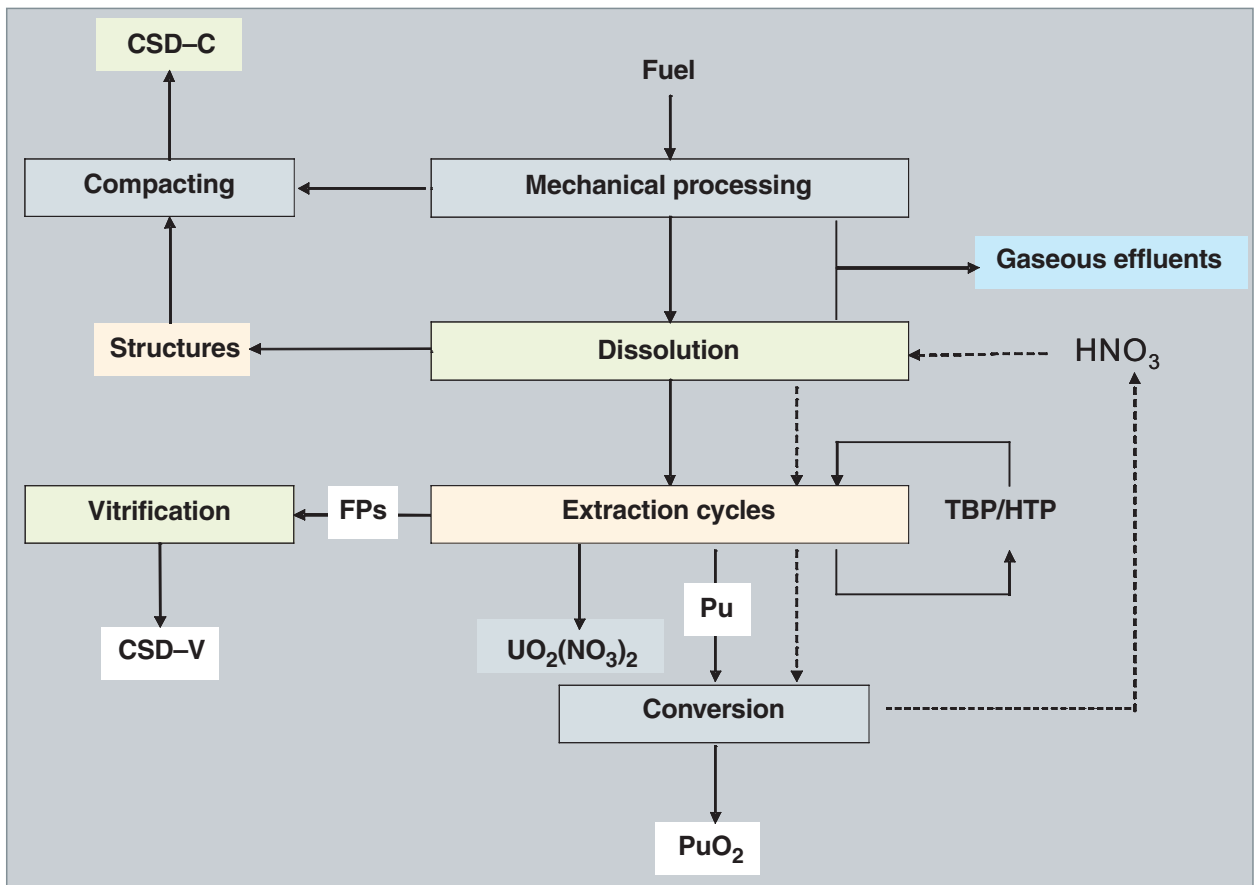

Fig. 17. The main steps in the PUREX process.

lar geometry precluding **criticality\*** risks), and centrifugal extractors in a plutonium purification cycle (such equipment, involving a **sub-critical\*** geometry, precludes any risk of criticality, and, owing to the very short dwell time involved, allows solvent degradation to be limited).

In these plants, bringing down the number of purification cycles was achieved by carrying out uranium–plutonium partitioning (i.e. splitting the streams), as early as the first extraction cycle. This further allows a decoupling, at the earliest opportunity, of plutonium-related safety–criticality constraints from those stemming from the large uranium stream undergoing treatment.

### The PUREX process: an operational balance sheet

As of the end of Semester 1 2007, total amounts of fuels having undergone treatment in French installations approximately amounted to:

- 23 500 tonnes UNGG fuels, mostly treated in UP1;
- 23 300 tonnes UOX fuels, from light-water power reactors (some 4,400 t in UP2-400, 9,900 t in UP3, and 9,000 t in UP2-800);
- 23.3 tonnes MOX fuels from light-water power reactors (9.6 t in UP2-400, 2.1 t in APM, 10.6 t in UP2-800);
- 27 tonnes MOX fuels yielded by fast reactors (about 1 t in AT1, 10 t in UP2-400, 16 t in APM).

The PUREX process, as used in the current plants at La Hague, allows:

- recyclable products – uranium, and plutonium – to be obtained at very high purity (involving a **decontamination factor\*** of some  $10^7$ – $10^8$ ); and considerable recovery efficiencies to be achieved (higher than 99.8%);
- low-volume conditioning of virtually all fission products and minor actinides, in glass matrices;
- low-volume conditioning, after compacting, of structural waste, and higher-activity-level technological waste yielded by process operation.

### Prospects for future evolution

From the time of its initial deployment, the PUREX process has undergone constant evolution, while retaining its main features. Such evolution is mainly due to:

- evolution as regard fuels, involving ever increasing burnups, and increased introduction of MOX fuels;
- the desire to bring down volumes, as far as feasible, as regards waste, and discharges into the environment;
- the constant concern for improved safety;
- the aim, as in any industry, of putting extant installations to best advantage, to cut down on operating costs.

**Aimé Vaudano,**  
*Radiochemistry and Processes Department*

## Some characteristics of nuclear fuels, relevant for their treatment

For more detailed information, readers may refer to the DEN Monograph *Nuclear Fuels*.

### Fresh fuels

Fuels for light (ordinary)-water reactors, whether pressurized-water reactors (PWRs) or boiling-water reactors (BWRs), use fissile material in oxide form: uranium oxide (UOX fuel), or mixed uranium and plutonium oxide (MOX fuel). These oxides, coming in the form of **sintered\*** pellets (with a height, and diameter of about 1 centimeter), are stacked in a metallic cladding tube, this having the purpose of containing radioactive elements, ensuring mechanical support for the pellets, and allowing the removal, to the coolant fluid, of the heat generated by nuclear reactions. The unit as a whole, known as a

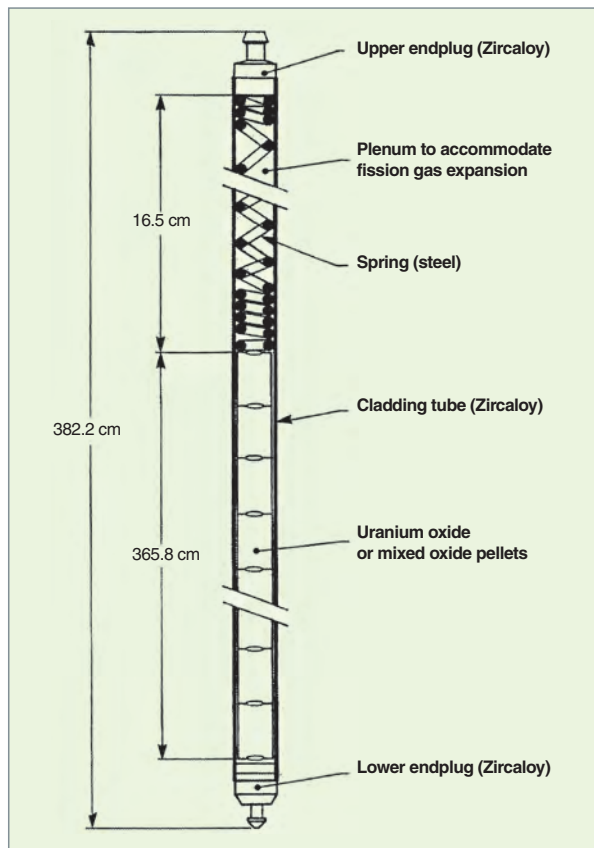

Fig. 18. Schematic of a fuel rod (showing the dimensions for a 900-MW PWR [EDF] rod).

“fuel rod,” has a length of some 4 m, with a diameter of around 1 cm (see Fig. 18). The cladding material is a zirconium alloy, selected for its transparency to neutrons, mechanical properties, and corrosion resistance. The rods are brought together to form a “fuel **assembly\***,” in which they are positioned in a square-mesh array, being held in a structure ensuring, in particular, mechanical support (see Fig. 19). This structure comprises an upper and lower end-fitting (known as the “top nozzle,” and “bottom nozzle”), and guide tubes (serving to accommodate the absorber rods, forming the rod cluster control assemblies), to which are attached the spacer grids, holding the fuel rods in place. The mesh array arrangement allows the circulation of water between the rods, and thus the removal of the heat generated by nuclear reactions. In a PWR, an open structure is used (see Fig. 19), and water may circulate transversely across the assemblies. By contrast, in a BWR reactor, the assembly structure is closed, each rod bundle being enclosed in a casing, or box, precluding any transverse exchange (see Fig. 20).

Fuels for sodium-cooled fast-neutron reactors, or **fast reactors\*** (FRs) come likewise in the form of bundles of pins (fuel rods), these bundles however being of hexagonal section. Each fissile pin, with its stainless steel cladding, holds as a rule a stack of mixed uranium and plutonium oxide pellets (the **fissile\*** zone), sandwiched between two further stacks of uranium dioxide pellets (the **fertile\*** zones). The pin bundle is held in a steel casing, known as a hexagonal tube (see Fig. 21). The gap between pins, required to allow passage for the coolant fluid (sodium), is maintained either by means of spacer grids, or spacer wires (a wire being helically wound around each pin). Alongside these fissile assemblies may be found, positioned at the core periphery (forming a radial blanket), fertile assemblies, of the same design as the fissile assemblies, but holding uranium oxide only.

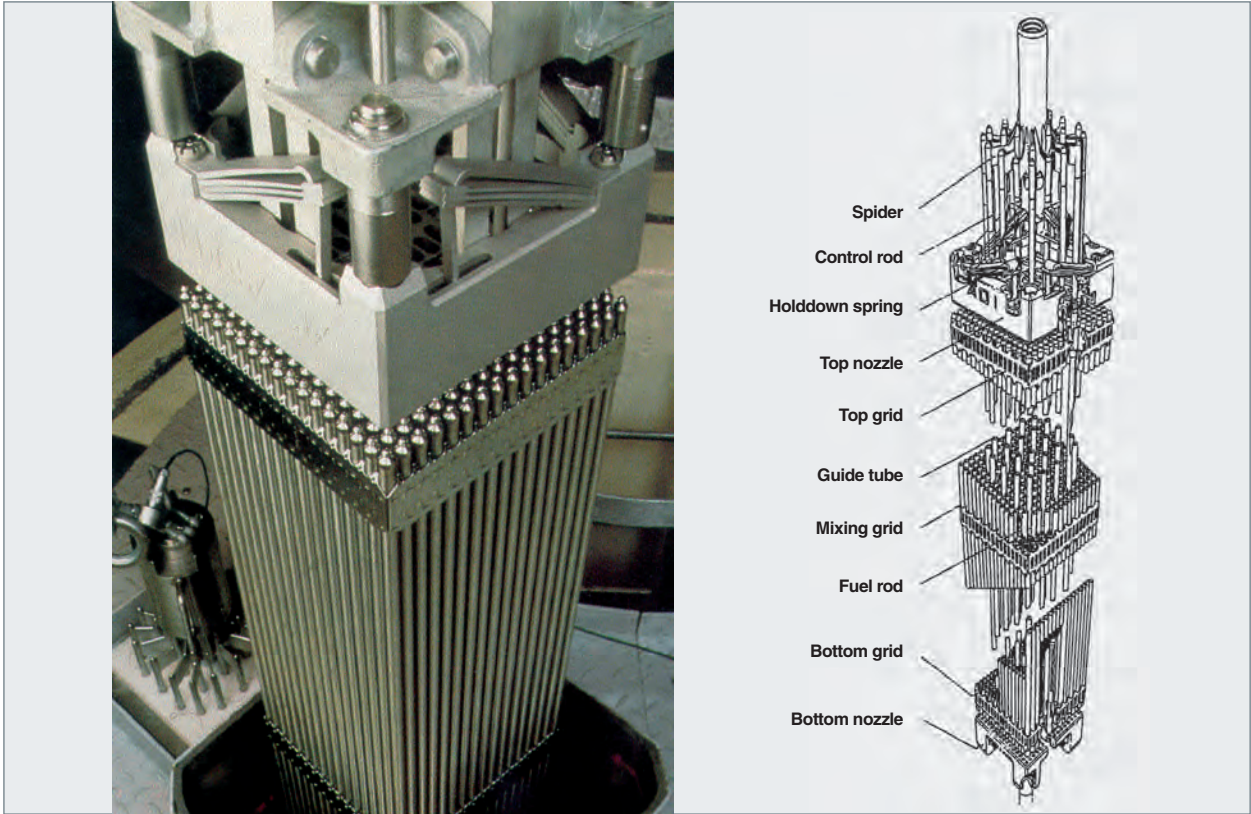

Fig. 19. Schematic (and photograph) of a 17 × 17 fuel assembly and rod cluster control assembly.

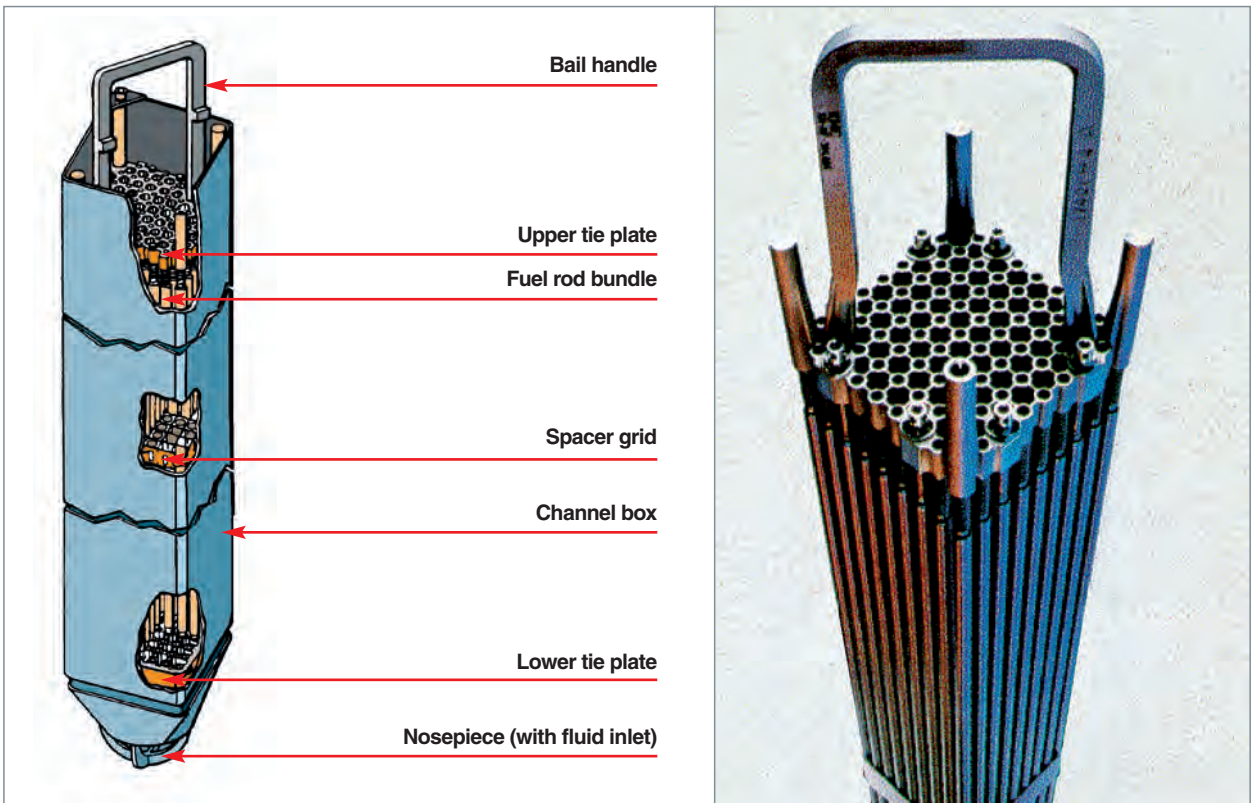

Fig. 20. Schematic (and photograph) of a BWR assembly.

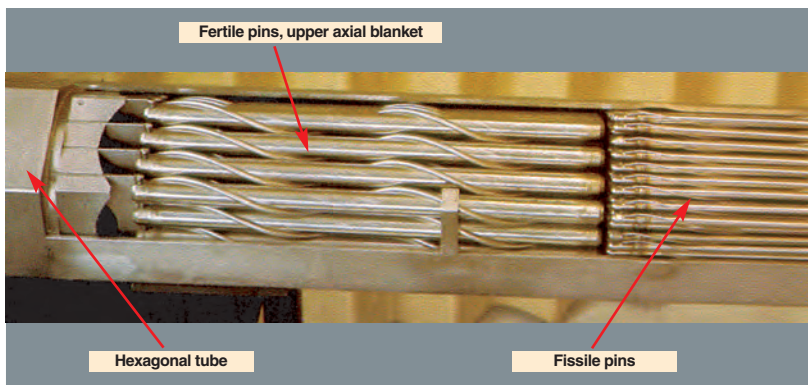

Fig. 21. Phénix fast reactor pins, and assembly.

### Irradiated fuels

During its in-reactor dwell time, the fuel rod is subjected to phenomena of neutronic, thermal, and mechanical nature, altering more or less extensively the physicochemical state of the fuel, and its cladding.

The evolution in chemical composition found to occur in fuels (see Table 4) is due to:

- fission of uranium and plutonium isotopes, depending on the thermal, and fast components in the neutron flux, giving rise to close on 40 elements in the periodic table, from germanium to lanthanides (see Fig. 22), to which should be added tritium, yielded by ternary fissions. By the time the fuel is discharged from the reactor, more than 400 nuclides (whether radioactive or otherwise) are found, of which more than 100 remain, after a few years' cooling time;

- sequences of **neutron captures\***, and heavy nucleus decays, contributing to the formation of other actinides, different from those initially present (uranium and plutonium, for MOX fuels): neptunium, americium, curium (known as **minor actinides\***); and to the alteration of uranium and plutonium isotopy, through consumption of fissile isotopes (U 235, Pu 239...), and generation of new isotopes (U 236, Pu 240, Pu 241...);

- neutron captures occurring in cladding and structural materials, and nonradioactive elements in the fuel (oxygen, impurities), yielding **activation products\***.

The current trend, for power reactors in the light-water reactor line, is to increase fuel specific burnup, this being made possible, for UOX fuels, by uranium **enrichment\*** (to 4.95% U 235), and, for MOX fuels, through increased plutonium content (as a rule, up to around 10%). As a result, at constant electricity outputs, amounts of spent fuels fall correspondingly, the downside being rising amounts of fission products, and minor actinides, and, after equal cooling times, increased specific activity, and decay heat.

Table 4.

**The various families of chemical constituents found in irradiated UOX or MOX fuels**

1																	2		
H																	He		
3	4													5	6	7	8	9	10
Li	Be													B	C	N	O	F	Ne
11	12													13	14	15	16	17	18
Na	Mg													Al	Si	P	S	Cl	A
19	20	21	22	23	24	25	26	27	28	29	30	31	32	33	34	35	36		
K	Ca	Sc	Ti	V	Cr	Mn	Fe	Co	Ni	Cu	Zn	Ga	Ge	As	Se	Br	Kr		
37	38	39	40	41	42	43	44	45	46	47	48	49	50	51	52	53	54		
Rb	Sr	Y	Zr	Nb	Mo	Tc	Ru	Rh	Pd	Ag	Cd	In	Sn	Sb	Te	I	Xe		
55	56	57	58	59	60	61	62	63	64	65	66	67	68	69	70	71			
Cs	Ba	Ln	Hf	Ta	W	Re	Os	Ir	Pt	Au	Hg	Tl	Pb	Bi	Po	At	Rn		
87	88	89	90	91	92	93	94	95	96	97	98	99	100	101	102	103			
Fr	Ra	An	Rf	Db	Sg	Bh	Hs	Mt	Ds	Rg	Uub	Uut	Uuq	Uup	Uuh		Uuo		
Lanthanides		57	58	59	60	61	62	63	64	65	66	67	68	69	70	71			
		La	Ce	Pr	Nd	Pm	Sm	Eu	Gd	Tb	Dy	Ho	Er	Tm	Yb	Lu			
Actinides		89	90	91	92	93	94	95	96	97	98	99	100	101	102	103			
		Ac	Th	Pa	U	Np	Pu	Am	Cm	Bk	Cf	Es	Fm	Md	No	Lr			

<span style="display:inline-block; width:15px; height:10px; background-color: #f08080; border: 1px solid black;"></span> Heavy nuclei (neutron capture)	<span style="display:inline-block; width:15px; height:10px; background-color: #ffff00; border: 1px solid black;"></span> Activation products
<span style="display:inline-block; width:15px; height:10px; background-color: #add8e6; border: 1px solid black;"></span> Fission products	<span style="display:inline-block; width:15px; height:10px; background-color: #90ee90; border: 1px solid black;"></span> Fission and activation products

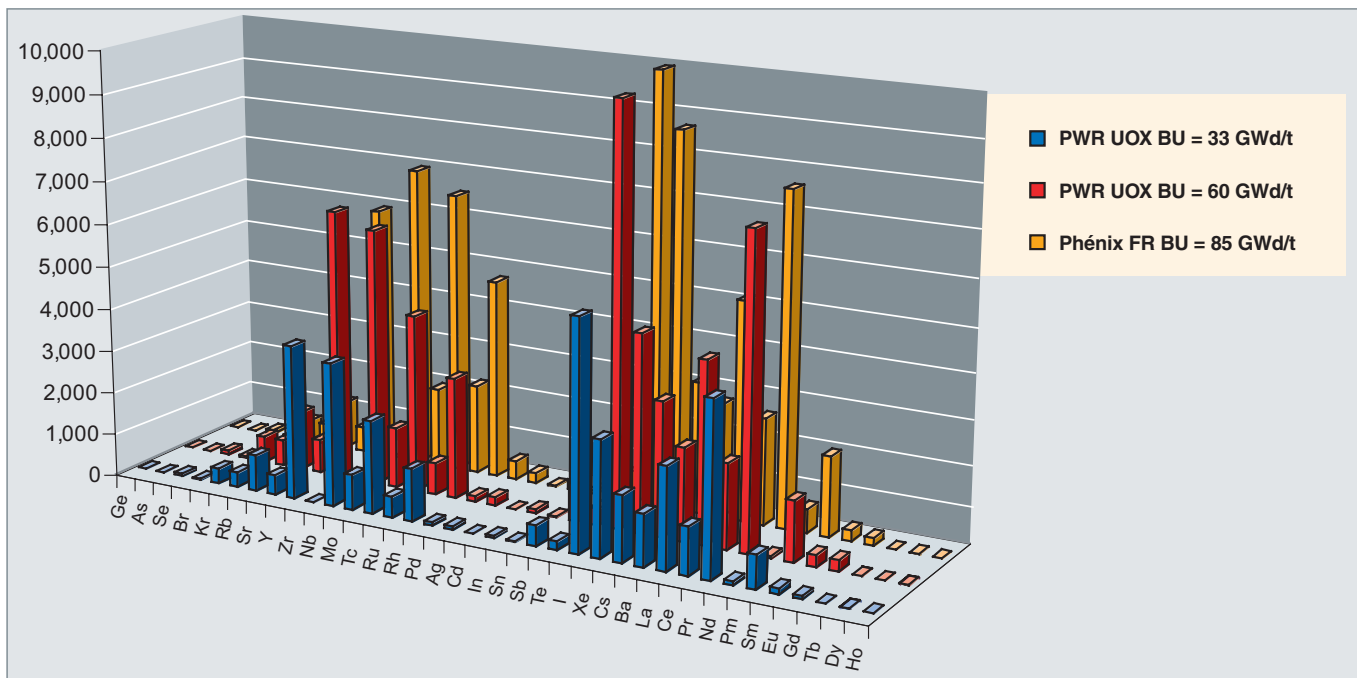

Fig. 22. Evolution, in mass terms (g), of fission product\* yield, for various fuel types.

As regards light-water reactor fuels, the most significant physicochemical alterations to be noted are the following:

- radial and axial cracking in pellets, due to oxide mechanical behavior (these oxides being ceramics), when subjected to the thermal gradient from centerline to pellet rim. Figure 23 shows an instance of radial cracking in a pellet at beginning of life;
- as a part of the fission products, the presence of gaseous products, such as noble gases (Kr, Xe), a fraction of which is released into the rod's free volumes (see Fig. 24);
- at **burnups**\* higher than 45 GWd/t, the disappearance of the initial grain structure, with the formation, at the pellet rim, of a restructured zone, featuring small grains, and a large proportion of closed porosity;
- for UOX fuels, increased plutonium content at the pellet rim (see Fig. 25), concomitant with a major local increase in burn-up;
- damage to the zirconium cladding, due to irradiation, and twin corrosion processes, external corrosion due to the effect of primary circuit water, and internal corrosion under the effect of the fuel itself (in the course of irradiation, an ensemble of phenomena contribute to gradual closing of the pellet-cladding gap, with a contact zone developing, between fuel and cladding).

As regards fuels from the fast reactor line, the very high specific power obtaining under nominal operating conditions (2 kW/cm<sup>3</sup> in Phénix, 1.3 kW/cm<sup>3</sup> in Superphénix, to be compared with values of about 0.2 kW/cm<sup>3</sup> for a PWR) results, aside from pellet fragmentation, in altogether more marked alterations:

- a restructuring of the fuel occurs in its central region, due to migration of as-fabricated porosity to the center, and the heal-

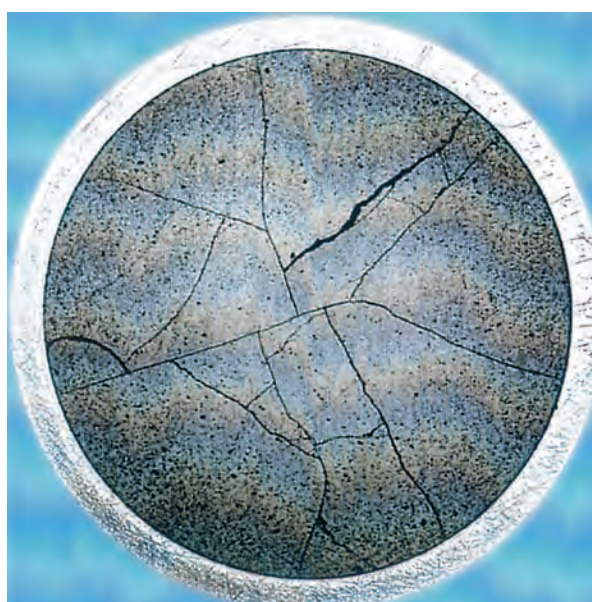

Fig. 23. Cracking in a beginning-of-life PWR UOX fuel pellet.



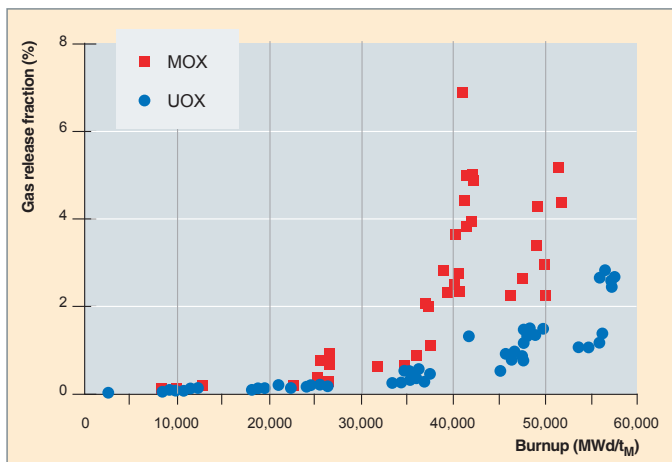

Fig. 24. Evolution, as a function of burnup, of the fission gas release fraction for PWR UOX and MOX fuels.

ing of cracks, with concomitant formation of columnar grains, and (for Phénix-type fuels) a central cavity (see Fig. 26). Such restructuring is accompanied by a considerable redistribution of plutonium concentration, resulting in a significant increase in the central region (see Fig. 27);

- with respect to gaseous fission products (Kr, Xe), the greater part is released into the pin's free volumes. Release fraction may attain 90% of gas yield (see Fig. 28);
- at high burnup (> 8% FIMA), part of the volatile fission products (Cs, I, Te), or of metallic fission products (Mo) migrate, ultimately forming a fuel-cladding bond, between the pellet rim and the stainless steel cladding, with concomitant onset of cladding internal corrosion.

**Aimé VAUDANO,**  
Radiochemistry and Processes Department



Fig. 26. Transverse section of a Phénix pin.

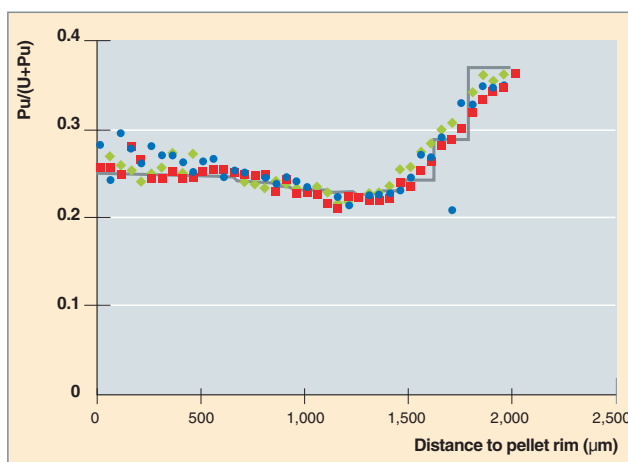

Fig. 27. Radial distribution of plutonium content in a Phénix fast-reactor pellet, irradiated to a burnup of 15.8% FIMA\*.

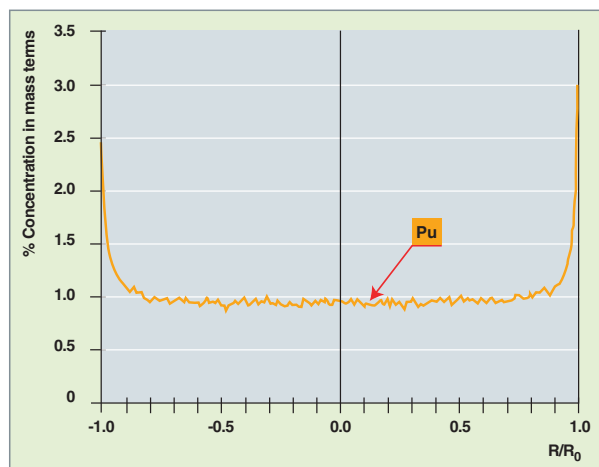

Fig. 25. Radial distribution of plutonium content in a PWR UOX pellet, irradiated over four cycles.

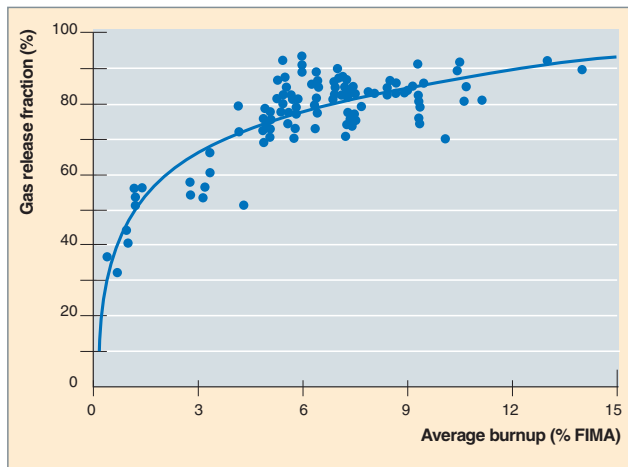

Fig. 28. Evolution, as a function of burnup, of the fission gas release fraction for a Phénix fast-reactor fuel.



# The PUREX treatment process

## technical targets, and specific constraints

### Endproduct specifications

The endproducts of the process, namely uranium and plutonium, must meet certain standards, these being set, for French operations, by the UNIREP (United Reprocessors Gesellschaft) standards.

Uranium, as produced in uranyl nitrate form, must meet, in particular, the following radiochemical specifications:

- sum total of fission product (Zr 95, Nb 95, Ru 103, Ru 106, Cs 137, Ce 144) activities to be less than  $0.18 \cdot 10^5$  Bq/gU;
- sum total of alpha activities (Am, Cm, Np, Pu) to be less than 250 Bq/gU.

Uranium re-enrichment further entails stringent restrictions on chemical impurity levels (less than 3,000 ppm compounds not volatile at 850 °C...).

Plutonium, in turn, must meet the following radiochemical specifications:

- sum total of fission product (Zr 95, Nb 95, Ru 103, Ru 106, Cs 137, Ce 144) activities to be less than  $0.37 \cdot 10^5$  Bq/gPu;
- content of other alpha emitters (apart from Am) to be less than 5,000 ppm.

Produced as they are in dioxide form, plutonium powders must further meet specifications regarding their physical characteristics (homogeneity, particle size, specific surface area), and chemical impurity levels (restricted to 6 000 ppm in the oxide).

Obtaining endproducts meeting such specifications entails achieving very high **decontamination** (or purification) **factors\***. Overall decontamination factors (these in fact depending on the particular fuel, and isotopes, being considered) stand at about  $10^7$  for uranium,  $10^8$  for plutonium, i.e. they rank among the highest purification factors to be found in the chemical industry.

### Restrictions on discharges into the environment

As any nuclear installation, treatment sites are subject to government authorization as regards liquid and gaseous discharges into the environment. A downward trend is observed (see Tables 5a, 5b), with respect to the levels authorized for discharges at the La Hague site, with authorizations including, starting with the order issued in 2003, review clauses as regards reductions in chemical and radiochemical substance impact, in line with the targets set in the OSPAR Convention (the Convention for the Protection of the Marine Environment of the North-East Atlantic, signed in 2002).

Table 5a.

Restriction on liquid discharges authorized at the La Hague site			
Liquid discharges (TBq/year)	1984 order	2003 order	2007 order
Tritium	37,000	18,500	18,500
Iodines	–	2.6	2.6
Carbon-14	–	42	42
Strontium-90	220	12	11
Cesium-137	–	8	8
Ruthenium-106	–	15	15
Cobalt-60	–	1.5	1.4
Cesium-134	–	2	0.5
Other $\beta$ and $\gamma$ emitters	1,700	60	60
$\alpha$ emitters	1.7	0.17	0.14

Table 5b.

Restriction on gaseous discharges authorized at the La Hague site			
Gaseous discharges (TBq/year)	1984 order	2003 order	2007 order
Tritium	2,200	150	150
Iodines	0.11 (halogens)	0.02	0.018
Noble gases, including krypton-85	480,000	470,000	470,000
Carbon-14		28	28
Other $\beta$ and $\gamma$ emitters	0.074	0.001	0.001
$\alpha$ emitters	( $\beta$ and $\gamma$ emitter aerosols)	0.000 01	0.000 01

## Waste conditioning

All waste yielded in the course of treatment operations (process waste), along with waste generated by maintenance, repair, or decommissioning operations (technological waste), must be conditioned in the safest, most stable form possible, for the purposes of storage, and final disposal. It is indeed the constraint regarding the amounts of long-lived radioelements contained in such waste, rather than economic or contractual constraints, that accounts for the high recovery rates, with respect to plutonium and uranium, required for the PUREX process.

## Specific constraints

With respect to the design, and operation of treatment installations, specific constraints must be taken on board, in order to:

- preclude any risks of workforce irradiation (biological protections), contamination (tightness of facilities), and criticality (geometry- or mass-related restrictions), relating to operations involving highly radioactive materials, some of which moreover are fissile;
- preclude any risk of diversion of fissile materials (physical safeguards; strict, ongoing accounting);
- preclude any risk related to **radiolysis\*** phenomena affecting elements being handled (generation of hydrogen...), under the effects of alpha, beta, and gamma radiation, or neutron emission.

**Aimé VAUDANO,**  
Radiochemistry and Processes Department

## The PUREX process: head-end operations

The head end of the process covers all operations making it possible, starting from irradiated fuel, to obtain a clear solution, containing the largest feasible amounts of uranium, and plutonium, exhibiting characteristics allowing the partitioning, and purification of these elements by solvent extraction. Head-end operations include, in particular, shearing fuel claddings, dissolution of nuclear materials, treatment of dissolution off-gases, rinsing of cladding and structural waste, clarification of dissolution solutions, ascertaining what nuclear materials are entering the plant, and adjustments to solutions.

### Fuel decladding

Fuels feature an impervious cladding, acting as containment barrier with respect to the nuclear material held in it, which cladding is not soluble in a nitric acid medium. The first step in the process involves breaking up, or removing this barrier, to allow contact to occur between the fuel, and the nitric leaching solution. This operation is effected almost solely by mechanical means, involving use of shears, hence the name “shearing” for this step (or “chop-leach” for this step and the next).

Chemical dissolution of the cladding (chemical decladding) is another path, which, for such zirconium- or steel-clad fuels, has never been deployed, owing to the corrosion issues arising, due to the reactants involved, and treatment difficulties with regard to the liquid effluents yielded.

### Light-water reactor fuel

In the current plants at La Hague (as indeed in all large-capacity plants involved in light-water reactor fuel treatment), the principle adopted is that of shearing the fuel assembly as a whole, in a block, into segments a few centimeters long (about 3 cm), these then being sent to a dissolver. Shearing is effected by a hydraulically operated blade, set perpendicular to the rod bundle, the latter being firmly held against an anvil by clamps (see the principle schematic in Figure 29). The first, and last cutting actions trim off the top, and bottom nozzles, respectively, these being diverted to a specific end-fitting treatment line.

In smaller-capacity, pilot installations (such as APM, at Marcoule [France]), rods are cut into segments, one at a time

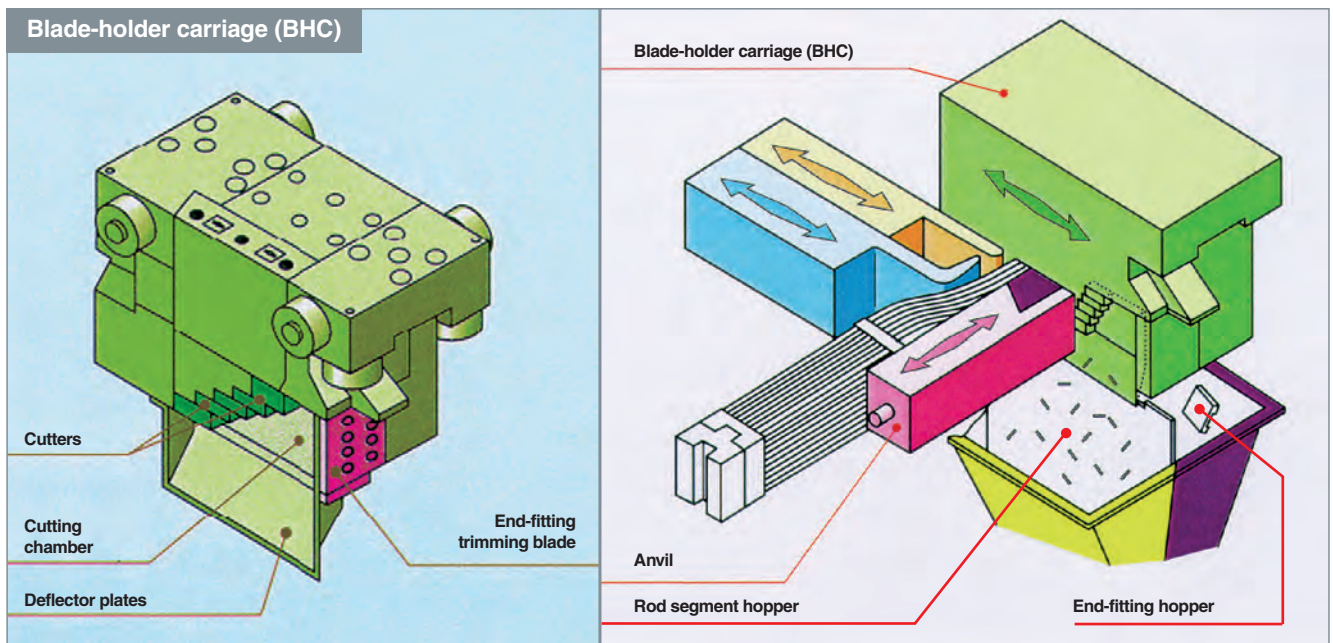

Fig. 29. Operating principle of a La Hague-type industrial shear.



Fig. 30. Photograph of metallic components recovered at the UP3 plant, at La Hague (France), subsequent to shearing, and dissolution of PWR UOX fuel.

as a rule, using a rotary shear (or in a bundle, by means of a guillotine shear), after dismantling the assembly.

For such zirconium-alloy-clad fuels, the body of the shear (along with the connecting lines to the dissolution, and end-fitting treatment lines) is swept with nitrogen, to preclude any risk related to the **pyrophoricity\*** exhibited by the fine zirconium particles yielded by shearing, and to entrain powdered fuel to the dissolver. In industrial conditions, indeed, owing to the shears used, and the evolution undergone by cladding material mechanical properties during irradiation, this operation is more akin to a grinding–shearing action than to a cutting process, yielding large amounts of metallic fragments (Figure 30 shows a photograph of metallic components, sampled at La Hague, subsequent to dissolution), and powdered fuels.

### Fast-reactor fuel

As regards fast-reactor fuels, the presence of a hexagonal tube (HT), of great thickness, means that shearing the assembly as whole, in line with water-reactor fuel practice, may not easily be carried out. Consequently, pins are sheared one by one, or in bundles (for the purposes of Phénix fuel treatment, at the UP2-400 plant, pins were sheared directly in their transport cask, using the shear employed for water-reactor assemblies), after opening up the HT, and dismantling the assembly.

## Fuel dissolution

Dissolution, a key step in the process, has the purpose of bringing into a nitric solution, as completely as feasible, the uranium and plutonium contained in irradiated fuels. Dissolution is effected in a liquid medium, in hot conditions, using nitric acid as reactant.

Uranium dioxide, forming as it does the matrix of the irradiated fuel, rapidly dissolves in hot nitric acid, yielding uranyl nitrate,  $\text{UO}_2(\text{NO}_3)_2$ , with a concomitant release of gaseous nitrogen oxides, the amounts, and composition of these depending on nitric acid and nitrate ion concentration, in accordance with the following reaction:

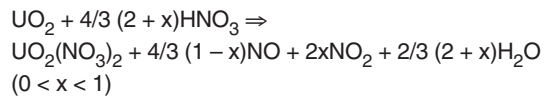

At low acidities (lower than 3 M), the reaction results in NO being preferentially yielded. At higher acidities (higher than 8 M), the favored yield is  $\text{NO}_2$ .

Plutonium dioxide, on the other hand, is practically insoluble in nitric acid, even in concentrated acid. Only solid solutions of mixed plutonium and uranium oxides may be dissolved in nitric acid. For low plutonium oxide contents, ideal solid solutions of uranium and plutonium oxides dissolve in nitric acid, this however involving slower kinetics than is the case for uranium oxide. In the dissolution conditions prevailing as a rule for spent fuel dissolution, as soon as plutonium mass content [Pu/(U + Pu)] reaches about 35%, the insoluble plutonium fraction rises abruptly, reaching 100% once mixed oxide plutonium content reaches 60–70%, as shown in Figure 31. Dissolution of MOX

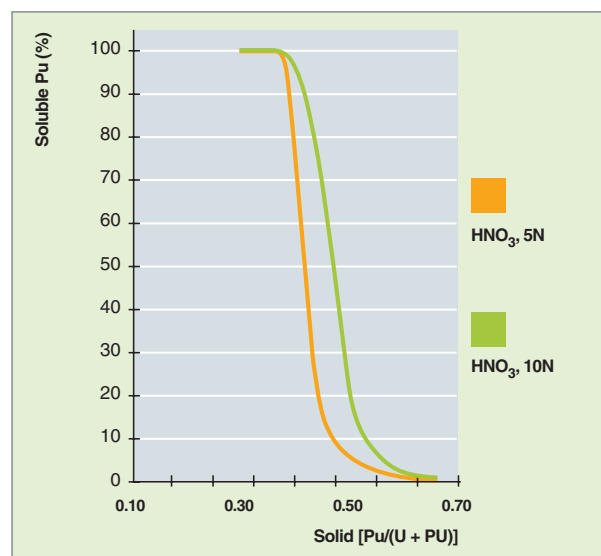

Fig. 31. Solubility of mixed uranium and plutonium oxide, as a function of plutonium content, in nitric acid (5 M, 10 M), at boiling point, over six hours.

fuels (whether FR or PWR fuels) should not raise any such issues, inasmuch as plutonium contents in the mixed oxides remain lower than 30% (as a rule less than 10% in PWR fuels, less than 30% in FR fuels). However, some mixed oxide fabrication methods may result in a degree of heterogeneity, in the form of the presence of islands of higher than average plutonium content. While sintering, and the dwell time in reactor do allow some of these heterogeneities to be removed, the quantitative dissolution of plutonium from mixed U–Pu oxides is the chief consideration that leads to going for “harsher” dissolution conditions, compared with those used for uranium dissolution.

Dissolution conditions are selected according to the kind of fuel involved (UOX, or MOX), its provenance (PWR, or FR), irradiation conditions (burnup), and type of dissolution used (discontinuous, or continuous), to make for the fullest, fastest dissolution feasible of fuel materials, while precluding any solubilization of structural elements (e.g. iron, and chromium, in the case of steel-clad FR fuels).

In industrial operations, dissolution of UOX fuels is carried out in hot conditions (at temperatures higher than 90 °C), at 3–4 N acidity, dissolution time being longer than 2 hours, and target final uranium concentration standing at 200–250 g/l. In such conditions, uranium and plutonium recovery rates remain high (higher than 99.9%), and amounts of dissolution fines remain limited. For MOX fuels from the light-water reactor line, dissolution is effected in hot conditions (at temperatures higher than 90 °C), involving a higher acidity (4–5 N), and longer dissolution time (4–6 hours) than is the case for UOX fuels, target uranium concentration being around 200 g/l. In such conditions, losses of plutonium to dissolution fines remain, as a rule, lower than 0.1%. As regards MOX fuel from the fast reactor (FR) line (irradiated to up to 100 GWd/tiHM), plutonium losses are higher as a rule, standing at about 1%, notwithstanding the “harsher” conditions (dissolution at boiling point, acidity higher than 5 N, operation time longer than 6 hours, uranium concentration 150–200 g/l); such losses are highly dependent on fuel initial plutonium content, oxide fabrication method, and irradiation conditions.

Plutonium oxide may nonetheless be dissolved, through use either of hydrofluoric acid at low concentration in nitric acid, or highly oxidizing ions, such as Ce(IV), Co(III), or Ag(II) [the silver(II) process is used at La Hague for the recycling of non-standard PuO<sub>2</sub> batches]. Implementation of such processes, with irradiated fuels, raises many issues, of corrosion, reactant recycling, and, for the “oxidizing” processes, of oxidizer ion consumption by fission products such as ruthenium (yielding the volatile compound RuO<sub>4</sub>), precluding, for the time being, any move to industrialization.

### Dissolution fines

The term “dissolution fines” covers all small-sized, solid granulates remaining, subsequent to spent fuel dissolution. Such products, entrained as they are with the dissolution solution, arise from a variety of origins:

- metallic inclusions, present in the irradiated fuel (mainly elements from the platinoid family, such as Ru, Rh... whether in association with fuel or other fission products, or otherwise, or in solid solution form), insoluble in a nitric acid medium;
- very finely divided cladding, or structural component fragments (depending on shearing quality);
- insoluble mixed oxide (chiefly when UO<sub>2</sub>–PuO<sub>2</sub> mixed oxides are treated);
- impurities present in the fuel;
- fission products that prove unstable, or sparingly soluble in a nitric acid medium, such as Mo, and Zr, which may precipitate, bearing inclusions of other elements, such as plutonium.

The mass of dissolution fines varies, depending on fuel provenance, and burnup:

- for uranium oxide-based fuel from a light-water reactor, at 33 GWd/t burnup, such fines account for less than 3 kg/tiHM;
- for PWR MOX fuels, this mass is estimated to stand, for a burnup of 33 GWd/t, at some 4–5 kg/tiHM;
- as regards fuel from FRs of the Phénix type, involving a burnup of 100 GWd/t, the amount of fines is larger, reaching about 15 kg/tiHM.

## Dissolver technology

The main function of a dissolver is to keep the fuel (after prior shearing, as regards fuels clad in an insoluble material) immersed, for as long as required for dissolution to occur, in the liquid leaching medium. Once dissolution is complete, the dissolver must allow recovery, on the one hand, of the dissolution solution, and, on the other hand, of insoluble cladding components.

Equipment may be of two types:

- discontinuous, this historically being the earlier type, as a rule used for small treatment capacities;
- continuous, in the more recent types, to allow larger treatment capacities to be achieved.

### Discontinuous (batch)-type dissolvers

The dissolution operation is certainly one for which safety–criticality constraints are hardest to meet (owing to the simultaneous presence of fissile materials in solid form, and in aqueous solution). For this operation to be made “geometrically safe,” the shape that has won general acceptance, for batch dissolvers, is the tube-type thermosiphon (containing a basket in which the fuel is held), combined with a subcritical “slab” tank, holding the acid reserve required for dissolution (see Fig. 32).

As regards dissolvers of this type (a tube, associated to a slab tank), capacities may range:

- from a few tens of liters for the smaller dissolvers, such as the dissolver used in the ATI workshop, at La Hague (France), for which the acid tank was a mere tube (see Fig. 33);
- up to several hundred liters, for the larger dissolvers, such as those used at APM (the last one, with an internal volume of 300 liters, could process batches of several tens of kilograms fuel).

The desire to raise the capacity of such dissolvers entailed increasing the number of dissolution tubes, still associated to a single slab tank (of flat, or annular geometry), as, e.g., for the dissolvers used at the UP2-400 plant, at La Hague, which comprised two tubes, with an annular tank (see Fig. 34).

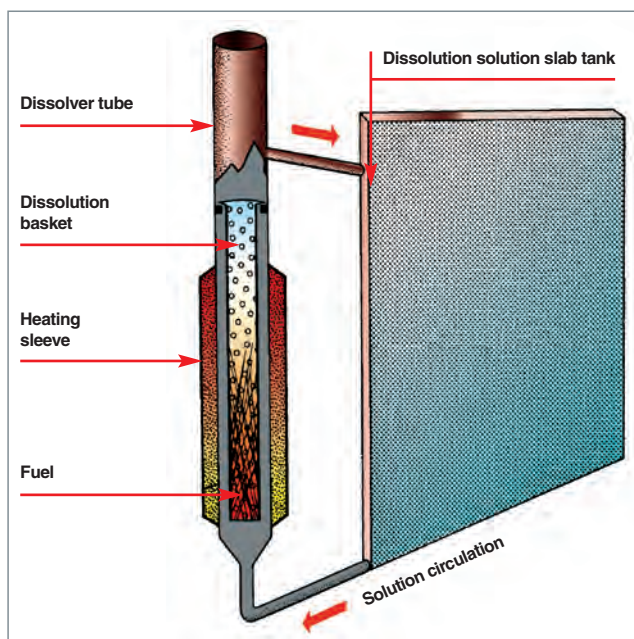

Fig. 32. Principle schematic of a geometrically safe, tube-thermosiphon dissolver.

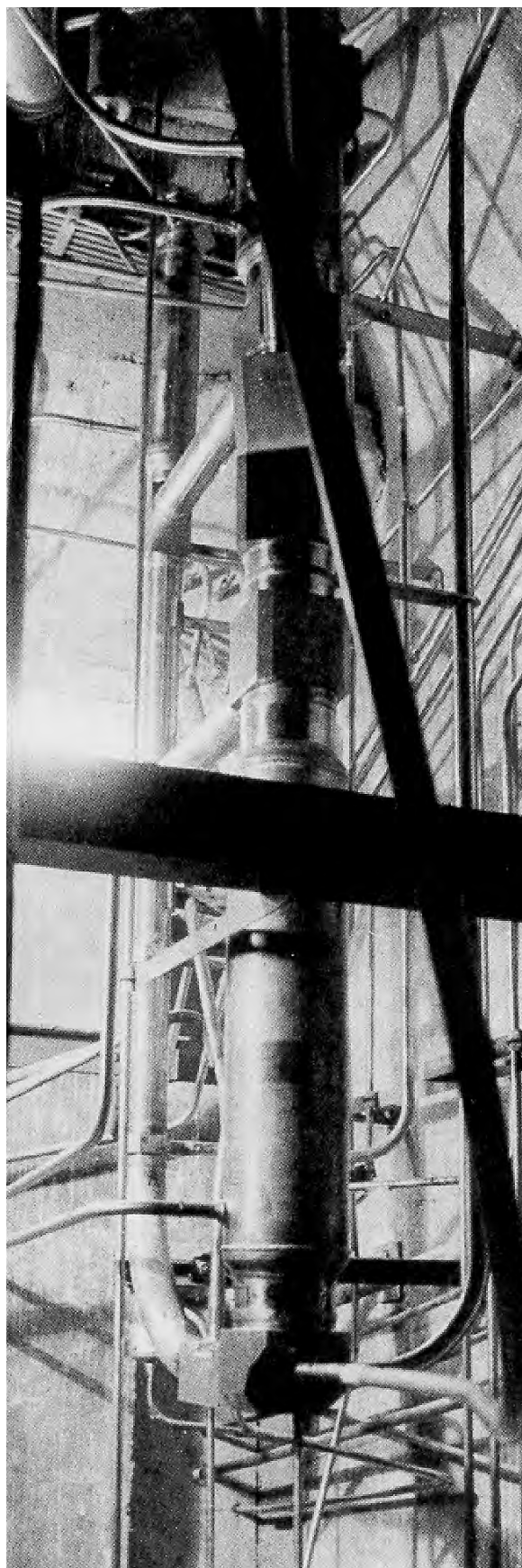

Fig. 33. Dissolver in the ATI workshop, La Hague.



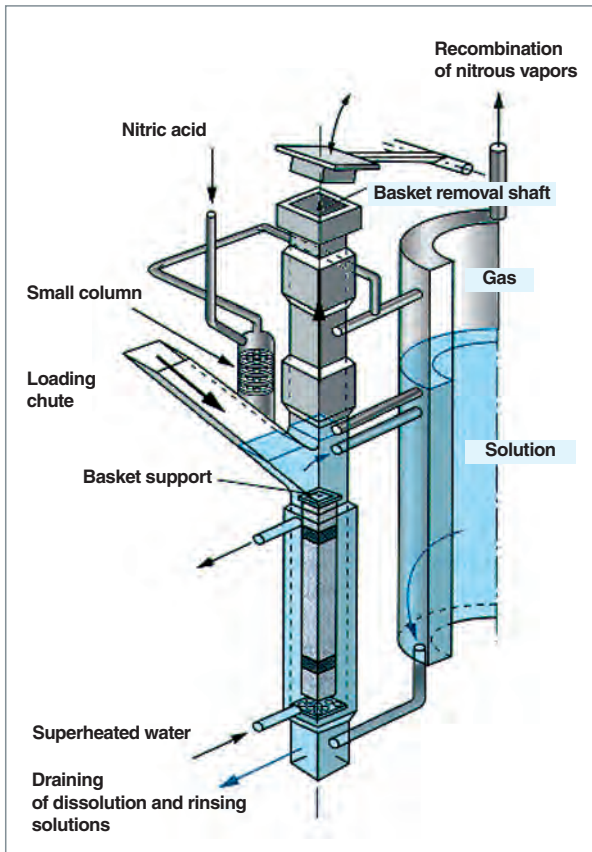

Fig. 34. Schematic of dissolvers used in the UP2-400 plant, at La Hague.

### Continuous-type dissolvers

For this dissolution mode, the chief difficulty has to do with constructing systems that allow the continuous removal of solid fragments (hulls, shearing debris). As early as the 1950s, many concepts were being considered, such as, e.g., horizontal, or vertical vibrating dissolvers fed by helical conveyor; horizontal (or banked) rotary, cylindrical dissolvers; mechanical, moving-basket dissolvers; rotating-wheel dissolvers; or dissolvers involving no moving mechanical parts, such as pulsed step, or pulsed airlift dissolvers.

The only model to have reached industrial service, however, is the rotating-wheel dissolver. In the UP3 and UP2-800 plants, at La Hague, the type being operated, as illustrated by the schematic in Figure 35, is a rotary dissolver, comprising a wheel, or drum, featuring twelve compartments, rotating inside a heated, subcritical slab tank holding the dissolution solution, continuously fed with nitric acid. The unit supporting the drum, by way of roller bearings, is attached to the tank cover. Compartment loading is carried out on a motionless drum, by way of a chute, connected to the shear, fuel segments produced by the shear being gravity fed into a compartment submerged in the solution. The drum is then rotated one-twelfth of a turn. Rotation speed is selected so as to ensure a minimum amount of residence time for fuel segments in the solution. The compartments are discharged in the upper region of the tank, by gravity, by way of a chute connected to a rinser. A pulser, located at the bottom of the tank, and an airlift used to raise

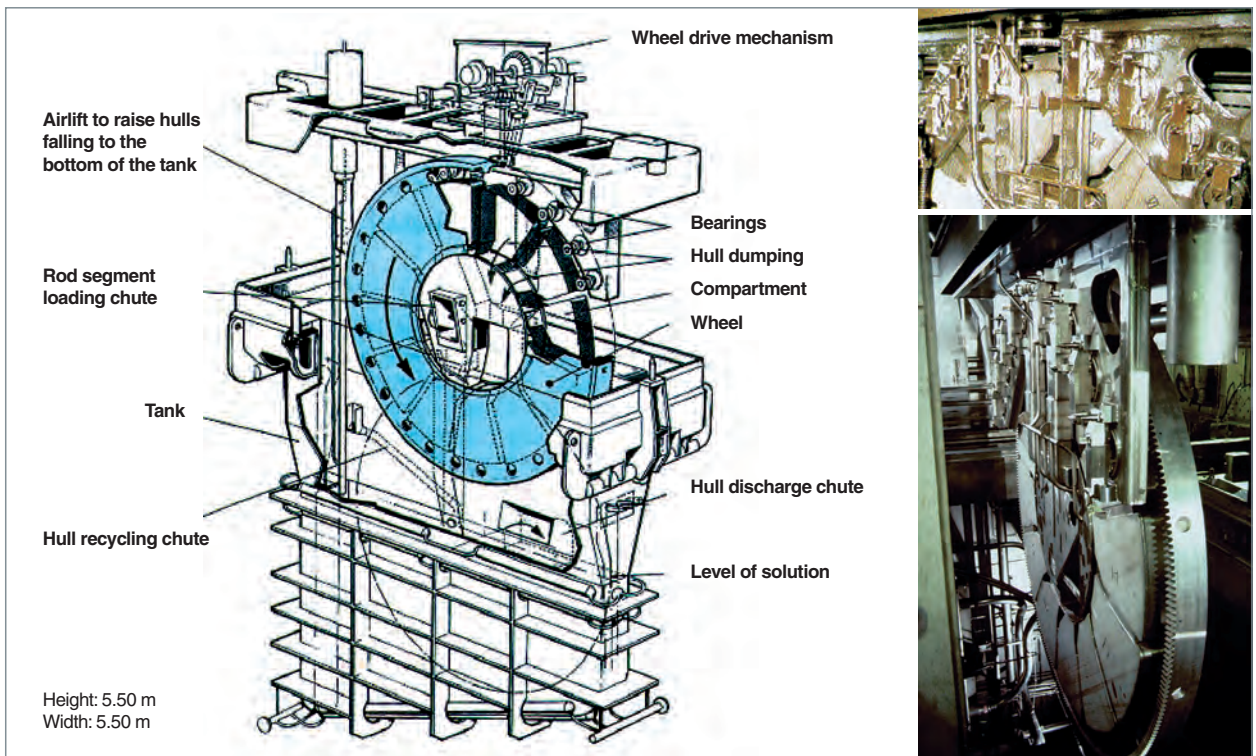

Fig. 35. Schematic, and photographs, of rotating-wheel dissolvers used in the UP3 and UP2-800 plants, at La Hague.

fragments allow removal of debris falling to the bottom of the tank, these being recycled in the compartment being loaded. The cover, and moving parts, made in stainless steel, may be changed. The fixed tank, which cannot be changed, is made of zirconium, a material exhibiting better corrosion resistance in the dissolution conditions of choice.

### The dissolution unit for the La Hague plants

Three dissolution lines, with a nominal unit capacity of 4 t/d, are set up in the current plants at La Hague (UP3, UP2-800). Each line features (see Fig. 36):

- one twin-blade horizontal shear, used to trim off end-fittings, and chop fuel rods, fitted with two hoppers, allowing end-fittings to be diverted to a specific treatment line (end-fitting rinsers);
- one wheel dissolver;
- two end-fitting rinsers, allowing an initial hot nitric acid rinse, followed by a final water rinse;
- one continuous hull rinser, directly derived from design studies for a helical continuous dissolver (DCH: *dissolveur continu hélicoïdal*), designed for the purposes of FR fuel treatment;

- one iodine desorber, used to remove residual iodine from dissolution solutions;
- one off-gas treatment unit, to cater for gases yielded by the dissolver and iodine desorber, featuring, in particular, a nitrous vapor recombination and iodine-trapping unit.

### Dissolution solution stability

One parameter that must be taken into account, with respect to continuous-mode industrial dissolver equipment, is crud formation, due to Mo–Zr deposits forming as a result of instability in mixed zirconium and molybdenum solutions (these being two of the most abundant fission products), in the dissolution conditions that are commonly gone for. Operation of the current dissolvers, and iodine desorbers at the La Hague plants entails that the presence of solid deposits be taken on board. Characterizations, carried out on industrial deposits sampled at La Hague, have shown that these are products largely consisting of fines, and metal chippings from cladding, yielded during fuel shearing, together with zirconium molybdate, acting as a binder (see Fig. 37). Zirconium molybdate, in turn, exhibits the specific property of including other elements, plutonium being one. The most commonly considered formula, for such zirconium molybdate, is the following one:

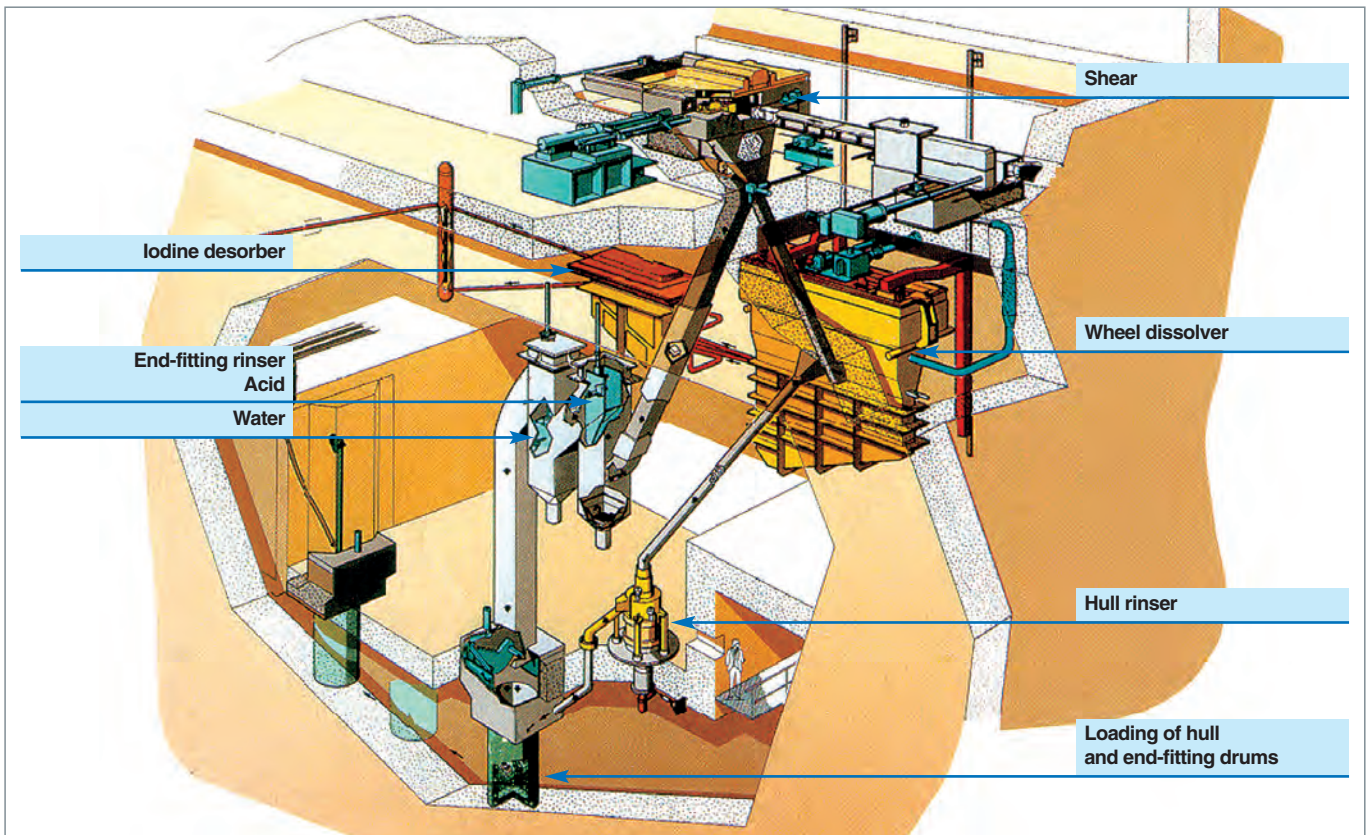
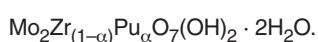

Fig. 36. The main items of equipment in the dissolution lines in the UP3 and UP2-800 plants, at La Hague.



Fig. 37. Mo-Zr deposits, sampled from a dissolver in the UP3 plant, La Hague.



### Understanding, and preventing deposit formation

The stability diagram for mixed molybdenum and zirconium solutions, as determined at CEA, shows that dissolution conditions lie in a region of metastability [1], i.e. a region where particulate deposition, and crystal growth on already-formed deposits, or metal surfaces result in crud deposition in the equipment. Further, by its very design, industrial equipment may locally exacerbate risks of crud formation (increased temperature, or concentration; falloff in acidity), causing some

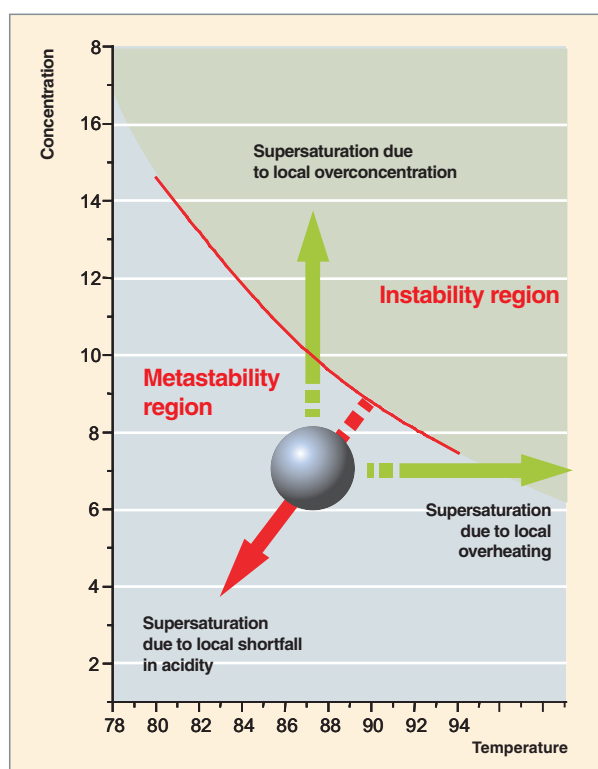

Fig. 38. Stability diagram for Mo-Zr in hot, concentrated nitric media: local evolutions in the operating domain.

areas to go over from metastable to unstable conditions (see Fig. 38).

The evolution of zirconium molybdate crystal growth, as a function of the various operational parameters involved in dissolution, may be summed up, in simplified form, as per Table 6:

- rising temperature results in an exponential increase in growth kinetics;
- increased Mo and Zr concentrations result in heightened growth kinetics; two distinct regions are found: at lower Mo concentrations, up to a supersaturation of 7, the reaction is of order 1.6; on the other hand, at higher Mo concentrations, growth is speeded up, reaction order standing at 3.5;
- increased medium acidity brings down growth kinetics. In the absence of plutonium, the reaction order is rather high, standing at about 6.5;
- presence of an included element, such as plutonium (in oxidation state IV), tends to slow down growth kinetics [2]. This tendency is related to precipitate solubility rising with the plutonium inclusion ratio (as shown by a Lippmann diagram). The Lippmann diagram (see Fig. 39) allows a prediction to be made, on the basis of solution (solutus) composition, of the composition of the solid phase (solidus) that may be formed, and its solubility. As regards Mo-Zr precipitates, phase segregation occurs for higher plutonium contents, which may result in formation of precipitates of the plutonium molybdate type, these, however, remaining more highly soluble than zirconium molybdate.

Table 6.

Evolution of Mo-Zr deposit crystal growth, as a function of the operational parameters involved in dissolution	
Parameter	Growth kinetics
Temperature	↑ "Exponential"
Acidity	↓ "Power 6.5"
Mo, Zr concentration	↑ "Power 1.6-3.5**"
Pu concentration	↑ Related to Pu inclusion ratio

\* Depending on Mo supersaturation

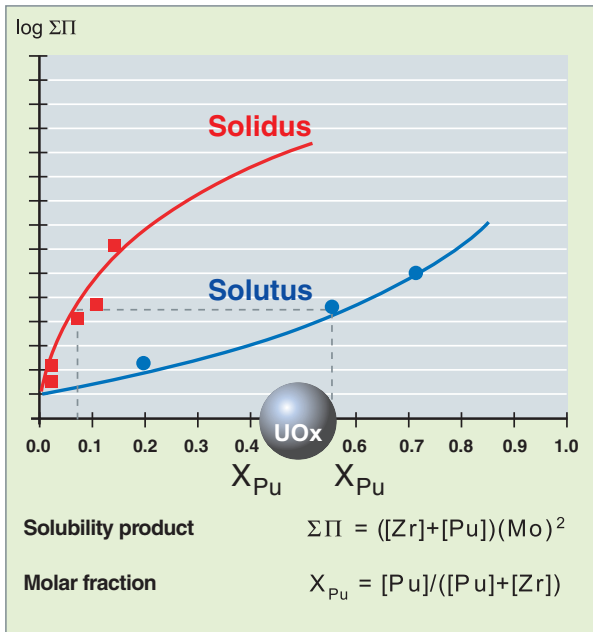

Fig. 39. Lippmann diagram for mixed Zr–Pu molybdate (experimental points: 3 N nitric acid, temperature 87 °C).

This crud deposition phenomenon has led, in existing plants, to the following measures being taken:

- changing, over time, operating conditions – while complying with constraints imposed by safety considerations, and production requirements – the trend being for:
  - lower uranium concentration in dissolution solutions, in order to bring down Mo and Zr concentrations, and consequently slow down growth kinetics;
  - increased nitric acidity, this causing both a downturn in growth kinetics, and in the Pu inclusion ratio; this however must remain compatible with equipment corrosion constraints, and solution specifications for the purposes of downstream operations (extraction cycle);
  - lower temperature, to slow down growth kinetics. A trade-off must however be found, between Mo–Zr precipitate growth kinetics, and the kinetics of fuel dissolution;
- carrying out, on a regular basis, mechanical descaling, and chemical rinsing of the equipment.

## Treatment of dissolution off-gases

Dissolution of irradiated fuels yields gaseous effluents, which may not be discharged directly into the atmosphere. Such effluents include, in particular, nitrogen oxides (NO, NO<sub>2</sub>), yielded by the reaction of nitric acid with the fuel; gaseous, or volatile fission products (krypton, xenon, iodine); carbon-14 (chiefly in CO<sub>2</sub> form); radioactive aerosols. These off-gases are treated in specific units, prior to their discharge through the plant stack. In French plants, treatment processes involve the recombination of nitrogen oxides, to yield back nitric acid, which is then recycled; iodine, and aerosol trapping; and filtering off-gases prior to their discharge.

The main cleanup effort, as regards fission products, is concerned with iodine-129, a long-lived radionuclide (with a radioactive half-life of 1.6·10<sup>7</sup> years). In current practice, in the course of dissolution, the iodine present in irradiated fuel, chiefly in the form of cesium iodide, is mostly desorbed, and entrained with dissolution off-gases. The quantities desorbed directly relate to dissolution mode, and dissolution conditions (temperature, gas/liquid ratio). Residual iodine, remaining in solution, may be carried through all other parts of the plant, being desorbed in the various workshops. In order to avoid a proliferation of iodine traps, fitted to every plant vent, the option gone for was to restrict as far as feasible the quantities of residual iodine in the solution. To that end, a complementary iodine desorption step is carried out on the dissolution solution.

Currently, in the La Hague plants, more than 97% of iodine present in fuel is carried away with dissolution off-gases. Iodine present in such gases is trapped, virtually quantitatively – following nitrous vapor recombination – in the form of sodium iodide, by scrubbing with a sodium hydroxide solution, prior to being discharged into the sea. A second trapping barrier, involving adsorption onto solid substrates (a mineral, silica- or alumina-based substrate, impregnated with silver nitrate) provides complementary off-gas purification. Two further iodine trapping units, using solid substrates (of the same type as those used for dissolution off-gases), ensure immobilization of iodine desorbed in workshops downstream from the dissolution stage. By means of these trapping units, less than 0.5% of the iodine present in fuel is discharged into the atmosphere.

### Bringing forward solutions for iodine immobilization

With respect to iodine trapped by solid substrates, in AgI or AgIO<sub>3</sub> form, an aqueous-path iodine decontamination process has been developed at CEA [3], to allow downgrading of the substrate's classification, and thus allow surface disposal for the substrate, along with discharge of the recovered iodine into the sea (by way of the current outlet, earmarked for iodine-129). The process, involving successive washes of the trapping material, with a reducing sodium salt (sodium ascorbate) solution, an acid solution, and water, was successfully tested



Fig. 40. Iodine-charged (yellow) solid sorbant, sampled from an industrial filter in the UP3 plant, at La Hague, after six years' operation.

on samples (see Fig. 40) taken from industrial filters after nearly six years' service.

The management pathway currently implemented at La Hague involves discharge into the sea. Other management pathways, namely iodine transmutation, or specific conditioning for storage/disposal purposes, are being investigated. These entail enhanced iodine partitioning. Of the various possible iodine (and carbon-14) recovery pathways, one has been the object of particular study [4], this process involving three successive steps (see Fig. 41):

1. Reductive scrubbing of dissolution off-gases with a hydroxylamine nitrate (HAN) solution, in an acidic medium, to effect both iodine-129 recovery, and separation from carbon-14. HAN reacts both with the molecular iodine present in off-gases, reducing it to iodide form, according to reaction (1), while equally reacting, however, according to reaction (2), with nitrous acid, yielded by recombination of nitrous vapors in an acidic medium. The operational conditions selected must be optimized, to promote iodine trapping, and prevent, among other processes, any unwanted reoxidation of iodides to the elemental iodine form, according to reaction (3).



2. A selective iodine desorption step, subsequent to oxidation by hydrogen peroxide ( $\text{H}_2\text{O}_2$ ), according to reaction (4), this further allowing iodine purification with respect to other  $\beta$ ,  $\gamma$  radiocontaminants. This step involves concomitant oxidation of excess HAN by hydrogen peroxide, according to an ensemble of reactions (5, 6, 7), this allowing subsequent channeling of the solution to the fission product concentration and vitrification unit.



3. Conversion of the desorbed iodine to a solid form. One candidate for such immobilization could be lead (in nitrate form, in the presence of a reducing agent, such as hydrazine), to yield, according to reaction (8), lead iodide ( $\text{PbI}_2$ ).

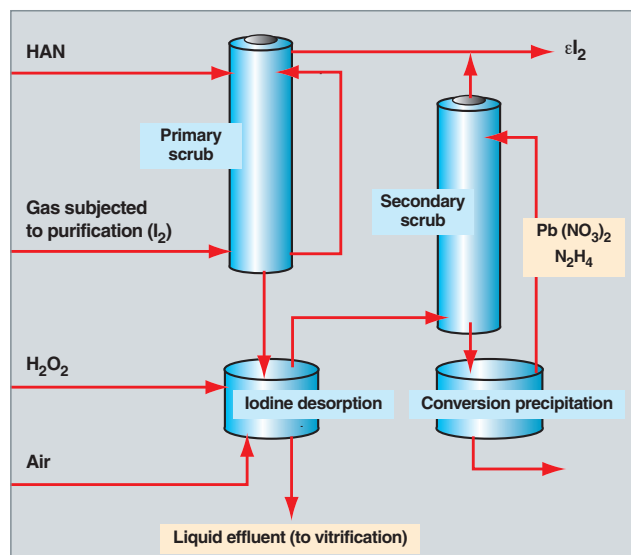

Fig. 41. Flowsheet for a HAN– $\text{H}_2\text{O}_2$  process, that should allow selective iodine recovery, and immobilization.

## Clarification of dissolution solutions

Clarifying the dissolution solutions is an indispensable step, prior to directing them to the downstream operations in the process, to preclude, in particular, any risk of equipment plugging, or solvent degradation related to crud buildup at interfaces. This operation may be carried out by way of a variety of techniques: settling, filtering, centrifugation...

Settling has not been used on an industrial basis, owing to its low efficiency, due to the very small size of some of the dissolution fines.

Filtration, which is an effective technique, was only used in a very limited manner: a sand filter in the UP1 plant, and a pulsed filter (cloth filter leaves, or filter candles, these being flushed out at regular intervals by a reverse flow of part of the clarified solution), at ATI and APM. Use of this technique, as a whole, was limited, owing to filters fouling up, and the difficulty of cleaning them. Other techniques, such as electromagnetic

filtration, tangential filtration... have not, as yet, got past the laboratory stage.

Centrifugation has been the technique most widely used, on an industrial basis, at APM (DPC-140), in the UP2-400 plant (DPC-800), as in the UP3 and UP2-800 plants (DPC-900). The operation, carried out by means of a oscillating centrifuge settler (DPC: *décanteuse pendulaire centrifuge*; the figures specify bowl diameter, in millimeters), involves centrifuging the solution in a cylindrical bowl, the solid pressed against the bowl walls then being given a nitric acid rinse, and subsequently flushed out, to be transferred to a specific tank. The centrifuges currently used in the La Hague plants (DPC-900) have the specific characteristic of featuring a recovery bowl (see Fig. 42), allowing the centrifuged “cake” to be rinsed using a minimum volume of acid, thus limiting dilution of dissolution solutions, prior to directing them to the downstream extraction operations. The clarification efficiency exhibited by such equipment, while limited (about 70%), remains adequate, for the purposes of avoiding issues in the downstream part of the process.

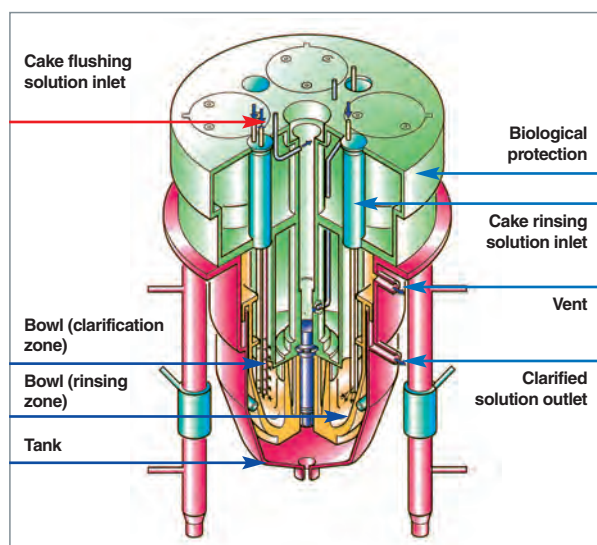

Fig. 42. Schematic of DPC-900 oscillating centrifuge settler.

## ► References

- [1] E. ESBELIN, *Étude de la complexation et de la précipitation du molybdène(VI) par le zirconium(IV) en milieu très acide. Application à la dissolution du combustible nucléaire irradié*, CEA-R-5872; doctoral dissertation, Paris-VI University, September 1999.
- [2] E. BREUNER, *Étude de l'inclusion d'ions métalliques dans les cristaux de molybdates de zirconium et son impact sur les cinétiques de formation*, doctoral dissertation, Paris-VI University, December 2005.
- [3] F. DEVISME, A. JUVENELLE, E. TOURON, "Strategy and current state of research on enhanced iodine separation during spent fuel reprocessing by the PUREX process", *GLOBAL 2001 International Conference on "Back-end of the Fuel Cycle"*, Paris (France), 9–13 September 2001.
- [4] C. CAU dit COUMES, *Potentialités du nitrate d'hydroxylamine et du peroxyde d'hydrogène comme réactifs de traitement des gaz de dissolution du combustible irradié*, doctoral dissertation, Paris-VI University, 30 September 1998.

## ► Bibliography

- Michel BOURGEOIS, "Retraitement du combustible", *Techniques de l'ingénieur*, B-3650.
- M. RAPIN, "Historique des grandes décisions concernant le cycle du combustible nucléaire en France", KTG–SFEN Symposium, *Évolution comparée du cycle du combustible nucléaire en France et en RFA*, Karlsruhe (Germany), 20–21 November 1989.
- Jean SAUTERON, *Les Combustibles nucléaires*, Hermann, Paris, 1965.
- H. BAILLY, D. MÉNESSIER and C. PRUNIER, *The Nuclear Fuel of Pressurized Water Reactors and Fast Neutron Reactors: Design and Behaviour*, Lavoisier Publishing, Paris, 1999.
- P. DEHAUDT, "Le combustible nucléaire et son état physico-chimique à la sortie des réacteurs", CEA Report CEA-R-5929, 2000.

**Aimé VAUDANO,**  
Radiochemistry and Processes Department

# The PUREX process separation and purification operations

## Extraction cycles

Uranium and plutonium **extraction\*** operations, using tri-n-butyl phosphate – widely referred to simply as tributyl phosphate (TBP) – (see Fig. 43), form the core of the PUREX process. In the nitric dissolution solution, elements occur in the following forms (see Table 7):

- uranium occurs in oxidation state +VI, in the form of uranyl ions ( $\text{UO}_2^{2+}$ );
- plutonium is found, essentially, in oxidation state +IV;
- minor actinides – neptunium, americium, curium – occur in a variety of oxidation states: +V, +VI for Np, +III for Am, Cm;
- fission products from the lanthanide family are found in oxidation state +III, alkali metals (Cs, Rb) in oxidation state +I, alkaline-earth metals (Sr, Ba) in oxidation state +II, and zirconium in oxidation state +IV, while molybdenum, and technetium occur in anion form, in oxidation states +VI, +VII respectively.

The challenge is to partition all of this!

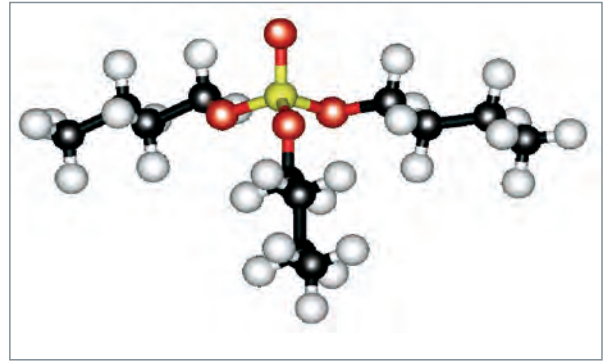

Fig. 43. The tri-n-butyl phosphate (TBP) molecule:  $(\text{C}_4\text{H}_9\text{O})_3\text{PO}$ .

TBP is very sparingly miscible with an aqueous solution. It exhibits – by way of the oxygen atom from its phosphoryl function – the property of drawing certain metal cations, by means of a bond of the ionic type, into a coordination complex.

The extraction mechanism is of the neutral complex solvation type (see Fig. 44):



where M is the extracted metallic element, and  $\text{A}^-$  the coextracted anion, as a rule the nitrate anion, this being abundantly present in the medium.

Table 7.

		Oxydation state					
		I	II	III	IV	V	VI
Major actinides	Uranium						●
	Plutonium				●		●
Minor actinides	Neptunium					●	●
	Americium			●			
	Curium			●			
Fission products	Cesium	●					
	Strontium		●				
	Lanthanides			●			
	Zirconium				●		

Species extractable by TBP  
 Species not extractable by TBP

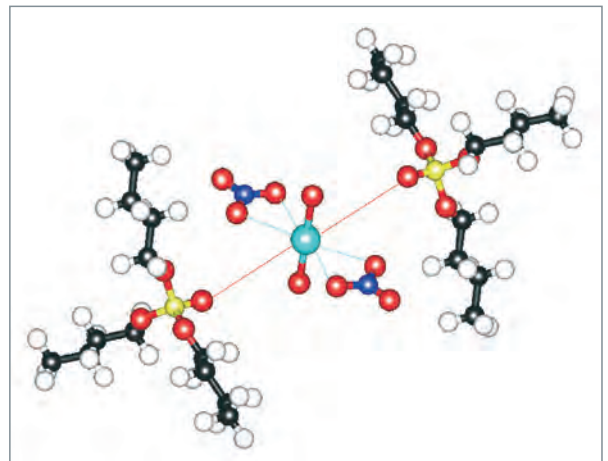

Fig. 44. The complex formed in the extraction by TBP of the uranyl ion ( $\text{UO}_2^{2+}$ ), itself a component in a complex with nitrate anions ( $\text{NO}_3^-$ ).

**Table 8.**  
Recovery yields, and efficiencies for uranium, and plutonium, and decontamination factors for the uranium, and plutonium streams, with respect to  $\beta$ ,  $\gamma$  emitters.

**The decontamination factor**

The decontamination factor provides a measure of the efficiency of a purification, or separation operation. This factor is the ratio of the impurity content (relative to product content) before, and after treatment.

$$DF = \frac{\left( \frac{[\text{Impurity}]}{[\text{Product}]} \right)_{\text{initial}}}{\left( \frac{[\text{Impurity}]}{[\text{Product}]} \right)_{\text{final}}}$$

The purification work effected is all the greater, the higher this ratio is.

1 t irradiated uranium	
U:	955 kg
Pu:	9.7 kg
FPS:	34 kg
MAs:	780 g
MAs ( $\alpha$ ):	120 TBq
FPS ( $\beta$ ):	26 000 TBq

**PUREX**

<b>Glasses</b> FPS: 25 500 TBq	<b>&gt; 9.68 kg Pu</b> (> 99.4%)  $\beta \gamma < 0.4 \text{ GBq}$ $DF \beta \gamma > 6 \cdot 10^7$	<b>&gt; 950 kg U</b> (99.5%)  $\beta \gamma < 0.9 \text{ GBq}$ $DF \beta \gamma > 2 \cdot 10^7$  $\alpha < 0.25 \text{ GBq}$
-----------------------------------	-----------------------------------------------------------------------------------------------------------------	------------------------------------------------------------------------------------------------------------------------------------------------

TBP is found to exhibit, as a rule, much higher affinity for elements in oxidation state +IV, or +VI, than for elements in other oxidation states. Thus, uranyl ions – U(VI) – and plutonium ions, in oxidation state +IV, will undergo significant extraction, whereas extraction of minor actinides (in oxidation states +III, +V), and fission products will prove quite limited, or even negligible for some of these elements.

The treatment workshops in the La Hague (France) complex have the remit of recovering, virtually completely, the residual uranium and plutonium found in spent fuel, to yield uranium and plutonium streams exhibiting a high degree of purification, in particular with regard to fission products. Such high performance requirements are uncommon, since, in conventional metal recovery industries, the aim is to promote recovery efficiency, at the expense of purity, or vice-versa.

This recovery and purification remit is achieved by going through a succession of liquid–liquid extraction, and back-extraction cycles, involving the following operations:

- **extraction\***/scrubbing;
- **back-extraction\*** (stripping) of plutonium, and uranium;
- solvent regeneration.

The first cycle involves an extraction part, where the aim is to coextract to the organic phase the metallic elements of interest, such as uranium, and plutonium, while keeping impurities in the aqueous phase, which is then known as the “extraction raffinate.” This first cycle further involves stripping the metallic elements from the organic solvent to another aqueous phase, forming the cycle’s production stream. The solvent, stripped of the metallic species, is then treated, to remove degradation products formed in the course of the preceding operations. This step corresponds to solvent regeneration, or treatment, the solvent then being reemployed in the cycle. Finally, the uranium and plutonium streams are in turn purified, in further cycles, based on the same principles.

Purification performance is measured in terms of the “**decontamination factor\***,” this being expressed for a solute, relative to an impurity (see Box, above). To achieve the required degree of purity, several extraction cycles may be used.

At the La Hague site, two treatment plants are in operation. The first plant, UP3, commissioned in 1989, with a capacity of 800 t/year, was initially dedicated to the treatment of spent fuels from customers outside France. A second plant, UP2-800, dedicated to spent fuel treatment for the French reactor fleet, came on stream in 1994.

Both plants implement an initial extraction cycle, involving the partitioning of uranium and plutonium streams, and a uranium purification cycle. As regards the plutonium product stream, this goes through two purification cycles in the UP3 plant, whereas only one such cycle is used at the more recent UP2-800 plant.

To achieve a high treatment throughput, all unit operations, as regards liquid–liquid extraction, are carried out in continuous mode. The equipment used for these operations consists in contactors, in which the aqueous, and organic phases flow countercurrently. This allows a cumulative separation effect to be achieved, over each successive stage (see Box on the “extraction factor”).

The various unit tasks may be described, on a step-by-step basis, as follows:



## Liquid-liquid extraction and the "extraction factor"

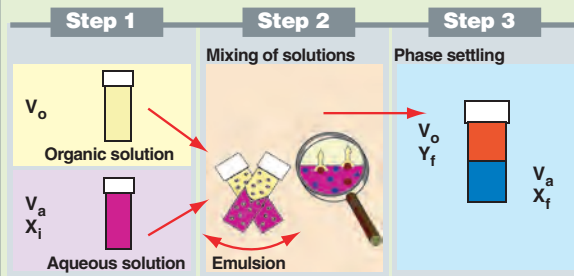

Fig. 46. Principle of liquid-liquid extraction.

### The extraction factor

Let us take an aqueous phase, of volume  $V_a$ , containing a metal cation with initial concentration  $X_i$ ; this is put into contact with a volume  $V_o$  of an organic phase. Once the two phases are thoroughly mixed, cation concentrations at thermodynamic equilibrium, in the aqueous, and organic phases, are noted  $X_f$ ,  $Y_f$ , respectively, being related according to the following equation:

$$Y_f = D \cdot X_f,$$

where  $D$  is the **distribution coefficient\*** for that cation. The material balance, for this operation, may be expressed as follows:

$$V_a \cdot X_i = V_a \cdot X_f + V_o \cdot Y_f.$$

By bringing in the ratio  $X_f/Y_f$ , which is an indicator of the extraction work carried out, expressed as a function of the extraction factor  $E$ :

$$E = D \cdot (V_o/V_a) \\ X_f/Y_f = 1 + E,$$

it may readily be seen that depletion of the aqueous phase is all the greater, the higher the extraction factor.

From this, the Kremser equation may readily be adduced, which, for a continuous countercurrent operation corresponding to  $n$  theoretical stages (thermodynamic equilibrium being achieved in each stage), expresses the ratio  $X_f/X_i$  as a function of the extraction factor, and the number of stages:

$$X_f/X_i = (E^{n+1} - 1)/(E - 1).$$

The decisive operating parameters, for an extraction operation, are thus the chemical conditions, determining as they do the value of the distribution coefficient; and the aqueous to organic phase flow ratio. The extraction factor is selected with a value higher than 1 for operations where the aim is to extract to the solvent phase; lower than 1 when the reverse operation is the aim.

## Extraction/scrubbing

The extraction part in fact involves two unit operations (see Fig. 47), the first of which, designated as the "extraction operation," is strictly dedicated to extraction of uranium and plutonium to the organic phase. The second operation, known as the "scrubbing operation," has the purpose of stripping the fission products or metallic elements occurring as impurities in the organic phase. Indeed, the organic phase's preferential affinity for U(VI), and Pu(IV) – put to advantage as it is to decontaminate the U, or Pu stream with regard to fission products – only operates in the stage in which the aqueous phase is first introduced. The scrubbing operation is thus needed to complete this separation. The aqueous phase yielded by this scrubbing operation contains some uranium, and plutonium, and is naturally sent back to the extraction operation.

For the purposes of uranium and plutonium extraction, operations are carried out at ambient temperature, in a highly acidic medium (3–4 M). The solvent flow should be slightly in excess of that required for the quantity of metal to be extracted, however such surplus must be limited, to restrict extraction of impurities. The operation involves a feed solution bearing a high concentration of U + Pu, this allowing favorable flow ratios to be achieved. As regards the scrubbing operation, the scrubbing solution composition is selected to promote stripping of impurities. The diversity of the elements thus targeted means this often involves a compromise. In effect, experience shows that a highly acidic scrub promotes ruthenium stripping, however this must be restricted, lest too much zirconium be extracted.

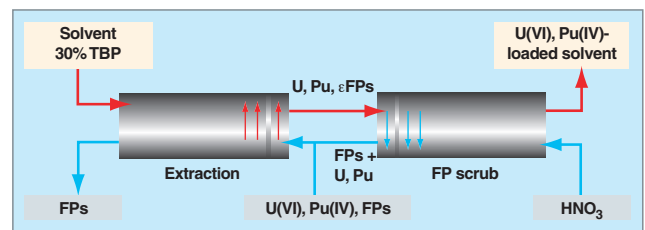

Fig. 47. Extraction-scrubbing operations (each gray rectangle stands for one continuous, countercurrent liquid-liquid extraction operation, requiring a number of stages – as a rule, 8–10 stages).

As a rule, the extraction part involves at least these two, strongly coupled operations (see Fig. 47), the first operation mainly having the purpose of ensuring adequate extraction efficiency, while the second one is aimed at removing unwanted elements.

It may happen that several scrubbing operations are required, to remove species that interfere with the process. With regard to the first cycle, in the plants at La Hague, such is the case of technetium, an element that is, on the one hand, a contami-

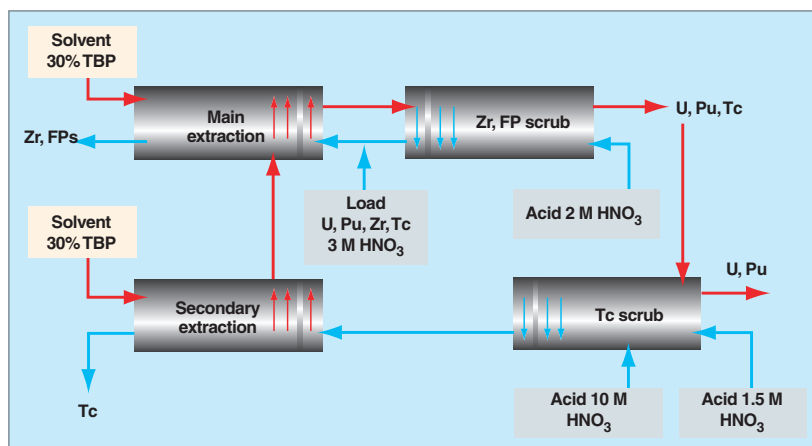

Fig. 48. The flowsheet for technetium scrubbing.

nant of plutonium, and, on the other hand, chiefly stands as a hindrance with respect to selective plutonium stripping.

In effect, the pertechnetate ion,  $TcO_4^-$ , which has the ability to form a mixed complex with zirconium, by substituting for a nitrate anion, is extracted virtually completely to the organic phase. When zirconium is back-extracted in the scrubbing operation, technetium then enters into associations with uranium, and plutonium, thus remaining in the solvent phase. Hence, in order to bring down extracted quantities of this element, the solvent is subjected to a further scrubbing operation, known as “technetium scrubbing,” where it comes into contact with a highly concentrated nitric acid solution. The outgoing aqueous phase, containing the technetium, then undergoes an extraction operation, so-called “complementary scrubbing,” to recover any plutonium, and uranium. The solvent yielded by this complementary extraction operation is reused, to avoid raising solvent flow requirements for the purposes of uranium and plutonium coextraction.

### Plutonium back-extraction

Selective plutonium back-extraction is achieved by reducing plutonium, from the +IV to the +III oxidation state. As may be seen from the very low distribution coefficient involved for Pu(III) (standing at about  $10^{-2}$ ), Pu(III) proves far less extractable by TBP than Pu(IV). Plutonium may thus be stripped to the aqueous phase, while undergoing concentration. This is one of the benefits of this type of operation, since this property makes it possible to do away with evaporative concentration operations, for the plutonium stream thus yielded.

The reducing agent involved is uranium(IV), the reduction reaction proving a fast one, at ambient temperature. On the other hand, plutonium(+III) is an unstable species, liable to reoxidize to plutonium(+IV) in a nitric acid medium, in the presence of nitrous acid. This reaction may rapidly result in complete reoxidation of plutonium, since this works as an autocat-

alytic reaction, inasmuch as it yields more nitrous acid than it consumes. An antinitrous agent, hydrazine nitrate, is thus used, to stabilize the operation, by destroying nitrous acid. The presence of technetium, a catalyst for the oxidation of hydrazinium nitrate, must be taken into account, to determine the quantity of stabilizing agent that should be introduced, if an efficient operation is to be achieved, that proves stable with regard to the risk of plutonium reoxidation.

The plutonium stream yielded by the selective plutonium stripping operation

still contains some uranium, in the conditions implemented for the process. Hence, in like manner to the extraction operation, the stream is treated by means of a scrubbing operation, known as “uranium scrubbing,” to obtain a plutonium stream free of uranium. The organic phase yielded by this operation, containing some uranium and plutonium as it does, is sent back to the stripping operation. The choice of operating conditions, for this function, is the outcome, once again, of a compromise. Plutonium purification must be enhanced, with respect to uranium, however care must also be taken not to return excessive quantities of plutonium, or nitric acid with the solvent, if the plutonium stripping operation is to work effectively (see Fig. 49).

The solvent yielded by the plutonium stripping operation is treated, undergoing a complementary plutonium stripping operation, the so-called “plutonium barrier,” which works on the same principle. The aqueous phase yielded by this operation, possibly containing some plutonium as it does, is sent back to the plutonium stripping operation. This operation makes it possible to ensure that residual plutonium content, in the uranium-loaded solvent, is close to zero. At this point in the process, only uranium is present in the organic phase, the “uranium stripping” operation thus involving uranium back-extraction to the aqueous phase. For that purpose, the solvent phase is put into contact with a low-acidity (0.01 M) aqueous phase, at high temperature (50 °C), with an aqueous/organic phase flow ratio slightly higher than 1.

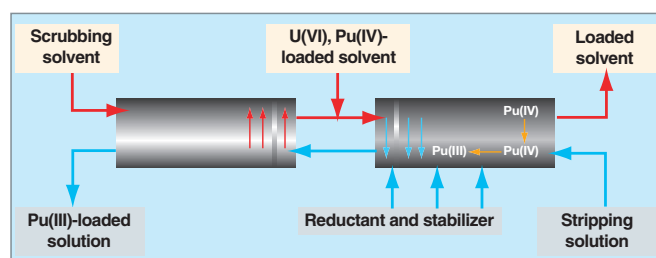

Fig. 49. Selective plutonium stripping and uranium scrubbing operation.

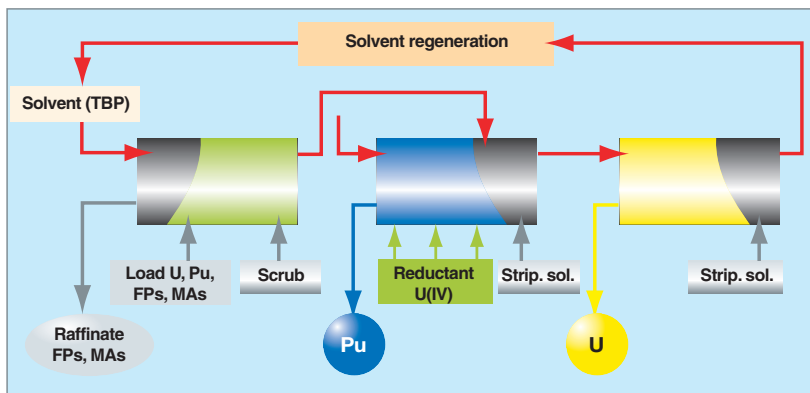

Fig. 50. The first cycle: uranium-plutonium codecontamination, with U-Pu stream partitioning.

The ensemble of operations involved in the first, extraction and partition cycle is set out in Figure 50. At the outcome of these operations, stream decontamination factors of  $10^5$  have already been achieved, for plutonium and uranium. These U and Pu streams do still contain inconvenient impurities, however. In order to complete U and Pu stream decontamination, complementary purification cycles are then carried out, based on the same principles.

Partitioning the uranium, and plutonium streams as early as the first purification cycle is one principle that was adopted at the design stage, for the current treatment plants at the La Hague site. Such partitioning at the earliest opportunity, in the treatment flowsheet, makes it possible to segregate issues related to treatment capacity, for the downstream cycles, from those relating to criticality risk management. The equipment used for the uranium purification cycles comprises large-capacity (4–5 t/d, entailing a solvent flow of close to 3 m<sup>3</sup>/h across the cycle), if simpler units. For the plutonium cycles, the equipment is more complex, as it has to comply with a specific geometry, to preclude criticality risks. The fact that smaller material streams are being treated (a few percent of the uranium stream) calls for equipment of much reduced size. The solvent flow involved in the plutonium cycles stands at some 100 liters per hour.

### Plutonium purification cycles

The function assigned to the plutonium cycle, or cycles (see Fig. 51) is to complete plutonium decontamination, but equally to concentrate the plutonium stream, prior to the conversion step.

As a prior condition for this operation, plutonium must undergo reoxidation, if it is to be extracted, in the extraction part of this cycle. The plutonium stream is thus put into contact with nitrous vapors, in a first packed column, the so-called “oxidation column,” and subsequently with air, in a second column, to remove excess nitrous acid.

Subsequent to this reoxidation step, the plutonium extraction and back-extraction operations both result in increased concentration.

It should be noted that such concentration of the plutonium stream may be enhanced, by providing for the recycling of part of the production stream, at the head end of the cycle.

For stripping purposes, the reductant used is hydroxylammonium nitrate (HAN), this being better suited for plutonium cycles involving higher plutonium concentrations than the initial cycle.

A plutonium barrier, using uranous nitrate, serves to complete plutonium stripping from the solvent, prior to the solvent regeneration operation. Some cycles involve a uranium scrubbing operation.

Concentration of the plutonium stream may be enhanced, by providing for the recycling of part of the production stream, at the head end of the cycle. This complementary purification cycle allows a plutonium decontamination factor of about 750 to be achieved, with respect to Ru, Rh.

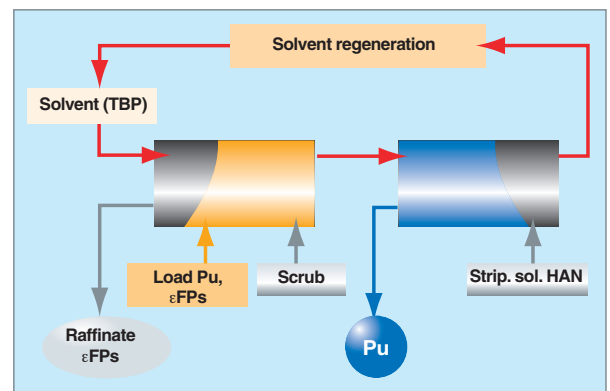

Fig. 51. Plutonium purification cycle.

### Uranium purification cycles

The distribution coefficients for uranium are such that the uranium stream yielded by the stripping operation is at a low concentration. The stream thus undergoes concentration, in evaporators, prior to treatment in the uranium purification cycle (see Fig. 52), to allow the extraction operation to be carried out with more favorable flow ratios.

A fraction of the neptunium coextracted with uranium, and plutonium follows the same path as the uranium stream, throughout the process. In the concentration step, neptunium is oxidized, ending up in oxidation states +V, +VI in the feed solution for this cycle. Hence, to complete uranium purification, hydrazine nitrate is introduced into the extraction step, to

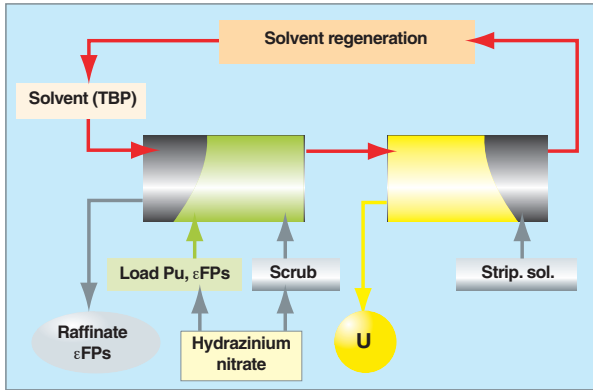

Fig. 52. Uranium purification cycle. This complementary purification cycle allows decontamination factors of 250, and 450 to be achieved, with respect to neptunium, and Ru + Rh, respectively.

reduce Np(VI) to Np(V), which is but very poorly extractable. The uranium stripping operation is similar to that carried out in the first cycle.

### Solvent regeneration

Under the effects of radiolysis, and hydrolysis, the organic phase degrades (see Box on “TBP radiolysis”). When carrying out an extraction cycle, treatments (both physical, and chemical) are provided for, to remove the main degradation products. The degraded solvent is scrubbed with basic solutions, to remove acidic degradation products (see Fig. 53). An initial sodium carbonate scrub is thus carried out, followed by a sodium hydroxide scrub. The residual, if low-level, presence of metal cations accounts for the use, as a first step, of sodium carbonate. The carbonate has the ability to form complexes with stripped metal cations, thus precluding any risk of metal cation precipitation.

A complementary treatment operation, involving evaporation of the solvent, followed by a rectification operation, allows recovery of a purified TBP solution, at 80% titration, on the one hand, and of the diluent, on the other hand. Evaporation makes it possible to remove the heavier degradation products (polymers...), the rectification operation serving to remove the

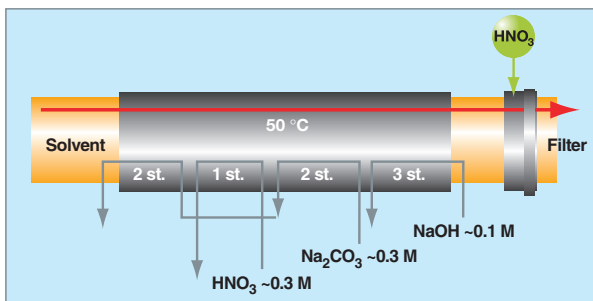

Fig. 53. Solvent treatment.

lighter ones. This operation is carried out separately from the extraction cycles, at regular intervals, on a fraction of the solvent used in the plant.

## Extraction equipment technology

Operating liquid–liquid extraction processes entails setting up an interfacial exchange area sufficiently large to allow a sizeable mass transfer to be achieved, over a given timescale. All the equipment used for the extraction operations involved in the PUREX process thus shares the common feature of forming an emulsion, resulting in a large interfacial area being generated, coalescence of this emulsion allowing phase separation, after contact has occurred.

Three types of liquid–liquid extraction equipment are regularly used, in the area of nuclear fuel treatment: mixer–settlers (MSs), pulsed columns (PCs), and centrifugal extractors (CEs). These are described in the following paragraphs.

### Mixer–settlers

The mixer–settlers in use at the La Hague plants involve a number of units, set up in cascades. The aqueous, and organic phases flow countercurrently. Each unit apparatus, usually referred to as a stage, comprises a cube-shaped mixing chamber, and a rectangular, parallelepiped settler (see Fig. 55). The aqueous, and organic phases are introduced below the mixer, while a turbine, immersed in the mixer, ensures emulsion formation, but equally pumping of both phases from adjacent stages. The mixer is fitted with anti-vortex baffles, allowing improved mixing and pumping efficiencies to be achieved. The emulsion flows into the settler, where phase separation occurs. To restrict any entrainment of one phase in another, plates are positioned inside the settler, their purpose being to prevent the emulsion expanding across the entire settler, and promote drop coalescence.

The interface level in the settler is controlled by a system of weirs, using the difference in density between the phases, and the pressure equilibrium that arises.

A number of improvements have been made, corresponding to specific utilizations, arising in a nuclear environment:

- vacuum weirs, to alter the interface level when variations in phase density are anticipated in transient regimes;
- setups to recycle the aqueous phase, when the organic/aqueous flow ratio is too high, or recycle the organic phase, when that ratio is too low: failing any recycling, indeed, it can be shown that the proportions for each phase, inside the mixer, stand in the same ratio as that for the incoming flows; recycling allows a 50/50 balance to be restored;

## TBP radiolysis

**Radiolysis\*** of the solvent used in the PUREX process results in a mixture involving many compounds, most of these occurring as traces. Indeed, in the presence of ionizing radiation, radicals are yielded by radiolysis of TBP, of the diluent, but equally by radiolysis of water, and of the nitric acid present in the solvent. TBP radiolysis involves the breaking up of C–H bonds, and, to a lesser extent, of C–O, C–C, P–O bonds, the radicals thus yielded having the ability to combine, resulting in the formation of several families of compounds (see Fig. 54). Radiolysis further results in the formation of gaseous products:  $H_2$ ,  $CH_4$ ,  $CO$ ,  $CO_2$ ; of  $C_2$ – $C_4$  hydrocarbon compounds; and nitrogen compounds  $N_2$ ,  $NO$ ,  $N_2O$ ,  $NO_2$ .

In quantitative terms, the majority radiolysis product is dibutyl phosphoric acid (HDBP). For instance, for a dose of 1.14 MGy absorbed by the TBP–3 M  $HNO_3$  system, the molar distribution of degradation products, in the solvent, stands as follows: HDBP 65%,  $H_2$ MBP 3%, modified phosphates (II compounds) 32 %, disphosphates (IV compounds) 1.6%, phosphate–phosphonate (V compound) 0.2%.

Owing to the complexing, or surface-active properties exhibited by certain degradation products, with respect to actinide ions, buildup of such products in the solvent, during the various extraction cycles, may cause a number of phenomena:

- the formation of uranium and plutonium complexes, soluble in the aqueous phase, and not extractable by TBP, which may result in a loss of uranium and plutonium to the aqueous phase;
- a downfall in decontamination performance, for uranium and plutonium, with respect to fission products, chiefly ruthenium, zirconium, cerium, niobium;
- the formation of microemulsions, and “crud,” at the interface of the aqueous and organic phases, liable to hinder mass transfer between the two immiscible phases;
- an alteration of physicochemical properties, including, in particular, increased viscosity.

Radiolytic degradation being an unavoidable phenomenon, a suitable treatment, allowing the removal of unwanted products, must be applied, in continuous fashion, to regenerate the solvent's properties.

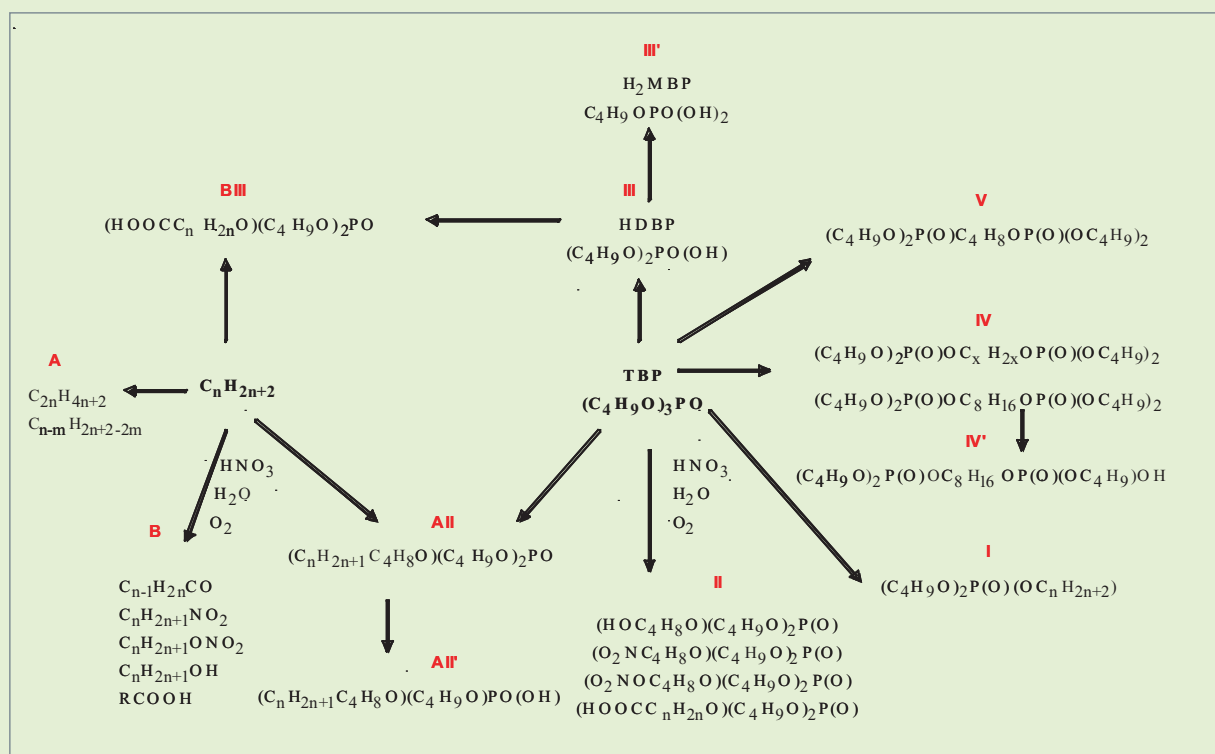

Fig. 54. Radiolytic degradation of tributyl phosphate.

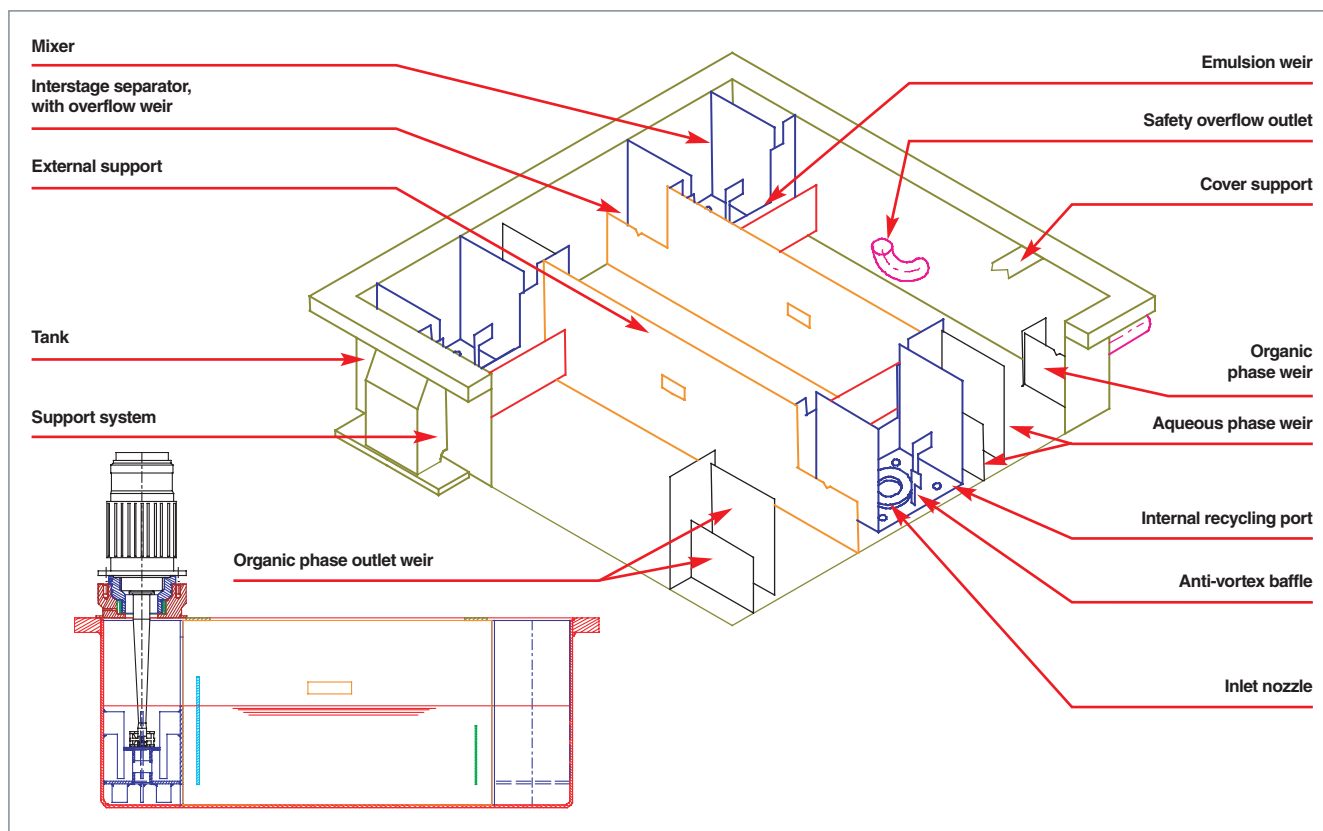

Fig. 55. Schematic of a mixer–settler.

- extra-flat mixer–settlers, to preclude criticality risks;
- impeller maintenance carried out by way of a caisson, to provide biological protection, when activity levels are too high to allow human intervention;
- instrumentation including, in particular, neutron detectors, and a variety of online measurement devices.

The chief advantages afforded by mixer–settlers are their efficiency (standing at close to one theoretical stage for every actual stage), and flexibility. They make it possible, indeed, to operate across a wide range of flow rates, and are easily controlled. Their drawbacks include their size, entailing extended phase residence times, this resulting in solvent degradation due to hydrolysis, and radiolysis; sensitivity to interface crud formation, as found to occur, in particular, during the first extraction cycle; and the requirement for impeller maintenance. Geometrically subcritical mixer–settlers, at the same time, do remain small-capacity units, requiring more careful control.

### Pulsed columns

By contrast to mixer–settlers, pulsed columns are contactors in which distinct, individual separation stages cannot be identified. They stand as continuous contact extraction equipment, one column being equivalent, in efficiency terms, to several theoretical stages forming a countercurrent cascade.

The operating principle of a pulsed column involves circulating the solvent (light phase) from the bottom to the top of a vertical cylinder, countercurrently to the immiscible, aqueous phase (heavy phase) (see Fig. 56). Two operating modes are possible: if the column initially stands full of solvent, the aqueous phase is dispersed, falling in the form of droplets that end up at the base of the apparatus, where they coalesce: this is the organic continuous mode (OCM). Conversely, if the column stands filled with the aqueous phase, the organic phase is dispersed, rising in the form of droplets that coalesce at the top of the equipment: this is the aqueous continuous mode (ACM). In order to generate, and maintain an emulsion inside the column, a reciprocating motion is imparted to the liquid, by way of a pulse leg, connected to the base of the column. This motion is superimposed onto the phase flows, setting up turbulence around obstacles positioned inside the column. As a rule taking the form of perforated disks, these are commonly referred to under the general term “packing.”

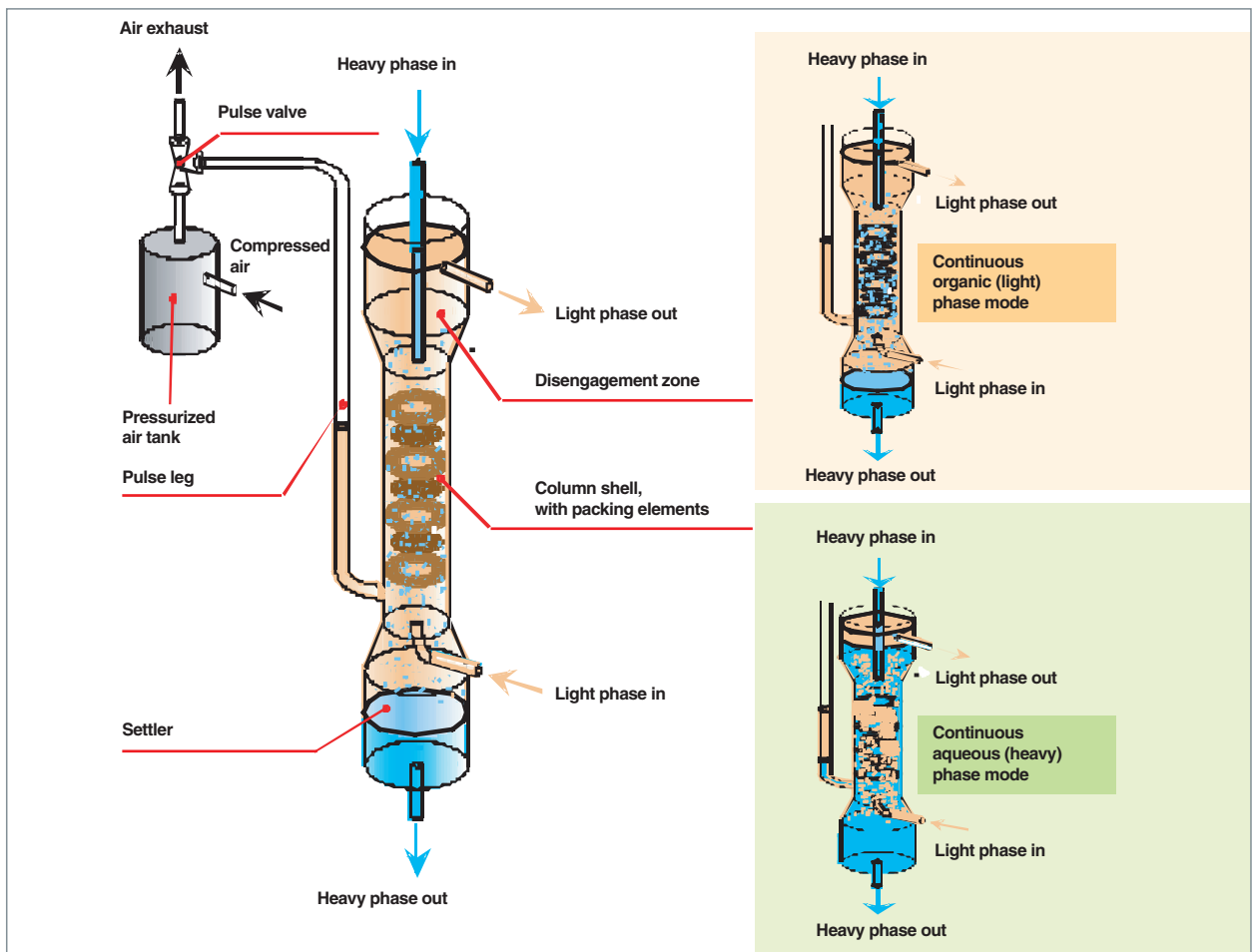

Fig. 56. Principle schematic of a pulsed column.

Specific developments have been brought forward at CEA, to take on board the very stringent constraints involved in nuclear fuel treatment: in particular, column operation must be guaranteed over the plant's lifetime, the ability to carry out interventions on this type of equipment being severely restricted.

Of the main options taken up, in this respect, the following may be noted:

- going for an annular geometry, for first-cycle columns, on criticality grounds. Suitable packing had to be developed, with regard to various criteria: tray type, influence of surface wettability, tray separation, and its influence on pressure drop, axial mixing...;
- opting for a pneumatic pulsers makes it possible to preclude any contact between radioactive solutions, and the pulse valve;
- selecting a pulse pressure that is lower than the column's minimum operating hydrostatic pressure ensures that air from the pulsers may not enter the column, should the pulse valve remain blocked in the pressurization position;

- transfer of liquids between columns (typically, the columns at the La Hague workshops involve a shell height of 8 meters) is effected by gravity, and by means of airlifts (see Fig. 57);
- using bubble tubes to carry out pressure measurements at various elevations inside the column, to determine the interface level, phase densities, and column weight, this providing an indication, to some extent, of average dispersed-phase holdup within the column. Use of bubble probes makes it possible to avoid any contact between pressure sensors and radioactive liquids, thus allowing maintenance of electronic equipment, owing to its relocation to zones where interventions are more easily carried out.

Other, more specific, investigations have been carried out, with regard to cases where extraction operations involve the presence either of gases yielded *in situ* by chemical reactions (plutonium stripping) – leading to a recommendation that systems be put in place, to restrict aqueous phase entrainment through to the solvent outlet – or the presence of materials in suspension, possibly calling for flushing devices being installed at the interface level.

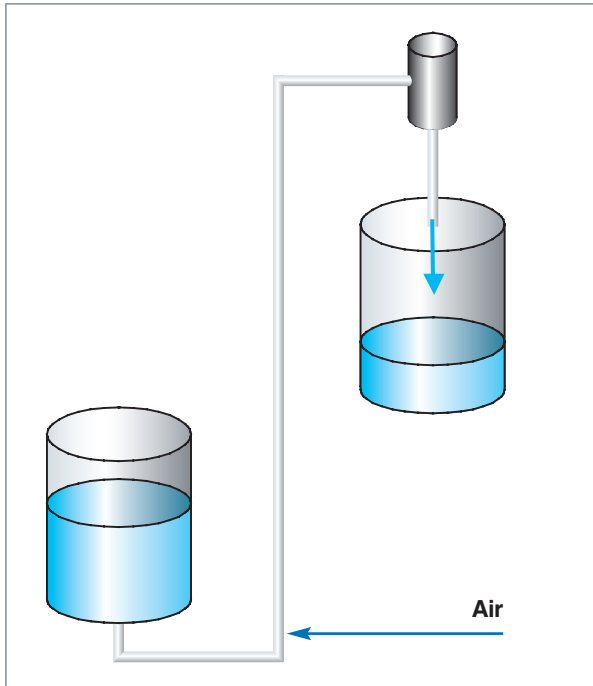

Fig. 57. Principle schematic of an airlift. This device allows a liquid to be circulated by injecting air into the lower part of a vertical pipe. The lower density of the mixture thus generated results in a higher fluid column arising than with no air, thus allowing gravity flow to occur. The liquid flow rate obtained depends on injected air flow rate.

The chief advantages afforded by pulsed columns are as follows:

- no maintenance operations in radioactive areas;
- ease of construction, as regards subcritical-geometry columns, even for high-capacity models (annular columns);
- the ability to limit organic phase residence time, by switching to the aqueous continuous mode (ACM);
- low sensitivity to crud and suspended solid materials.

Pulsed columns do however involve a number of drawbacks:

- their height, which may have an incidence on workshop civil engineering;
- limited flexibility, in terms of capacity: a column that has been dimensioned for a given throughput will undergo a downfall in extraction performance, if operated at half the throughput;
- the requirement to flush out the materials being processed, if a shutdown of a few hours is called. By contrast, mixer-settler cascades can be shut down as they stand, and then started up again (provided the process being carried out does not involve a step controlled by chemical reaction kinetics);
- extended solvent residence time, when operating in the organic continuous mode.

### Centrifugal extractors

While pulsed columns were developed with the aim of ensuring availability of a simple, robust piece of equipment, for which maintenance operations are relocated to peripheral areas, the multistage centrifugal extractors used in some fuel treatment workshops (see Fig. 58) are of much more complex mechanical design, requiring careful maintenance, this involving the use of intervention devices fitted with suitable radiological protections.

The principle schematic for a centrifugal extractor stage is set out in Figure 59. The extractor comprises a bowl, rotating about a vertical axis. The two phases circulate countercurrently in the annular, outer region, this comprising, for each stage:

- a mixing (agitation) chamber, in which a stationary disk, integral with the machine's central shaft, is immersed;
- a settling chamber, where centrifugal acceleration is used to effect phase separation.

Weirs and channels allow the phases to flow countercurrently.

The chief advantage afforded by centrifugal extractors is their compactness. Residence time is a matter of seconds, this resulting in a marked diminution in solvent radiolysis, a much



Fig. 58. Cutaway view of a Robatel centrifugal extractor, as used at the La Hague plant.



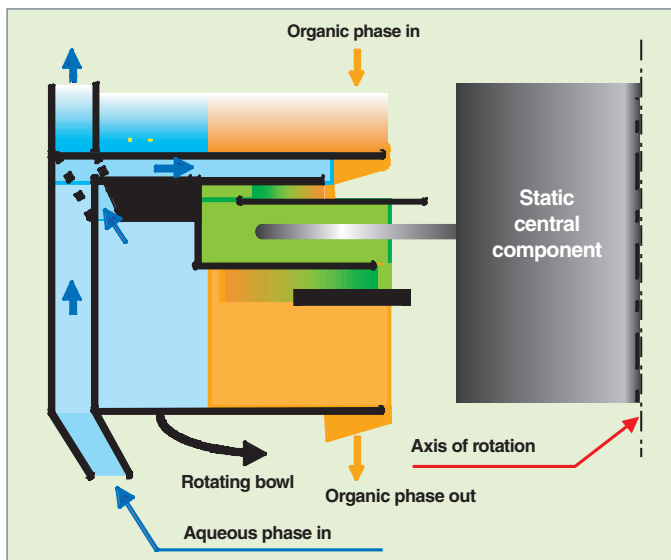

Fig. 59. Principle schematic of a centrifugal extractor (detailed view of one stage).

reduced material inventory, and very fast achievement of chemical equilibrium. On the other hand, this type of equipment proves unable to deal with solids, which cause plugging of the circulation channels, in the outer region. It is not suitable for extraction operations involving slow kinetics. Equipment heating up must be monitored, owing to the agitation power imparted to the fluids.

### Industrial operations at La Hague

All three types of extraction equipment are in use in the UP-3 and UP2-800 plants. Table 9, below, details the design options selected.

Table 9.

Extraction equipment operated at the La Hague plants.		
Plant	Workshop	Equipment used
UP3/UP2-800	First-cycle extraction	Annular pulsed columns
UP3	First-cycle uranium–plutonium partitioning	Mixer–settler cascades
UP2-800	First-cycle uranium–plutonium partitioning	Annular pulsed columns
UP3/UP2-800	First-cycle plutonium stripping	Mixer–settler cascades
UP3/UP2-800	Uranium purification	Mixer–settler cascades
UP3	Plutonium purification	Pulsed columns
UP2-800	Plutonium purification	Centrifugal extractors
UP3/UP2-800	Solvent regeneration	Mixer–settler cascades

### Hydrodynamic modeling of pulsed columns

Even though workshop operations, at La Hague, have demonstrated the satisfactory performance of pulsed columns set up there, dimensioning optimization for such equipment, for the purposes of future plants, calls for the modeling of column operation, to arrive at improved quantitative evaluations of the influence of the geometric, and operating parameters determining equipment efficiency.

Modeling continuous-phase flow, assuming it is the only phase present in the column (single-phase case), thus allowed, by resolving the fluid mechanics equations involved (CAST3M code, developed at CEA), a description to be arrived at, of the axial mixing induced by phase agitation inside the column: on the basis of the evolution of the computed velocity field, the dispersion of a colored tracer may be simulated (see Fig. 60), from which the axial mixing coefficient may be derived. The values thus arrived at are consistent with those determined experimentally, using colorimetric tracing.

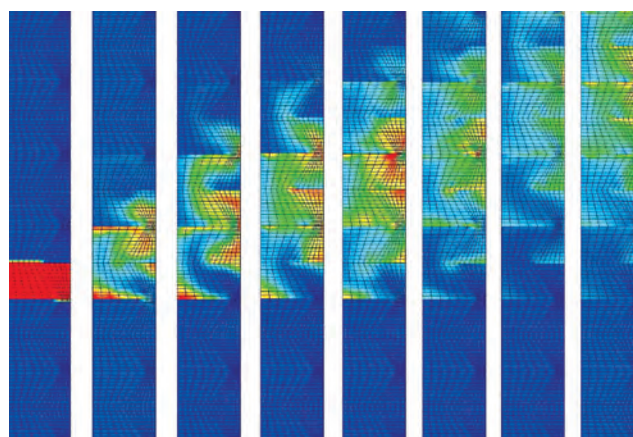

Fig. 60. Simulation of tracer dispersion inside a pulsed column, using the CAST3M software, developed at CEA.

## Modeling the PUREX process. The PAREX code

The PUREX process should allow high performance to be achieved, both with respect to recovery efficiency, as regards the products intended for recycling, and their purification, while ensuring the safety and long-term viability of these operations. Indeed, the chemical engineering unit operations, in particular the liquid–liquid extraction operations, involved in this process have to meet a multiplicity of peculiarly stringent constraints.

At the same time, the choice of operating parameters, for the various unit operations, is often the outcome of a tradeoff, between the performance required for the process, and operating robustness, in particular with regard to the risks of fissile material buildup, or losses. While uranium and plutonium are the elements of interest, the recovery of which is being sought, the behavior of minority species, such as minor actinides, or certain fission products, must equally be taken into account.

To enable true process optimization to be achieved, bearing in mind the exhaustive nature of the investigation required, with respect to some essential aspects of these processes – such as is the case for criticality risk analysis – a major effort was launched, as early as the 1970s, in the area of solvent extraction operation modeling, this carrying through from then on, especially in the period when the La Hague plants were being built.

The PAREX code, which has the capability to simulate the extraction operations used in the PUREX process, was gradually built up, to meet requirements related to construction of the new extraction workshops, whether it be for flowsheet design for the various workshops, and related operational analyses, or for operating aids, as the workshops came on stream. A deliberately modeling-based approach was thus implemented, for the purposes of process development.

### The modeling approach

**Phenomenological analysis** allows a survey to be made of the elementary processes (chemical species, phase-transfer reactions, oxidation–reduction reactions, chemical reactor hydrodynamics, thermal processes...) that must be taken into account, with regard to the results desired. This step allows an initial hierarchy to be set up, between processes that are of importance, for the purposes of modeling operation behavior, and those deemed to be secondary, which may thus be passed over, in an initial approach. Further, this step allows an assessment to be made, of the level of interaction set up between elementary processes – which, combined with the process hierarchy, assists in determining the level of sophistication, and precision required for the following step, of process modeling.

The **elementary process modeling** step has the purpose, ultimately, of suggesting mathematical laws, allowing a repre-

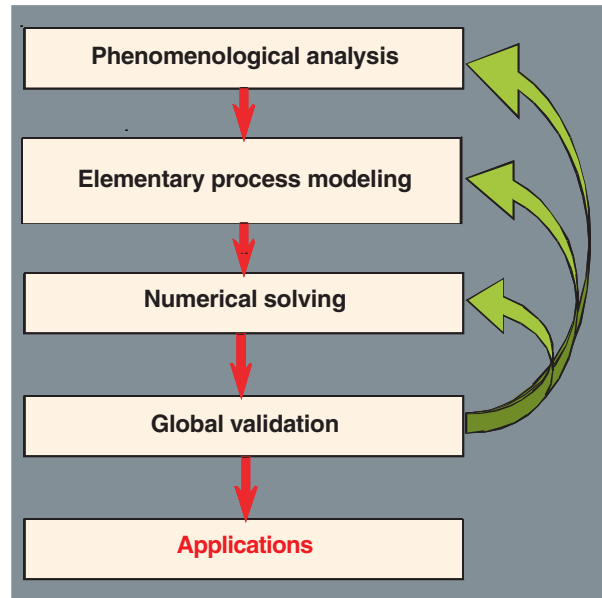

Fig. 61. The steps in the modeling approach for the PUREX process.

sentation of these processes, and of ascertaining the constants involved in these laws.

The analysis of discrepancies arising between computed results, and experimental findings, as part of the **global validation** step for the model, makes it possible to detect either a need for processes to be taken into account, that had been deemed negligible in the initial approach; or for an adjustment in the laws, and/or the constants used for the elementary processes (refining elementary process representation).

As the selective plutonium stripping operation (see the section on “Extraction cycles”) is the most complex one, the phenomenological analysis on which the PAREX code relies for this was carried out by taking on board the characteristics of the operation.

Thus, the chief physicochemical processes taken into account in the PAREX code are:

- *species distribution*: solvent extraction thermodynamic equilibrium;
- *interfacial mass-transfer kinetics*: taking on board the fact that thermodynamic equilibrium, for the extraction process, is not achieved instantly;
- *oxidation–reduction reaction kinetics*;
- *specific liquid–liquid contactor characteristics*: chemical engineering modeling of extractors, this making it possible to take into account the incidence of hydrodynamic processes, inside extractors, on their efficiency;
- *thermal processes*: account is taken of chemical reaction enthalpies, heat exchanges with the surrounding atmosphere, along with heat sources of mechanical origin, with regard, in particular, to centrifugal extractors.

The phenomenological analysis further made it possible to show, on the one hand, that all of these processes are coupled, and, on the other hand, that particular attention must be paid, specifically, to the modeling of species distribution, and to certain redox kinetics, as regards reductive plutonium stripping operations. By way of example, with respect to distribution, since liquid–liquid extraction operations are carried out by means of successive equilibria (theoretical stages), error propagation is of the exponential type. As regards the PUREX process, as implemented at La Hague, where each operation requires some 8 theoretical stages, a systematic error of 10% in the computation of one distribution coefficient will result in an error by a factor 2 on the exit concentration for these stages.

### Modeling species distribution

As regards the U–Pu partitioning operation, in the PUREX process, for instance – one of the most complex operations in the PUREX process – more than 10 chemical species must be taken into account: nitric acid, uranium, in oxidation states IV and VI, plutonium, in oxidation states III, IV, VI, neptunium, in oxidation states IV, V, VI, nitrous acid, hydrazoic acid (HN<sub>3</sub>), hydrazinium nitrate (N<sub>2</sub>H<sub>5</sub>NO<sub>3</sub>). At the same time, the distribution, for each of these species, interacts with the distribution of the other species involved.

In order to model distribution equilibria, in this operation, it was thus necessary to use an approach based on a representation of liquid–liquid extraction reactions, for the species considered. By way of example, the reaction whereby U(VI) undergoes extraction by TBP is classically represented by way of the following equilibrium:



For this equilibrium, the mass action law takes the form:

$$K_{U(VI)} = \frac{[\text{UO}_2(\text{NO}_3)_2 \cdot 2\text{TBP}]_{\text{org}}}{[\text{UO}_2^{2+}]_{\text{aq}} [\text{NO}_3^-]_{\text{aq}}^2 [\text{TBP}]_{\text{org}}^2} \cdot \frac{\gamma_{U(VI)_{\text{org}}}}{\gamma_{U(VI)_{\text{aq}}} \gamma_{\text{NO}_3_{\text{aq}}}^2 \gamma_{\text{TBP}_{\text{org}}}^2}$$

where [M] stands for the concentration of species M in the phase considered,  $\gamma_M$  for its activity coefficient, and  $K_M$  for the thermodynamic equilibrium constant for this extraction reaction.

To compute the distribution coefficients (partition ratios), as a function of species concentrations, the equilibrium constant must thus be determined, along with the activity coefficients for the various species, in the aqueous and organic phases. An approach of the semi-empirical type was chosen, to determine these distribution coefficients. This approach is based on the observation that activity coefficients, in the aqueous phase, are chiefly dependent on nitrate molality (this being the majority species, in that phase), while those relating to the organic phase show little variation, in the region considered (the organic phase is thus taken as an ideal solution). Comparison of the distribution data, as computed by way of this model, with experimental data is satisfactory, as a whole.

Improved simulation of the distribution of the species involved calls for more precise consideration of medium effects. The first avenue to be explored involves using the concept of simple solutions (Zdanovskii–Mikulin) to compute departures from the ideal case, for aqueous solutions. This approach is useful, since it allows the representation to be refined, along with an extension of the chemical application domain. Ongoing experimental data acquisition work should allow an increase in the number of species taken into account in the model.

### Modeling of interfacial mass-transfer kinetics

In a liquid–liquid extraction process, the aqueous–organic interface is the locus where the complexation reaction takes place, between the solute in the aqueous phase, and the TBP extractant, in the organic phase. Thus, three steps are involved, in mass transfer:

- solute transfer, by way of (turbulent, molecular) diffusion within the aqueous phase;
- the chemical reaction proper, which takes place at the interface;
- solute transfer, by way of (turbulent, molecular) diffusion within the organic phase.

The model selected, in the PAREX code, to represent these three steps is based on the two-film theory, whereby each phase is subdivided into two distinct regions:

- the bulk of the phase, where turbulent agitation results in homogenized concentrations. Within this region, concentrations are constant;
- a thin layer, in the vicinity of the interface, the so-called “diffusion boundary layer,” or “diffusion layer,” in which the fluid flows in laminar fashion. In this region, solute transfer takes place by molecular diffusion, according to Fick’s first law, for the steady state case.

The concentration profile, for the solute transferred from one phase to the other, as obtained by way of this theory, is shown in Figure 62.

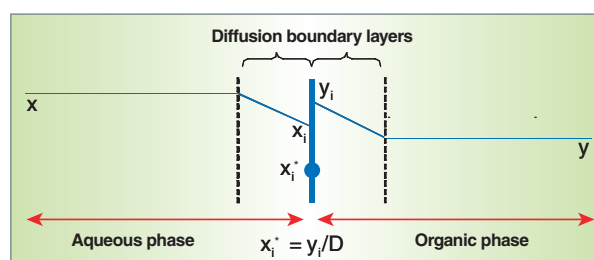

Fig. 62. Transferred solute concentration profile, as derived with the two-film theory.  $x$ ,  $y$  stand for the concentrations in the bulk of the aqueous, and organic phases,  $x_i$ ,  $y_i$  for concentrations at the interface, and  $D$  for the distribution coefficient (related to thermodynamic equilibrium).

The mass transfer flow, per unit area, may be expressed as follows:

$$\Phi = k_x (x - x_i) = k_e (x_i - x_i^*) = k_y (y_i - y) \quad (\text{mol}\cdot\text{s}^{-1}\cdot\text{m}^{-2})$$

where  $k_x$ ,  $k_y$  are the diffusion kinetic mass-transfer coefficients (depending, in particular, on agitation conditions for each phase), and  $k_e$  is the kinetic rate constant associated to the interfacial chemical reaction. It must be noted, in this respect, that the experimental techniques used to measure such mass-transfer kinetics do not, as a rule, allow anything more than overall data to be directly arrived at, subsuming the various steps involved in the transfer.

Mass-transfer kinetics, obviously, is proportional to the interfacial area between the two phases, these as a rule being put into contact in the form of an emulsion, in which drop diameters are determined by breakup and coalescence processes.

In practice, experience shows that the product of interfacial area by the rate constant, which is often estimated by comparing computed profiles with experimental profiles, may be taken to be relatively constant, for a given extraction system and type of contactor, without incurring any notable degradation in computation accuracy.

Ongoing advances in the area of fluid mechanics numerical simulation, and their coupling with chemistry will make it possible to gain a better understanding of breakup, and coalescence processes. Likewise, such techniques should prove valuable, with respect to the interpretation of findings from the experimental methods (e.g.: fixed interfacial area cells, single drops...) used for the determination of mass-transfer kinetics, in particular through a more finescale representation of the steps involving mass-transfer by diffusion, in each phase, close the interface.

---

### Modeling of oxidation–reduction reaction kinetics

A large number of oxidation–reduction reactions may be identified, in the PUREX process. Investigation of chemical reaction kinetics, in this context, is thus a highly complex affair. This shows up in the form of apparent discrepancies between the various kinetic laws found in the literature (discrepancies often accounted for by the different, and as a rule limited, chemical investigation domains involved). While such discrepancies do remain small, as a rule, for reactions taking place in the aqueous phase, such is not the case as regards those occurring in the organic phase (these at the same time being much less investigated). Modeling such redox kinetics thus requires, aside from a compilation/comparison of such laws as have been published, a reinterpretation, in some cases, of kinetic data, if kinetic laws, and constants are to be put forward that may be used over the entire chemical domain that is to be covered by the simulation code.

---

### Modeling liquid–liquid contactors

The various types of liquid–liquid contactors may be grouped into two families:

- stagewise contactors, these including mixer–settlers, and centrifugal extractors;
- continuous contactors, of the pulsed, or agitated column type.

The family of stagewise contactors is characterized by the existence of two regions: a mixing region, where the two phases are emulsified (one phase being dispersed, in the form of drops, in the other), and a settling region, where the two phases separate, under the effects of gravity, or centrifugal forces.

Material balance equations for the model were drawn up on the basis of the following assumptions:

1. The various regions (mixers, aqueous settlers, organic settlers) are taken to be perfectly mixed reactors. Which is tantamount to stating that concentrations, for the various species in a given region, are homogeneous, and identical with those found in the exit stream.
2. No interfacial mass transfer in the settlers (mass transfer being negligible, owing to the highly restricted contact area between phases).

As regards continuous contactors, the behavior of each phase is represented, classically, by way of the piston–diffusion model, this involving, in particular, an axial mixing constant for each phase. Correlations representing the evolution of axial mixing constants for each phase, in the PUREX process, as a function of disk-and-doughnut packed column geometry, and pulsation conditions are available in the literature.

---

### Code qualification

The code qualification step, which is an essential one in the development process, involves two levels. First of all, there is a need to ascertain that elementary processes are properly represented, on the basis of specific experimental investigations (thermodynamic data, chemical kinetics...). With respect to uranium–plutonium partitioning, this has made it possible to ensure a better focus for the data acquisition campaigns being planned, while improving, as far as feasible, our knowledge of reaction mechanisms (see Fig. 63).

The concern then is to achieve global validation for the code, by comparing computed results with findings from tests carried out in laboratory pilot facilities, or even, when these are available, with operational findings from industrial units. It is at this level that the code's accuracy may be gauged, and that

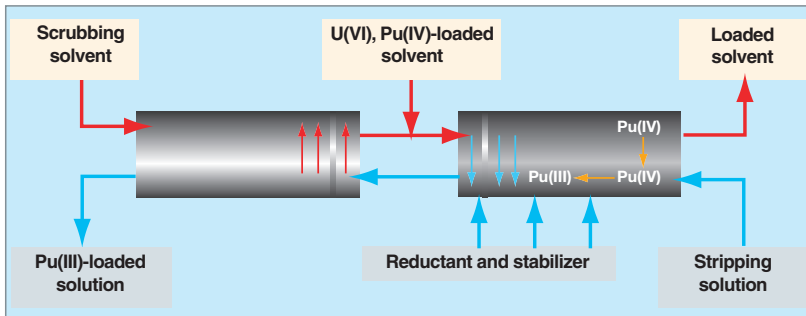

Fig. 63a. A model for the U–Pu partitioning operation [1].

the need may be appreciated, of a reassessment, either of the initial phenomenological analysis, or of the laws used to represent elementary processes.

Since the extraction workshops, in the plants at La Hague, were commissioned, collection of operational data from the main purification workshops has continued, such data being compared with results from simulations, using the PAREX code. Such data collections are effected either when a treatment campaign involving a new form of fuel (MOX fuel, higher-burnup fuel) is carried out, or to support development work for a new plant project. The data make it possible to define precisely the validity domains for the code, and set targets for the evolutions required, that are to be worked on either with regard to operating requirements, or for the purposes of a new plant project.

## Examples of applications of the validated process model

### Flowsheet design/optimization

Such models provide particularly valuable tools, during the preliminary design stages for a workshop. They stand, further, as an indispensable complement to experiments, in that they allow the transposition to the industrial scale of performance measurements carried out in laboratory facilities, or by means of simulation reactants. This is the case, in particular, for the design of extraction workshops, when use of such models makes it possible to characterize the efficiency of extraction equipment, or to predict the performance of complex operations, involving many reactions featuring kinetics of paramount importance (as in uranium–plutonium partitioning, where oxidation–reduction reactions are involved, taking place inside the extraction equipment).

This methodology, involving as it does the transposition, by means of numerical codes, of knowledge gained in the laboratory, was successfully used for flowsheet development, for the extraction workshops at the La Hague plants [2].

The benefits afforded by such models were further confirmed recently, in flowsheet design work for the DIAMEX and SANEX processes, when these models were instrumental in arriving at flowsheets enabling the requisite performance levels, while requiring a limited number of basic data acquisition campaigns, and integration trials.

With respect to operational requirements, the PAREX code remains a valuable tool, for the purposes of detailed process

Modeling the U–Pu partitioning operation [1].

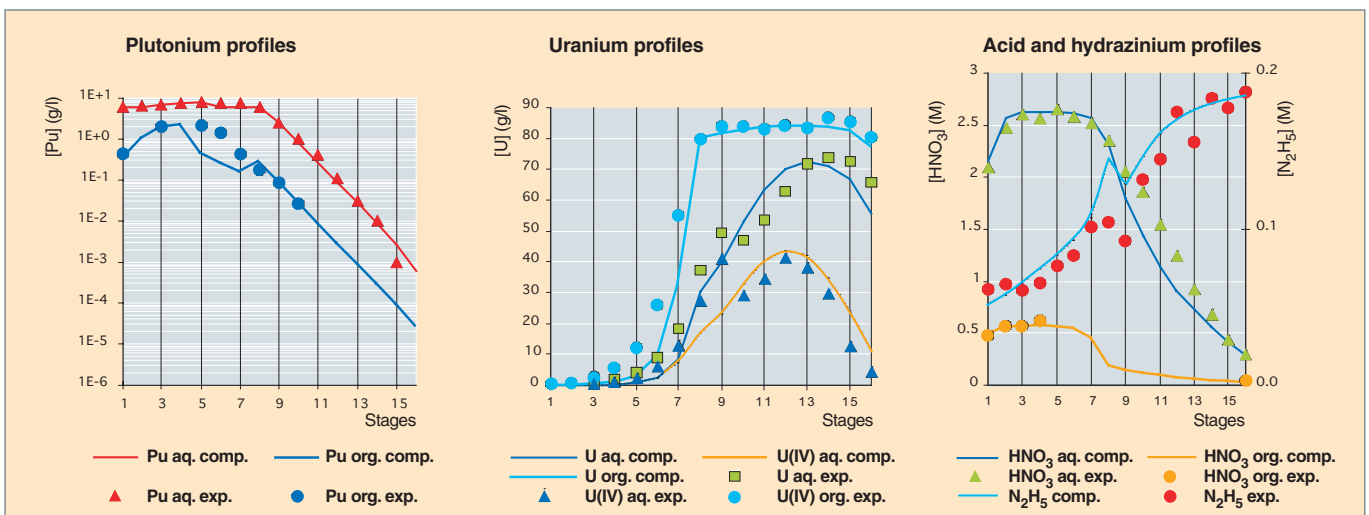

Fig. 63b. Modeling the U–Pu partitioning operation [1].

operation analysis, to understand the causes of observed performance, falling short of expectations, and develop corrective measures. Other uses may involve optimization of operating procedures, or even changes to the flowsheet itself.

### Workshop safety analysis

The availability of models, embodying the knowledge that has been gained, turns out, at the same time, to be indispensable, with regard to the exhaustiveness required in industrial workshop safety analyses. For such analyses, the approach used involves two steps [3]:

1. Analysis of steady state regimes, for the purposes of determining, for each of the operating parameters (flow rates, concentrations in the various streams...), the maximum allowable deviation, with regard to unacceptable phenomena (fissile material buildup, or loss, in the raffinates). This analysis makes it possible, at the same time, to determine the most relevant state quantities, for process control;

2. Analysis of transient regimes, with regard to deviations in the most sensitive operating parameters, this involving an evaluation of process dynamics, in the event of a malfunction; control of the reliability of the state parameters selected for the purposes of process monitoring; and, finally, the development of procedures, allowing the process to be brought back to a predetermined operating state, while strictly complying with operating constraints (as regards safety, in particular).

Sensitivity analyses for each of the extraction workshops at La Hague were carried out, using this methodology, and similar studies are systematically carried out, when there is a change in fuel characteristics.

### Operating aids

Tools to provide operating aids for the extraction workshops were elaborated on the basis of the numerical process simulation models described above. This mainly involves an automatic flowsheet calculation tool (PROCD), allowing adjustments to be made readily to the workshop's operation, to cater for fluctuations in the load requiring treatment, and in reactant flows; and a training simulator (SIMULEX), intended to give operators a better understanding of workshop operating behavior.

Development work is currently ongoing, to bring together in a single tool all of these functions, in order to facilitate on-site access, by non-expert operators, to the code's functionalities.

### References

- [1] P. BARON and B. BOULLIS, "Modelling of uranium/plutonium splitting in PUREX process", Institution of Chemical Engineers Symposium Series, No. 103, *Extraction '87*, Dounreay (UK), 23–26 June 1987, p. 323.
- [2] P. BARON, B. DINH, B. MAUBORGNE, B. GILLET, F. DRAIN, "Plutonium purification cycle in centrifugal extractors: comparative study of flowsheet using uranous nitrate and hydroxylamine nitrate", *RECOD 98: 5th International Nuclear Conference on Recycling, Conditioning and Disposal*, Nice Acropolis (France), 25–28 October 1998, pp. 401–408.
- [3] B. DINH, B. MAUBORGNE, P. BARON, J.-P. MERCIER, "Fuel reprocessing: safety analysis of extraction cycles", OCDE/NEA/CSNI, *Proceedings of the CSNI Specialist Meeting on Safety and Risk Assessment in Fuel Cycle Facilities*, 7–9 October 1991, Tokyo (Japan).

**Binh DINH, Pascal BARON,**  
*Radiochemistry and Processes Department,*  
**Jean DUHAMET,**  
*Fuel Cycle Technology Department*

With contributions by Laurence BERTHON and Philippe Moisy,  
*Radiochemistry and Processes Department*

## Endproduct fabrication with the PUREX process

Once spent fuel treatment is complete, those actinides that are recoverable, for value-added purposes – plutonium, uranium – are as a rule converted to oxide form, subsequent to the separation, and purification operations, in order to condition them in a stable, solid form. In the PUREX process, these two actinides are managed separately, from the first separation cycle on, through to the conversion, into endproducts, of purified solutions of each of the two actinides, as yielded by partitioning in a nitric acid medium.

At the outcome of the treatment, uranium comes in the form of a concentrated uranyl nitrate solution, and its conversion into oxide, which, in most cases, occurs at some later time, is carried out in specific production units, to meet medium- or long-term requirements. A uranyl nitrate solution, and likewise solid uranyl nitrate may, indeed, be conditioned in a form that is relatively stable, over a timescale of a few years. If required, in fairly similar manner to what is the practice with natural, mined uranium, such reprocessed uranium may be used, after re-enrichment, as raw material for the fabrication of fresh UOX fuel.

Plutonium, owing to the specific activity exhibited by its main isotopes, induces radiolysis phenomena which, combined with the constraints of criticality risk management, restrict the feasibility of storing, over extended periods, large volumes of plutonium nitrate solutions. Consequently, subsequent to the extraction and purification cycles, this actinide is converted online to the oxide form, PuO<sub>2</sub>. Conditioning, as regards this particularly stable solid phase, and storage prior to reuse, for value-added purposes, of this material – most of which is fissile – in MOX-type fuel, are techniques mastered at the industrial scale.

### Uranium conversion routes to the oxide form

The chief conversion routes, yielding uranium oxide (irrespective of whether reprocessed uranium [RepU\*] or natural uranium is involved) operate through precipitation, from a solution of this actinide, in the form of a coordination polymer, exhibiting a structure depending on the complexant, precipitant **ligand\***. The initial oxidation state, for uranium in solution, corresponds to oxidation number VI, this being the most stable state, in a nitric medium. Conversion to the oxide form, whether it be to UO<sub>2</sub>, in an inert/reducing atmosphere, or

U<sub>3</sub>O<sub>8</sub>, or even UO<sub>3</sub>, in an oxidizing atmosphere, is effected by means of heat treatment.

The conversion process, operated by Areva since 1996, as regards RepU, involves precipitation in uranium peroxide form, UO<sub>4</sub>, by hydrogen peroxide. In France, one of the main plants carrying out the conversion of reprocessed uranium to the oxide form is Areva NC's TU-5 unit, at Pierrelatte (southern France), which has a maximum capacity of 1,600t/year (output in 2003: 1,518 t U<sub>3</sub>O<sub>8</sub>). The greater part of this oxide, currently, is conditioned, and stored until reused.

Less widely used, conversion routes involving thermal denitration are frequently referred to, in connection with smaller-scale developments, or as a future prospect, the benefits put forward being a limited liquid effluent yield, and enhanced operation compactness. The principle of such methods involves, in more or less rapid sequence, the following steps, under the effects of temperature: concentration, by a dry route, of the uranyl nitrate solution, dehydration of the uranyl nitrate salts obtained, denitration of the solid to the oxide state. Gaseous effluents yielded are H<sub>2</sub>O, and nitrogen oxides (NO<sub>x</sub>), which are easily recycled. More widespread industrialization, in future years, of denitration, for the purposes of uranium conversion into oxide, entails controlling the physical characteristics of the product thus yielded. A recent development by French firm COMURHEX, the Isoflash denitration process, for instance, aims to achieve this, by making use of a thermomechanical effect, arising when the solution is injected into a gas heated to a high temperature, causing instant pulverization, and denitration of the incoming uranium, this yielding a divided oxide, UO<sub>3</sub>, exhibiting the desired characteristics.

### Plutonium conversion routes to the oxide form

The chief route, as regards conversion of plutonium into oxide, involves oxalic conversion.

Two variants have been deployed industrially:

- the first route, based on precipitation of plutonium(IV) oxalate, currently stands as the most widely used one, on an industrial scale, as in Areva's R4 and T4 units, at La Hague (western France), in particular;
- the second route operates by way of plutonium(III) oxalate precipitation, in reducing conditions.

The first option can draw on close to 50 years' industrial background, vouchsafing its robustness, simplicity, and safety in operation.

The second option allows, in certain well-defined conditions, a precipitate to be obtained that is readily filtered, the oxide powder being directly suitable for pelletization, thus making it possible to meet specifically certain requirements, often of a more special nature (e.g., production of PuO<sub>2</sub> dioxide, for sources used in space programs).

The major advantage of oxalic conversion is that this involves a reactant, oxalic acid, that raises no issue with regard to effluents (heat treatment, and recycling of the effluents mainly yielding H<sub>2</sub>O, CO, CO<sub>2</sub>).

Aside from oxalic conversion, peroxide conversion has been used, in some cases, in the United States; while thermal denitration by way of plasma chemistry has been used in Russia, for military purposes.

All of these variants, with respect to the conversion of plutonium into oxide, yield PuO<sub>2</sub>, this being the most stable oxide, in "ambient" conditions. To date, owing to its recycling in MOX fuels, this oxide is the main product recovered, for value-added purposes, from spent fuel treatment by the PUREX process. About 10% of electrical power output, in France, is generated by this recycled material, this allowing concomitant savings in

natural uranium resources, while very significantly bringing down the **potential radiotoxicity\*** of the ultimate waste.

## Production of PuO<sub>2</sub> by oxalic conversion in the Areva treatment plants at La Hague

### Feedback from industrial experience [1]

Oxalic conversion of plutonium(IV) nitrate into oxide has been carried out on an industrial basis for over 50 years, for the purposes of fabricating the chief endproduct from the PUREX process, in the form of conditioned PuO<sub>2</sub> powder.

In simplified terms, the chemical reactions involved in the successive operations, oxalic precipitation, and calcination to the oxide form, may be set out as follows:

- precipitation:

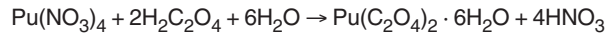

- calcination:

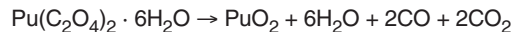

Since this process was first devised – very early on in the history of plutonium – and used on an industrial basis, in particular in the UP1 plant, at Marcoule (southern France), in the

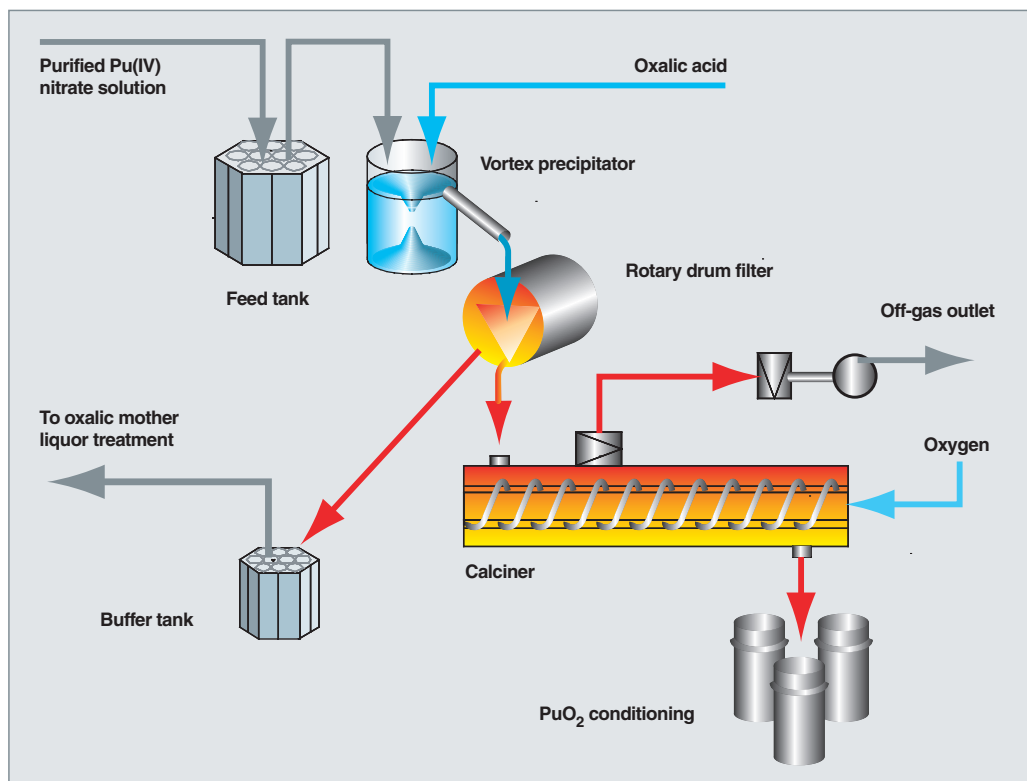

Fig. 64. Principle flowsheet for the continuous conversion process, for Pu(IV) conversion into oxide, as implemented at La Hague.



1950s, and, from 1966, at La Hague, mastery of this process has reached a highly advanced stage. The successive commissioning of the La Hague units – T4 in the UP3 plant, in 1989, and R4 in UP2-800, in 2002 (taking the place of the previous workshop, MAPu) – these currently standing as the main such facilities the world over, ensures a total output capability, for Areva, of more than 100 kg/day.

Precipitation is carried out, on a continuous basis, in a vortex reactor, agitated by means of a magnetized bar, ensuring the outflow of the precipitate suspension into an overflow pipe, thus precluding any buildup of solids inside the reactor. The precipitate is then separated out of the solution, washed, and centrifuge dried, across a rotary drum filter, from which it is continuously fed, by gravity, to the calciner. This is a furnace, featuring a screw conveyor, making it possible to carry out, likewise on a continuous basis, the transformation of the precipitate into oxide, prior to conditioning. The entire production line (see Fig. 64) complies with a subcritical geometry, and is held in containment cells, of the “glovebox” type.

In these conditions, the plutonium oxide produced exhibits homogeneous, reproducible physicochemical characteristics, in terms of purity, grain size, specific surface area, water content, and sinterability, ensuring that the batches yielded meet specifications, to ensure safe conditioning, and subsequent recycling as the chief raw material for MOX fabrication.

### **R&D to support industrial operations: modeling process operations**

Oxalic conversion of Pu(IV) to the PuO<sub>2</sub> form thus involves, essentially, a precipitation operation, yielding plutonium(IV) oxalate hexahydrate from an acidic plutonium(IV) nitrate solution – a laboratory-scale illustration of this is shown in Figure 65 – and heat treatment of the precipitate, in the presence of oxygen, to obtain PuO<sub>2</sub>.



Fig. 65. Oxalic conversion of Pu(IV) into oxide: laboratory-scale tests; left: the vortex precipitation reactor; right (top): washed oxalate precipitate; right (bottom): the PuO<sub>2</sub> conversion product, subsequent to calcination.

The oxalic precipitation step unquestionably determines the chemical purity, and some other properties of the endproduct, owing to a certain selectivity of such precipitation, in optimized conditions (ensuring a higher decontamination factor, with respect to possible residual impurities), and to its yielding a divided solid phase, exhibiting physical characteristics that predetermine those found in the oxide (powder grain size, and the microstructure, more or less as a whole). This specific property accounts for the way this process operation has been – and indeed still is – targeted by R&D studies at CEA/DEN, in particular with a view to finescale modeling, having the ability to take in a large number of the parameters available. This approach, supported as it is by Areva NC, seeks to enhance our knowledge of the process, going beyond industrial experience, to extend it, if required, to meet changes in operating conditions, or in product specifications, while achieving improved precipitator availability (the very gradual buildup of precipitate, inside the reactor, calling for rinsing operations to be carried out a given intervals).

Major studies dedicated to precipitation modeling go back to 1994, and are still currently ongoing, with a view to identify the influence of every process parameter on reactor operation, and ascertain the evolution of precipitate physical characteristics (grain size, in particular).

Nowadays, three types of model are in use, depending on the purpose of the modeling effort, and the degree of precision required:

- a simple, robust system model, for the purposes of taking on board, on a macroscopic scale, the impacts of the main parameters influencing reactant mixing, such as residence time, or reactant injection method, for instance;
- a model involving a finer coupling of local hydrodynamics, inside the reactor, and precipitation chemistry (solubility and supersaturation, nucleation and crystal growth kinetics, crystallite aggregation), by means of a commercially-available computational fluid mechanics (CFD) code;
- a model similar to the preceding one, this one taking into account, however, with regard to mixing, in particular, non-stationary phenomena, using a CFD code developed at CEA/DEN, in Grenoble (France), TRIO-U, specifically configured for the requirements of precipitate microstructural simulation, as a function of chemical, and chemical engineering parameters [2].

Figures 66 and 67 provide illustrations, respectively, of a simulation, coupled to an experimental data acquisition campaign (such coupling is crucial, for the purposes of model development, and model validity evaluation); and an example of findings made recently, using the TRIO-U CFD code.

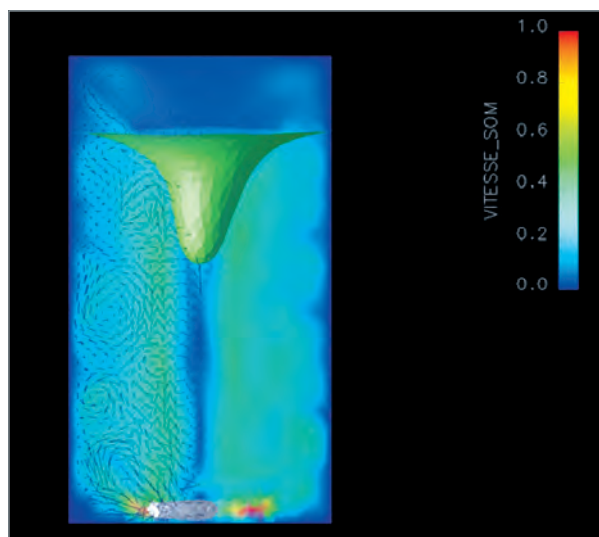

Fig. 66. An illustration of nonstationary regime modeling, involving a large eddy simulation approach for turbulence, using the TRIO-U code, developed at CEA's Grenoble Center: representation of the velocity vector fields across a median plane of the reactor [2].

Until recently, heat treatment of the precipitate, to bring it to the oxide state had often been deemed to be a fairly secondary operation, its implementation being chiefly based on industrial feedback. Indeed, the calciner does not require any specific interventions in operation, once the parameters are calibrated.

Over the past few years, to meet the manufacturer's wish to have the ability to relate precisely process parameters to the chief, abovementioned endproduct characteristics (including some that are dependent on the heat treatment), CEA/DEN first of all detailed anew the reaction sequences involved in thermal decomposition of the precipitate to the oxide form. The mechanisms involved, rigorously ascertained, and compared

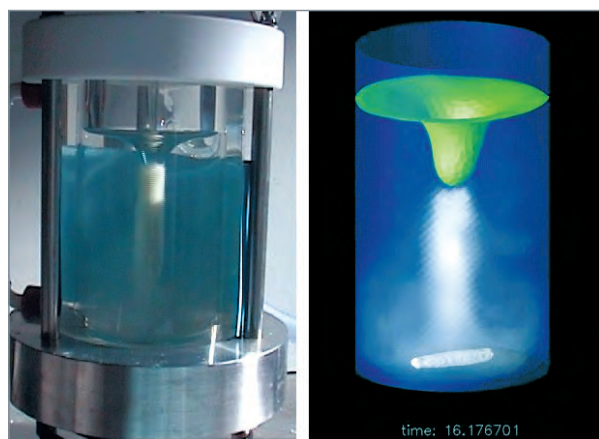

Fig. 67. Left: the initial moments of oxalic precipitation, as the actinide is injected into the forced vortex [Pu(IV) simulated by U(IV)]; right: simulation of tracer injection into the forced vortex [2].

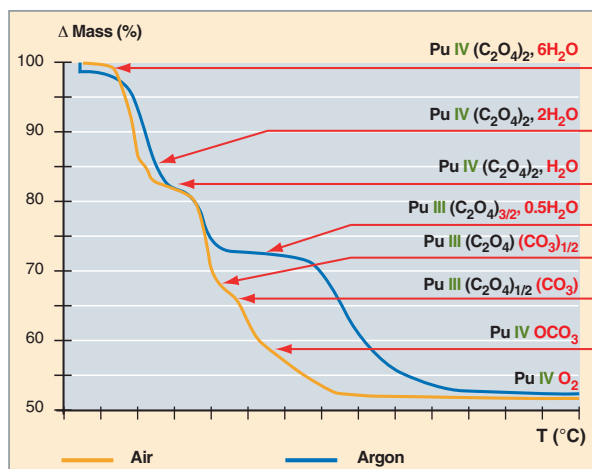

Fig. 68. The steps involved in the decomposition of plutonium(IV) oxalate hexahydrate into oxide, in stationary air, and in argon [3].

with previous state-of-the-art findings, made it possible to identify up to 6 elementary transition reactions (see Fig. 68), from the oxalate hexahydrate structure to the final oxide [3].

This is no straightforward operation, therefore, in chemical terms. The thoroughgoing structural alterations undergone by the solid phase, combined with releases of decomposition off-gases – some of which exhibit instant reactivity, or react during subsequent transformations, within the gaseous phase, or at the solid's surface – significantly alter, and redirect the solid phase's physicochemical characteristics, resulting in those exhibited by the  $\text{PuO}_2$  endproduct. On the basis of the acquisition of these new basic data, a modeling approach, pursuing the same goals as the approach used for the precipitation operation, currently stands at the core of an investigation devoted to the calciners, conducted jointly with Areva's engineering department.

## ► References

- [1] F.-J. PONCELET, J.-P. MOULIN, N. HUBERT, M.-F. DEBREUILLE, S. RUNGE, "Continuous precipitation and filtration, a process technology for liquid waste management", *WM '01: Waste Management 2001 Symposium*, Tucson, Arizona (USA), 25 February–1 March 2001.
- [2] B. ZOPPÉ, O. LEBAGUE, F. DUCROS, M. BERTRAND, "Modélisation de l'écoulement dans un réacteur à effet vortex: étude du mélangeage", *Récents progrès en génie des procédés*, No. 95, 2007: 5<sup>es</sup> Journées francophones sur les réacteurs gaz-liquide et gaz-liquide-solide, Carry-le-Rouet (France), 12–15 June 2007.
- [3] N. VIGIER, S. GRANDJEAN, B. ARAB-CHAPELET, F. ABRAHAM, "Reaction mechanisms of the thermal conversion of Pu(IV) oxalate into plutonium oxide", *Journal of Alloys and Compounds*, 444-445, 2007, pp. 594-597.

**Stéphane GRANDJEAN,**  
Radiochemistry and Processes Department

## Liquid effluent management, and treatment

Spent fuel treatment operations yield radioactive effluents, liquid effluents in particular. Such effluents may not be discharged directly into the environment, and must undergo treatment. The strategy implemented, in current plants, involves carrying out such treatment on line, to preclude a buildup of effluents, by recycling the reactants (nitric acid, solvents), as far as feasible, within the process. The treatment of radioactive effluents is a crucial component, in the nuclear waste management chain. The “process” aspects of effluent treatment is covered in the following pages; while the associated “waste management” aspects are covered in the DEN Monograph on nuclear waste conditioning.

### Aqueous liquid effluents

Such effluents may be classified according to their nature – i.e. as acidic, or basic effluents – and according to radiological activity levels: i.e. as high-level (HLW), intermediate-level (ILW), or low-level (LLW) waste.

#### *Acidic effluents: consigned to vitrification*

High-level acidic effluents originate in raffinates from the first extraction cycle, and concentrates from evaporators fed with intermediate-level effluents. These effluents contain virtually all of the fission products and minor actinides present in clarified dissolution solutions. The effluents come at the highest concentration feasible, taking into account solubilities for the various nitrate compounds, storage tank heat removal capabilities, and equipment corrosion constraints. Such very-high-level ( $10^{14}$  Bq/l) concentrates are consigned to vitrification, to ensure a lasting immobilization of the radionuclides they contain.

To preclude nitric acid concentration rising to excessive levels, the option selected, in French plants, involves keeping acidity constant, during this operation (at a level of about 2 M), through addition of a reducing agent (the “denitration” operation). The two most commonly used reductants are formaldehyde, and formic acid.

With formaldehyde (HCHO), at moderate acidity, the overall reaction is the following one:



With formic acid (HCOOH), the overall reaction stands as follows:

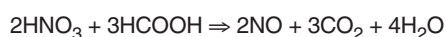

Both reactions yield nitrous vapors (NO, NO<sub>2</sub>), these being recombined into nitric acid, which is recycled in the process, after a step of concentration to some 10–12 M.

The recombination of nitrous vapors is simply effected by scrubbing the off-gases with water (or acid). The overall reaction is:

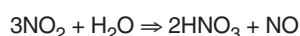

If nitrous vapor recombination is to be as complete as possible, it must involve oxidation of NO to NO<sub>2</sub>, this as a rule being effected in the gaseous phase, using oxygen, or air. This reaction being a slow one, or even a very slow one, at low NO concentrations, it is this step that determines the overall efficiency of the recombination operation.

**Note:** a similar nitrous vapor recombination operation is carried out on dissolution off-gases. However, in the latter case, the recombined acid (at about 3 M acidity) is recycled either directly in the dissolver, or is sent out for the preparation of the acid used for fuel dissolution.

Concentration of the recombined acid is carried out by simple distillation at atmospheric pressure (in French plants). By distillation, acid solutions may be obtained at varying concentrations (up to **azeotropic\*** concentration). In practice, target concentrations, as a rule, stand at 10–12 M.

This concentrated nitric acid, containing tritium as it does, is recycled only in the head end of the process, within the plant’s so-called “tritiated” area. Tritium is subjected, in treatment plants, to specific management.

*Intermediate-level acidic effluents* originate in raffinates from the uranium and plutonium purification cycles. These acidic solutions undergo concentration, the concentrate being col-

### Tritium in effluents

Tritium yielded in the course of fuel irradiation, owing to its low atomic radius, readily diffuses into materials. In the irradiated oxide, such diffusion depends on the thermal gradient set up between fuel centerline and cladding, and, by the end of irradiation, only a fraction of the tritium remains in the oxide. When the fuel is dissolved, the fraction present in the oxide passes into the dissolution solution, in the form of tritiated water. Only a very small fraction (as a rule, less than 1%) escapes to the dissolution off-gases, mainly in the form of tritiated hydrogen. The tritiated water is contained within the upstream part of the plant (in the tritiated area), by means of a “tritium barrier,” involving scrubbing the solvent with nontritiated acid, during the first extraction cycle. Such a management mode entails setting up, within the plant, two separate workshops, for the purposes of nitric acid recovery. The first workshop (RAT: *Récupération acide tritiée* – Tritiated Acid Recovery), sited inside the tritiated zone, treats the raffinates from the first extraction cycle, and effluents from the fission product treatment line. The tritiated acid thus recovered is reused in the fuel dissolution operations. The second workshop (RANT: *Récupération acide non tritiée* – Nontritiated Acid Recovery), located in the nontritiated zone, caters for the other acidic effluents yielded by the plant.

lected with high-level solutions, while the distillate is subjected to fractionation, in the RANT workshop, to yield concentrated (10–12 M), nontritiated acid, which is reused in the extraction workshops in the plant’s nontritiated area.

### Basic effluents

Basic effluents arise from alkaline treatments (with sodium hydroxide, and carbonate) of the solvents, for the purposes of removing acidic compounds yielded by their degradation, due to hydrolysis, and radiolysis. These effluents are directed along different paths, depending on alpha-emitter content.

*The more alpha emitter-rich effluents* arise from the treatment of the solvent used in the first extraction cycle, and plutonium purification cycles. These effluents undergo concentration by evaporation. The distillates are sent to an effluent treatment plant (ETP; in French plants: STE – *station de traitement des effluents*). The reference option, for concentrate management, in current plants, involves vitrification, after mixing with fission products. However, aside from their radioactivity, these solutions contain acidic organic compounds, removed from the solvent (in particular dibutyl phosphoric acid), which are destroyed, to comply with calciner input specifications, either by making use of radiolysis by fission products, or by carrying out an oxidizing treatment upstream of the operation, using hydrogen peroxide (Fenton reaction).

*Low-level effluents*, in terms of alpha emitters, as yielded by treatment of the solvent used in the uranium purification cycles, and by process off-gas scrubbing, are sent directly to the effluent treatment plant.

**Note:** *basic effluents arising from the scrubbing of dissolution off-gases with sodium hydroxide (for the purposes of iodine trapping) are designated, in the La Hague plants, for discharge into the sea, their contamination level falling short of discharge restriction limits.*

### Organic liquid effluents

Specific treatment is required for the solvent, owing to the limited effectiveness of alkaline scrubs applied on line, in each extraction cycle, especially with regard to high-molecular-weight degradation products, and the greater volume of solvent used, this being related, in current plants, to the systematic scrubbing, with solvent, of aqueous streams yielded by extraction operations. This excess solvent is treated by distillation at low pressure, yielding three fractions:

- decontaminated diluent, earmarked for recycling in extraction and scrubbing operations involving diluent;
- decontaminated solvent, featuring a high TBP concentration (about 80% by volume), used to adjust solvent titration in the various extraction cycles;
- a residue, amounting to less than 1% of the solvent treated, carrying most of the radioactivity, and degradation products. This residue, the only organic effluent yielded, is subsequently mineralized, and conditioned in the form of solid waste (see chapter on “Solid waste from the PUREX process”, pp. 79–82).

The equipment used in the current plants, at La Hague, take on board the sensitivity of TBP to thermal degradation, this entailing, owing to the high boiling point of TBP (289 °C, at atmospheric pressure), operating at the lowest pressure feasible, in equipment involving very short residence times. The falling-film technology deployed for this purpose meets these constraints (residence time being less than 1 minute), and doing away with mechanical parts – a source of further constraints, with regard to maintenance within shielded cells – is made possible by opting for simple gravity flow, efficient tube wall wetting being ensured through recirculation of concentrated solutions at the vapor head of the evaporators.

The organic effluent treatment process involves the following main steps (see Fig. 69):

- scrubbing the solvent with dilute nitric acid, to remove water-soluble impurities;
- solvent dehydration, in a falling-film evaporator operated at

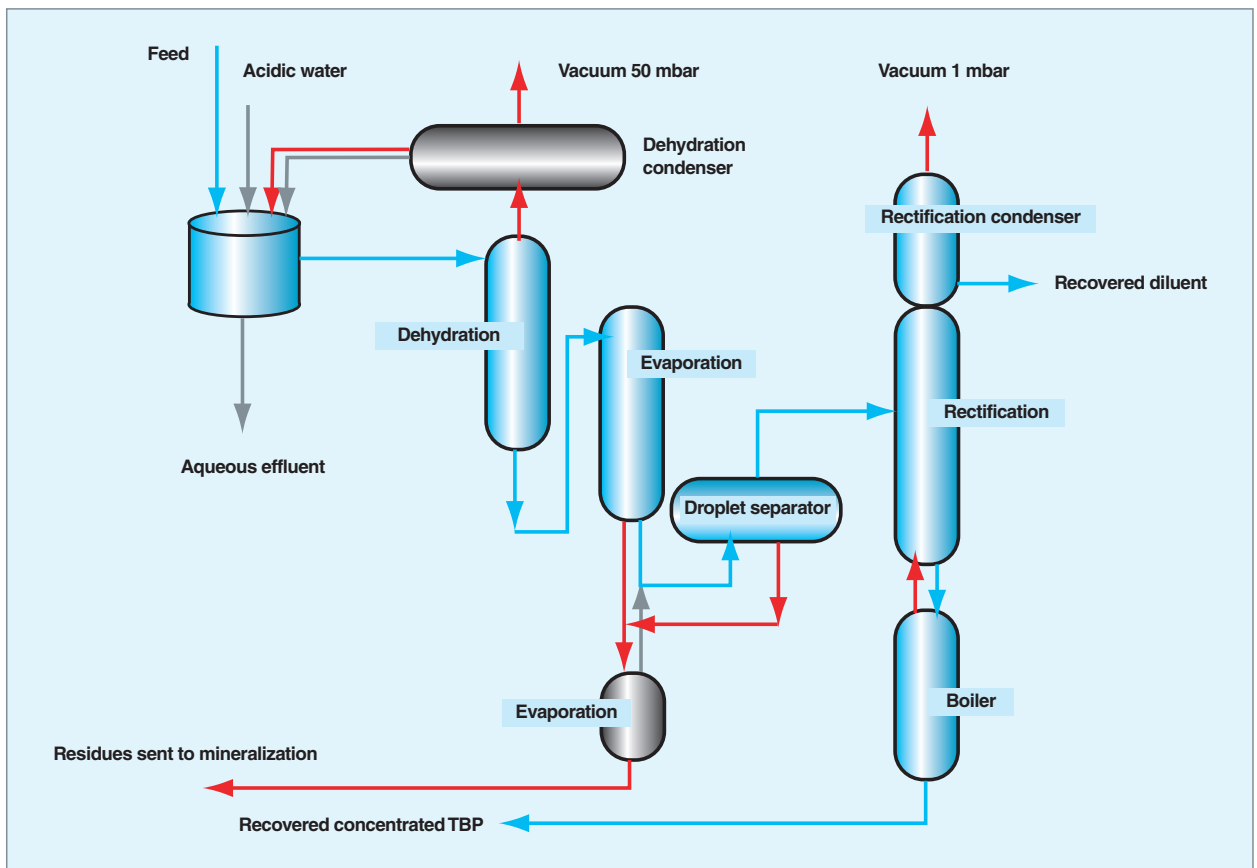

Fig. 69. Principle flowsheet for solvent distillation.

- low pressure (< 50 mbar), countercurrently, to achieve good separation of the two phases;
- separation of the residue thus obtained, through the combined evaporation, at about 5–10 mbar, of the diluent and the greater part of the TBP, in two successive falling-film evaporators:
  - the first evaporator, operating cocurrently, to take advantage of the mixture's lower boiling point, has the object of concentrating the solvent stream by a factor 20;
  - the second one, operated countercurrently, to benefit from a rectification effect, and involving a suitable geometry to cater for the lower flow rate, allows the solution to be further concentrated, by a factor 5, along with isolation of the residue;

- separation, in a rectification column, fitted with very low-pressure-drop packing, of the pure diluent (TBP < 200 ppm) at the head of the column, and a TBP-rich mixture, at the base;
- a droplet separator is inserted between the evaporator, and the rectification column, to preclude any entrainment of radioactivity.

**Isabelle BISEL,**  
*Radiochemistry and Processes Department*



## Solid waste from the PUREX process

A nuclear fuel treatment plant operating the PUREX process yields recovered materials, suitable for value-added use (uranium nitrate, plutonium oxide), and conditioned waste, so-called “ultimate waste,” this chiefly comprising packages holding glasses, serving to condition minor actinides (MAs), and virtually all of the **fission products\*** (FPs), along with packages of structural waste (hulls, end-fittings), containing most of the **activation products\*** (APs) generated during in-reactor irradiation.

Aside from these two categories of waste, there is also a yield of technological waste, in smaller quantities, and exhibiting lower radioactivity levels, associated to operation of the process itself, and further involving specific treatments, and conditioning. For more detailed information, readers may refer to the DEN Monograph *Nuclear Waste Conditioning*.

### Classification of PUREX waste

In such plants, a proactive policy is implemented, aiming to ensure minimization, and the most efficient management of the various kinds of solid waste. The solid waste generated by the PUREX process is usually grouped into two categories: process waste, and technological waste.

*PUREX solid process waste* chiefly comprises:

- fission product solution calcinates;
- insoluble dissolution fines;
- spent fuel structural materials (end-fittings, hulls);
- ion-exchange resins used for storage-pool water treatment;
- iodine traps.

Such process waste undergoes specific conditioning, compatible with its designated outlet (see the DEN Monograph *Nuclear Waste Conditioning*).

The main types of package produced include:

- vitrified fission product packages;
- cementitious waste packages;
- bituminized waste packages;
- compacted waste packages.

*Technological waste* includes operating, or maintenance equipment that has come into contact, or is liable to have done so, with radioactive materials yielded by spent fuel. This cate-

gory thus covers heavy equipment used in maintenance operations, but equally consumables used in normal operating conditions, and expendable wearing parts, such as shear blades, or small items contaminated in the course of interventions carried out by the workforce. Most of this waste, as a rule, exhibits low or very low activity levels, however it may also include high- and very-high-level expendable items of equipment (as, e.g., vitrification pots).

### Process waste, and technological waste treatment, and conditioning

Each category of waste generated in a treatment plant is treated, and conditioned, in accordance with a process that is category-specific. If they meet the technical specifications for surface disposal, packages are sent to a disposal center, such as the repository run by ANDRA in the Aube *département* (north-eastern France). Failing this, they are held in storage, pending availability of a final disposal solution. Conditioning of the radioactive waste arising from spent fuel treatment is carried out on line, in accordance with industrial standards approved by the safety authority. This makes it possible to ensure physical, and chemical stability for the waste, such as to preclude its dispersion into the environment. At the end of the line, this results in an output of packages allowing the waste to be readily handled (see Fig. 70).

The largest stream (in volume terms) comprises the packages serving to condition structural components.

Fragments of metallic fuel cladding (zirconium-alloy hulls, Inconel® assembly end-fittings), recovered subsequent to shearing of the spent fuel assembly, and nitric acid dissolution, are compacted, and conditioned in stainless-steel con-

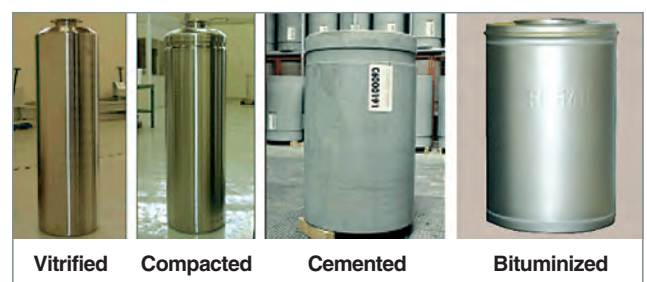

Fig. 70. The main types of waste package.

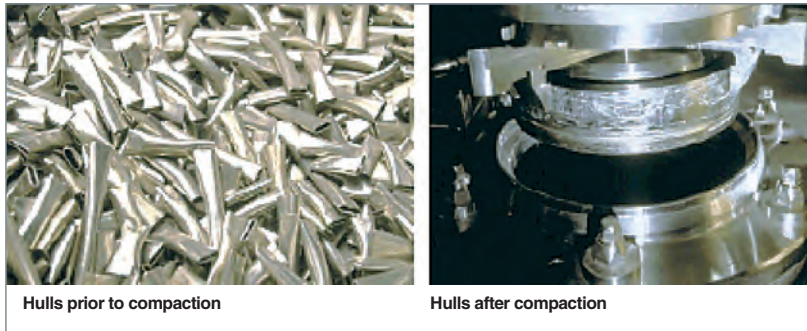

Fig. 71. Hulls before, and after compacting.

tainers (CSD–C: *colis standard de déchets compactés* – standard compacted waste package). Such process waste undergoes compaction, to a volume ratio of 180 liters per tonne treated fuel. Deployment of compaction is a recent development; this has allowed the initial volume to be brought down by a factor 4, as regards this type of waste (see Fig. 71).

High-level technological waste, not suitable for surface disposal, may likewise be compacted, and held in identical stainless-steel containers. The standard compacted waste package (CSD–C) may thus hold fuel assembly structural components, and equally technological waste. Average waste compaction ratio stands at 65%; the pellets thus obtained are stacked in a stainless-steel container, each container holding 7 such pellets. The lids of these containers are fitted with sintered-metal vents, to allow escape of radiolysis off-gases. The package thus put together contains no immobilization material. On standardization grounds, these containers are identical, in terms of outside geometry, to the standard containers used in the treatment of waste consigned to vitrification (CSD–V). The recently commissioned hull compaction workshop at La Hague (western France) is designed for an annual output of up to 2,400 CSD–Cs.

Long-lived, intermediate-level technological waste not amenable to compaction undergoes cementation, this yielding packages that exhibit a mere 0.1% of initial activity.

Very-low-level waste suitable for incineration is conditioned in drums, in a dedicated workshop; it may then be transported to a VLLW waste incinerator (as, e.g. the facility operated by CENTRACO, at Bagnols-sur-Cèze [southern France]).

Short-lived, low-level technological waste undergoes compaction, and is conditioned in metal drums, or encapsulated in concrete.

Resins used for pool water purification are confined in drums, which in turn are held inside metal-fiber–concrete overpacks (CBF–C: *conteneur béton–fibre métallique*).

### Solid waste arising from treatment of aqueous effluents

Glass packages account for the second-largest stream (in volume terms) of solid waste. Solutions of fission products (these are highly radioactive, accounting as they do for 2% of irradiated products, by mass, but 95% of overall product radioactivity) are concentrated by evaporation, prior to storage in stainless-steel tanks featuring cooling and constant agitation systems,

together with scavenging systems, to ensure removal, on a continuous basis, of radiolytic hydrogen. After being held for a time, to allow for radioactivity to fall off, such solutions undergo calcination, and are then mixed with glass frit, to be melted. The glass is poured into stainless-steel containers (CSD–V: *colis standard de déchets vitrifiés* – standard vitrified waste package). Currently, vitrification of the fission products contained in 1 tonne spent fuel yields 130 liters of waste, in the form of radioactive glass, cast in a container complying with the stipulations of control organizations. Glass is presently the most durable (matrix) material to be used, on an industrial basis, to hold and immobilize a broad inventory of highly radioactive radionuclides.

The other processes employed are conducive to recycling, to the maximum extent, aqueous effluents, in order to minimize the amounts yielded, and the activity in the workshops where such effluents were used. In particular, successive evaporation steps allow their decontamination, and the discharge into the sea – once controlled – of effluents thus decontaminated. In the early days of PUREX process operation, quantities of residual, low- and intermediate-level aqueous effluents could be directed to a liquid effluent treatment plant (STEL: *station de traitement des effluents liquides*). Chemical treatment (insolubilization by coprecipitation) allowed the removal of the radioelements contained in these effluents, the resulting low-level (or very-low-level) liquids being discharged into the sea, in compliance with government orders regulating liquid discharges; while the precipitate sludges, once dehydrated, would initially be immobilized in bitumen, and conditioned in drums, prior to storage. Enhanced evaporation capabilities, and improved sorting of the streams at source, combined with significantly enhanced decontamination factors at every stage within the plants, allowed the discontinuation of bituminized waste production, the ultimate concentrated solutions now being merged into a vitrified effluent stream.

### Solid waste arising from treatment of organic effluents

As the chemical purification operations in the PUREX process involve liquid–liquid extraction, the solvent (TBP, diluted in a paraffin hydrocarbon) is chiefly managed by way of scrubbing,



and distillation steps, allowing it to be recycled. Only a very small fraction requires treatment, this involving a pyrolytic mineralization process, and conditioning in a specific workshop. In this workshop, used TBP, blended with 40% waste oils, or diluent, is mixed with magnesium-bearing lime water, and fed into a pyrolysis reactor, inside which heat allows evaporation of the water and diluent, this resulting in a chemical reaction between TBP and magnesium hydroxide. The process separates these products into a jet of gases (butene, butanol, dodecane vapor, nitrogen, and steam), on the one hand, and ashes (a mixture of magnesium oxide, and phosphates), on the other. The gases are filtered, to separate out the fine particles of magnesium phosphate and magnesia dusts. The vapors are incinerated, and incineration off-gases purified, filtered, and discharged through a stack. This installation yields cemented packages, suitable for surface disposal.

### Bringing down volumes, and activity (PURETEX)

Treatment plant waste management optimization has chiefly been pursued under the aegis of the PURETEX program, conducted in compliance with the French Act of 30 December 1991 on radioactive waste management research. This program had the prime purpose of achieving an overall reduction in volume, and activity, as regards the entire yield of intermediate-level waste from a treatment plant, such as that operated at La Hague.

R&D studies, to meet the aims of the PURETEX program, contributed to significant industrial advances:

- optimization of low- and intermediate-level effluent treatments involving evaporation, and the vitrification of evaporation concentrates made it possible to do away with production of bituminized packages, initially used to condition the sludges yielded by the precipitation process; this has resulted in a reduction in waste volume, and marine discharges;
- a hull compaction workshop came on stream in 2002, this taking over from the cementation of structural waste, enabling a reduction, by a factor 4, in the package volume required to condition this waste;
- an alpha-waste conditioning unit (the UCD workshop) was commissioned in 1997. This allows the decontamination of some technological alpha waste, arising from spent fuel treatment and MOX fuel fabrication; after decontamination, 70% of such waste may then be directed to a surface disposal facility.

A further effort was directed at the conditioning for ultimate waste, as yielded by the La Hague plants. Such conditioning has been thoroughly rationalized, over the past decade, with the use of a standard container. The standard waste container

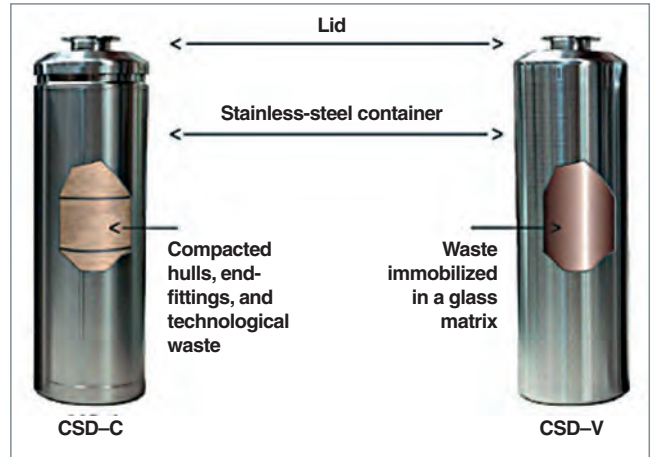

Fig. 72. The standard waste package.

(see Fig. 72) is intended for deep disposal purposes; it can hold most of the long-lived elements generated, i.e. vitrified fission products and minor actinides (CSD-V), and likewise compacted hulls and end-fittings, and technological waste (CSD-C).

Figure 73 sums up the volume reduction achieved, for long-lived, high-level solid waste, through deployment of the developments made as the outcome of the PURETEX program.

Jean-Charles BROUDIC,  
Radiochemistry and Processes Department

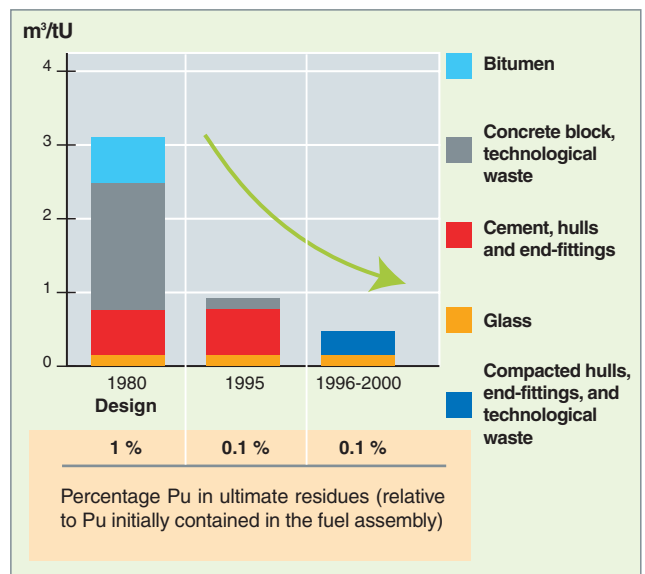
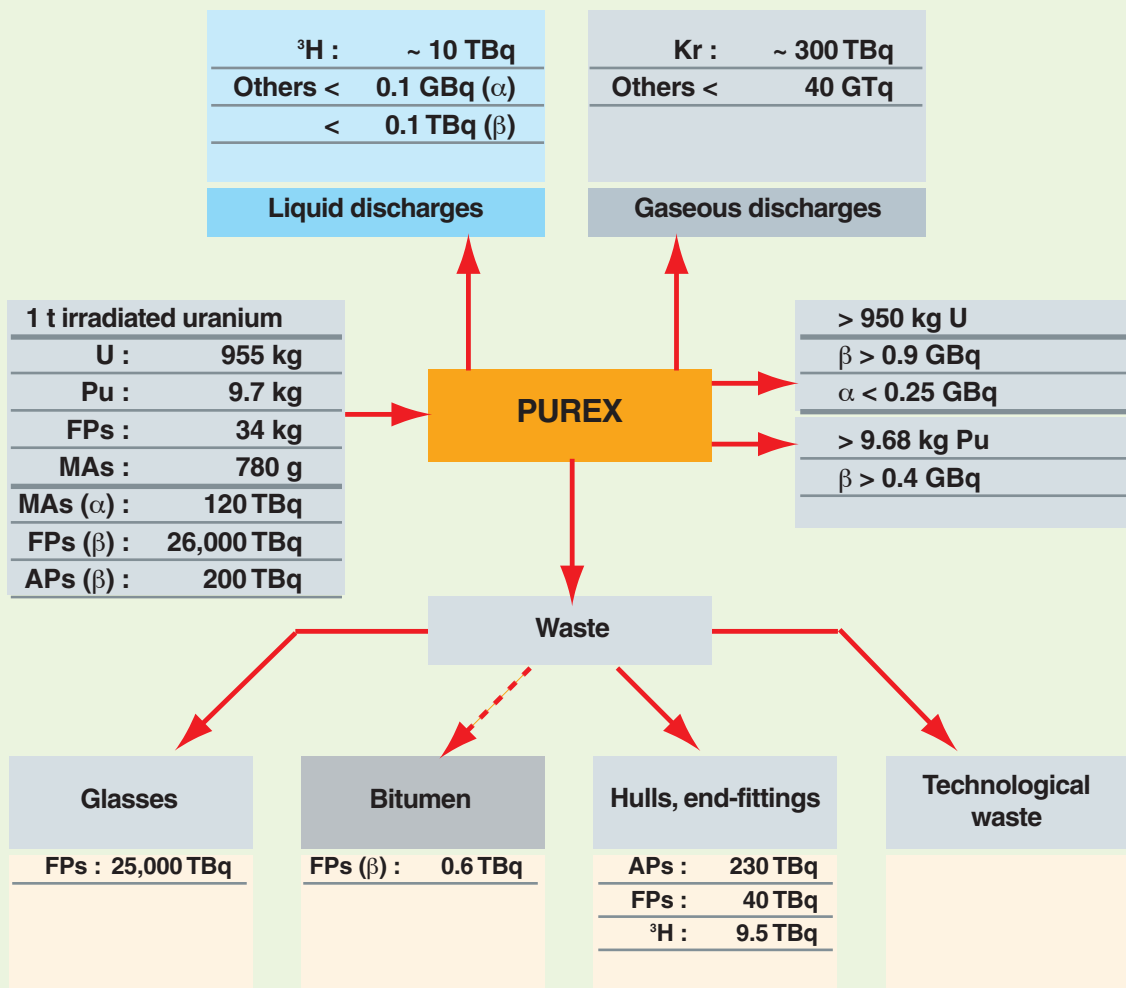

Fig. 73. Evolution of the volume of waste conditioned by the UP-3 plant, at La Hague.

## The PUREX process

Overall balance of the streams involved in the treatment of 1 tonne fuel, in a La Hague-type plant.



# Towards group management of uranium and plutonium: the COEX™ process

## Coextraction of uranium and plutonium: the COEX™ process

The COEX™ process was evolved from the PUREX process, by modifying it to produce a U + Pu mixture (U/Pu > 20%), rather than pure plutonium. The advantage of so doing is to preclude any production of separated plutonium, to curb proliferation risks; this further allows a perfectly homogeneous mixed oxide to be obtained, for the purposes of MOX fuel fabrication, affording enhanced performance.

The proposed flowsheet involves an initial part that is fairly similar to the first purification cycle, as implemented in the UP2-800 plant, at La Hague (France). The extraction part is unchanged: this covers the extraction flowsheet, including

measures to allow removal of technetium. The plutonium stripping part is modified, as regards the uranium scrubbing function. This function has been slightly tweaked, to allow some uranium to remain in the plutonium stream. The function further allows neptunium to be extracted from the plutonium stream, directing the neptunium thus extracted to the cycle's uranium production stream (see Fig. 74).

To ensure the plutonium becomes extractable by the solvent phase again, an adjustment is made to the solution yielded by the first cycle, by raising nitric acid concentration, concomitant with reoxidation of plutonium to oxidation state IV, uranium being adjusted to oxidation state VI. The stream then undergoes treatment in the form of a U–Pu cycle, only involving plutonium extraction, and back-extraction (stripping) functions.

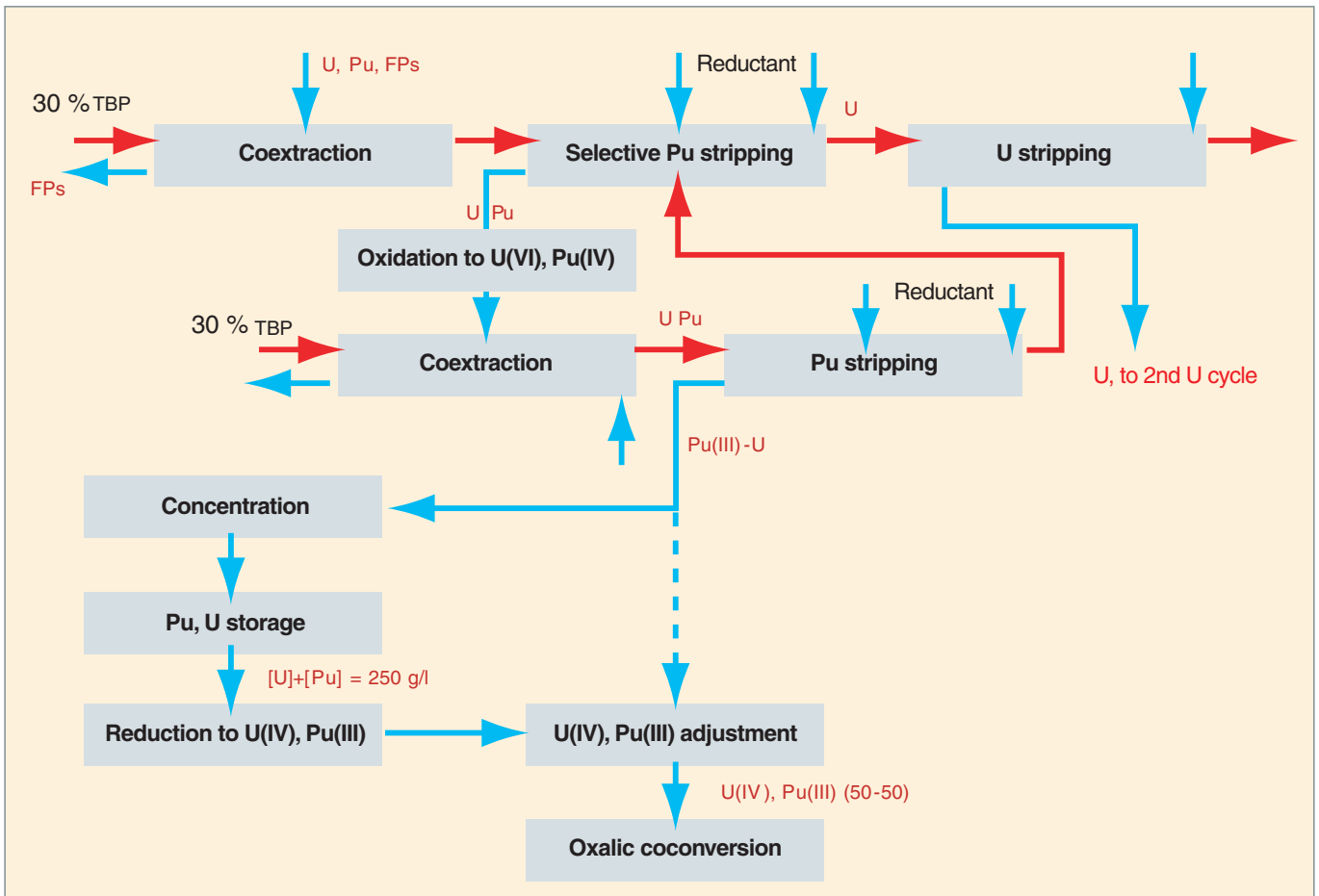

Fig. 74. Principle flowsheet for the COEX™ process.

Reductive plutonium stripping is effected using hydroxylamine nitrate.

Topping up with uranium is provided for, at the head end of this operation, to adjust the Pu/U ratio in the production stream. Finally, the stripped solvent is recycled in the plutonium stripping operation carried out upstream, in the first cycle. This measure makes it possible to tolerate some loss of plutonium to the stripped solvent, and thus limit the number of stages used for the plutonium stripping operation (hence the term “mini-cycle,” for this complementary purification cycle).

### The second uranium cycle

A second uranium cycle, identical to the cycles implemented at the La Hague plant, is further provided for – on the one hand, to complete decontamination of the uranium stream, with respect to  $\beta$  and  $\gamma$  emitters, and, on the other hand, to ensure removal of neptunium.

The separation flowsheets used in the COEX™ process can draw on the expertise accruing from the design, and deployment of the PUREX process, but equally from operational feedback with that process. The design for the extraction cycles has extensively relied on a simulation tool, validated by experimental investigations carried out for the workshops at the La Hague plants, and equally by comparisons with findings from industrial operations. Variants for the flowsheet have, at the same time, already been suggested, to allow for evolutions in the near future, to cater for neptunium recycling.

### Coconversion of uranium and plutonium with the COEX™ process

Joint conversion of uranium, and plutonium makes it possible to do away with the complicated step of blending and cogrinding distinct oxide powders, as currently employed for the purposes of MOX fuel fabrication.

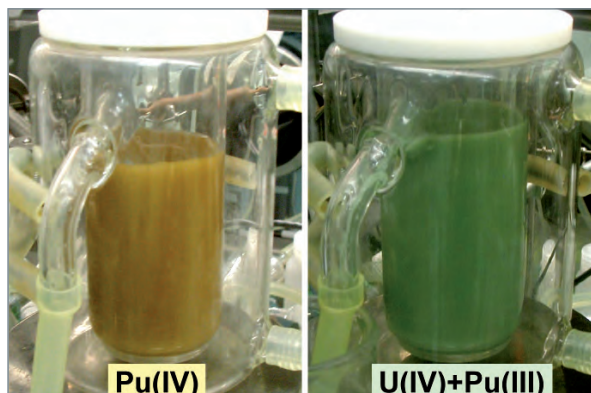

Fig. 76. Left: oxalic precipitation of Pu(IV) (1:60 scale relative to the vortex reactor [VR] used in current PUREX process workshops, at La Hague); Right: oxalic coprecipitation of U(IV) and Pu(III) by the COEX™ process (ATALANTE).

Over the past few years, a number of coconversion routes have thus been revisited, or devised on the basis of original chemical principles, in order to innovate in the area of uranium and plutonium management. CEA/DEN, in partnership with Areva NC, is proposing to extend oxalic conversion of Pu(IV) to oxide – drawing on 50 years’ feedback from industrial experience as this does – to the oxalic coconversion of uranium and plutonium (see Fig. 75).

Operating in conjunction with the COEX™ process, no new reactant is involved, this facilitating future safety studies. Similar chemical engineering may be considered, or optimized with no real technological discontinuity required (see Fig. 76).

As regards coconversion, the innovation chiefly concerns the adjustment of chemical conditions, to cater for the quantitative coconversion of the two actinides, whether in the same oxidation state or otherwise; controlling the yield of mixed oxalate

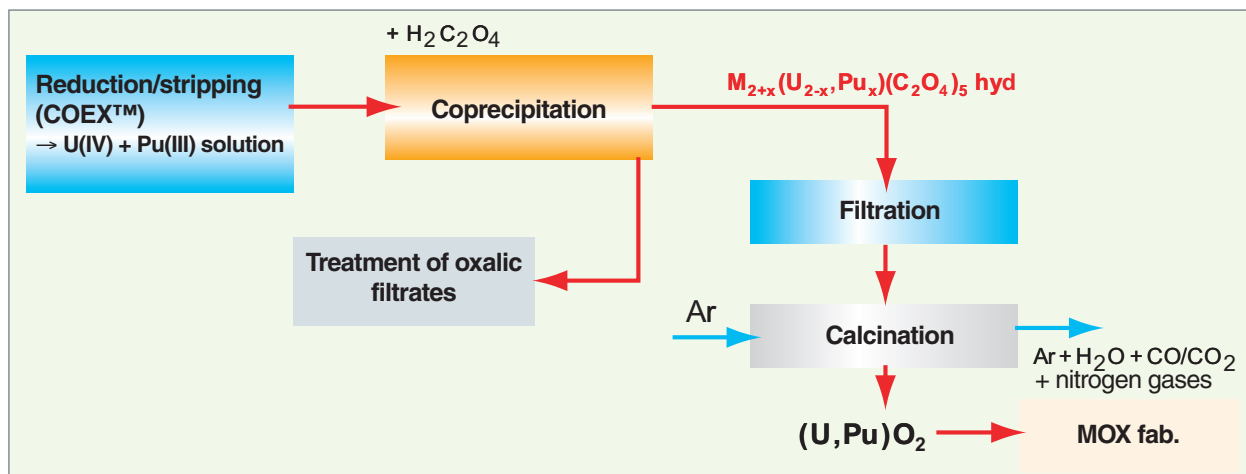

Fig. 75. Flowsheet for oxalic coconversion of uranium and plutonium into oxide.

structures; and developing conditions for the calcination of the coprecipitate to an oxide form exhibiting an oxygen/metal ratio close to 2.0 [i.e. to a mixed oxide of the (U,Pu)O<sub>2</sub> type], while ensuring the effective removal of carbon residues. Target ceramic quality, for the mixed oxide powders, should it prove equivalent to that currently achieved for PuO<sub>2</sub>, would allow simplifying, or even doing away with the upstream powder blending and cogrinding steps, involved in fuel fabrication using a process of the MELOX type. The major advance, indeed, involves replacing these upstream steps by a mere dilution operation, for the mixed oxide yielded by coconversion with UO<sub>2</sub>. With further advances, involving suitable chemical engineering to cater for high output capacities for the coconversion operations, elimination of this dilution step could become feasible, resulting in the direct pelletization of powder yielded by coconversion, with the target Pu content.

### Variants of the uranium and plutonium coconversion process into oxide, and selection of U(IV)–Pu(III) as reference

Of the various possible variants, investigated at CEA, the current reference route is the U(IV)–Pu(III) variant, owing to the following advantages [1]:

- unexpectedly, U(IV) and Pu(III) cocrystallize into a single oxalate structure, thus ensuring homogeneous distribution of the two actinides, at the molecular scale (see Fig. 77). This structure is an oxalate solid solution, over a broad range of Pu/(U + Pu) ratios: 0–50 mol/mol;
- this mixed oxalate exhibits very low solubility, in a nitric acid solution carrying excess oxalic acid: solubility is about the same as that of the plutonium(IV) oxalate precipitate obtained in the current workshops at the La Hague plant, ensuring coprecipitation efficiencies higher than 99% for uranium and plutonium, and, consequently, good control of actinide composition in the mixed solid;

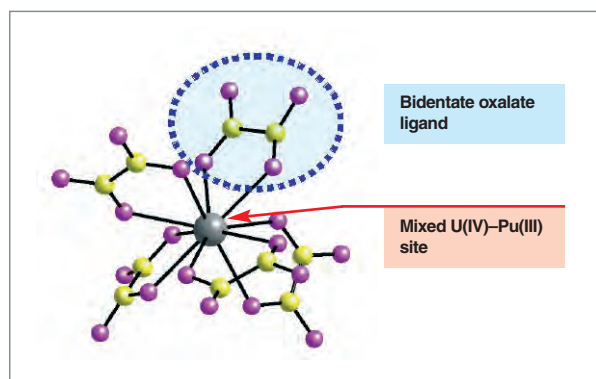

Fig. 77. Representation of the cocrystallized U(IV)–Pu(III) mixed oxalate structure [2].

- calcination of this mixed oxalate in an inert atmosphere yields a solid solution of (U,Pu)O<sub>2</sub> oxide; the homogeneity of uranium and plutonium distribution, at the molecular level, is thus conserved, from the solution to the oxide;
- technology similar to that operated in the current plutonium endproduct workshops at La Hague may be used; or, to meet requirements for higher output capability, adaptation of a known industrial reference may be opted for.

This variant of the coconversion process thus affords unquestionable advantages, with regard to advanced fuel cycles, and with respect to new plant projects, referred to an international context where the concern is to curb proliferation risks, while making the fuel cycle as economical as possible, with stringent safety requirements.

A major goal, for oxalic coconversion, is to produce mixed oxides exhibiting physicochemical characteristics directly tailored to fuel fabrication, affording, in particular, *the ability to use this raw material directly, with no further specific chemical, or mechanical treatment*. Relying on a precipitation step, combined with known chemical reaction engineering, makes this goal an achievable one, with regard to the following physical characteristics: grain size, particle morphology, specific surface area. At the same time, on the basis of the mastery, at the industrial scale, of the oxalic conversion of Pu(IV), knowledge of the reaction mechanisms involved in the transformation of the mixed U–Pu oxalate into oxide should allow oxides of great purity to be obtained, exhibiting the target O/(U + Pu) molar ratio.

Safety and installation availability criteria, of course, are crucial: any transformation of a solid at high temperature remains a complex operation, giving rise to a multiplicity of chemical reactions, which must be controlled in normal, as in degraded conditions; such continuous operation, by way of oxalic coconversion, is feasible, yielding a coprecipitate that exhibits filterability and pourability equal to those of the Pu(IV) oxalate processed in current plants, with due adjustments to the conditions for calcination to oxide form.

More broadly speaking, from PUREX to COEX™, the evolution to an oxalic U–Pu coconversion process, combined with a process adapted from a MIMAS-type process, affords the following advantages:

- a process yielding a uranium–plutonium mixture, without at any point involving the handling of separated plutonium, thus reducing proliferation risks;
- the (U,Pu)O<sub>2</sub> oxide solid solution obtained from coconversion, as the endproduct of spent fuel treatment by the COEX™ process, and raw material for the fabrication of advanced MOX fuel, results in an enhanced homogeneity of plutonium distribution within the fuel (compared with the current

upstream cogrinding operation, of  $\text{UO}_2$  and  $\text{PuO}_2$  powders), meaning improved in-reactor behavior may be anticipated, for fuel fabricated from such raw material, bringing benefits with regard to increased burnups;

- reduced installation contamination, and limited exposure to radiation, during fuel fabrication using COEX™-produced powder;
- a further outcome would be simplified management of fabrication scrap, and a likely improvement in MOX fuel solubility, subsequent to irradiation (no  $\text{PuO}_2$  islands).

#### ► References

- [1] S. GRANDJEAN, A. BÉRÈS, J. ROUSSELLE, C. MAILLARD, "Method for co-precipitation of actinides in different oxidation states and method for preparation of mixed actinide compounds", patent No. WO/2005/119699.
- [2] B. ARAB-CHAPELET, S. GRANDJEAN, G. NOWOGROCKI, F. ABRAHAM, "Synthesis of new mixed actinides oxalates as precursors of actinides oxide solid solutions", *Journal of Alloys and Compounds*, 444-445, 2007, pp. 387-390.

**Binh DINH and Stéphane GRANDJEAN,**  
*Radiochemistry and Processes Department*

## Technological options for treatment, and recycling

Options, as regards treatment and recycling, depend on the various strategies being considered – with respect to fuel recycling, for the nuclear reactors of the future, and waste management – best able to comply with the chief criteria set by the Generation IV International Forum, such as conservation of resources, cycle economics, safety, reduced waste radiotoxicity, and proliferation resistance. These options further derive from the following directions, and considerations:

- industrial deployment of treatment–recycling plants must be effected in a manner consistent with the evolution scenario for the reactor fleet (Generation II/III → Generation IV transition). Thus, as may be seen in Figure 78, the French reactor fleet should comprise, at least up to the end of the present century, a mix of Generation-III reactors (EPRs), and Generation-IV reactors (fast reactors [FRs]). Cycle plants should thus have the capability, through that interval, to cater equally for “light-water,” and “fast” fuels, and their refabrication;
- advances in research mean it may be anticipated that the first fourth-generation reactor to be deployed industrially will be a sodium-cooled reactor, featuring an oxide driver core (this being the option involving least industrial risk). However, as the interest evinced for carbide fuels, and gas-cooled (high-temperature) reactors remains at a high level, a switch to such fuel, and reactor lines of this type may be expected.

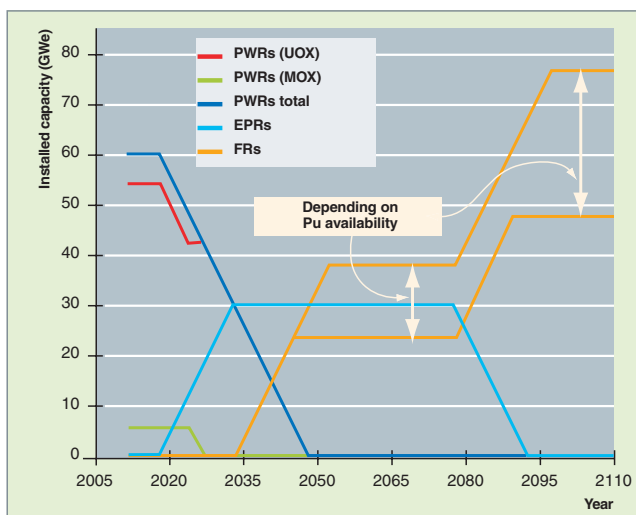

Fig. 78. EDF scenario for the deployment of the French reactor fleet.

Treatment/recycling process and technology design will need to take on board such evolutions;

- recycling of long-lived fission products is fraught with difficulties, and is not being considered (see the section on the transmutation of separated actinides, pp. 151–165). As regards minor actinides (americium, neptunium, curium), recycling is planned only in Generation-IV reactors, or ADSs. In such a context, the two transmutation pathways that may be envisaged – homogeneous minor actinide recycling, in a driver core; or heterogeneous recycling of minor actinides, held in dedicated assemblies, or targets – remain open, as of now. Likewise, the benefit of curium recycling has yet to be evaluated;
- in order to limit industrial risks, cycle process and technologies should involve – at least as regards initial plant evolution – no discontinuity with the process, and technologies used in current French cycle plants (La Hague and MELOX). This principle, favoring as it does deployment of an improved version of the PUREX process, leads to promoting, initially, the multirecycling of uranium, and plutonium, going on to deploy, gradually, dedicated minor actinide recycling units. A recycling plant deployment scenario is set out in Figure 79, in step with the transition for the reactor fleet: Generation II → Generation III → Generation IV. This gradual approach to actinide recycling (uranium and plutonium initially, followed by minor actinides) in Generation-IV reactors entails the development, and deployment of mutually compatible treatment, and recycling processes: output endproducts from the former exhibiting the characteristics of input products for the latter;
- enhanced cycle proliferation resistance will, in all likelihood, entail, as regards the new plants – aside from more stringent online control of plutonium – use of processes precluding any output of streams of materials liable to be used directly for proliferation purposes, and, ultimately, integrated treatment and recycling operations (spent assemblies being taken in at one end of the plant, while reactor-ready assemblies are turned out at the other end);
- the prospect of a nuclear energy industry providing for improved waste management means that major industrial challenges may be anticipated. CEA is preparing for this, by making available to manufacturers as wide a spectrum as possible of process components, and technical solutions,

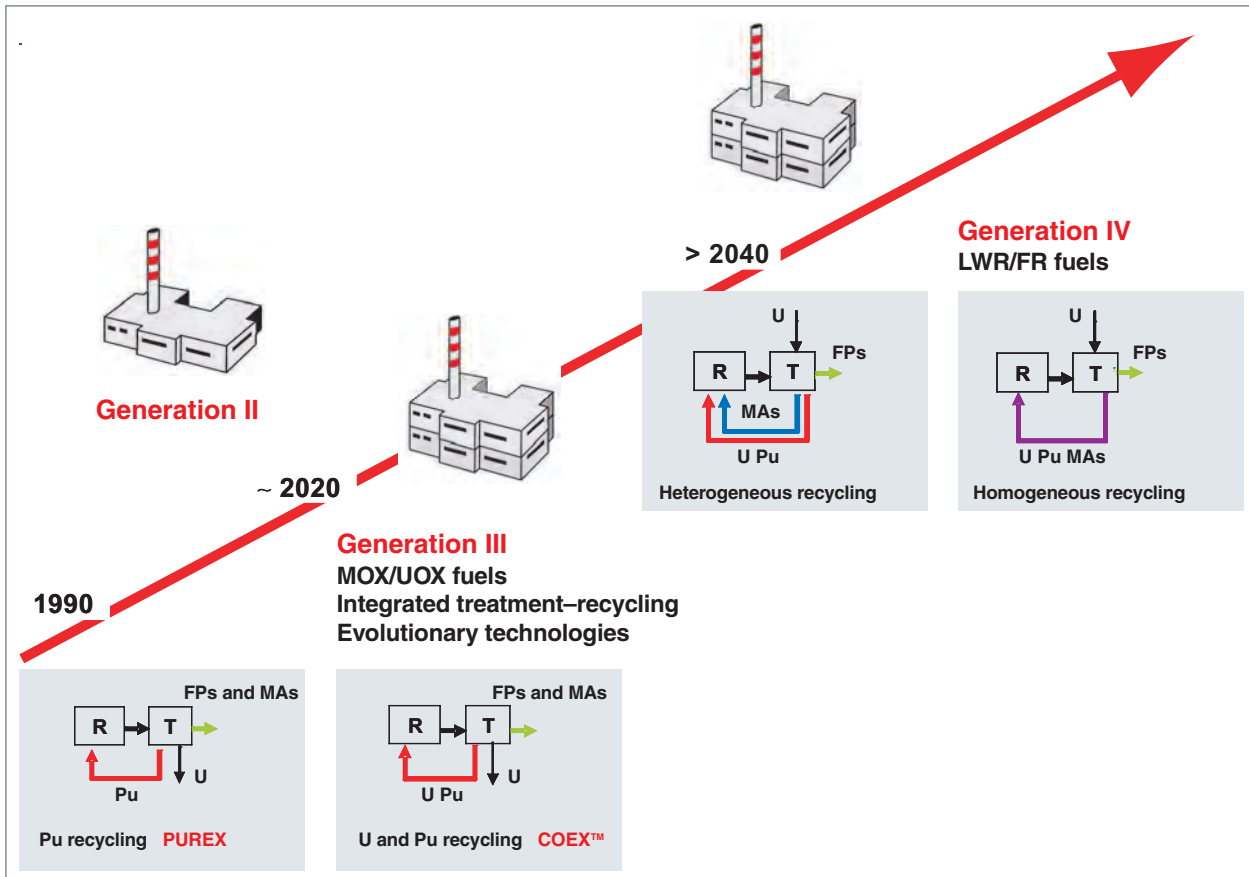

Fig. 79. Transition scenario for recycling plants, from Generation II/III to Generation IV.

ranging from the recycling of Pu only, through to full actinide recycle. This entails, of course, as a prerequisite, the qualification, and demonstration of the robustness of each of the recycling processes being considered.

The desire to ensure, on the one hand, lasting viability for the fuel cycle, and, on the other hand, the industrial decision to go, as a first choice, for an evolutionary technology, relative to extant processes, leads to making the PUREX process evolve towards joint management of uranium and plutonium, from the first treatment step through to the final, fabrication stage. The COEX™ process, developed for that very purpose, makes it possible to promote the uranium and plutonium multirecycling option (conservation of resources), while guaranteeing the absence of any stream of pure plutonium in the plant (providing enhanced cycle proliferation resistance). Further, the process's flexibility should allow treatment of various types of ceramic fuel (oxide, carbide, and possibly nitride, if required), whether coming from thermal, or fast-neutron reactors. Finally, a simple adaptation of the process makes it possible, with no modification to liquid–liquid contactor configuration, to ensure neptunium management, on a customized basis, whether on its own, or quantitatively combined with the U and Pu stream.

As regards minor actinides, the goal of recycling, at minimum cost, at least 99% of the americium, neptunium, and curium from spent fuel directed, very early on, the research thrust to look to hydrometallurgical separation processes, to be set up downstream of the PUREX process, working on raffinate solutions of fission products, subsequent to removal of the elements uranium and plutonium – the chief contributors to the metal load picked up by extractants. This option affords the advantage of being amenable to deployment in liquid–liquid contactors suited to a nuclear environment, of well-proven robustness. Thus, the option of partitioning minor actinides from the PUREX raffinate solution – more commonly referred to by the acronym “DIAMEX–SANEX process” – in liquid–liquid contactors similar to those used in the technologies deployed at La Hague (pulsed columns, mixer–settlers, centrifugal extractors) underwent technological demonstration, at the scale of about 10 kilograms spent fuel, in 2005. It should be noted that effluent management, for this process, is compatible with current effluent management practice, for a PUREX plant. This approach, of hydrometallurgical separation, was likewise retained for the development of the process ensuring the further separation of americium and curium, from the minor actinide production stream yielded by the DIAMEX–SANEX process. Thus, as may be seen from Figure 80, a full spectrum of processes is now available, compatible with actinide recycling in the heterogeneous mode, that may



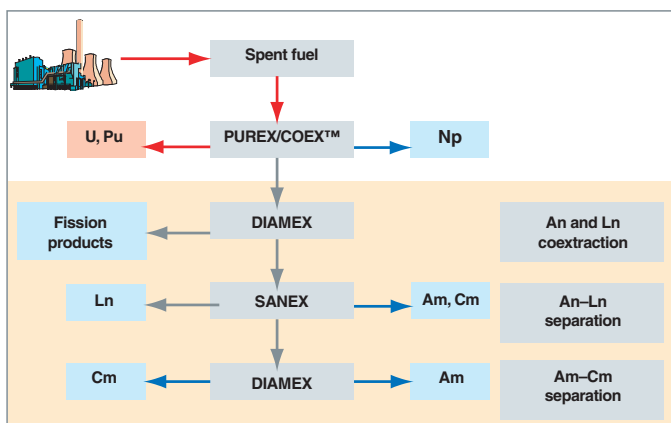

Fig. 80. Minor actinide separation processes.

complement on line the PUREX and COEX™ processes. Research work is ongoing, to optimize the flowsheets, and streams, or even to simplify them, by going for the sole separation of americium, in the event e.g. of the decision not to recycle curium being finalized.

The recommendation, by the Generation IV International Forum, of full actinide recycle led to the **GANEX\*** concept, of group separation of the metallic elements uranium, plutonium, neptunium, americium, and curium. A flowsheet for the concept is set out in Figure 81.

This concept – affording the fullest features, with regard to proliferation resistance – does not stand as a further step, to complement the PUREX, COEX™, DIAMEX, SANEX processes, developed with a view to the gradual deployment of actinide recycling – consistent with a mixed fleet of operational power reactors – rather it supplants them. Owing to the difficulty of arriving at a selective molecule that would ensure group actinide extraction, chiefly due to the complexity, and simultaneous occurrence of the elements requiring extraction, in ox-

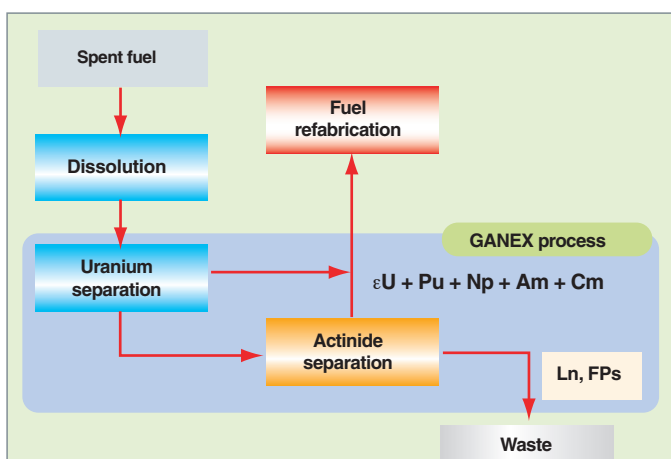

Fig. 81. The GANEX homogeneous actinide recycling concept.

idation states III to VI, the option was taken to separate uranium, as a first step, by means of an oxidation state VI-specific extractant, the DIAMEX–SANEX process being modified to cater for the further coextraction of plutonium. Scientific demonstration of the two steps in the GANEX process is scheduled to take place in ATALANTE, in 2008. It should be noted that this two-step concept for actinide separation – uranium first, followed by the other actinides in the second step – while it may be at odds in terms of purposes, is very close, in principle, to the UREX process developed by Argonne National Laboratory (US DOE) (see Box on “The US UREX actinide partitioning process”). A technology watch is also being kept on other processes developed outside France: NEXT (New Extraction System for TRU Recovery), in Japan; REPA (Recycling Plutonium and Minor Actinides), in Russia; NUEX (New Uranium Extraction Process), in the UK...

#### The US UREX actinide partitioning process

In the United States, plutonium had not been deemed, so far, to be a recoverable material, rather it was seen as waste involving a high proliferation risk. To optimize the disposal footprint of spent fuels, uranium in these, alone, accounting for some 96% of the mass, US researchers have adapted the PUREX process, to separate the uranium only (UREX scheme, for “Uranium Extraction”), while the plutonium remains with the fission products, and minor actinides. For the purposes of plutonium separation, in order to achieve a reduction in the long-term impact, at the outlet, of waste consigned to deep disposal, UREX is complemented by the two-step group separation of remaining actinides (TRUOX, acronym for Transuranium [TRU] Extraction; and **TALSPEAK\***, for actinide–lanthanide partitioning). To do away with the need for a protracted storage time, to allow for heat-generating fission products to decay, the process involves, upstream of UREX, a specific cesium and strontium separation cycle. A flowsheet for the full UREX process is set out in Figure 82. To sum up, UREX, developed for the purposes of standard UOX fuel treatment, does not stand as one single separation process, but rather as a sequence of “separative functions.”

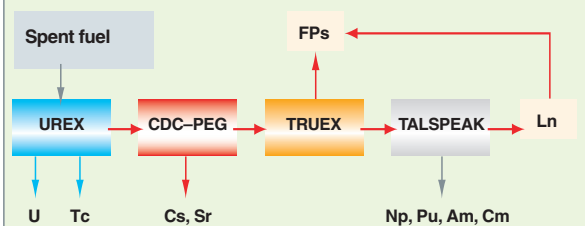

Fig. 82. The UREX process, an actinide and heat-generating fission product separation concept, developed in the United States.

The options, as regards minor actinide recycling mode (homogeneous, or heterogeneous), type of assembly, or dedicated target (ceramic, metal, cermet...), and transmutation system (Generation-IV reactor, or ADS hybrid system), are still open. As regards **transmutation\*** in an ADS, targets involving a high minor actinide content will be subjected to heavy irradiations. For the treatment of such highly irradiated, minor actinide-rich targets, or fuels, a pyrochemical route, as an alternative to conventional hydrometallurgical processes, has been investigated. The general properties ascribed to molten halide salts (ability to dissolve refractory compounds, high radiolysis resistance, low neutron moderation capability) make this a useful concept. Work has thus been carried out, to develop a process whereby actinides undergo separation in a molten salt bath, target actinide separation and recovery performance being set at more than 99%.

Finally, conversion operations, to turn actinides into a solid suitable for recycling, and recycled fuel fabrication, are indispensable if the cycle is to be closed. A broad consensus has emerged, favoring an adaptation of oxalic conversion processes, of actinides into the oxide form, and of fuel fabrication by means of powder metallurgy, as already used in existing plants, for the purposes of plutonium conversion, and MOX fuel assembly fabrication. These reference pathways, for the

fabrication of mixed actinide oxide fuels, whether (U,Pu)O<sub>2</sub> and (U,Am,Np,Cm)O<sub>2</sub> (heterogeneous actinide recycling), or (U,Pu,Am,Np,Cm)O<sub>2</sub> (homogeneous recycling), have reached the qualification stage (fabrication of a few hundred grams compounds, and irradiation in the **Phénix\*** reactor, to investigate the behavior of some of these materials in a fast-neutron flux). Other conversion routes, involving e.g. use of a sol-gel process, or fabrication by extrusion are still at the research stage. The feasibility of actinide coconversion into mixed oxide form now being a settled matter, investigations are being undertaken regarding the carbothermic conversion of actinide mixed oxides into carbides, and are being closely monitored, since mastery of such processes may turn out to be a major challenge, with regard to fabrication of the fuels of the future.

Separation processes, recycling processes: France will be able to avail itself, by 2012, of the technological components allowing the major options to be decided, for the future deployment of the actinide recycling pathway, thus complying with the requirements set by the French Act of 2006 on radioactive material and waste management.

**Michel Masson,**  
*Radiochemistry and Processes Department*

## Generation-IV reactor fuels

The characteristics, and specific features of the reactors of the future may not be considered in isolation, without reference to the fuel cycle involved. Which is why, nowadays, the term “nuclear system” is used, this referring to the ensemble of core, fuel, and associated fuel cycle.

The present section sets out to describe the fuels being considered for such reactors of the future, with reference to the specific aspects involved in the treatment and recycling of these fuels. For more detailed information, as regards fourth-generation reactor fuels, readers may refer to the DEN Monograph *Nuclear Fuels*.

Of the six nuclear system concepts selected by the Generation IV International Forum, CEA has opted to pursue three: the sodium-cooled fast reactor system (SFR), the gas-cooled fast reactor system (GFR), and the very-high-temperature reactor system (VHTR), and is launching development studies, with a view to industrial deployment by 2050. For the record, the three other concepts in the running are the lead-cooled fast reactor system (LFR), the supercritical-water-cooled reactor system (SCWR), and the molten-salt reactor system (MSR).

### Choice of fissile material

Generation-IV fast-neutron reactor (fast reactor) fuel will have to meet novel specifications, compared with those for EPR fuel, for instance, in particular with regard to high fissile material density (entailed by a smaller core volume, at constant

power, and zero breeding gain operation), thermal properties (a high temperature gradient being set up between fuel centerline and rim, core volumetric power reaching some 200–400 W/m<sup>3</sup>, with considerable heat transfers to the coolant), the whole element being clad with a material exhibiting low neutron-capture capability, able to withstand high temperatures, and resistant to irradiation damage (100–200 dpa\*), caused by a large high-energy neutron flux, and high burnups, around 100 GWd/tiHM (gigawatts–day per tonne initial heavy metal) at least. This quest for new performance levels is bound to have an impact on the nature, the composition, and geometry of the fuel, as of the fuel assembly, and on the choice of constituent materials.

Candidate fuels are set out in Table 10, ranged in order of increasing fissile material density, together with the associated values for some thermal properties, to allow comparisons.

Owing to the considerable experience gained with this type of reactor, and due to the relatively short leadtime allowed for, by the French Act of 2006 on sustainable radioactive material and waste management, as regards construction of a French prototype, the first Generation-IV fast reactor to be deployed industrially, in France, will probably be a sodium-cooled reactor (SFR), featuring an oxide-fuel core. Carbide fuel, owing to its thermal properties (this being a so-called “cool” fuel) is also being investigated, though this would be for a second-generation core. This fuel has likewise been selected for gas-cooled fast reactors (GFRs). Deployment of such reactors, however,

Table 10.

Characteristics of the various fuel materials being considered.				
Fuel materials	Oxide (U,Pu)O <sub>2</sub> *	Carbide (U,Pu)C*	Nitride (U,Pu)N*	Metal alloy U–Pu–Zr*
Theoretical heavy-atom density	9.7	12.9	13.5	14.1
Melting point (°C)	2 730	2 305	2 720**	1 070
Thermal conductivity at 1,000 °C*** (W/m·K)	2.1	12.8	13.5	17.5
Average thermal expansion coefficient 20 → 1,000 °C*** (10 <sup>-6</sup> /K)	12.5	12.4	10	17
Countries having operational feedback on the fuel, on the scale of a fast-reactor core	France, United States, United Kingdom, Germany, Russia, Japan	India, Russia	Russia****	United States, United Kingdom

\* For 20% Pu.

\*\* Partial decomposition may occur from 1,750 °C.

\*\*\* To 500 °C for U–Pu–Zr.

\*\*\*\* With enriched uranium only.

may only be effected once all of the major technological challenges raised by operation at very high temperatures have been met. Metal, and nitride fuels are, for the time being, held in abeyance. The former, owing to the issues raised by treatment of such fuels, using conventional processes; the latter, because of the requirement for a step of heavy nitrogen-15 enrichment, to restrict the yield of carbon-14 in the course of in-reactor dwell time.

## Sodium-cooled fast reactor fuel

Reference operating parameters, for a Generation-IV SFR reactor, are summed up in Table 11, below.

Table 11.

Main SFR reactor parameters.	
Reactor parameters	Reference
Boiler thermal power	3,600 MWth
Outlet temperature	530–550 °C
Energy conversion efficiency	40%
Coolant pressure	~ several bars
Fuel	U–Pu(–MA) oxide, or carbide
Cladding material	Austenitic steels, ferritic ODSs
Average burnup	~100 GWd/tiHM
Average power density	230 MWth/m <sup>3</sup>

Initially, the plan is to carry over the fuel design used for the Phénix and Superphénix fast reactors, i.e. (U,Pu)O<sub>2</sub> mixed-oxide **pellets\*** [ultimately, this fissile material may undergo evolution, to a (U,Pu)C carbide form]. The pellets are inserted into a cladding tube, made of ferritic–martensitic stainless steel. A spacer wire, made of similar-grade steel, is wound, and welded, around the tube’s outer surface, to ensure adequate clearance between pins, to allow coolant circulation (see Fig. 83).

The (U,Pu)O<sub>2</sub> mixed oxide is fabricated by way of oxalic co-conversion. Pu content is then adjusted, to 18–20% Pu, by diluting the oxide with UO<sub>2</sub>, following which the blended powders are pressed into shape, in the form of small cylinders, and sintered. Fuels incorporating minor actinides, whether used in the driver core [(U<sub>0.76–0.79</sub>Pu<sub>0.19</sub>Np<sub>0.0125–0.025</sub>Am<sub>0.0125–0.025</sub>Cm<sub>0.0008–0.0015</sub>)O<sub>2</sub>], or in blankets [(U<sub>0.9–0.6</sub>Np<sub>0.05–0.2</sub>Am<sub>0.05–0.2</sub>Cm<sub>0.0025–0.01</sub>)O<sub>2</sub>], are fabricated in the same manner.

Fuel pins are subsequently assembled into bundles, held in a martensitic-steel hexagonal tube, to ensure in-core mechanical strength for the pin bundles (see Fig. 84). The (U,Pu)O<sub>2</sub>/cladding steel/hexagonal tube and end-fittings mass ratio stands at about 1/0.8/1, respectively.

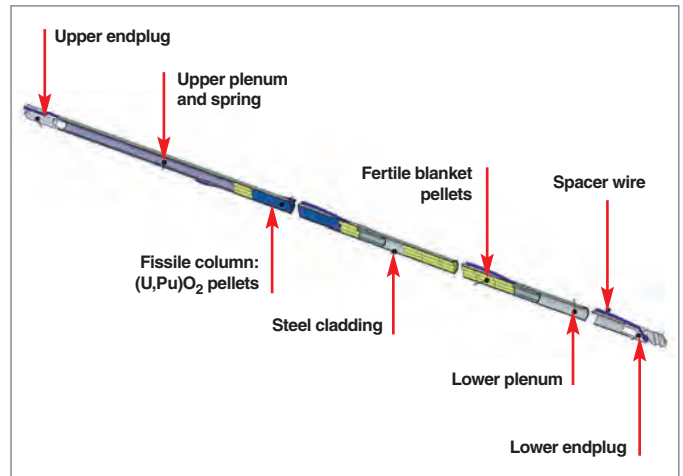

Fig. 83. Exploded view of an SFR fuel pin, showing its main components.

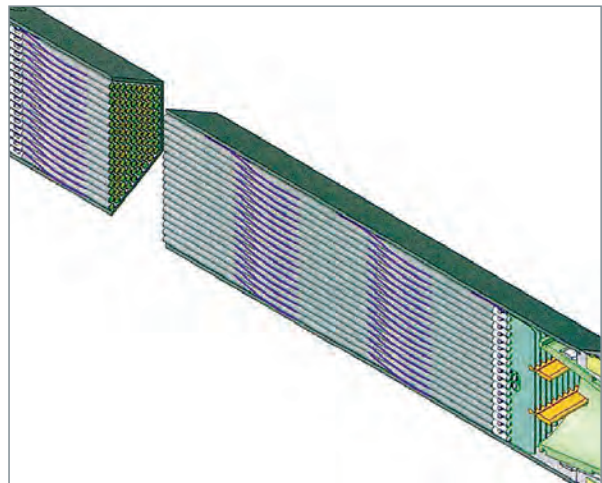

Fig. 84. Exploded view of the central region of a 217-pin Phénix fuel assembly.

## Gas-cooled fast reactor fuel

The GFR reactor is a helium-cooled fast-neutron reactor. Reference operating parameters are summed up in Table 12, below.

In order to withstand high temperatures (helium core outlet temperature reaching some 900 °C), all fuel element and assembly components are made of ceramic materials: (U,Pu)C, whether incorporating minor actinides or otherwise, for the fissile phase; and silicon carbide as constituent material for the cladding, and assembly.

The fuel element selected as reference takes the form of a flat, macrostructured plate, forming a hexagonal-cell honeycomb, each cell being occupied by a (U,Pu)C pellet, enriched to around 18–20% Pu, the structure being made up of a

Table 12.

Main GFR reactor parameters.	
Reactor parameters	Reference
Reactor power	2,400 MWth
Energy conversion efficiency	48%
Coolant inlet/outlet temperature	490/850 °C
Pressure	70 bars
Average power density	100 MWth/m <sup>3</sup>
Fuel	U–Pu(–MA) carbide
Reference fuel composition	(U <sub>0.80</sub> Pu <sub>0.20</sub> )C/SiC (50/50 vol.%)
Cladding material	SiC–SiC-fiber composite
Fuel/gas/SiC volume fraction	50/40/10%
Average burnup	50 GWd/tiHM

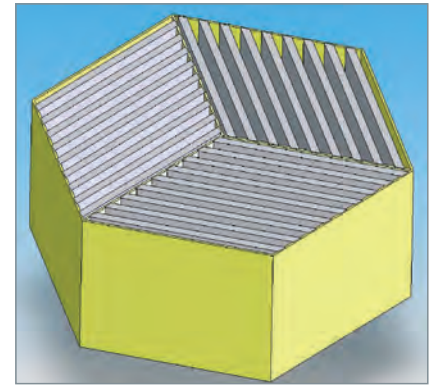

Fig. 86. Cutaway view of a GFR hexagonal fuel assembly.

small thickness of silicon carbide-based reinforced composite, positioned and assembled on either side of the cell array (see Fig. 85).

Plate elements are subsequently positioned vertically, in rhomboid stacks, to form an assembly (see Fig. 86). The assembly's hexagonal geometry makes it possible to ensure optimum stability, and mechanical equilibrium for the core. Helium circulates in the rectangular channels between the plates. Target (U,Pu)C/SiC mass ratio is close to 9/1.

One major difficulty is that of fabricating a SiC composite material impervious to fission gases, and volatile FPs: inserting a metallic liner would seem indispensable, to ensure this function. A fallback solution is being investigated: use of a refractory molybdenum-, niobium- or vanadium-based metal alloy.

Another fuel design is being investigated. This would differ chiefly in terms of its shape, switching from the plate type to a pin-type fuel (see Fig. 87). Nevertheless, the constituent materials for the fissile phase (actinide carbide) and cladding (SiC composite) are retained.

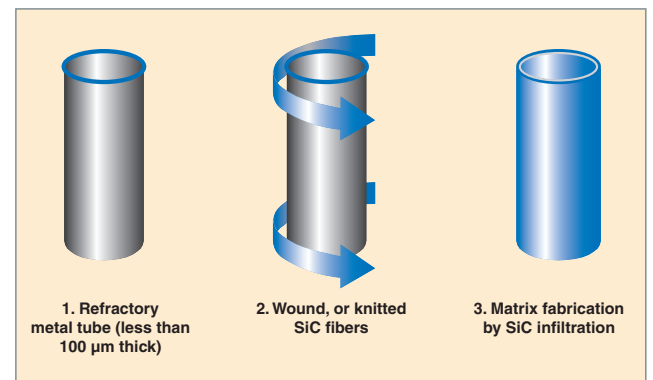

Fig. 87. SiC-fibrous SiC composite cladding concept, featuring an internal metallic liner, for a pin-type fuel suited for GFR use.

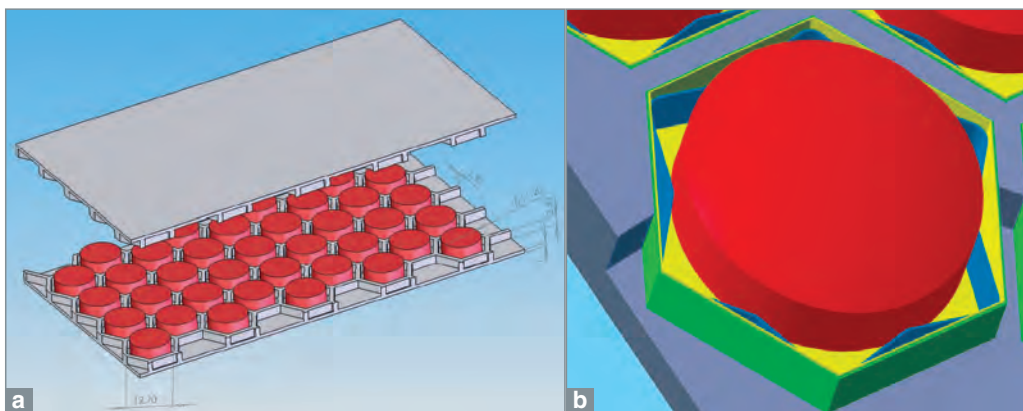

Fig. 85. (a) Exploded view of a GFR macrostructured fuel plate; (b) detail view of a cell.

## Very-high-temperature reactor (VHTR) fuel

The VHTR reactor is a helium-cooled, thermal-neutron reactor. This electric power-generating reactor may equally be dedicated to hydrogen production. Reference operating parameters are summed up in Table 13, below.

Table 13.

Main VHTR reactor parameters.	
Reactor parameters	Reference
Reactor power	600 MWth
Coolant inlet/outlet temperature	640/1,000 °C
Coolant pressure	70 bars
Average power density	6–10 MWth/m <sup>3</sup>
Fuel	Oxide, oxycarbide
Cladding material	TRISO layers (pyrocarbon/SiC or ZrC)
Average burnup	> 100 GWd/tiHM
Energy conversion efficiency	> 50%

This fuel is designed to withstand very high burnups, close to 500 GWd/tiHM, resulting in consumption of a large fraction of the initially present fissile material, along with such material as is yielded by neutron captures in uranium, or thorium. The fuel thus comes in the form of spherical particles, a few hundred microns in diameter, comprising uranium oxide (UO<sub>2</sub>) kernels – or possibly uranium carbide (UC), or oxycarbide (UCO) kernels, involving enrichment to less than 20%; or even kernels also containing plutonium [(U,Pu)O<sub>2</sub>, or 100% PuO<sub>2</sub>] – coated with dense pyrocarbon (PyC) and silicon carbide (SiC) ceramic layers. A cutaway view of a TRISO particle is shown in Figure 88.

The particles are subsequently mixed with graphite powder, and assembled by compaction into compacts (small rods, about 5 cm long, and 1 cm in diameter, for reactors of the Gas-Turbine Modular Helium Reactor [GT-MHR] type), or pebbles, about 6 cm in diameter (for Pebble-Bed Modular Reactor [PBMR]-type reactors). A picture of fuel elements, thus fabricated, is shown in Figure 89.

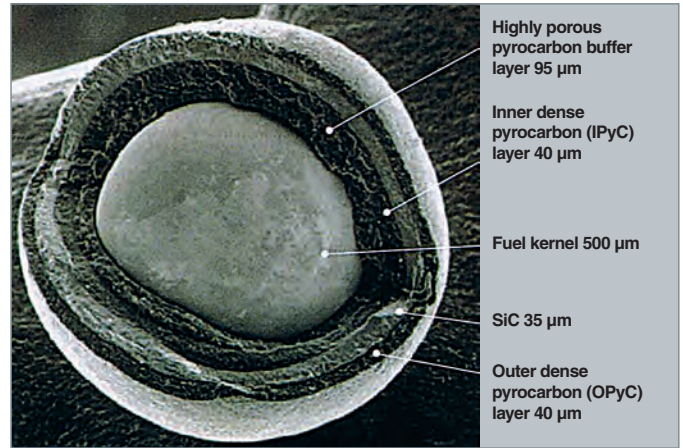

Fig. 88. Fractograph of a UO<sub>2</sub>-TRISO-SiC particle.

Mass composition for particles, compacts, and standard fuel elements (prismatic blocks), as used in a UO<sub>2</sub> GT-MHR reactor, is set out below, for reference purposes (see Table 14).

As regards the fuel elements, it should be noted that the structural materials/UO<sub>2</sub> mass ratio stands close to 24, i.e. some 80 times larger than that for EPR fuel, for instance.

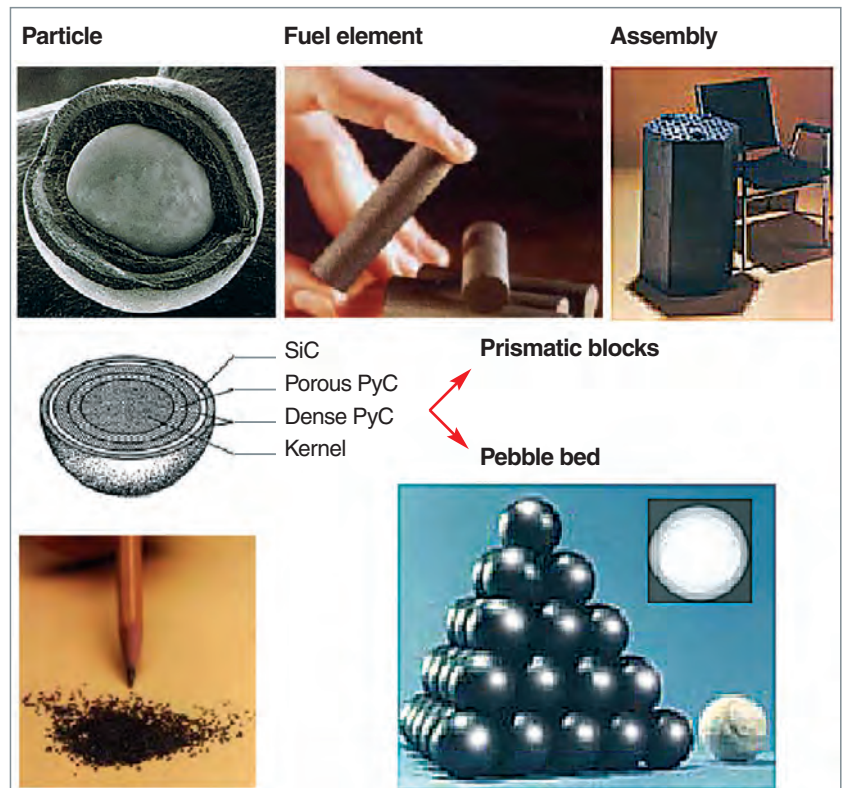

Fig. 89. View of VHTR fuel elements.

Table 14.

Approximate elemental composition of a UO <sub>2</sub> GT-MHR standard fuel element (prismatic block).										
	Standard element			Compacts			Particles			
	Mass		Volume	Mass		Volume	Mass		Volume	
Constituents	(kg)	(%)	(L)	(kg)	(%)	(L)	(kg)	(%)	(L)	(%)
Graphite	87	69	89.8							
Resin-impregnated carbon	29	23		29	73	19				
Porous carbon	0.9	0.1		0.9	2		0.9	8	0.9	26
Pyrocarbon	2.6	2		2.6	7		2.6	24	1.4	40
SiC	2	2		2	5		2	19	0.7	20
UO <sub>2</sub> *	5.3	4		5.3	13		5.3	49	0.5	14
<b>Total</b>	<b>126.8</b>	<b>100</b>	<b>89.8</b>	<b>39.8</b>	<b>100</b>	<b>19</b>	<b>10.8</b>	<b>100</b>	<b>3.5</b>	<b>100</b>

\* Compact packing density, by volume, with UO<sub>2</sub> particles: ~ 18%.

## Characteristics of fuels incorporating minor actinides

Incorporation, into fuel, of minor actinides, americium and curium in particular, whether in homogenous mode (driver core fuel), or heterogeneous mode (minor actinide-bearing blankets) induces, as these come into contact with the fuel assemblies, owing to the intense  $\alpha$  radiation and neutron emissions involved [spontaneous decay, and ( $\alpha$ , n) reactions in oxygen], high neutron fluence rates, and thermal power outputs. By way of example, thermal power released by such fuels, three years after being discharged from a reactor, is about three times higher than for standard fuels. Such specific char-

acteristics should entail, as regards fresh fuels, from fabrication to the time they are loaded into a reactor, adopting provisions similar to those for irradiated fuels, to wit forced-ventilation cooling during transport, and handling such assemblies behind thicknesses of biological protections (see the chapter on "Fuel refabrication", for minor actinide-bearing fuels, pp. 141–146).

**Nathalie CHAUVIN, Michel PELLETIER, Alain RAVENET  
and Jean-Michel ESCLEINE,**  
*Fuel Research Department*





## Treatment of advanced fuels: head-end processes

Spent fuel treatment begins with a mechanical treatment, allowing the cladding to be disrupted, thus making it possible to access the fuel material itself, in order to dissolve it. In some cases, it may be useful to separate the cladding materials prior to the dissolution step, to limit the amounts of solids entering the dissolver.

### Breakup of metal-clad fuels

The fuel concept currently being investigated for the sodium-cooled fast reactor (SFR) comprises a pellet stack, held in a ferritic–martensitic stainless-steel cladding tube, fitted, around its outer surface, with a spacer wire, wound and welded round the tube. Fuel pins (some 200–300) are then assembled into a bundle, held in a martensitic-steel hexagonal tube. A number of techniques have been developed, and used on a pilot

scale, as regards mechanical treatment of such fuels: radially slicing open, by means of a saw, abrasive wheel, or milling cutter, the hexagonal tube, as shown in Figure 90; or cutting it axially, along one edge; removal of the spacer wire, and extraction of the pins (see Fig. 91), which are then sheared, singly (see Fig. 92), or in small bundles. The latter technique has resulted in frequent shear holdups, owing to a “bunching” of spacer wires, obstructing the mechanical cutting system.

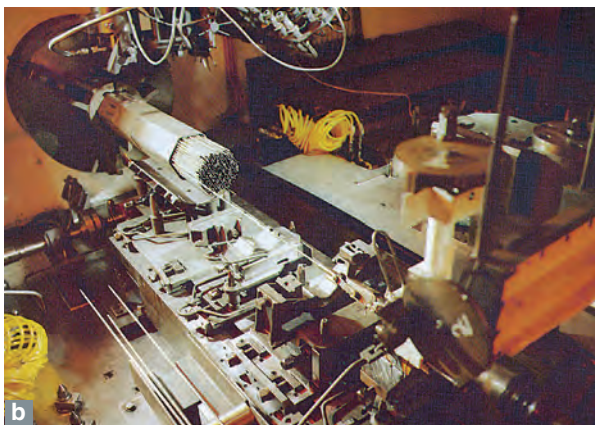
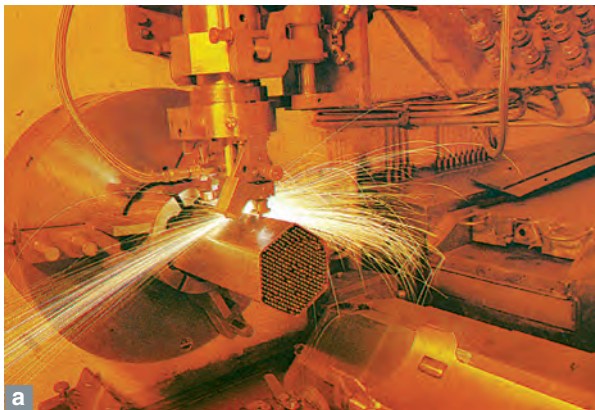

Fig. 90. (a) Abrasive cutting of a hexagonal tube. (b) Mechanical extraction of single pins from the truncated tube.

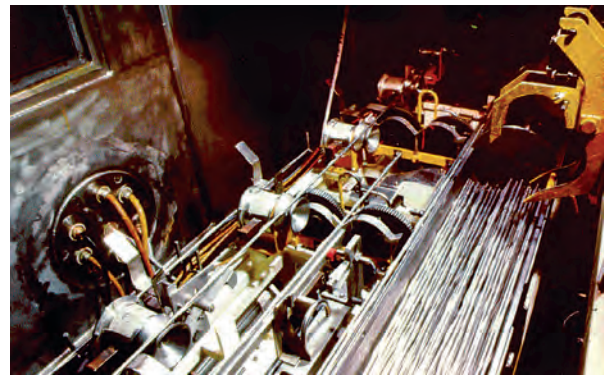

Fig. 91. “Unit dispenser,” used for the extraction of single pins, to subject them to shearing (Marcoule Pilot Workshop [APM]).

To sum up, this experience shows that techniques are already available, that are proven at the pilot scale. These techniques must be extrapolated to the industrial scale, while avoiding the pitfalls experienced (mechanical seizure, plugging of fuel segments when sheared...), if possible while doing away, at the same time, with intermediate steps, such as spacer wire stripping; and carrying out the shearing operation on pin bundles, rather than on single pins, to adjust cutting capacity to dissolver load capacity. Mechanical shearing may be used with any metal cladding, object shape (tubes, plates) only having an incidence in terms of the shape of the cutting tool. As regards gas-cooled fast reactor (GFR) fuel of the plate type, punching techniques may also be considered, as developed for the treatment of research reactor fuels. A cutaway view of a punching machine is shown in Figure 93. The plates, positioned horizontally on a thrustor device, are inserted into the loading sleeve of the punching machine. Vertical punching dies, actuated by a pneumatic cylinder, gradually “nibble up” the plate. A casing placed under the cutting area receives the fuel, and cladding fragments.

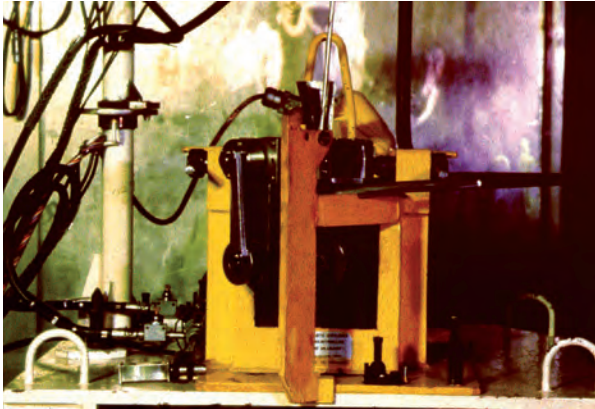

Fig. 92. Shearing single pins (Marcoule Pilot Workshop [APM]).

Carbide fuels involve a **pyrophoricity\*** risk, calling for special safety measures: mechanical treatment of this type of fuel would require thorough inerting of the entire shearing system, down to fuel transfer to the dissolver.

### Breakup of ceramic composite-clad fuels

Solid bodies exposed to energies of several kilojoules, generated by high-voltage pulses of around 200–500 kV, involving discharge currents of 10–20 kA, undergo locally, over a few microseconds, energy density transfers of 10–100 J/cm. This energy input causes local rises in temperature that may reach

10,000 K, and pressures of around  $10^{10}$  Pa, instantly shattering the solid, reducing it to the state of debris, of varying fineness. The principle of this pulsed-current fragmentation technique is set out in Figure 94.

This technique was used, on an exploratory basis, on inert components, representative however of VHTR and GFR fuel element components, in particular on a silicon-carbide composite, honeycomb-cell macrostructured plate, and on TRISO particles featuring  $ZrO_2$  kernels. Pictures of the state of these objects, subsequent to the pulse, are shown in Figures 95, and 96.

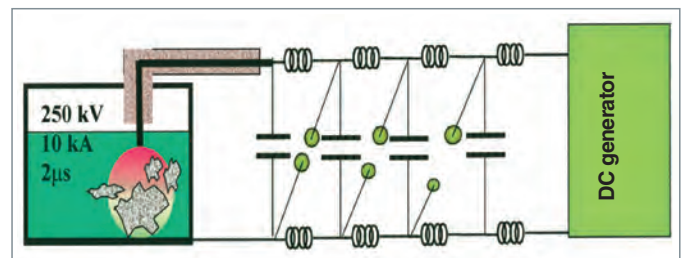

Fig. 94. Principle of pulsed-current breakup.

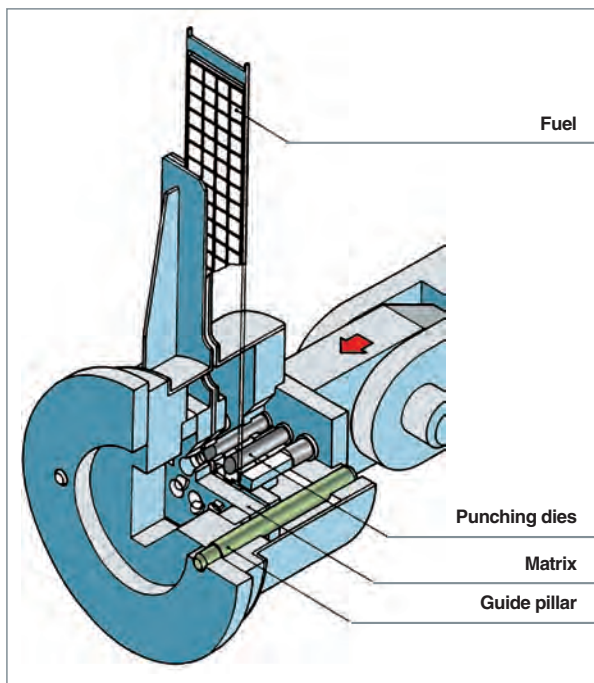

Fig. 93. Cutaway view of a fuel plate punching machine.



Fig. 95. View of a SiC honeycomb-cell macrostructured plate, prior to pulsed-current treatment (a), and after 1 pulse (b).

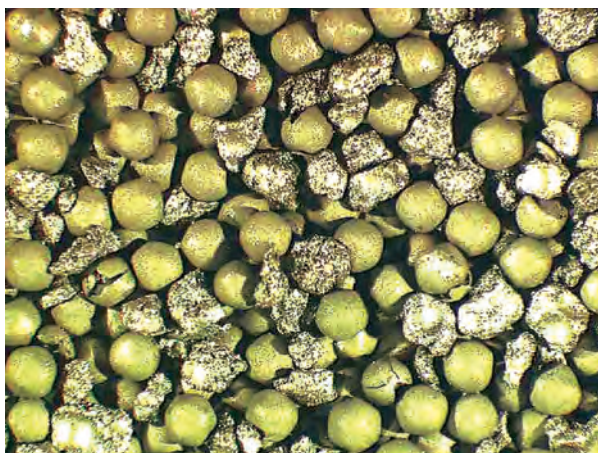

Fig. 96. View of VHTR fuel particles, featuring  $ZrO_2$  kernels coated with pyrocarbon and SiC layers, subsequent to pulsed-current treatment (1 pulse).

Other techniques are also being investigated, such as crushing, and techniques for the separation of the fissile compound from ceramic structural materials, chiefly by drawing on the differences in density. Be that as it may, the pulsed-current fragmentation technique does stand as the most promising one, as regards the breakup of ceramic claddings, and a test bed is currently being brought to nuclear environment standards, for forthcoming tests involving uranium.

## Dissolution of advanced fuels

Once the cladding has been broken up, dissolution of the fuel ceramic itself may be carried out. If the fuel involved is oxide-based, operations will be similar to those carried out in the La Hague (France) workshops, for the dissolution of UOX and MOX fuels from current water reactors. For fuels of the carbide type, nitric acid dissolution is also being considered. Differences mainly concern the formation of organic compounds (see the Box on “Dissolution of carbide-type fuels”).

**Michel MASSON,**  
*Radiochemistry and Processes Department,*  
**Vincent ROYET and Alain BÉZIAT,**  
*Fuel-Cycle Technology Department*

### Dissolution of carbide-type fuels

Carbide-type fuels are, in like manner to oxide fuels, soluble in hot, concentrated nitric acid, in accordance with the following principal theoretical dissolution reactions:

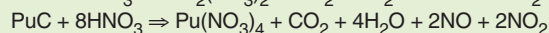
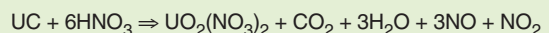

For a fuel featuring 20% Pu content, allowing for a nitrous-vapor recombination rate of around 90%, dissolution of one mole (U,Pu)C consumes, as is the case for an oxide fuel, some 3 moles nitric acid.

Carbides dissolve rapidly at nitric acidities higher than 1 N. Optimum dissolution conditions, for carbide fuels, occur for 8 M  $HNO_3$ , at 80 °C, and, as regards mixed U–Pu carbides, dissolution is congruent (i.e. the Pu/U ratio stays virtually constant throughout dissolution). At such acidities, and at that temperature, dissolution rates stand at around  $30 \text{ mg}\cdot\text{cm}^{-2}\cdot\text{min}^{-1}$ .

The dissolution of carbide-type fuels yields quantities of dissolution residues comparable to those for oxide fuels. The quantities of recovered dissolution residues, involving masses in the 5–10 kg/tiHM range, for an envisaged burnup of 6.6% FIMA, are comparable, in every respect, to what is commonly measured with oxide fuels.

Dissolution solutions exhibit strong coloring (with a red-brown hue), as shown in Figure 97, this phenomenon being generally accounted for by the formation of complexes involving metal ions and organic compounds. During dissolution, a major fraction of the carbon released (up to 50%, in some cases) is found to be solubilized, in the form of carboxylic acids (in particular, oxalic, formic, and acetic acids), along with aromatic compounds featuring phenolic and carboxylic functions, which may interfere with the partitioning of plutonium by TBP.



Fig. 97. Dissolution solution yielded by dissolution of uranium carbide by concentrated nitric acid at boiling point, with final composition:  $[U] = 50 \text{ g/l}$ ,  $[HNO_3] = 5 \text{ M}$ .



# Hydrometallurgical processes for the fuel cycles of the future

## Introduction

### Historical overview

Direction 1, as set out by the French Act on radioactive waste management research – as passed by the French Parliament, and enacted on 30 December 1991 – concerned as it was with long-lived, high-level waste, called for the investigation of “partitioning, and transmutation of the long-lived radioactive elements present in such waste.”

The aim was to evaluate the feasibility, on the one hand, and potential benefit, on the other hand, of a specific, differentiated management mode, with regard to certain long-lived radionuclides, present in so-called “spent” fuel, and currently left inside vitrified waste (see Table 15). These radionuclides, indeed, owing to their long radioactive half-lives, stand, after plutonium, as the chief long-term contributors to spent fuel potential radiotoxicity, and keeping them out of glass packages, with a view to their transmutation into stable nuclides, or shorter-lived radionuclides, could allow less stringent disposal constraints to be called for.

An extensive research program, going under the acronym SPIN (Separation Incineration), was set in train, under the aegis of CEA, in the early 1990s.

Aside from uranium, and plutonium, which were already being recovered, by way of the PUREX process, the aim was to propose solutions for the separation of certain long-lived radionuclides (Np, Am, Cm, Cs, I, Tc), deemed to be the chief long-term contributors to the radiotoxicity of glass packages designated for deep disposal. This is what became known as “enhanced partitioning.”

### Which elements should be partitioned?

Plutonium stands as the chief contributor to spent fuel radiotoxic inventory. Setting in place a partitioning and transmutation (P&T) strategy, with respect to long-lived radionuclides, entails, as a prerequisite, that a plutonium management strategy be implemented: in-reactor recycling of plutonium is, in effect, the first step that must be effected, if the partitioning–transmutation of the other elements contributing to waste toxicity is to make any sense.

Once plutonium has been partitioned, minor actinides – americium first and foremost, followed by curium, and neptunium – yield the most significant contribution to the spent fuel’s radiotoxic inventory (see Fig. 98). They thus stand out as the radioelements it is indispensable to prioritize, in terms of management involving partitioning and transmutation, if waste long-term radiotoxic inventory is to be usefully, and effectively reduced. For that reason, they have stood at the core of the

Table 15.

Characteristics of long-lived radionuclides contained in a spent fuel assembly, discharged at 60 GWd/t.				
Nature	Radionuclides	Half-life (years)	Quantity (g per tonne initial uranium)	Isotopic fraction (%)
Minor actinides*	Neptunium-237	2 140,000	916	100
	Americium-241	432	490	62.4
	Americium-243	7,380	294	37.4
	Curium-245	8,530	11	8
Fission products*	Selenium-79	1 100,000	8	8
	Zirconium-93	1 500,000	1 250	24
	Technetium-99	210,000	1 410	100
	Iodine-129	15 000,000	308	82
	Cesium-135	2 300,000	769	17
Activation products* in impurities	Chlorine-36	301,000	2	8
Structural activation products*	Zirconium-93	1 500,000	81	0.04
	Niobium-94	20,300	2	0.4

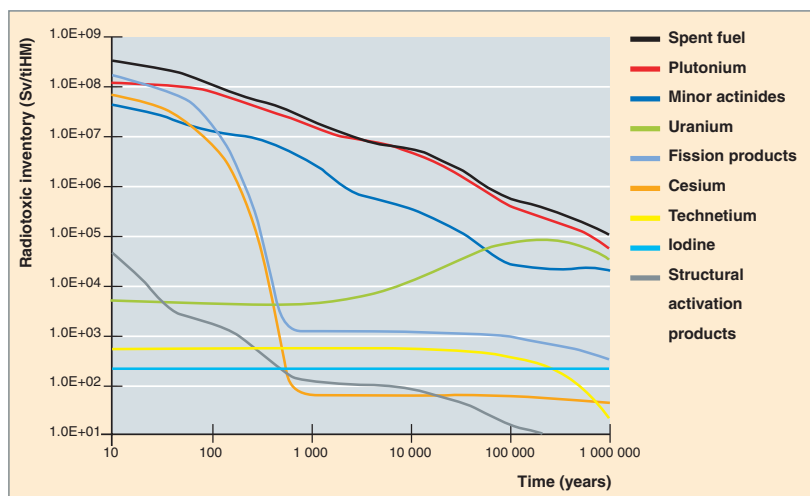

Fig. 98. Evolution of the radiotoxic inventory, expressed in sieverts\* per tonne initial heavy metal (uranium) (Sv/tiHM), in spent UOX fuel discharged at 60 GWd/tiHM burnup.

investigations conducted on partitioning–transmutation. After the first 100 years or so, fission products no longer make anything more than a marginal contribution to spent fuel radiotoxicity. However, initial studies modeling behavior in geological disposal conditions have shown that, after several hundreds of thousand years, it would initially be certain fission products – in particular iodine-129, cesium-135, and technetium-99 – that would reach the biosphere, owing to the specific physical and chemical properties they exhibit, such as high water-solubility. These fission products have thus also been considered, as part of a partitioning and transmutation strategy. On the other hand, advances in research on disposal have allowed certain contributions to be more precisely gauged. Thus, more recent studies, concerned with disposal scenarios in clay conditions, have confirmed the mobility of iodine, though no such mobility for cesium, or technetium. Chlorine-36 has also been singled out as being potentially mobile. However, owing to the small quantities found in spent fuel (about 1,000 times lower than those involved for the aforementioned fission products), this nuclide has not been retained for the purposes of partitioning–transmutation studies.

On these grounds, the six following radionuclides have thus been selected, as the elements to be targeted by investigations on partitioning and transmutation: americium, curium, neptunium, iodine, cesium, and technetium.

### The choice of hydrometallurgy as reference pathway

The deadlines set, fairly close as they are, all things considered, for programs on long-lived waste management (first 2006, in the Act of 30 December 1991; and subsequently 2012, as per the Act of 2006), led to giving pride of place, for the purposes of minor actinide partitioning, to processes involving no discontinuity with the PUREX solvent extraction-

based process. Indeed, this type of process, and the technologies involved in its operation are particularly well suited to a nuclear environment.

Consequently, the research strategy decided on involved:

- putting to advantage the potentialities of the PUREX process, for the purposes of partitioning neptunium, iodine, and technetium;
- designing, and developing complementary separation steps, involving the use of novel molecules, for the extraction of elements of interest, such as americium, curium, and cesium, from the PUREX raffinate;

- evaluating the potential of other technologies, involving a break with solvent extraction, chiefly pyrometallurgical processes.

### What are the concrete targets involved, in terms of performance?

Depending on the elements considered, target recovery rates vary:

- 99.9%, as regards americium, curium, and neptunium. Indeed, leaving just 0.1% of these elements inside glasses would allow a significant gain in terms of potential radiotoxicity for such ultimate waste, designated for disposal (by a factor of about 100). Such rates do appear to be achievable, when referred to performance levels at the La Hague (France) plants, as regards uranium and plutonium recovery. It should be noted that, with respect to neptunium, managed as this is by way of an adaptation of the PUREX process, a recovery rate higher than 99% has been set, bearing in mind that any remaining traces of neptunium would be extracted by the complementary processes, developed for the recovery of americium, and curium;
- as regards the three fission products, the aim was to achieve the best recovery rate feasible.

With regard to americium, and curium, not readily separated as these are, on the one hand, from lanthanides, or, on the other hand, from each other, performance levels have further been set in terms of decontamination:

- with reference to reactor, and fuel research, the mass of lanthanides must amount to less than 5%, in the (Am + Cm) fraction;

- with regard to the individually separated minor actinides, Am and Cm, a residual fraction has been set at 1% curium in americium, as, conversely, for the Am fraction remaining in Cm.

---

### ***What were the main stages involved in the “hydrometallurgy” program conducted under the French Act of 1991?***

Consistent with the 2006 deadline, research work fell into two main phases:

- an exploratory phase, lasting 10 years or so, carried out in a broad, cooperative context, during which many extractant systems were evaluated, chiefly with regard to the most difficult step, namely actinide–lanthanide separation;
- a “demonstration” phase, from 2002 to 2005, during which investigations were refocused, on the processes deemed to be the most promising, for which so-called “demonstration” tests were carried out,

the goal being to provide demonstrations of:

- scientific feasibility (validation of the basic concepts involved in the separations), by the end of 2001;
- technical feasibility (testing, and global validation of the processes), by 2005.

Over the second phase (2002–2005), research work was chiefly concerned with:

- flowsheet consolidation;
- the evaluation of process implementation in equipment analogous to industrial contactors, and, if required, adjustment of the flowsheets involved;
- the development of treatment processes for the solvent, for recycling purposes; and evaluation, over the long term, in conditions as representative as possible of industrial operations, of the effectiveness of such treatment, in an irradiation loop.

Completion of this second phase involved, during 2005, carrying out experiments on a larger scale (involving a batch of 15 kg fuel discharged from a reactor in the French fleet), and in conditions more representative of industrial operations, in particular in terms of technology, through the use of small-diameter pulsed columns.

---

### ***From the Act of 1991 to the Act of 2006: enhanced partitioning, group partitioning***

The 15 years of investigations, carried out under the Act of 1991, involved a major research effort; considerable advances, as recognized, in particular, by a group of experts commissioned by the French Government, were achieved. One major achievement was the recovery of minor actinides (neptunium

together with plutonium, on the one hand; americium and curium, on the other), on the scale of several kilograms spent fuel.

Under the new French Act, setting a program for sustainable radioactive material and waste management, as promulgated on 28 June 2006, partitioning and transmutation studies are now to be carried out in close connection with research on Generation-IV systems. All that has been achieved, with the research work on enhanced partitioning, stemming from the Act of 1991, will now contribute to the development of separation processes, for the purposes of minor actinide recycling in heterogeneous mode. Investigations are chiefly concerned with simplifying, and optimizing the DIAMEX and SANEX processes, e.g. by combining them into a single cycle.

Concurrently, the option of actinide transmutation in homogeneous mode, across the entire future fast-reactor fleet, is also being investigated. As regards the partitioning part, this concept, going under the name GANEX (Group Actinide [An] Extraction), is, here again, based on liquid–liquid extraction, thus drawing on industrial experience with PUREX, and the findings from enhanced partitioning.

---

### ***Advantages, and technological aspects of enhanced partitioning***

The concept of group, closed-cycle actinide management is associated to the treatment of fuels yielded by fourth-generation reactors. This complies with the sustainability criterion, which these systems are intended to meet:

- the fuel’s fissile material chiefly consists of plutonium, and, in smaller amounts, americium. This leads to savings on cycle costs, as a result of doing away with uranium enrichment, and improved utilization of the latter element;
- actinide inventory, within the fuel cycle, is kept under control, and regulated by way of the yield–consumption of Pu, Np, Am, Cm in the reactors;
- minor actinides are managed along with the fuel, rather than with ultimate waste, to be consigned to deep disposal.

At the same time, such a cycle presents the best features, in terms of proliferation resistance. Indeed, regardless of which point is considered, in the treatment and fabrication cycle, plutonium never occurs in separated form, always being combined with uranium, and other actinides (inherent chemical, and radiological barrier).

One further advantage is relative flexibility, in terms of adjustment, allowing the treatment, with no major modification involved, of a multiplicity of fuels (for reactors of the UOX/MOX PWR type, or MOX fast reactors, or research reactor fuels).

In this context, a strategy was put in place, to develop a process for the group partitioning of actinides, as a crosscutting operation with respect to spent fuel treatment for gas-cooled fast reactors (GFRs), and sodium-cooled fast reactors (SFRs). Thus, the targets set for the GANEX process, aside from compactness, and yielding just one type of waste (glass packages), aside from structural waste, involve, as in the enhanced partitioning case, an actinide recovery rate of 99.9%, with minimum purity, with respect to lanthanides, set at 5% for the actinide stream. As regards gas-cooled fast reactors (GFRs), the requirement that, at beginning of life, two actinide rings should be available, involving different U/actinide enrichments, for the inner, and outer rings, entails, as regards the cycle, a partial uranium pre-separation step, at the head end, to allow subsequent adjustments to be made to the uranium streams, to achieve the desired contents, in the co-conversion and fabrication steps that follow. Which is why the GANEX process involves:

- a selective uranium separation step, at the head end of the process;
- group extraction of the other actinides (Pu, Np, Am, Cm).

## Neptunium partitioning

### Neptunium separation goals, and principle

In the operating conditions currently prevailing at the La Hague plants, 25% of the neptunium contained in treated fuel is left in the fission product raffinates, designated for disposal, after vitrification. The remaining fraction follows the uranium production stream; this undergoes separation in the second purification cycle (see the Box “Neptunium behavior in the PUREX process”, below). The aim pursued is to improve neptunium extraction efficiency, in the first cycle, so that the quantities of neptunium occurring in the fission product raffinates are no more than 1% of the neptunium contained in the fuel treated. An adaptation of the first purification cycle flowsheet, as featured in the PUREX process, requiring no alteration to the layout of current industrial workshops, was sought, to allow these workshops to carry out this separation.

### Modification of the PUREX process to cater for quantitative neptunium extraction

Within the fuel dissolution solution, neptunium occurs in oxidation states +V, and +VI, in accordance with the following redox equilibrium:

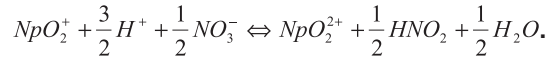

During the extraction operation, this equilibrium is shifted to promote formation of neptunium(VI), since both products of this reaction, Np(VI) and nitrous acid, are extracted by the organic phase. Neptunium extraction efficiency, in this operation, is thus dependent on neptunium(V) oxidation kinetics, and this is all the faster, the higher the nitric acid concentration.

The principle selected, to achieve quantitative neptunium extraction, is to raise nitric acid concentration in the dissolution solution, to amplify, and speed up neptunium(V) oxidation, during the extraction operation:

#### Neptunium behavior in the PUREX process

Neptunium present in the dissolution solution is coextracted, together with uranium and plutonium, by TBP, in the extraction step. Selective plutonium stripping is then achieved through the reduction of plutonium(IV) to plutonium(III), by means of uranium(IV). During this operation, neptunium is reduced to oxidation state IV. In this form, it is extractable by TBP, and thus remains with the uranium, in the solvent phase (see Fig. 99). The neptunium is then stripped, along with uranium, in the following step.

Subsequent to the stripping step, the uranium stream undergoes concentration, prior to purification, in the uranium cycle. During this concentration operation, neptunium is oxidized to oxidation states V, and VI. Uranium–neptunium separation is effected in the second uranium purification cycle, a reducing scrub with hydrazine nitrate, carried out on the loaded solvent, serving to reduce neptunium(VI) to the (V) form. Being poorly extractable by the solvent in this form, the neptunium remains in the aqueous phase, ending up in that cycle’s extraction raffinates.

According to operational findings from the La Hague plants, 75% of the neptunium is found in the first purification cycle’s production stream, more than 99.8% of this fraction being recovered, and sent out in the extraction raffinates from the uranium purification cycle downstream.

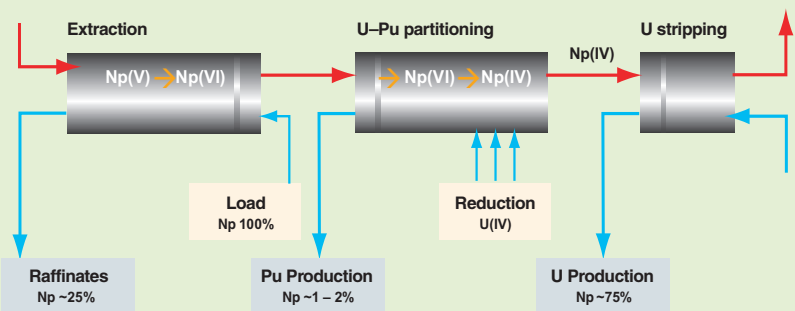

Fig. 99. Behavior of neptunium during the first cycle in the PUREX process.



- this was initially validated in tests carried out in a pilot facility, featuring small-diameter (27-mm) pulsed columns, 4 meters high, using a reconstituted uranium, plutonium, and neptunium solution, in accordance with a flowsheet close to that implemented in industrial workshops. More than 90% of the neptunium was thus extracted, by raising feed solution acidity from 3 M to 4 M, notwithstanding the short height of the pulsed columns. Indeed, industrial columns involve a working height twice that size, and much better performance may thus be anticipated;
- to demonstrate the technical feasibility of this separation, it was decided to carry out a test involving an actual solution, in the ATALANTE shielded process line, by completing a full purification cycle. To draw up the operating flowsheet for this test, a modeling approach was used, supported by appropriate experiments, as was the case for the flowsheets used in the extraction workshops at the La Hague plants.

On the basis of investigations on the kinetics of the Np(V)–Np(VI) redox system in a single-phase aqueous system, an initial set of kinetic laws was entered into the PAREX code (see the section on “Modeling the PUREX process. The PAREX code”, pp. 66–70). However, if the neptunium extraction efficiencies observed in flowsheet experiments, or in operational findings in plants are to be accounted for, a model yielding faster neptunium(V) oxidation kinetics will be required.

In a second, subsequent phase, measurements were carried out in conditions more representative of those found in a contactor stage, where the neptunium(VI) formed is removed from the aqueous phase (extraction to the solvent phase), even as it forms.

The findings from the kinetics study (see Fig. 100) showed that the neptunium(V) oxidation kinetics, as measured, is even faster than that computed using the kinetic model that had allowed the simulation of the extraction efficiencies observed in plant operations. As a conservative measure, the latter model was retained, to draw up the test flowsheet.

### The demonstration test carried out in the ATALANTE shielded process cell

Using the model selected, to represent oxidation–reduction reaction kinetics for the Np(V)–Np(VI) system, simulations carried out with the PAREX code show that increasing nitric acid concentration from 3 M to 4.5 M should allow a neptunium extraction efficiency higher than 99% to be achieved. The option of injecting additional nitrous acid, at the base of the extraction column, to speed up, as and when required, neptunium(V) oxidation, has been retained (see Fig. 101).

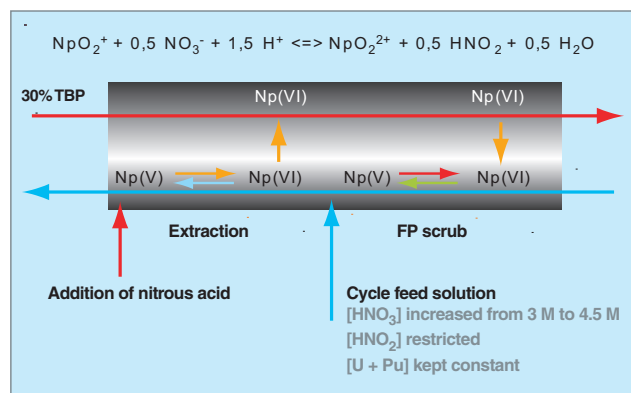

Fig. 101. The principles taken on board, to draw up the flowsheet ensuring near-quantitative extraction of neptunium.

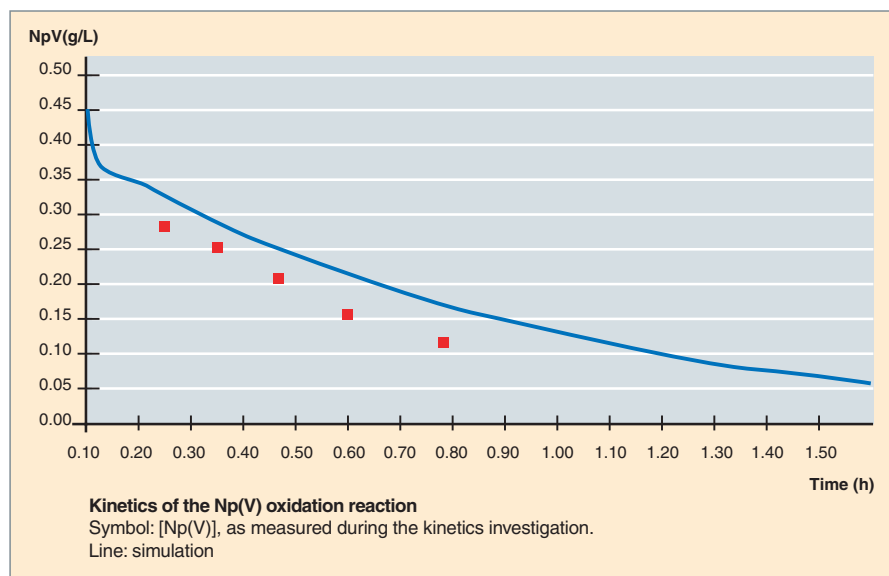

Fig. 100. Measurement of Np(V) oxidation kinetics.

On the basis of these findings, a batch of 15 kg UOX fuel, irradiated to 52 GWd/tiHM, and cooled for an average 6.5 years, was dissolved, to yield a “representative” solution, in order to carry out this test, in extractors involving the same technology as those operated in industrial workshops. A view of the shielded process line, along with a photograph of the pulsed columns used is shown in Figure 102.

The flowsheet for the extraction part of the test cycle (see Fig. 103), of the same type as that implemented in the first cycles at the La Hague plants, involved:

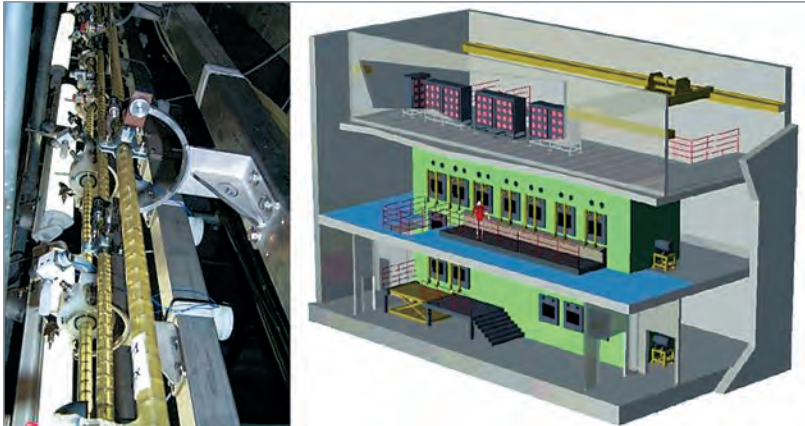

Fig. 102. Views of the ATALANTE shielded process cell, and its pulsed column equipment.

- two pulsed columns (PCs), 4 m high, and 15 mm in diameter, dedicated to the extraction function;
- one identical pulsed column, dedicated to the fission product scrubbing operation, in particular with regard to zirconium;
- one 8-stage mixer-settler (MS) cascade, for the technetium scrubbing function;
- one 4-stage mixer-settler cascade, for the complementary extraction function.

Measurements of neptunium concentrations in raffinates from the main, and complementary extractions found these were below analytical detection limits. Thus, the neptunium extraction efficiency achieved was higher than 99.6% (see Fig. 104).

The kinetic model developed for the Np(V)–Np(VI) redox system allowed the test to be modeled correctly, as evidenced by comparison between computations, and experimental findings (see Fig. 105). The similarities in behavior exhibited by neptunium, and uranium and plutonium show that neptunium does indeed occur in a form extractable by the organic phase, i.e. in oxidation state VI. The accurate simulation of the uranium and plutonium buildups observed further validates the model developed.

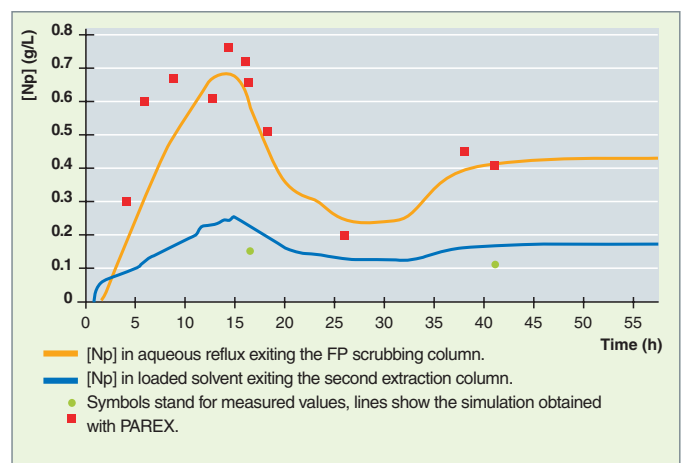

Fig. 104. Comparison between experimental neptunium extraction data, as yielded by the test carried out in the CBP line, and values computed using the PAREX simulation code.

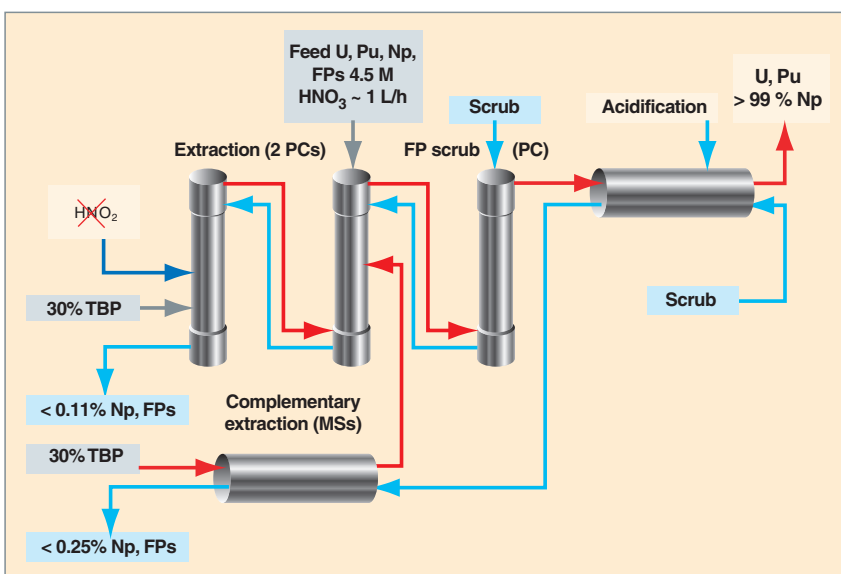

Fig. 103. Flowsheet for the neptunium extraction test, as carried out in the ATALANTE shielded process cell (CBP).

The modeling approach used, combined with suitable laboratory tests, made it possible to arrive at a very straightforward adaptation of the current PUREX process, to achieve near-quantitative neptunium extraction. This flowsheet was validated by treatment of a significant quantity of spent oxide fuel, using equipment of the same type as that operated in industrial workshops. Moreover, with the PAREX code, a choice instrument is available, for the purposes of transposing this flowsheet to the industrial scale.

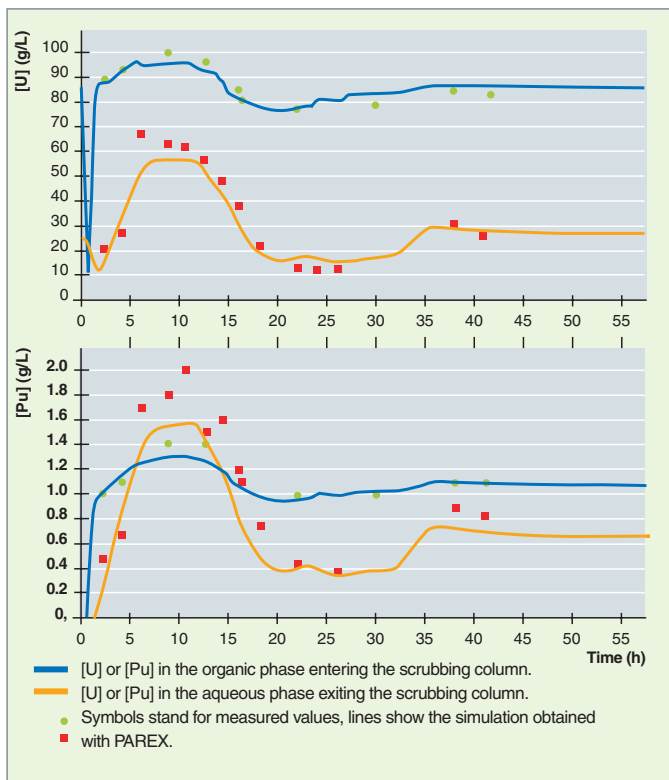

Fig. 105. Comparison between experimental uranium and plutonium extraction data, as yielded by the CBP test, and values computed using the PAREX simulation code.

## Technetium separation

In order to bring down the harmfulness of the waste designated for ultimate disposal, the aim is, as with neptunium, to increase technetium extraction efficiency, so that less than 1% of the technetium remains in extraction raffinates from the first cycle.

In the operating conditions currently prevailing in the La Hague plants, technetium extraction efficiency is higher than 95%. Opting for a higher nitric acid concentration in the feed solution (4.5 M, rather than 3 M), as considered for the processes of the future, results in exacerbating Zr buildup, during the extraction operation, and, according to findings from simulations using the PAREX code, improved technetium extraction (coextraction of technetium and zirconium). Analysis of the technetium occurring in the main extraction raffinate showed that technetium concentration, for this stream, lies below the quantification limit, i.e. 0.6 mg/l for this element, corresponding to 0.5% of the incoming technetium flow.

The flowsheet operated thus allows extraction of more than 99% of the technetium contained in the cycle's feed solution.

## Current management of technetium in the first cycle of the PUREX process

Technetium occurs in the form of pertechnetetic acid ( $\text{HTcO}_4$ ) in the dissolution solution. By substituting for a nitrate ion, in extracted neutral metal complexes, technetium may be coextracted, along with the metal cations, in accordance with the following reactions:

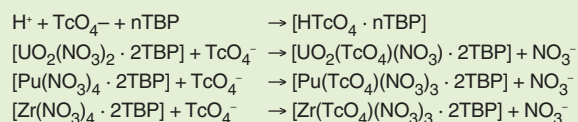

This coextraction phenomenon is at its most marked with zirconium. In the extraction operation, technetium is coextracted with zirconium in the initial stages involved in the operation, thus rising up to the uranium- and plutonium-rich stages, where zirconium is stripped to the aqueous phase. Overall, a buildup of zirconium is thus found to occur, in the stages where the solvent uranium load is low. Zirconium is ultimately recovered in the raffinates, while technetium, having the ability to undergo coextraction with uranium, and plutonium, remains in the solvent phase (see Fig. 106).

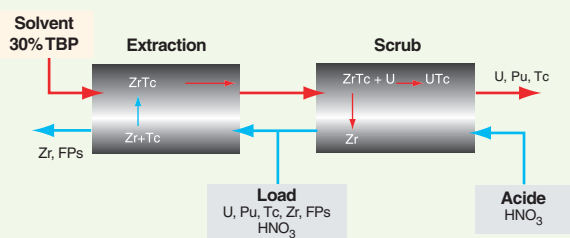

Fig. 106. Technetium behavior in the extraction–scrubbing step.

In the selective plutonium stripping operation, carried out downstream, technetium acts as a catalyst for the destruction of the hydrazine ion, this resulting in increased consumption of this reactant, which is used as a stabilizer for plutonium(III). Specific measures have thus been implemented, to restrict the quantity of technetium reaching the uranium–plutonium partitioning operation. As set out in flowsheet form in Figure 107, this involves inserting a solvent scrubbing operation, at high acidity, to remove some of the technetium from the solvent; and a complementary extraction operation, to recover any uranium and plutonium occurring in the stream yielded by that scrub. The solvent yielded by this operation, recycled as it is in the

main extraction operation, allows the U + Pu load to be kept constant in the solvent. The stripped technetium ends up in the raffinate from that complementary extraction operation.

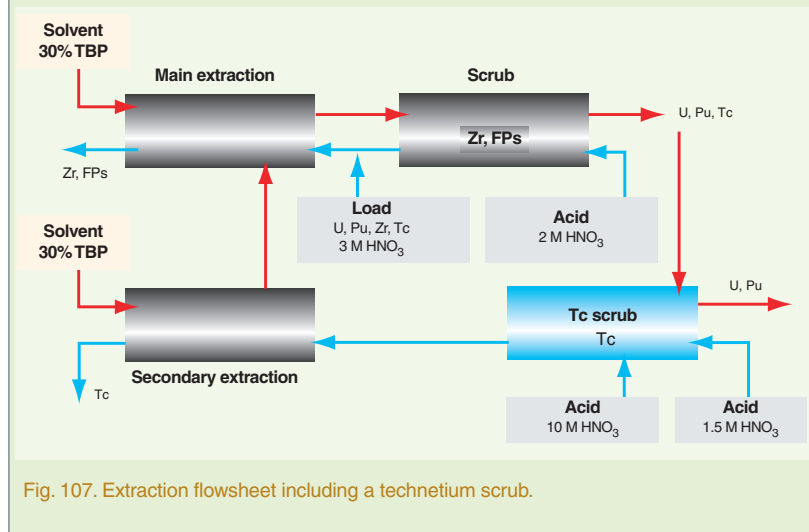

Fig. 107. Extraction flowsheet including a technetium scrub.

## Strategies for the partitioning of minor actinides Am and Cm by solvent extraction

While neptunium and technetium separation, effected jointly with that of uranium, and plutonium, may be carried out by way of an adaptation of the PUREX process (see “Neptunium partitioning”, pp. 104–106), on the other hand, americium and curium separation, in a concentrated acidic medium, is virtually impossible, using TBP. Consequently, novel hydrometallurgical processes, that would allow the recovery of more than 99.9% of americium, and curium, were sought, and developed.

After 5 years’ cooling time, 1 tonne spent UOX fuel, discharged at 60 GWd/tiHM, contains:

- 785 g americium (this including 62.4% Am 241, 37.4% Am 243, and 0.2% Am 242m, these being long-lived radionuclides);
- 135 g curium (8% Cm 245, 1% Cm 243, and 1% Cm 246, as regards long-lived radionuclides; and 90% short-lived Cm 244);
- about 60 kg fission products, one third of this being lanthanides (Ln).

Now, in a nitric acid solution, both groups of elements, i.e. the Ln, and Am + Cm, occur in oxidation state +III, and exhibit similar physicochemical properties:

- they are highly hydrated in an aqueous solution, with closely

similar ionic radii (see the chapters in the section on “Physicochemical properties of actinides”, pp. 11–32);

- classed as “hard acids,” in Pearson’s sense, they set up bonds directly with a variable number of electron-donor atoms (the coordination number), varying from 6 to 12, depending on the chemical system considered;
- they react preferentially with hard bases, such as ligands involving oxygen atoms, by way of electrostatic interactions.

Owing to the similar behaviors exhibited by either group of elements, ligands consisting of hard bases do not allow complete separation of the two groups. On the other hand, ligands involving electron-donor atoms less hard than oxygen (e.g. nitrogen, or sulfur) are known to make An(III)–Ln(III) separation possible,

this being the chief challenge posed by recovery of americium, and curium, from a PUREX raffinate.

The scientific approach adopted at CEA involved the following:

1. The design (making use of the modeling tools available – see the section “Towards relations between structures and extraction properties”, pp. 114–117), or – after suitable surveys of the literature – the synthesis (as an in-house venture, at CEA, or under the aegis of collaborative programs at the national, or international level), and characterization (purity, structural analysis) of new molecules, or older, optimized molecules, meeting the challenge of An(III)–Ln(III) separation.
2. Evaluation of the complexant and/or extractant properties exhibited by the molecules thus synthesized, through a systematic screening of their performance, using solutions simulating process solutions.
3. Gaining an understanding of the mechanisms involved in An(III) complexation, and extraction, by means of thermodynamic, and kinetic investigations at the molecular, and/or supramolecular scale.
4. Investigation of extractant molecule degradation, due to acid hydrolysis, and radiolysis; and development of regeneration treatments for degraded solvents.
5. Acquisition of the distribution data required to arrive at models allowing the calculation, by means of process simulation

codes, of the flowsheets to be used, to test An(III)–Ln(III) separation.

6. Carrying out tests, in continuous mode, in laboratory contactors, first with inactive solutions, to test the system hydrodynamics, then with intermediate-level activity solutions (containing Am and Cm only, in nominal concentrations), and finally using PUREX raffinates (as yielded by spent fuel treatment).

Two main solvent extraction methods are available:

1. Solvation extraction: the organic ligand (L) extracts the metal cation (M) and its counterions (nitrate ions), in the form of a neutral complex,  $[M^{n+}(NO_3^-)_nL_x]$ , which is dissociated, to a varying extent, in the organic phase. Back-extraction of the metal cation is effected in an aqueous medium holding low amounts of counterions, or none at all. This is the case for TBP, in the PUREX process.

2. Cation-exchange extraction: the organic ligand (AH) features an acid function, involving a labile proton. This extracts the metal cation (M), in the form of a neutral complex –  $[M^{n+}(A^-)_n]$ , soluble in the organic phase – releasing into the aqueous phase the required number of protons to keep the system neutral. Back-extraction of the metal cation is effected in a highly acidic medium, to replenish the organic acid with protons. This is the case of di(2-ethylhexyl) phosphoric acid (HDEHP), in the TALSPEAK (Trivalent Actinide–Lanthanide Separation by Phosphorous reagent Extraction from Aqueous [K]complexes) process.

Bearing in mind the nature, and element inventory of the aqueous effluent subjected to treatment (PUREX raffinate), selective An(III) **extraction\*** – these being the minority elements – would seem to be the logically inescapable solution. However, while such a strategy is more straightforward, it is complicated, by the fact that the organic extractant to be optimized (i) has to be a high-performance molecule [since the An(III) are extracted from a relatively concentrated nitric medium, resulting in very strong proton/An(III) competition], and (ii) must prove highly selective, particularly with regard to transition-metal fission products (e.g. Pd, Mo, Zr), and Ln(III).

If selective An(III) extraction proves impossible, out of the effluent subjected to treatment, it may turn out to be advisable to effect An(III) and Ln(III) coextraction, An(III)–Ln(III) separation then being achieved by selective An(III) **back-extraction\***. In the latter case, a water-soluble complexant acts as agent of An(III)/Ln(III) selectivity (e.g.: the polyaminocarboxylic acids used in the TALSPEAK process).

Down to 1997, not one of the systems developed, around the world, since the 1960s, for the purposes of An(III)–Ln(III) separation, could be directly applied to a PUREX raffinate, and a multistep strategy was put forward, to achieve An(III) separation:

1. An initial step of An(III) and Ln(III) coextraction, carried out on a PUREX raffinate, by means of a bidentate oxygenic extractant.

2. A second step of An(III)–Ln(III) separation, carried out on the production solution from the previous step [i.e. on an An(III) + Ln(III) mixture], this being less acidic than the PUREX raffinate.

For the first step, CEA developed the DIAMEX (Diamide Extraction) process, and, for the second one, the SANEX (Separation of Actinides [An] by Extraction) process. Concurrently, other innovative concepts, for the purposes of An(III)–Ln(III) separation, were investigated, in particular the possibility of effecting such partitioning directly from a PUREX raffinate, in a single step. The key to success emerged, when the advantages of two existing processes – DIAMEX, and TALSPEAK – were brought together, with the DIAMEX–SANEX process.

### DIAMEX: An(III) + Ln(III) coextraction

Featuring as they do two solvating amide functions, spanned by a methylene bridge, malonamides (see Fig. 108) are diamides acting as strong complexants of Ln(III) and An(III) cations, by way of a chelating effect (the carbonyl groups acting as hard bases). Consisting solely of carbon, hydrogen, oxygen, and nitrogen (the “CHON” concept), such molecules yield no mineral ashes when incinerated.

Within this family, DMDBTDMA (N,N'-dimethyl-N,N'-dibutyl tetradecyl malonamide) (see Fig. 109) was selected as reference malonamide, for the initial test of the DIAMEX process, in 1993, involving a high-level (high-activity) PUREX raffinate. This test allowed the sensitive points of the DMDBTDMA extractant to be pinpointed, along with the avenues to be followed, to achieve improved process performance, to wit:

- improved solvent extractant properties, together with enhanced extractant stability with regard to hydrolysis, and radiolysis, through structural optimization;

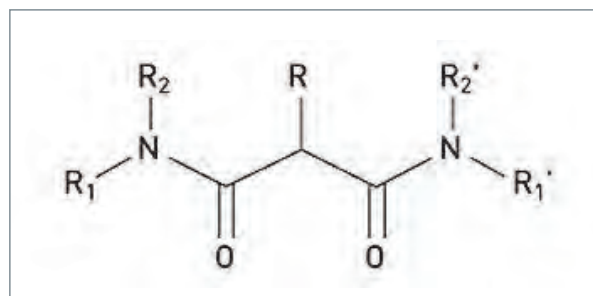

Fig. 108. General formula for malonamides.

- improved selectivity, to preclude extraction, from the acidic solution, of other fission products, such as palladium, molybdenum, and zirconium.

Consequently, improvements were sought to the structure of DMBDMDMA, resulting in DMDOHEMA (N,N'-dimethyl-N,N'-dioctyl hexylethoxy malonamide) (see Fig. 109) being put forward as the new reference molecule. This differs from DMBDMDMA in terms of the following characteristics:

- a higher total number of carbon atoms, increasing the solubility of extracted complexes, and limiting the risk of the loaded organic phase demixing;
- a more uniform distribution of carbon atoms along the alkyl substitution chains in the malonamide, favoring the removal of products yielded by hydrolytic and/or radiolytic degradation (basic scrubs have proved effective, for the purposes of removing acidic degradation products);
- introduction of an ethoxy group into the central chain, to enhance solvent affinity with respect to actinides, and lanthanides.

The reference solvent, for the DIAMEX process, thus consists of DMDOHEMA, diluted to 0.65 mol/l in HTP (the diluent used for the PUREX process), allowing greater margins for the purposes of flowsheet development (see the section on "Partitioning processes for the minor actinides Np, Am, Cm", pp. 118–125). Further, the DIAMEX process involves complexing scrubs, to improve process selectivity, with regard to the extraction of unwanted elements, such as zirconium, molybdenum, iron, and palladium. Oxalic acid is recommended for zirconium, molybdenum, and iron, and HEDTA (hydroxyethylethylenediaminetriacetic acid) for palladium.

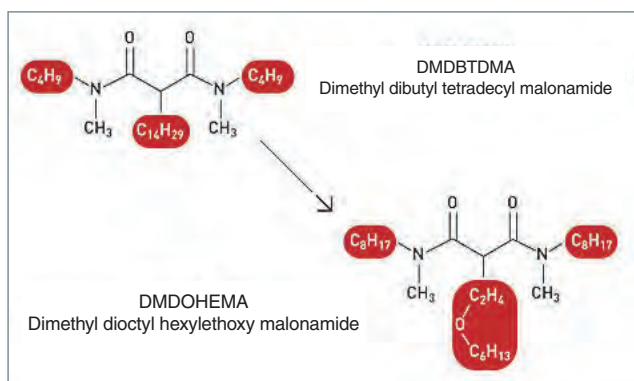

Fig. 109. Structural formulas for the malonamides DMBDMDMA, and DMDOHEMA.

### The TODGA process: an alternative to the DIAMEX process?

Japanese research workers from the Japan Atomic Energy Agency altered the structure of malonamides, by inserting an ether bridge between the two amide functions, thus obtaining new solvating extractants: the diglycolamides (see Fig. 110), these proving more "powerful" than malonamides, though they do involve some other drawbacks (e.g.: third-phase boundary, strontium extraction).

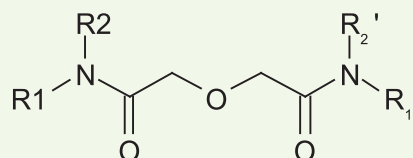

Fig. 110. General formula for diglycolamides.

The reference diglycolamide, for the purposes of An(III) and Ln(III) coextraction, is TODGA (N,N,N',N'-tetra-*n*-octyl-diglycolamide). This has been targeted by thoroughgoing investigations (performance, degradation, system optimization), under the aegis of the EUROPART European collaborative program, for which CEA acted as coordinator, from 2003 to 2007: a countercurrent test was successfully carried out in a shielded cell, at ITU (the Institute for Transuranium Elements, at Karlsruhe [Germany], coming under the European Joint Research Center [JRC]), using a PUREX raffinate (the solvent consisting of TODGA and TBP, diluted to 0.2 mol/l, and 0.5 mol/l, respectively, in HTP).

### SANEX: An(III)–Ln(III) separation

Two types of extractant system were successively investigated, at CEA, for the purposes of An(III)–Ln(III) separation: nitrogenous, or sulfur-bearing synergistic systems, for the "low-acidity" SANEX route; and solvating nitrogen extractants, for the SANEX "BTP" route (see the Box on "Solvating nitrogen extractants", p. 112).

The "low-acidity" SANEX route was investigated as early as the 1980s (and up to 2000). This involved using synergistic mixtures consisting, on the one hand, of a polyazine ligand (e.g. terpyridine, TPTZ [tripyrizyl triazine], ADPTZ [amino-dipyridyl triazine], all tridentate nitrogen ligands), and, on the other hand, an organic acid, acting as cation exchanger (e.g.: carboxylic, or sulfonic acid). In nitrogenous synergistic mixtures, **polydentate\*** polyazine ligands, unable as they are to extract the An(III) by solvation, provide An(III)/Ln(III) selectivity ( $5 < \text{selectivity} < 10$ ), while the organic acid's conjugate base ensures extraction of An(III) complexes to the organic phase.

Preorganization of the polyazine ligands' coordination sites (whether bidentate, or tridentate) proves necessary, in such conditions, to overcome  $An^{3+}$  cation hydration. Such is the case, e.g., with orthophenanthroline, or terpyridine (see Fig. 112), which selectively form complexes with the  $An(III)$ , in an aqueous medium. However, such selectivity vanishes in an acidic medium, owing to the basicity of these ligands ( $pK_a > 4$ ). For that reason, the nitrogen atoms were further slightly “softened,” by delocalizing their excess electronic charge across triazine cycles, as occurs in TPTZ, or ADPTZ (see Fig. 112), these being less basic polynitrogen ligands than terpyridine.

The major drawback involved by synergistic systems has to do with their sensitivity to pH, this requiring, first of all, an adjustment to the aqueous solution's pH (as a rule, to  $pH > 1$ ), and, subsequently, online monitoring of the working pH, making any industrial deployment of such processes problematical, even upstream of the DIAMEX process. Despite this constraint, scientific feasibility demonstration tests were carried out at CEA's Marcoule Center (see the section on “Partitioning processes for the minor actinides Np, Am, Cm”, pp. 118–125), with the ADPTZ–octanoic acid system, and under the aegis of European collaborative programs around the ALINA process (see Box, below).

### The ALINA process

Discovered by Chinese research workers in 1995 [1], bis(2,4,4-trimethylpentyl)dithiophosphinic acid, or CYANEX 301 (see Fig. 111), does not comply with the “CHON” principle. On the other hand, this acid exhibits remarkable selectivity with respect to  $An(III)$  (selectivity  $> 5\,000$ , for  $pH > 3$ ), though it does involve poor chemical stability. Under the aegis of the NEWPART [2] and PARTNEW [3] European integrated projects, both steered by CEA's Marcoule Center, dedicated research efforts were conducted, to optimize the acid's extraction capacity at higher acidity, and improve its hydrolysis resistance: di(chlorophenyl)dithiophosphinic acid (see Fig. 111) was thus obtained. This acid is the main constituent, along with tri-n-octylphosphine oxide, of the sulfur-bearing synergistic mixture used in the ALINA process [4], which allows selective  $An(III)$  recovery from a medium-acidity solution ( $[HNO_3] = 0.2\text{ mol/l}$ ).

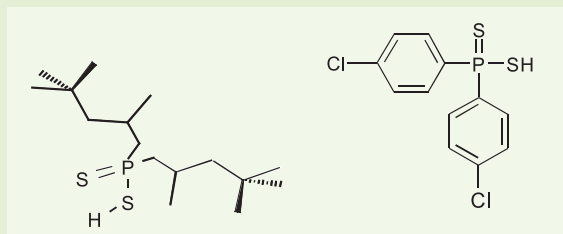

Fig. 111. The CYANEX 301 acid (left), and di(chlorophenyl)dithiophosphinic acid (right).

The SANEX “BTP” route takes its name from the bis-triazinyl pyridines (BTPs), tridentate nitrogen extractants, discovered in 1997 by Z. Kolarik [4], in the context of the NEWPART European integrated program. BTPs differ from TPTZ, and ADPTZ, owing to the specific, asymmetrical configuration of their triazines, endowing them with lower affinity for protons, higher affinity for the  $An(III)$ . These molecules have indeed proved effective, for the purposes of extracting  $An(III)$ , together with their nitrate anions, from relatively concentrated acid solutions ( $[HNO_3] > 1\text{ mol/l}$ ), with  $An(III)/Ln(III)$  selectivity of around 100.

To date, however, the fragility of these molecules has still not made it possible to validate the scientific feasibility stage, for  $An(III)$ – $Ln(III)$  separation, owing to the slow kinetics involved (see the Box “Solvating nitrogen extractants: BTPs, BTPBs, BATPs, BATBPs”, below).

### DIAMEX–SANEX: single-step $An(III)$ – $Ln(III)$ separation

The principle for this partitioning process is set out in Figure 117. Indeed, by combining in one and the same solvent DMDOHEMA (see Fig. 109), which ensures  $An(III)$  and  $Ln(III)$  extraction at high acidity, and HDEHP [di(2-ethylhexyl) phosphoric acid] (see Fig. 116), which ensures the  $Ln(III)$  are kept in the organic phase, whereas the  $An(III)$  are selectively

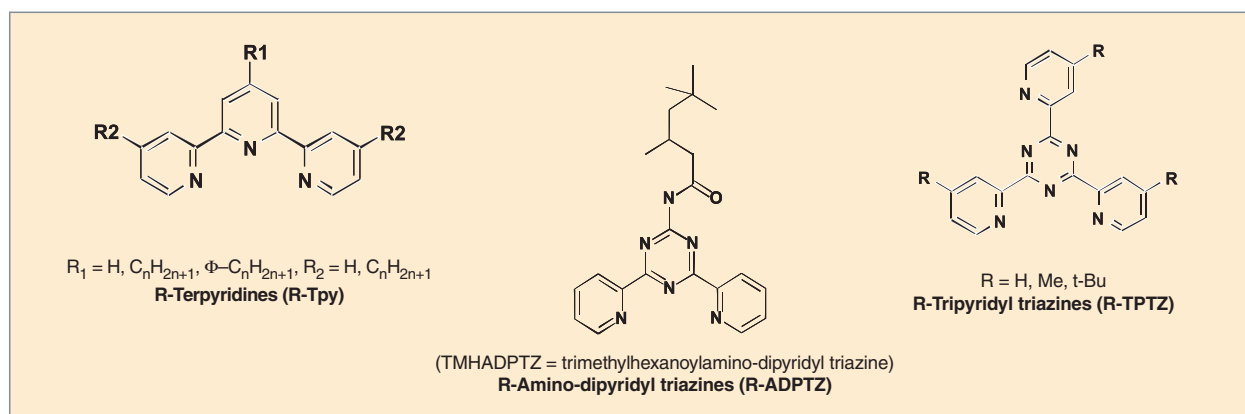
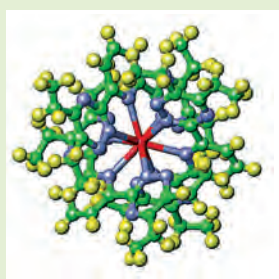
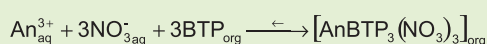

Fig. 112. Polyazine ligands investigated in nitrogenous synergistic mixtures.

## Solvating nitrogen extractants: BTPs, BTPBs, BATPs, BATBPs

Many BTPs were synthesized, and tested at CEA's Marcoule Center, from 1997 to 2002. Parameter studies, carried out with solutions containing actinides and lanthanides in trace form, showed that the nature (length, isomerism) of the alkyl groups attached to the BTP skeleton, as well as their location, influenced not only the performance (in terms e.g. of extraction power, and selectivity) of the BTPs involved, but equally their extraction kinetics, as regards M3+ cations. Structural investigations, carried out on An(III)–BTP complexes, showed that An(III) nitrate extraction could be described by the following solvation equilibrium:



Stoichiometry, as regards the extracted complexes, was confirmed by way of X-ray scattering resolution of their crystallographic structures (see Fig. 113).

Fig. 113. A Ln(III)–bis-triazinyl pyridine complex.

The molecule initially selected, for the purposes of testing the SANEX–BTP process, was 2,6-bis(5,6-di-n-propyl-1,2,4-triazin-3-yl)pyridine (nPr-BTP: see Fig. 114), diluted in a mixture of HTP, and n-octanol. This unfortunately proved to be chemically unstable, in the test carried out in 1999 (see the section on “Partitioning processes for the minor actinides Np, Am, Cm”, pp. 118–125), while complementary laboratory investigations showed degradation, under the action of atmospheric oxygen, nitric acid, or nitrous acid, into hydrophilic alcohol and ketone derivatives, through oxidation of the first carbon atoms in the side alkyl chains. On these grounds, 2,6-bis(5,6-di-isopropyl-1,2,4-triazin-3-yl)pyridine (iPr-BTP: see Fig. 114), featuring as it does branched alkyl chains (this making it chemically more stable, as shown by hydrolysis studies), was selected, rather than nPr-BTP,

in 2001, for the purposes of validating the scientific feasibility of An(III)–Ln(III) separation. On the other hand, iPr-BTP does require, if it is to be fully effective, addition of a phase-transfer agent, and use of pure n-octanol as diluent. The transfer agent selected is DMDOHEMA (the extractant used in the DIAMEX process). In the test involving a high-level solution (see the section on “Partitioning processes for the minor actinides Np, Am, Cm”, pp. 118–125), iPr-BTP proved effective, in terms of actinide recovery (99.9%), and purification with respect to lanthanides, however the molecule did degrade, owing to radiolysis, during the long-duration test.

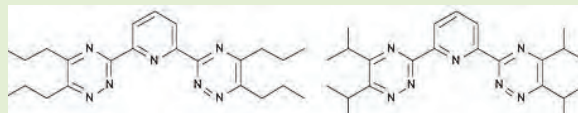

Fig. 114. nPr-BTP (left), and iPr-BTP (right) molecules, used in high-level tests.

Subsequent to the failure of that test, the SANEX “BTP” route was abandoned by CEA; however it has been targeted by further investigations, under the aegis of the EUROPART European program [5]. New tetradentate structures thus emerged: the bis-triazine-bis-pyridines (BTBPs, e.g. CyMe4-BTPB: see Fig. 115), exhibiting similar extraction performance to those of BTPs, but affording the advantage of yielding complexes of M:L2 stoichiometry (rather than M:L3), reducing the impact of extractant degradation on process performance.

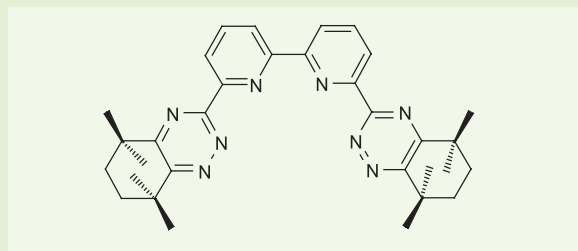

Fig. 115. The CyMe4-BTPB molecule, developed under the aegis of the EUROPART program.

stripped (back-extracted) to the aqueous phase (at low acidity: pH 2–3), by the selective aqueous complexant HEDTA, it became possible to carry out An(III)–Ln(III) separation, directly from a PUREX raffinate (see the section on “Partitioning processes for the minor actinides Np, Am, Cm”, pp. 118–125).

It should be mentioned, however, that the extractant acid, HDEHP, is responsible for the unwanted coextraction of certain fission products (Mo, Ru, Zr), together with the lanthanides. Such coextractions not being preventable by any addition of aqueous complexants in the initial solution, these fission products have to be specifically stripped from the solvent, in complementary, dedicated steps. Such stripping is indispensable, prior to solvent recycling, to preclude the buildup of some fission products, which might have adverse effects on process

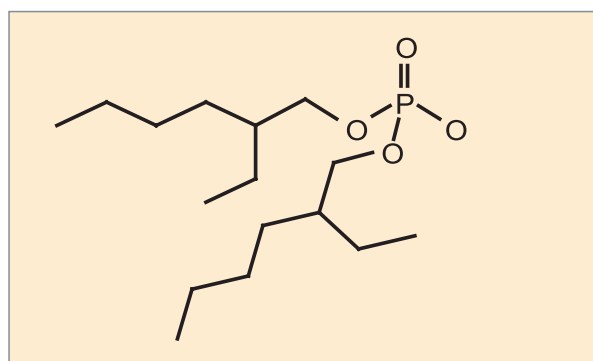

Fig. 116. Di(2-ethylhexyl) phosphoric acid (HDEHP).



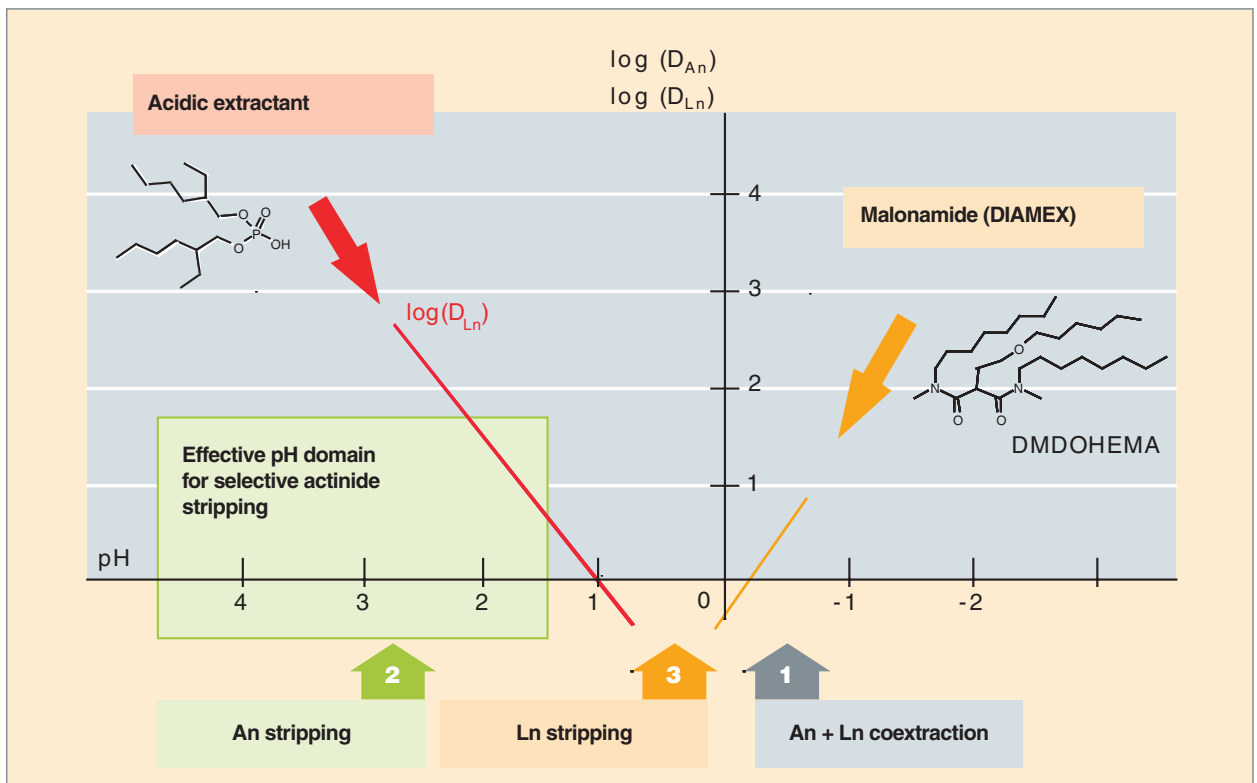

Fig. 117. Principle diagram of the DIAMEX–SANEX process.

hydrodynamics. Molybdenum and ruthenium are stripped upstream of the actinides, by bringing down acidity, from 3 mol/l to pH 3, whereas zirconium and iron are stripped downstream of the actinides, and lanthanides.

Currently ongoing research work, at CEA, seeks to simplify this process, which does yield a large amount of effluents. One optimization being considered involves inserting into the process an online separation step, for the two extractants, which would allow the uncoupling of the An(III) + Ln(III) coextraction step, at high acidity (involving a loop similar to the DIAMEX process loop), from the An(III)–Ln(III) separation step, at low acidity (involving a loop similar to the TALSPEAK process loop), thus avoiding the unwanted extraction of fission products Mo, Ru, Zr. Such modifications entail looking for a new organophosphoric acid, bringing the advantages afforded by HDEHP, while being readily separable from DMDOHEMA.

### Prospects for new extractant molecules

An(III)–Ln(III) separation does still stand as the most difficult step involved, in minor actinide recovery, owing to the very closely similar chemical properties exhibited by the An(III), and Ln(III). Most of the processes developed, over the past 40 years, and more, around the world, entail two successive steps: (i) an initial An(III) and Ln(III) coextraction step, allowing a reduction in the element inventory to be achieved (two thirds of fission products being kept out), while the acidity of the efflu-

ent undergoing treatment is lowered; (ii) a second An(III)–Ln(III) separation step, effected either through selective An(III) extraction, i.e. of the minority elements (in many cases, after adjusting the effluent's acidity, except with solvating nitrogen extractants), or by selective An(III) back-extraction, using a hydrophilic extractant, of the polyaminocarboxylic acid type, to a medium buffered with carboxylic acid.

The original feature of the DIAMEX–SANEX process, based as it is on use of HDEHP and DMDOHEMA, is that it effects An(III)–Ln(III) separation in a single cycle, from a PUREX raffinate. It combines two extractants, working in different acidity domains. However, the streams thus generated are large. Consequently, research is ongoing, to simplify the process: the malonamide would no longer be mixed with the phosphoric acid, for An(III) and Ln(III) coextraction, but only mixed prior to the selective An(III) stripping step. This would preclude the unwanted extraction of certain fission products, while simplifying treatment of degraded solvents.

Solvent irradiation tests are being carried out, at the same time, in the MARCEL loop, fitted with a gamma irradiation device, to evaluate ligand stability with regard to acid hydrolysis, and radiolysis.

Concurrently with process development studies, structural investigations are also being conducted at CEA's Marcoule Center, on the new molecules and their complexes, to determine their structures, and stoichiometries.

## Towards relations between structures, and extraction properties

### The contributions from molecular, and supramolecular chemistry

The development of An(III)–Ln(III) separation processes requires a good understanding of the elementary physico-chemical processes governing the thermodynamics, and kinetics of mass transfers between liquid phases. Researchers at CEA's Marcoule Center, and ICSM (Institut de chimie séparative de Marcoule: Marcoule Separation Chemistry Institute) can draw on a full battery of analytical tools, both conventional and adapted for nuclear purposes, allowing the investigation of complexes at the molecular scale (e.g. NMR, UV–Vis. spectrophotometry, EXAFS, TRLS, microcalorimetry, mass spectrometry coupled with ESI, GPC, etc.), or supramolecular scale (e.g. SANS, SAXS).

The inherent complexity of the chemical systems used in hydrometallurgical actinide separation processes means it is often not possible to identify precisely the underlying physico-chemical phenomena, whether in qualitative, or quantitative terms. Now, accurate knowledge of such phenomena affords the ability to arrive at operating behavior models more readily lending themselves to qualification, in operational domains, and possible extrapolation beyond these domains.

To make some headway in this area of knowledge, a molecular approach to the physicochemistry of extracted phases is being developed, with ATALANTE. The purpose of this approach, aside from the characterization of systems of interest, concerns the determination of – ideally quantitative – relations between structures, and properties, and the quest for objective, physical criteria, to be observed at a variety of scales (macroscopic, microscopic, molecular scales), entering into relations that may be determined, and modeled.

Out of the various aspects that have been explored, a number of findings are presented in the following paragraphs, concerning organic phase structuring, with respect to malonamides; and the issues of affinity, and selectivity, from a thermodynamic standpoint, with regard to polyheterocyclic nitrogen extractants.

### The molecular approach developed in ATALANTE

The investigation is concerned with the organic phase, in the operating conditions prevailing for hydrometallurgical actinide separation processes. The aim is, first of all, to characterize chemical systems involving metal salts of various kinds, the surrounding water and acid that may be associated to the constituents of such salts, and the various components entering in the formulation of organic compounds exhibiting a marked hydrophobic character. The manifest complexity of the samples investigated is compounded by difficulties arising from their radioactivity, entailing that they be handled in alpha-qualified laboratories.

In the ATALANTE facility, a laboratory is dedicated to physical measurements on radioactive samples: mass spectrometry, nuclear magnetic resonance spectroscopy, vibrational or fluorescence spectroscopy, etc. Figure 118 sets out the overall approach implemented, to extend our knowledge of the chemistry involved in actinide complexation, and extraction by an organic phase.

Chemical systems entering into an equilibrium may be conceptualized, and modeled, on the basis of a variety of reference frames, depending on whether the aim is to describe these systems in terms of the energies involved, electron behavior in molecular orbitals – the foundation of chemical reactivity – or mechanics, and geometry. The basic data, and parameters for these various concepts may only be arrived at, as a rule, through the drawing up of chemical models, to be compared with sets of experimental physical data.

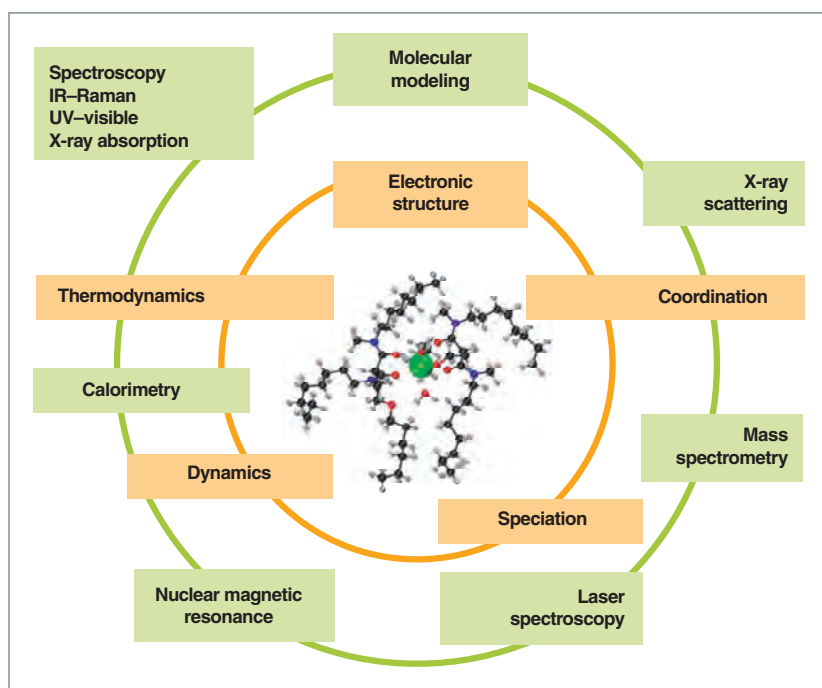

Fig. 118. The molecular approach for actinide complexation and extraction chemistry.

Aside from the difficulty of bringing together a range of measurement techniques that may be used with actinides, it should be pointed out that some of these techniques have undergone major developments, of late. Mention may be made, e.g., of mass spectrometry, which now allows the characterization of noncovalent complexes in solution; the remarkable advances achieved as regards quantum-chemical molecular modeling software; or the commissioning of the MARS beamline, dedicated to actinides, in the SOLEIL synchrotron (France).

For a given extractant system, depending on the goals set, in terms of separation, and the kind of formulation involved, the specific physicochemical characteristics observed may entail a variety of cognitive approaches. The following examples will allow two successful approaches to be presented.

### **The molecular and supramolecular structure of liquid extraction phases: the case of malonamides**

Compounds from the malonamide family provide good extractants, as regards f-block elements, and they are being investigated for the potential they afford, with respect to minor actinide partitioning processes, from a PUREX extraction raffinate. Malonamides are neutral solvating extractants, exhibiting a moderately surface-active character. They extract metallic elements in ion form, together with the mineral anions present in the media considered, nitrates as a rule. They exhibit a high loading capacity, and extract water, and acid efficiently.

Owing to their surface-active character, malonamides induce a form of liquid phase structure, the structure varying, depending on relative constituent concentrations.

Put simply, the malonamides' polar heads preferentially interact with the extracted salts, and water, while the nonpolar regions – lipophilic aliphatic chains – combine with molecules of the diluent, which is itself aliphatic, and nonpolar. Above a given extractant concentration, the so-called critical micellar concentration – this depending on the extractant being used – the outcome is the formation of molecular aggregates, as shown in Figure 119, comprising a polar core – extracted salts and acid, water, and malonamide polar heads – and a nonpolar shell – aliphatic chains – the size of which depends on physicochemical conditions.

In-depth investigations [6] have shown that, with rising extractant and extracted solute concentrations, phase structure may become increasingly complex, with the formation of lamellar phases, as shown in Figure 120. The emergence of such lamellar phases is concomitant, as a rule, with gelation of the solutions. Beyond certain boundary conditions, growing interactions between aggregates may result in phase instability, with the formation of two organic phases, one extractant- and solute-rich, the other mainly consisting of diluent: this is the third-phase boundary.

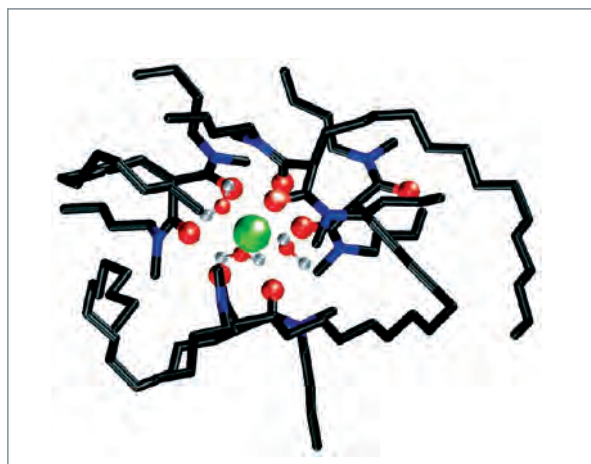

Fig. 119. Representation of an aggregate formed in the extraction of a metal cation by malonamides. The polar core comprises the metal cation (in green), ligand polar heads (oxygen atoms shown in red), and water molecules. The nonpolar shell comprises the hydrocarbon chains (carbon atoms shown in black).

The onset of gels, and such demixing into two, distinct organic phases raise issues, with regard to process deployment. Indeed, the equipment commonly used is designed to cater only for a single organic phase, which, moreover, must be relatively fluid (see the Box “The third phase phenomenon”).

Investigations have been carried out, in homogeneous liquid phase conditions, with compounds serving as models for malonamides. On the basis of structural data – single-crystal X-ray scattering, EXAFS (extended X-ray absorption fine structure), solution fluorescence – and thermodynamic data [7], it was possible to analyze the speciation data thus obtained for the extractant systems, and show the dominant contribution of hydration in extraction behavior.

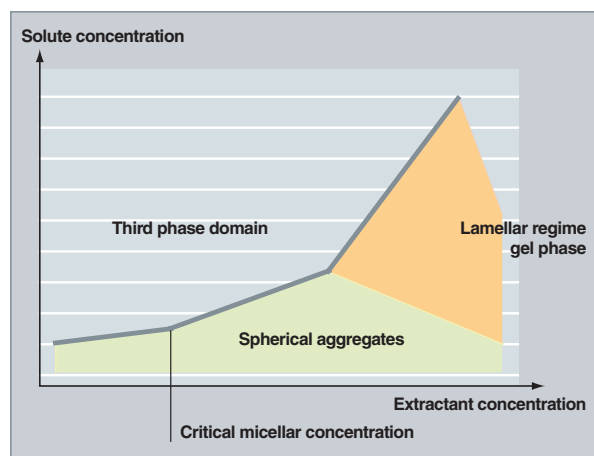

Fig. 120. Behavior of the phases extracted by malonamides, depending on extractant and solute concentrations in the organic phase; and third-phase emergence domain.

### The third phase phenomenon

One of the issues encountered, with liquid–liquid extraction processes, is the emergence of third phases, i.e. the abrupt separation of the organic phase into two separate phases, as a result of saturation. Such macroscopic demixing phenomena may be related to the organization of the extractants, in the organic phase. Indeed, by applying the concepts of colloid chemistry to organic phases involving diamides, it was possible to show these molecules are organized in the form of small aggregates, comprising a polar core, with a radius ranging from 0.5 nm to 1.2 nm (comprising the polar heads from the extractant, and extracted solutes), surrounded by a nonpolar shell, consisting of hydrocarbon chains from the diamide, and from the diluent. The average aggregation number stands at around 4–10 diamide molecules per aggregate.

The stability of the organic phases is the outcome of the equilibrium set up between the forces prevailing between aggregates, induced by: (i) repulsion between impenetrable, hard cores; (ii) repulsion between aggregates, due to interactions between

hydrophobic alkyl chains from the diamide involved in the complex, and from the diluent (repulsive steric stabilization); (iii) attraction between the polar heads of the diamide in the complex (van der Waals force). Demixing is governed by the interactions between aggregates: it occurs when attractive interactions become dominant, relative to thermal agitation in the solution. Thus, organic phase stability may be improved by modifying the parameters influencing the attractive, and repulsive forces arising between aggregates. The attractive forces are dependent on polar core composition, increasing with extracted solute concentration, and core polarizability (this depending on the nature of the extracted salt). The repulsive forces relate to the aggregate's nonpolar shell, and are dependent on chain lengths, in the extractant, and in the diluent, these exerting opposite effects on interactions between aggregates. Demixing is shifted further to high solute concentrations, when extractant alkyl chains are longer, while those in the diluent are shorter (stabilization by steric repulsion). Diamide solutions behave as reverse microemulsions, stabilized by surfactants.

Investigations have been launched, to ascertain the role played, at the molecular scale, by the ether function featured by DMDOHEMA. Indeed, process development studies have resulted in this extractant being selected, over its aliphatic counterparts, with no rational explanation being adduced, and corroborated. The above-mentioned single-crystal X-ray scattering data showed this ether function is unable to interact directly with the metal cation, hinting at the involvement of a more complex stabilization mechanism. On the basis of experimental structural data, obtained by nuclear magnetic resonance, simulations of the complexes formed, in solution, were carried out, using molecular dynamics. This study concluded that a water molecule is directly involved in the complex, acting as a bridge between the metal cation, and this ether function in the ligand (see Fig. 121). Complementary nuclear mag-

netic resonance measurements, carried out on the hydrated lanthanum and DMDOHEMA complex, confirmed the presence of a water molecule in the metal cation's first coordination sphere.

Thus, in the operating conditions prevailing for the use of malonamide extractants, beyond the critical micellar concentration, the molecular structure of the complexes formed, and the supramolecular structure of extracted phases prove complex, while the part played by water, in the stability of the structures formed, is crucial. The extractive efficiency displayed by malonamides is related to their ability to accommodate directly a major fraction of the aqueous load accompanying solute transfer to the organic phases.

#### **Extraction thermodynamics: the case of polyheterocyclic nitrogen extractants**

Polyheterocyclic organic nitrogen ligands, some instances of which are shown in Figure 122, are being investigated with regard for their selectivity, for the purposes of actinide(III)–lanthanide(III) separation.

Most known ligands turn out to be effective in synergistic extraction conditions, with extractants of the fatty acid type, their extraction capability being restricted to weakly acidic media. Molecules from the bis-triazinyl pyridine family are the only ones having the ability to extract actinides, acting alone, from a concentrated acid medium. The extraction mechanisms involved are essentially molecular ones, loading capacity, as well as the quantities of water and acids extracted being low, compared to what is found with malonamides. At high solute concentrations, the chief limit occurs with the precipitation of the complexes formed, and this limit may be pushed back,

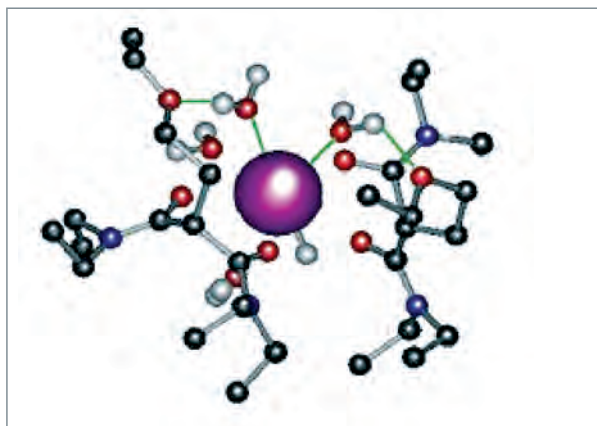

Fig. 121. Snapshot of the  $[\text{La}(\text{N},\text{N},\text{N}',\text{N}'\text{-tetraethyl ethyloxyethyl malonamide})(\text{H}_2\text{O})_5]^{3+}$  complex, during a molecular dynamics simulation (bridging bonds set up by water molecules are shown in green).

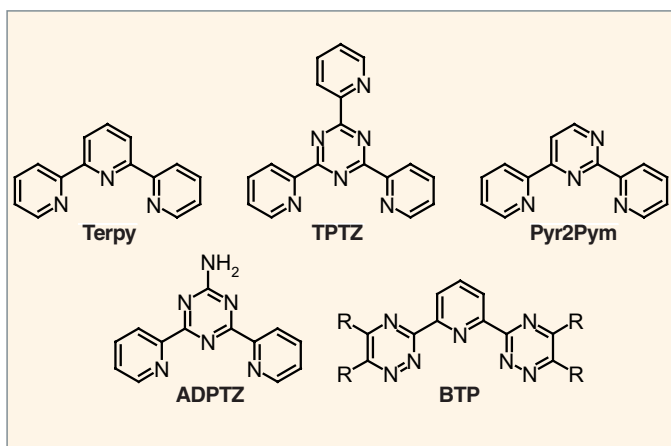

Fig. 122. Examples of polyheterocyclic organic nitrogen ligands, acting as selective actinide(III) ligands, investigated for the purposes of implementing the SANEX actinide(III)–lanthanide(III) separation step.

through use of polar diluents, such as octanol, or malonamides.

Numerous coordination chemistry studies have sought to relate the selectivity observed, in extraction conditions, to the differences of a geometrical nature, measurable in analogous actinide(III) and lanthanide(III) compounds. Quantum-chemical molecular modeling studies have corroborated the ability of the models employed to describe the systems being investigated [8]. However, findings from X-ray scattering measurements on isolated compounds in the solid state, or EXAFS measurements on compounds in solution have not allowed any conclusion to be drawn as to any actual significance of structural differences.

According to the principles of the hard–soft acid–base (HSAB) theory propounded by R. G. Pearson, bases, or electron-charge density donors, preferentially interact with acids, or acceptors; and hard compounds, of small size and ionic in character, interact with other hard compounds, while soft compounds, weakly charged, and readily polarizable, interact with other soft compounds.

According to these principles, actinides(III), acting as they do as less hard acids than lanthanides(III), should exhibit greater affinity for soft donor extractants. To corroborate that surmise, a systematic complexation thermodynamic data acquisition campaign was launched [9]. These data are set out in Figure 123.

In the formalization used to describe molecular orbitals, the HSAB theory correlates directly with interaction between frontier orbitals, and thus with the energy differential between highest occupied, and lowest unoccupied molecular orbitals. In Figure 123, ligands are ranked by order of ascending hardness, as computed by quantum chemistry. It is apparent that, for a given cation, the stability of the first complex formed is correlated with ligand hardness, however no direct connection may be derived, from this, between hardness, and selectivity.

A thermodynamic approach of actinide(III) and lanthanide(III) complexation was developed [10], to investigate the issue of selectivity. Figure 124 sums up the findings of the exhaustive investigation of the complexation of these elements by 2-amino-4,6-di-(pyridin-2-yl)-1,3,5-triazine (ADPTZ), the chemical formula of which appears in Figure 122.

It is apparent that selectivity is chiefly related to the enthalpy term, formation of actinide(III) complexes being more highly exothermic than that of lanthanide(III) complexes. The conclusion may be drawn, from this observation, of a more highly covalent character of the bonds set up with actinides(III). Quantum-mechanical molecular modeling computations corroborate this finding, as regards lighter actinides.

As regards bis-triazinyl pyridines, the investigation was carried out in a homogeneous phase, as well as in extraction conditions. In this case also, the enthalpy component governs the processes involved, be it as regards complexation/extraction effectiveness, or actinide(III)/lanthanide(III) selectivity. With these chemical systems, it is further found that metal cation hydration, and solvation of the structures formed are crucial processes, owing to their contribution to energy balances, par-

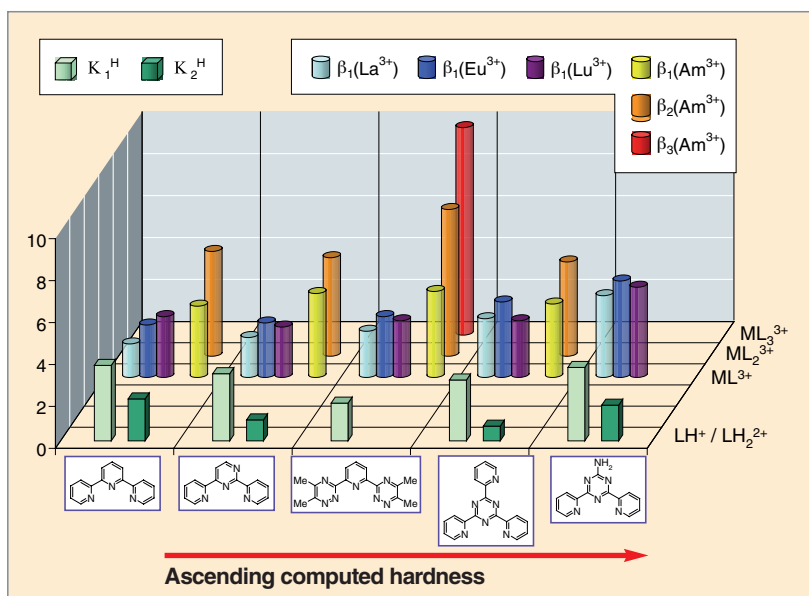

Fig. 123. Dissociation constants ( $K_1^H$ ,  $K_2^H$ ) for protonated species, and formation constants ( $\beta_1$ ,  $\beta_2$ ,  $\beta_3$ ) for  $\text{La}^{3+}$ ,  $\text{Eu}^{3+}$ ,  $\text{Lu}^{3+}$ , and  $\text{Am}^{3+}$  complexes, for a number of nitrogen ligands.

### Thermodynamic formalization of extraction, and complexation

Let us consider a thermodynamic system, involving the isothermal, isobaric extraction of a metal cation by a solvent: i.e. a system involving, in the initial state, two distinct compartments, one holding the cation, dissolved in the aqueous phase, the other containing the solvent; and, in the final state, the contacted system, at equilibrium, with the cation extracted to the organic phase.

In the final state, provided the system remains isolated, Gibbs free energy (free enthalpy)  $G$  is at a minimum value, entropy  $S$  at maximum value. The variation in enthalpy  $H$ , for the system, is equal to the heat received by the system,  $Q$ , these quantities being related as follows:

$$\Delta G^\circ = \Delta H^\circ - T\Delta S^\circ$$

The variation in Gibbs free energy,  $\Delta G^\circ$ , is a measure of the system's stability. The transformation occurs spontaneously when this is negative.

The variation in enthalpy,  $\Delta H^\circ$ , provides an indication of the balance of bonds set up, and broken, thus serving as an overall measure of the nature, and force of these bonds. This is a quantity that may be empirically determined, and computed using the tools of quantum chemistry.

The variation in entropy relates to the evolution in the disorder the system involves, and thus to the geometrical aspect of coordination.

In the case of a transformation that can be associated to a chemical complexation equilibrium, the variation in Gibbs free energy is related to the reaction's equilibrium constant  $K$  through the following equation, derived from the mass action law:

$$\Delta G^\circ = -RT \ln K$$

By means of this relation, the variation in Gibbs free energy may be evaluated.

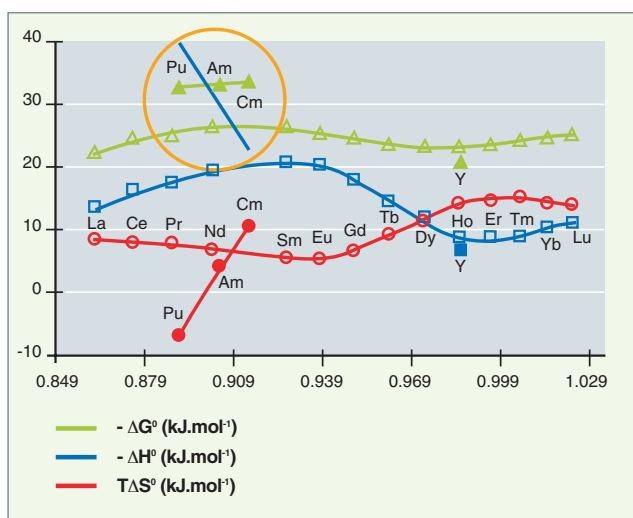

Fig. 124. Variations in Gibbs free energy (free enthalpy), and in the enthalpy and entropy components involved in yttrium(III), lanthanide(III), and actinide(III) complexation by ADPTZ, referred to cation size (Ref.: M. Miguiritchian, CEA).

ticularly when referred to the energy differences corresponding to globally observed selectivities.

The tools, and approaches used for the investigation, at the molecular and supramolecular scales, of actinide extractant systems allow the detailed, finescale characterization of these systems. They allow rules and principles to be identified, that may serve as the basis for the relations intervening between extractant structure, and physicochemical, macroscopic properties, and thus yield mastery of such extractant systems, as regards their optimization, and deployment.

## Partitioning processes for the minor actinides Np, Am, Cm

### What strategy should be adopted, for the separation of americium and curium from lanthanides, and other fission products?

Owing to the difficulties involved in actinide(III)–lanthanide(III) separation, the diversity of the elements present in the initial medium, and the high acidity of the solution subjected to treatment, for the purposes of selective minor actinide (Am, Cm) recovery from the PUREX process raffinate, a three-step strategy was developed (see Fig. 125):

- **step 1:** the DIAMEX process, involving actinide and lanthanide coextraction from the PUREX process raffinate, using a molecule from the malonamide family. The second step is thus facilitated, since a fraction of the FPs has already been removed, while the acidity of the solution undergoing treatment has been brought down (to 0.5–1 mol/l, rather than 3–4 mol/l);
- **step 2:** the SANEX process, ensuring the partitioning of actinides(III) (Am + Cm) from lanthanides(III);
- **step 3:** the Am–Cm separation process.

As regards research work, the exploratory phase was mainly concerned with the second (SANEX) step, this, at first blush, being the most difficult one, owing to the very closely similar chemical properties exhibited by actinides(III), and lanthanides. Thus, two partitioning routes were explored concurrently:

The so-called “direct” route, involving selective actinide(III) extraction from the lanthanide-rich DIAMEX solution. This strategy, relying as it does on the selective extraction of the elements of interest [actinides(III)], limits the risks of solvent saturation. These investigations were carried out with nitrogen ligands, more particularly with molecules from the BTP family, as mentioned earlier.

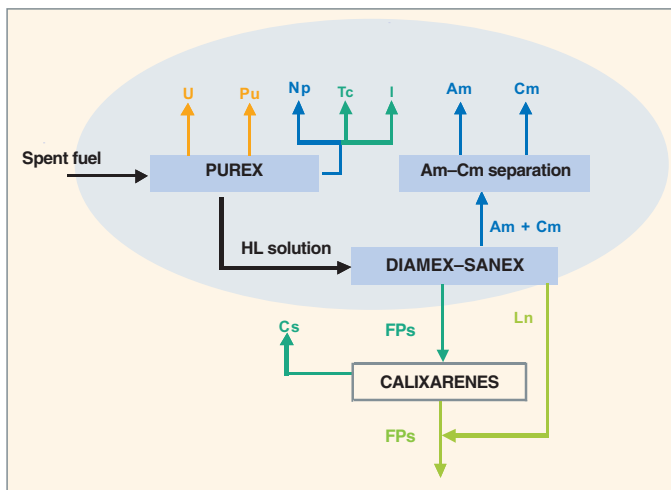

Fig. 125. The main steps involved in minor actinide partitioning.

The **reverse route** relies on **selective actinide(III) back-extraction** from the An(III) + Ln(III)-loaded diamide, involving, in this case, use of a selective actinide(III) complexant. This option opens the way to the integration into a single cycle of the DIAMEX and SANEX processes.

An alternative route, the so-called “**low-acidity route**,” is based on the same criteria as the direct route, however it involves an adjustment to the acidity of the DIAMEX solution, through the addition of a buffer reagent. Indeed, those systems, other than BTPs, that allow An(III)–Ln(III) separation are effective only in domains for which  $\text{pH} > 2$ .

### The scientific feasibility phase: concept selection

The point, for this phase, was to validate the basic concept, this involving:

- identifying the extractant system that would allow the required performance to be achieved, in terms of recovery rate, and purity of the separated actinides;
- verifying the absence of unacceptable issues, with a view to the subsequent phases (technical, and industrial feasibility).

In concrete terms, this involved small-scale, laboratory tests, with actual solutions (as yielded by spent fuel treatment), of the core of the process (extraction–back-extraction), subsequent to which recovery rates were measured, for the target elements.

### Advances with the DIAMEX process, from 1993 to 2001

As early as 1993, an initial test of the concept, carried out at CEA’s Fontenay-aux-Roses Center, on a PUREX raffinate yielded by treatment of a MOX fuel, using a malonamide, dimethyl dibutyltetradecyl malonamide (DMDBDMA), as extractant, proved promising: more than 99% of lanthanides and actinides were recovered.

This test further allowed R&D directions to be identified, that should be followed to achieve improved process performance, these directions involving, from 1994 to 2001, a number of tests, carried out on synthetic, or high-level solutions. Carried out in liquid–liquid contactors, of the mixer–settler cascade, or centrifugal extractor type, these tests demonstrated the process’s flexibility, while retaining actinide recovery rates close to, or higher than, 99.9% (see Table 16).

Finally, the results achieved in simulated, and subsequently in actual conditions showed that the solvent exhibits adequate stability, for the purposes of industrial use. The basic scrubs carried out, as a result of research carried out concurrently (see Fig. 126), are sufficiently effective to remove the acidic degradation products yielded by solvent degradation.

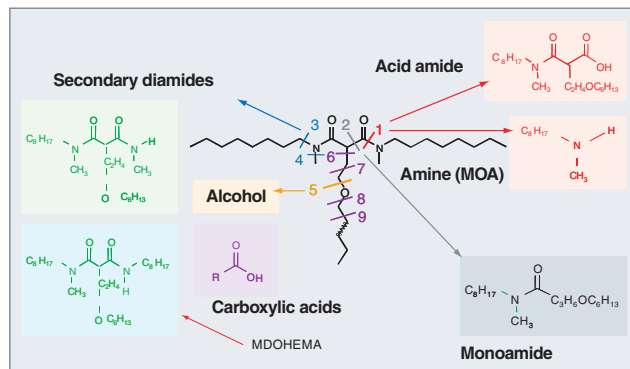

Fig. 126. DMDOHEMA, and its chief degradation products.

### Advances with the SANEX process during the exploratory phase

#### The “direct” route: still inadequate extractant stability

As regards the “direct” route, many molecules were tested, the best performance being achieved with extractants of the bis-triazinyl pyridine (BTP) family (see the Box “Solvating nitrogen extractants”, p. 112). While encouraging, the first tests carried out on actual solutions, in ATALANTE, and at ITU (Germany) confirmed a lack of stability, characterized by degradation of this molecule, accounted for by the position of certain carbon atoms.

Table 16.

Main results of DIAMEX process tests.							
Date	1993	1995	1997	1998	1998	1999	2000
Solution	Actual	Simulated	Simulated	Actual	Simulated	Actual	Actual
	High-level	Inactive	Inactive	High-level	+ traces	High-level	High-level
Duration	16 h	22 h	18 h	4 h	11 h	45 h	38 h
Extractant	DMDBTDMA	DMDBTDMA	DMDOHEMA	DMDBTDMA	DMDBTDMA	DMDOHEMA	DMDOHEMA
Load	MOX	MOX	UOX	UOX	UOX	MOX	MOX
		simulated	simulated		simulated		> 99.9% Am
Product	> 99.9% Am	> 99.8% Nd	> 99.8% Nd	> 99.7% Am	98.9% Am	~ 99.9% Am	> 99.9% Cm
	~ 99.9% Cm	> 99.8% Ce	> 99.8% Ce	+ Cm	98.2% Eu	+ Cm	~ 60% Y
	86% Fe	99% Eu	> 98.5% Eu	~ 18% Y	1% Ru	Zr, Mo < dl*	< 0.2% Zr
	97.6% Mo	73% Fe	0.5% Fe	~ 85% Pd		~ 60% Pd	< 0.3% Mo
	~ 33% Ru		3.4% Ru	~ 9% Ru		~ 10% Ru	< 0.2% Pd
							< 1.2% Ru

\* dl: detection limit for the analytical method used

### The “reverse” route: an avenue for “advances”

The SANEX flowsheet was optimized, with the implementation of 5 treatment steps, for the purposes of catering for the impact of fission products – such as, e.g., zirconium, molybdenum, and palladium – on An(III) separation, recovery, and purification. Tests carried out in the laboratory, with actual solutions, show outstanding performance. Recovery rates are higher than 99.9%, as regards americium, and 99.7% for curium, with actinide/lanthanide purification factors standing higher than 800.

Owing to its effectiveness, this process was deemed to be the most promising, in the short term – even though it does require five steps – for the purposes of conducting the technical feasibility demonstration tests, scheduled for 2002–2005.

### What of Am–Cm separation?

After investigating other variants, in particular the SESAME pathway, it was finally decided to opt for a liquid–liquid extraction process, relying on the differences in affinity exhibited by certain extractants, for americium, and curium, respectively.

The issue of compatibility with plant operational constraints (in terms of operation, and secondary waste yield) led to diamides being selected, such as DMDOHEMA.

Using, as extractant, DMDOHEMA, already employed as it is in the upstream steps of the minor actinide overall partitioning process (DIAMEX–SANEX), makes it possible to draw on the operational feedback accruing to date, and suggest a common solvent stream management.

A parameter study allowed the influence to be evaluated, of the concentrations of the various components in the system [DMDOHEMA, HNO<sub>3</sub>, An(III)], along with the influence of temperature, on americium and curium extraction by DMDO-

HEMA. The Am(III)/Cm(III) separation factor was found to be virtually constant, close to 1.6, regardless of experimental conditions (see Fig. 127).

Owing to this low separation factor, a high number of stages (more than 40 or so, for the extraction–scrubbing steps, 8 for the stripping step) is required, to separate americium from curium, in accordance with target performance levels, i.e.: extraction of 99% of the americium, with less than 1% of initial curium; and, respectively, recovery of 99% of the curium, with less than 1% of the initial americium, from the extraction raffinate.

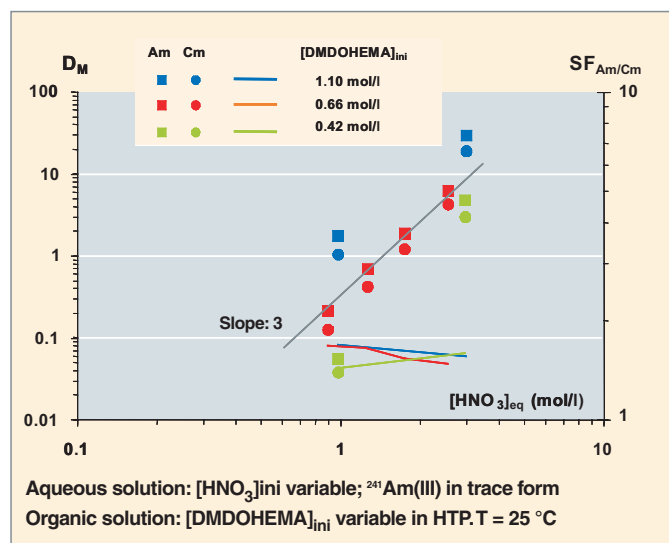

Fig. 127. Isotherms for extraction–dependence on nitric acid concentration, of distribution coefficients for americium, and curium. The separation factor, SF<sub>Am/Cm</sub>, between these two elements is virtually constant, standing close to 1.6, large enough to serve as the basis for a multistage separation process.



## The SESAME electrochemical route for the separation of americium only

During the exploratory phase, the SESAME (*Séparation par extraction sélective de l'américium par méthodes électrochimiques*: Separation through selective extraction of americium by

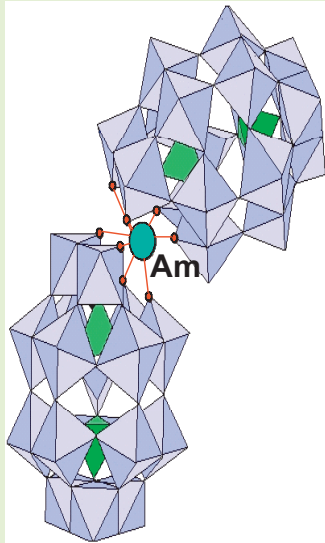

Fig. 128. A structure involving americium, in oxidation state IV, stabilized by heteropolyanions.

electrochemical methods) process was thoroughly investigated, for the purposes of Am–Cm separation.

The SESAME process relies on the selective, gradual oxidation of americium to oxidation state +IV, and subsequently +VI, by means of an electrically formed mediator. A lacunary heteropolyanion (LHPA) is used to stabilize – by complexation – the intermediate state (see Figs. 128, 129).

In principle, the SESAME process could be considered for use as early as the second step, this then involving direct use of the production stream from the DIAMEX process, to effect, at that point, recovery of americium only. In that case, other elements need to be taken into account, aside from Am, namely oxidizable elements present, as impurities, in the stream being processed, consequently increasing the amount of reactant required. It should be noted that, in this option, curium is not separated from the lanthanides, and must be managed jointly with the other fission products.

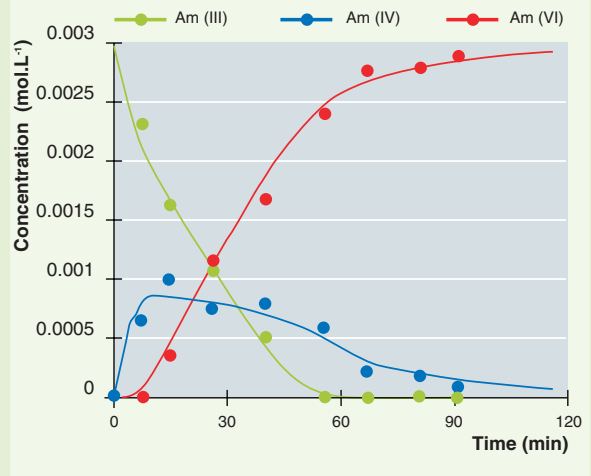
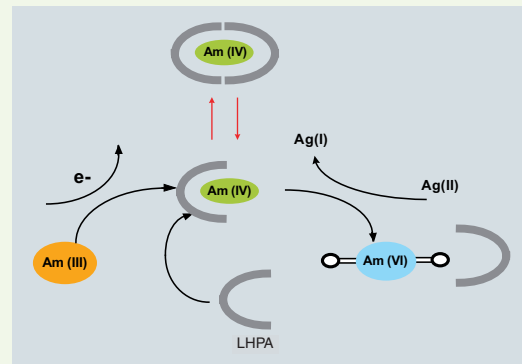

Fig. 129. Principle of the SESAME process; and kinetics of americium(III) oxidation to americium(VI).

A demonstration test, carried out with a reconstituted solution, of americium at nominal concentration, and curium at a lower concentration, was carried out in December 2002 (see Fig. 130). Performance, in terms of recovery rate, and decontamination, being highly sensitive to variations in temperature, flow rates, and acidity, online spectrophotometric monitoring of americium, at 5 strategic points, allowed, through the comparison of measured concentrations with model predictions, effective management of the test, and the achievement of the target performance levels:

- 0.6% of the initial americium remaining in the curium production stream;
- 0.7% of the initial curium remaining in the americium production stream.

**The scientific feasibility of this concept** [Am(III)–Cm(III) separation by liquid–liquid extraction, in the stable oxidation state for these elements] is thus **demonstrated**.

From 2002 to 2005, investigations were directed at providing a full demonstration of the processes, with a view to their future industrial deployment. This demonstration, based on the separation processes selected at the outcome of the scientific feasibility studies, involved:

- the simultaneous testing of all steps in the process; in particular, the solvent treatment step was included, the solvent then being recycled;
- experimenting with these steps, at a scale more representative of industrial conditions, in particular with respect to the points in the process deemed to be more sensitive.

Thus, as regards the DIAMEX and SANEX processes, with regard to sustained operations over time, solvent resistance to radiolysis, and hydrolysis was tested in an irradiation loop.

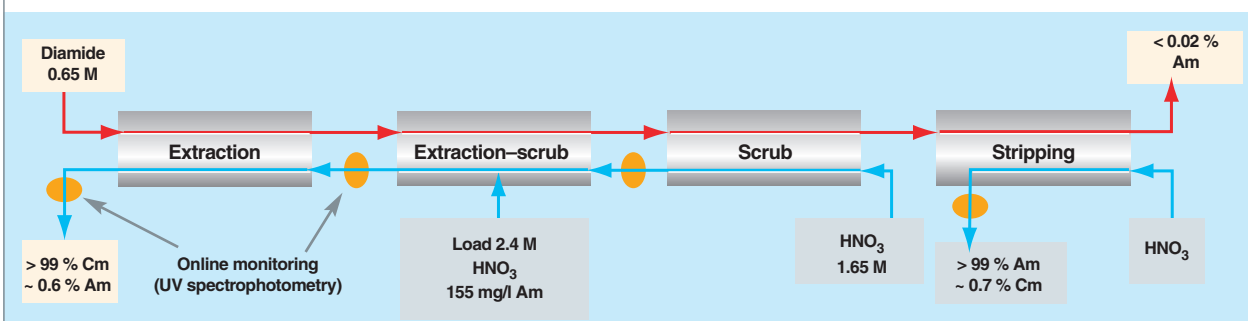
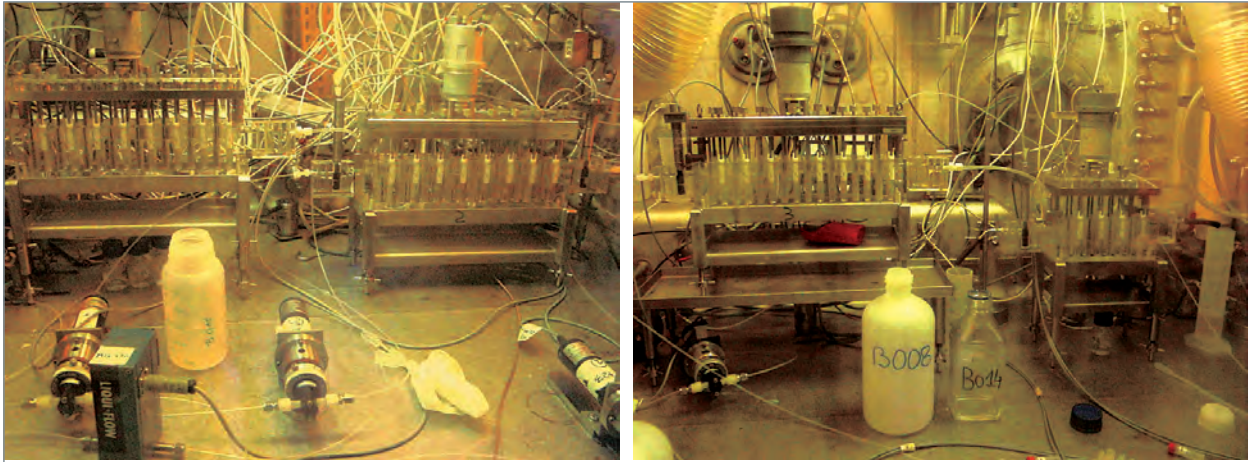

Fig. 130. View of the laboratory test, carried out in ATALANTE, of Am–Cm separation.

With regard to scale representativity, the tests were carried out, as far as feasible, in equipment analogous to that used in the La Hague plants

### The demonstration facilities

New facilities were brought on stream at Marcoule (southern France), for these demonstration tests:

- a shielded process line (CBP: *Chaîne blindée procédé*), within the ATALANTE facility, featuring a high-headroom shielded cell, fitted with pulsed columns 4 meters high, reproducing, at 1:500 scale (in terms of throughput) the technologies in use at La Hague;
- an irradiation loop, allowing solvent treatment effectiveness to be evaluated, with regard to solvent recycling within the plant;
- a chemical engineering platform, used, on the one hand, for the qualification of the equipment developed, prior to setting it up in a shielded line (CBP, for instance), and, on the other hand, to carry out inactive tests, as a preparation for high-level, and integration tests.

### The processes selected for the technical feasibility demonstration

The indirect route, in particular the DIAMEX–SANEX process, the scientific feasibility of which was demonstrated in 2001, was selected as reference pathway, for the purposes of the technical feasibility demonstration, for enhanced partitioning of the minor actinides americium, and curium.

This work was complemented by techno–economic studies, allowing an initial estimate to be arrived at, of the cost involved for an industrial enhanced partitioning workshop.

### Implementation, and overall validation of enhanced partitioning processes

Technical feasibility demonstration tests, for the DIAMEX and SANEX processes, were carried out in 2005, with a raffinate from the PUREX–Np test, involving close to 15 kg spent nuclear fuel (see the section on “Neptunium partitioning”, pp. 104–106). Experiments were carried out, as far as feasible, using technologies, and in conditions analogous to those that might be involved at the industrial scale, namely with continuous extractors (pulsed columns, in particular).

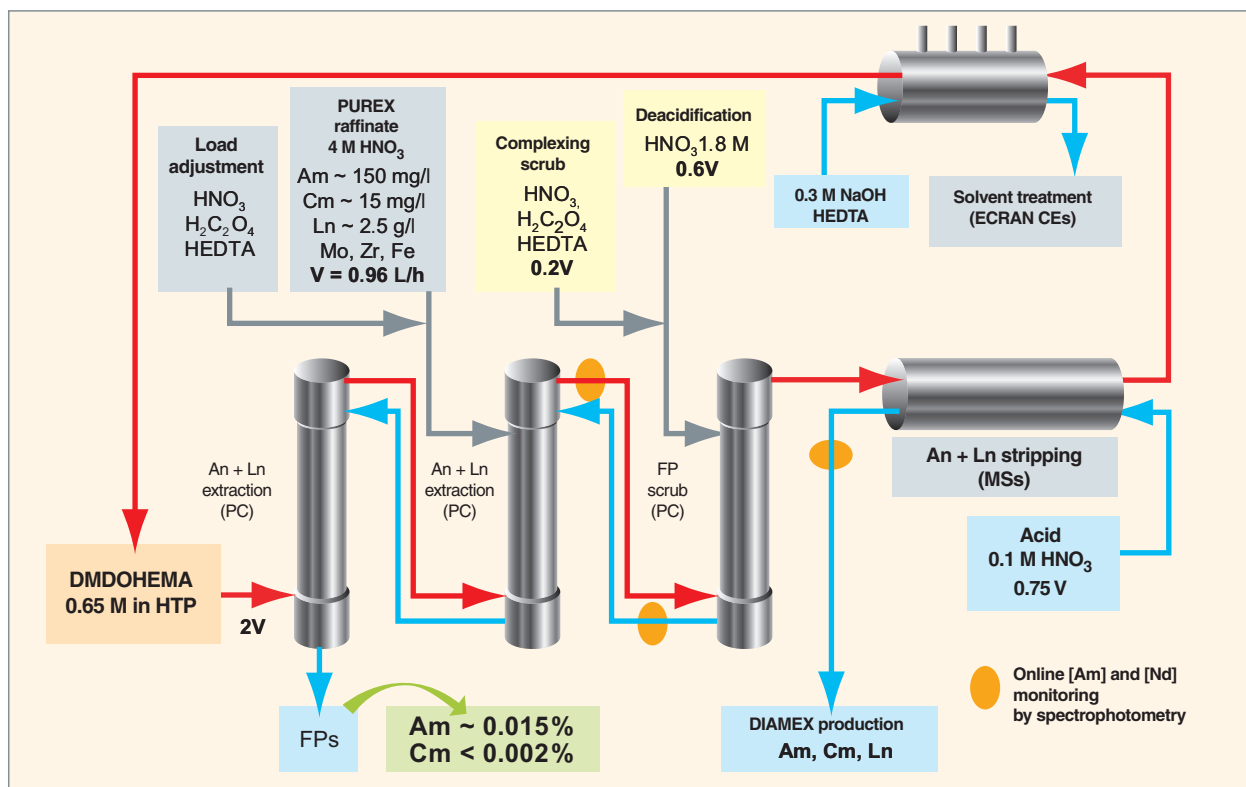

Fig. 131. Flowsheet for, and main results from, the DIAMEX demonstration test, carried out in November 2005 in the CBP line.

Thus, the equipment selected, for the demonstration of the DIAMEX process, in the CBP shielded line, comprised the following (see Fig. 131):

- two pulsed columns (PCs) (each one of 4 m working height), set up in cascade, for the extraction function;
- one pulsed column for the FP scrubbing function;
- one 8-stage mixer–settler (MS) cascade, for the stripping function;
- four centrifugal extractors (CEs) for the solvent treatment function, prior to recycling.

This choice was validated through a final, long-duration hydrodynamic functioning test, in inactive conditions, implementing the full flowsheet (options, and couplings between chemical engineering equipment units), in a configuration close to that of the CBP setup (see Fig. 132).

The test involving an actual solution, lasting some 30 hours, used 31 liters of solution – yielded by the PUREX–Np test carried out in 2005 – rich in americium, curium, and all of the fission products from the dissolved fuel.



Fig. 132. A view of the pulsed columns, set up in the shielded process line (CBP) in the ATALANTE facility, for the purposes of the technical feasibility demonstration tests for enhanced partitioning, carried out in 2005.

Hydrodynamic functioning of the equipment proved highly satisfactory, while the performance achieved complied with the targets set, i.e. Am, Cm, and lanthanide recovery rates higher than 99.9%, purification with respect to other FPs likewise proving quite satisfactory (the purification factor standing around 800 with respect to zirconium, one the more difficult elements to remove).

The SANEX process was tested in another section of the ATALANTE facility. For this test, the americium, curium, and lanthanide production solution, as yielded by the DIAMEX process test, underwent treatment in accordance with the flowsheet set out in Figure 133, using continuous liquid-liquid contactors (of the Taylor-Couette column type), and centrifugal extractors.

The configuration tested involved:

- a **high-acidity** (3–4 M HNO<sub>3</sub>) An(III) and Ln(III) **coextraction** section, using the DMDOHEMA–HDEHP extractant system, followed by solvent deacidification, using dilute HNO<sub>3</sub>, immediately upstream of the subsequent step, this requiring a very low-acidity medium;

- a **selective actinide stripping** section, using HEDTA, effected at pH 3, the lanthanides remaining extracted in the organic phase, due to the extractive properties of HDEHP, at low acidity;
- a **lanthanide scrubbing** section, for the purposes of completing lanthanide decontamination, for the stripped actinide fraction;
- a **lanthanide stripping** section, operated in the acidity domain corresponding to the minimum extraction potential, for the extractant mix;
- a **solvent purification** section, prior to recycling (see the Box “Solvent regeneration”).

The results, as regards americium and curium separation, and selective recovery, proved highly satisfactory (**about 99.9%, with purification factors standing at several tens, with respect to lanthanides**), confirming previously obtained results, though involving, this time, more complete implementation conditions (solvent treatment...).

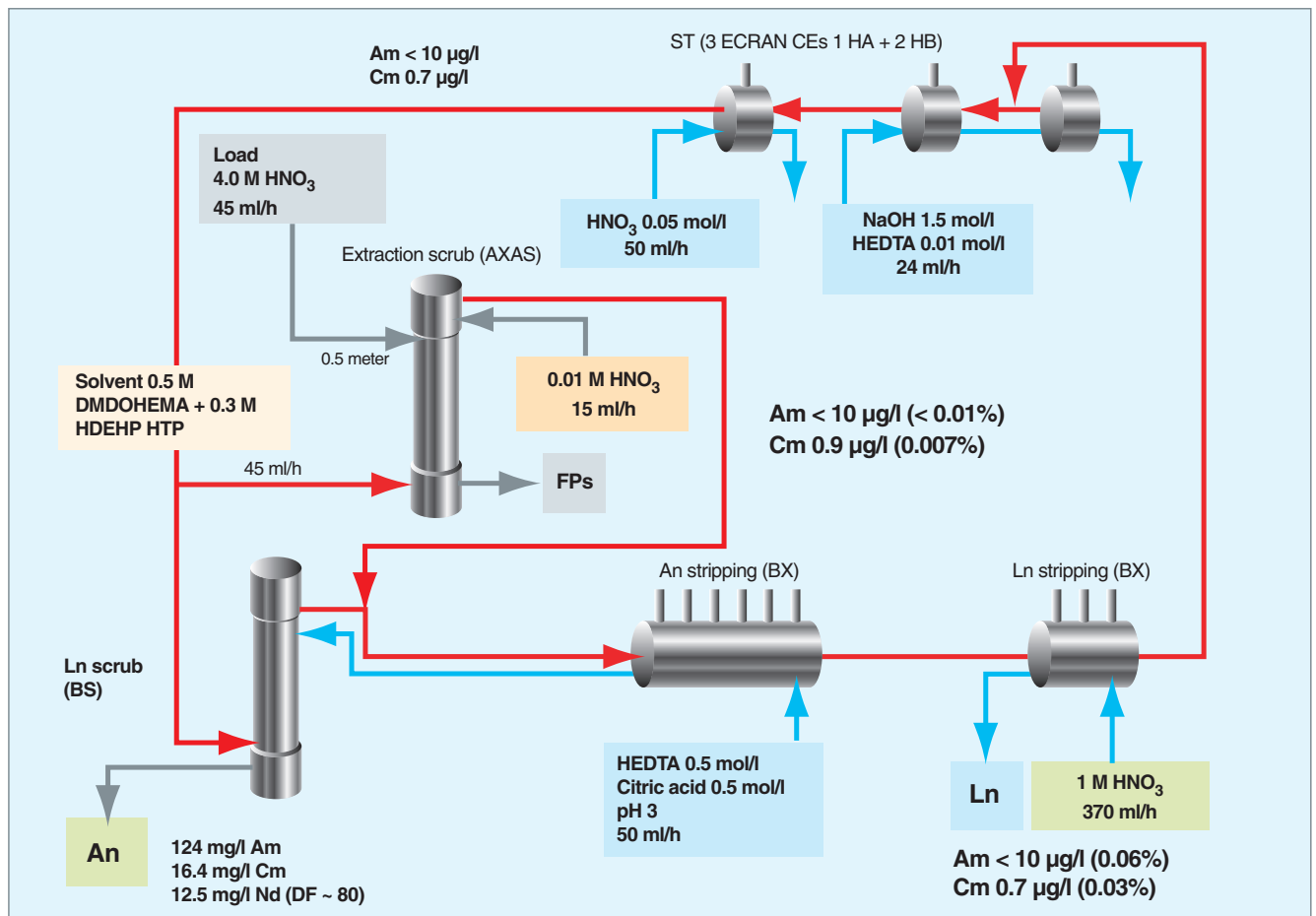

Fig. 133. Flowsheet for, and main results from, the SANEX 2005 test.

## Solvent regeneration

The extractant system used for the DIAMEX–SANEX process, consisting as it does of DMDOHEMA and HDEHP, degrades owing to hydrolysis, and the effects of irradiation (radiolysis). To ensure it can be recycled within the process, degradation products must be removed, by means of a suitable regeneration treatment. This solvent treatment step is classically carried out through contact with a basic solution.

The tests carried out in 2004 and 2005 were intended as endurance trials, with regard to radiolysis, and hydrolysis, for the DIAMEX and SANEX processes, and included continuous solvent treatment, and recycling, over durations of several hundreds of hours, equivalent, in terms of total integrated dose, to 1–2 years of cycle operation in a plant. In concrete terms, the tests involved, in particular, ascertaining there was no buildup of degradation products (owing to their removal, by basic contact), and that the solvent's chemical, and physicochemical properties were not significantly impaired. The findings obtained show that DMDOHEMA degradation rate, for an equal total dose, is two to three times higher than for TBP, while remaining sufficiently low to allow industrial use of this solvent to be considered. Carrying out solvent treatment, indeed, makes it possible to prevent a buildup of the chief acidic degradation products (see Fig. 134). The only compound liable to so build up is a malonamide, shorn of a methyl group from the nitrogen atom in one of the amide functions; this degradation product is not a problem, since it belongs to the diamide family.

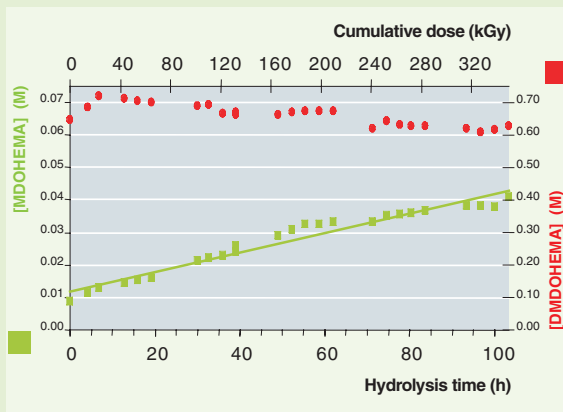

Fig. 134. Endurance trial for the DIAMEX process, carried out in the irradiation loop (total integrated dose equivalent to two years' operation for the solvent, in contact with UOX fuel). MDOHEMA, a malonamide shorn of one methyl group, does build up, however this involves no impact on the process.

## Initial design studies for an enhanced partitioning workshop

Complementing the experimental demonstration studies, techno-economic evaluations have been carried out, in partnership with the industrial operator, in order to provide an estimate of construction costs for a future enhanced, or group partitioning industrial workshop.

An initial estimate of the cost of an enhanced partitioning facility was provided, involving an uncertainty of 30–40%. This highlighted the fact that liquid effluent management stands as the most costly part (about 1/4 total costs), while DIAMEX–SANEX process operations, americium–curium separation, and active-material stream concentration operations each entail fairly similar capital costs (about 1/5 of total costs), excluding costs for conversion into endproducts. Overall capital cost, for an enhanced partitioning workshop, would be of about the same order as that for one of the high-level workshops, in the UP3 or UP2-800 plants.

## Results from, and prospects for, enhanced partitioning investigations

Enhanced partitioning of long-lived radionuclides has been the driving force for a major research effort, at CEA in particular – and more specifically in the ATALANTE laboratories, at Marcoule – but equally in the wider context of a broad, and fruitful collaboration with the French, and international scientific community.

Many avenues have been explored, chiefly in order to investigate the means of partitioning minor actinides (these being the chief contributors to the long-term potential radiotoxicity of, and decay heat in, the remaining fuel, once plutonium has been recycled) from the other constituents of spent fuel.

The results achieved, in particular those yielded by the large demonstration experiments carried out in 2005, in ATALANTE, stand as a major technical advance, as called for by Direction 1, in the French Act of 30 December 1991, as regards the technical, and scientific evaluation of minor actinide partitioning, to allow for their possible transmutation.

The very many results obtained, together with the positive outside assessments of the research carried out, contributed to such investigations being carried through, under the new French Act on radioactive waste management, as promulgated on 28 June 2006.

Under the new Act of 2006 on sustainable long-lived waste management, investigations on partitioning are now to be carried out in close connection with those on Generation-IV reactors, these being particularly well suited to actinide transmutation.

The next major milestone will be in 2012, when evidence must be provided, allowing the main technological option to be decided, with respect to recycling. By that time, two main recycling options will have to be evaluated (see Fig. 135):

- homogeneous recycling, whereby actinides are diluted across the entire (U,Pu)O<sub>2</sub> driver fuels in the reactor fleet. Group partitioning meets the requirements for this option;
- heterogeneous recycling, whereby actinides are recycled by being concentrated in blankets, positioned at the core periphery, in part of the reactor fleet. Enhanced partitioning fits into this strategy.

Investigations are thus being carried forward, along both paths [11]. Enhanced partitioning feasibility being a settled issue, the point will be to extend in-depth understanding of such aspects as effluent management/destruction, and extractant synthesis; and to optimize, and simplify those processes selected as reference. One avenue for improvement is the single-cycle DIAMEX–SANEX process (rather than the two-cycle version, as carried out in 2005). Another, less costly molecule from the synthetic diamide family could result in a simpler process. These new pathways will be tested in the CBP shielded line, in 2008–2009. After which, the most promising route will be consolidated, from 2010 on, so that as many elements as possible are available, to be included in the dossier presented in 2012, on the options for transmutation.

## Cesium separation processes

After 5 years' cooling, 1 tonne spent UOX fuel, discharged at 60 GWd/tiHM, contains about 4.6 kg cesium (including 1.89 kg Cs 133, a stable isotope; 50 g Cs 134 [half-life: 2 years]; 769 g Cs 135 [half-life: 2.3 million years]; and 1.93 kg Cs 137 [half-life: 30 years]), this element contributing, together with strontium, the major part of the decay heat released, and further contributing to the various emitted radiation fluxes. On these grounds, the prior removal of cesium, from vitrified waste packages, would facilitate disposal of such packages in geological formations.

After the first 100 years or so, fission products – even the more abundant ones, such as cesium – no longer make anything more than a marginal contribution to the radiotoxicity of vitrified waste, designated for deep geological disposal. However, modeling studies have highlighted the fact that the first radionuclides to reach the biosphere, after several hundreds of thousand years, could be certain fission products, cesium in particular. While the possible impact of cesium on the biosphere lies well below the regulatory dose limits, this element has nonetheless been taken into consideration (along with iodine, technetium, and the three minor actinides Np, Am, Cm) for the “enhanced partitioning” strategy provided for in the French Act of 30 December 1991.

CEA's Cadarache Center has conducted, since the 1980s, an intensive research effort on cesium separation, involving high-level effluents, provided either by effluents arising from nuclear energy activities (e.g. water from irradiated fuel storage pools, installation rinsing water, salt-laden evaporation concentrates, etc.), or by spent nuclear fuel treatment (e.g. PUREX raffinates containing fission products, activation products, and minor actinides).

The hydrometallurgical techniques investigated involved, successively: (i) precipitation (deployed at the industrial scale, in liquid effluent treatment plants); (ii) chromatographic separation (using e.g. ion-exchange resins for storage pool water, or functionalized silicas); (iii) zeolite adsorption; and (iv) solvent extraction (or liquid–liquid extraction), this technology proving more compatible with a continuous spent nuclear fuel treatment process.

Solvent extraction of alkali metal cations is an area that is widely covered in the literature [12]. Investigations do however emphasize the difficulty involved in selective cesium extraction from highly acidic solutions, chiefly when in the presence of other alkali metal elements, such as sodium (originating, as a rule, in the sodium hydroxide neutralization of acidic industrial nuclear effluents).

In aqueous solution, cesium is a “hard” acid, in Pearson's sense: it will thus undergo strong interaction with “hard” bases, such as anions or molecules featuring fluorine or oxygen

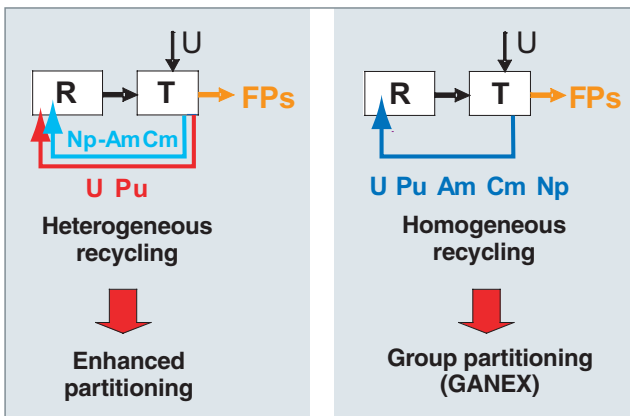

Fig. 135. The chief options for minor actinide recycling in Generation-IV reactors.

atoms, acting as electron donors, and favoring electrostatic interactions.

The first extractants to be considered at CEA were the crown ethers, or macrocyclic polyethers, discovered by C. J. Pedersen in 1967. Parameter studies of alkali metal cation extraction by crown ether compounds showed that the quantities of metal cations extracted to the organic phase depended on the following factors: the nature of the organic diluent in which the crown ether is dissolved; nature of the anion associated to the alkali metal cation; size of the cavity provided by the crown ether, relative to the metal cation's diameter; chemical composition of the (aqueous, and organic) phases in contact; nature of the groups attached to the crown ether skeleton; and pH of the aqueous extraction solution, should the crown ether feature an acid function.

The most suitable crown ether, for the purposes of cesium extraction, is di-(*tert*-butylbenzo)-21-crown-7 (*t*-Bu-Bz-21C7: see Fig. 136), as it features 7 oxygen atoms (the size of its cavity proving a good fit for the cesium atom), while its lipophilic character promotes cesium nitrate extraction in aromatic diluents (owing to the presence of two *tert*-butylbenzene groups). However, its selectivity with respect to cesium, in the presence of other alkali metal cations, is poor.

The development of a cesium extraction process, to achieve the target 99.9% cesium recovery, thus required developing novel molecules, affording the ability to act as more effective, and more selective cesium complexants: the calixarenes (see the Box “Calix[4]arene-crown-6 ethers, the foundation for the cesium separation process”). These are macrocyclic molecules, featuring from four to eight phenolic groups, cyclized by methylene groups (see Fig. 137), which may be functionalized on the “lower side” (i.e. the hydroxyl side), or “upper side” (the *tert*-butyl side).

The synthesis, and characterization of the calixarenes investigated at CEA were mainly carried out under the aegis of European research programs.

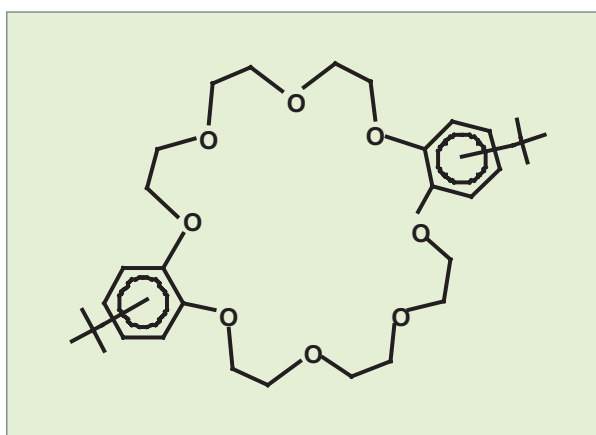

Fig. 136. Di-(*tert*-butylbenzo)-21-crown-7 (*t*-Bu-Bz-21C7).

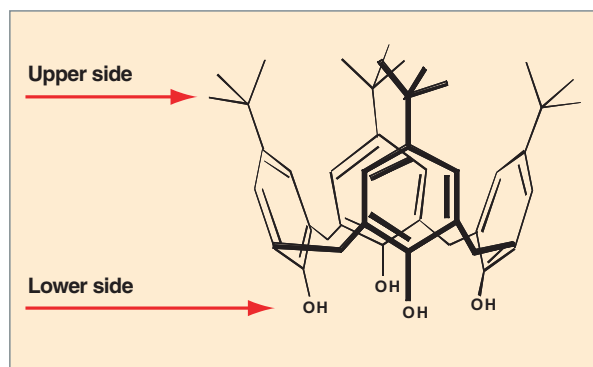

Fig. 137. A calixarene molecule.

Subsequent to basic data acquisition, flowsheet computations were carried out, with both of the systems being considered (see Fig. 138). Countercurrent tests were carried out, with simulated solutions, using centrifugal extractors and Couette-type laboratory columns, to minimize the volumes of solution involved, and subsequently in 15-mm diameter pulsed columns. Using centrifugal extractors, cesium extraction and back-extraction rates higher than 99.9% were achieved, consistent with predictions. Tests involving columns (whether of the pulsed, or Couette type) showed a satisfactory hydraulic functioning, for both solvents tested. However, a more strongly emulsifying behavior was found for calix[4]arene-crown-6 molecule “R14.”

Such positive findings led to the testing, for each solvent, of a complete flowsheet, using a DIAMEX process raffinate, in the ATALANTE facility. The extraction and recovery percentages achieved for cesium are quite high: 99.9%; while selectivity with respect to all other elements is outstanding: this demonstrating the scientific feasibility of selective cesium recovery by calix[4]arene-crown-6 molecules. In spite of such excellent performance, cesium separation processes were not submitted for technical feasibility demonstration tests, since in-reactor transmutation of cesium is scarcely to be entertained (see the chapter on “Radionuclide management strategies”, pp. 151–153), and is not being considered in the newly adopted long-lived waste management strategy.

## Group partitioning of actinides

The GANEX (Group Actinide [An] Extraction) concept, the principle of which is set out in Figure 139, has been developed for the purposes of homogeneous, in-reactor actinide recycling. The process is based on a selective uranium separation step, at the head end, followed by the group partitioning of transuranium elements (Np, Pu, Am, Cm).

## Calix[4]arene-crown-6 ethers, the foundation for the cesium separation process

The bridge set up, by an ether function, between two diametrically opposed hydroxyls in a calix[4]arene in 1,3-alternate configuration enhances the extraction power, and, most crucially, the selectivity exhibited by crown ethers, and calixarenes, with respect to cesium. Thus, calix[4]arene-crown-6 ethers, featuring 6 oxygen atoms in their crown, soon proved themselves as having a high ability to extract cesium from acidic, and salt-laden media, while exhibiting better Cs/Na selectivity than conventional systems.

Initial operations using calix[4]arene-crown-6 ethers involved a polar diluent, nitrophenyl hexyl ether, this exhibiting thermodynamic properties that would not allow direct transposition to an industrial liquid-liquid extraction process. To ensure that the nature of the organic diluent used be more compatible with the PUREX process, investigations were carried out, to achieve calix[4]arene-crown-6 dissolution in hydrogenated tetrapropylene (HTP), through the addition of a modifying agent, increasing HTP polarity. The two solvents selected are shown in Figure 138.

The first solvent involves the “octyl” calix[4]arene-crown-6; the modifier used is TBP, which does have the drawback of also extracting zirconium (this requiring the introduction of oxalic acid into the load subjected to treatment). The second solvent uses the “R14” calix[4]arene-crown-6, the modifier being a monoamide that does not carry the drawback involved by TBP.

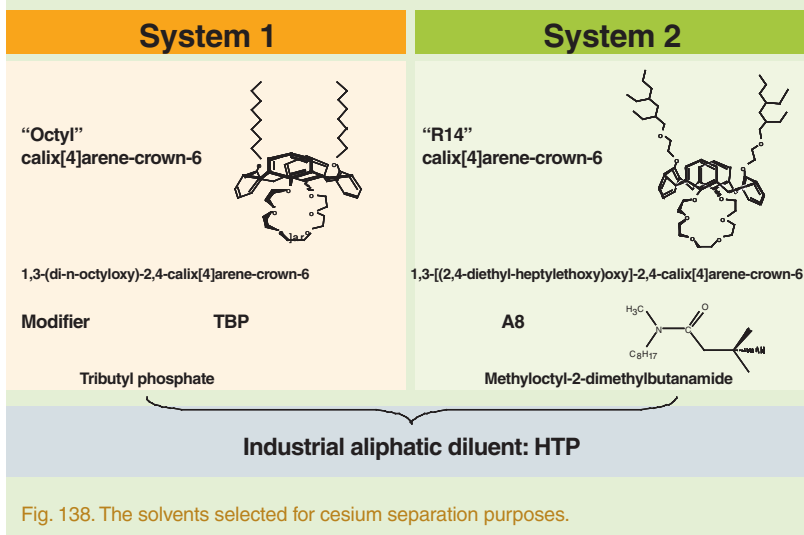

Fig. 138. The solvents selected for cesium separation purposes.

## Preliminary uranium separation

Selective uranium extraction relies on the use of extractant molecules from the monoamide family,  $RC(O)NR'_2$ . Such molecules, already investigated, at CEA, in the 1980s and 1990s, as alternatives to the TBP solvent, in the PUREX process [13], act as powerful actinide(VI) extractants, in particular with regard to uranium, from concentrated nitric solutions. By modifying the structure of such monoamides, their extractant properties may be optimized. Indeed, appending a branched alkyl substituent, R, onto the carbon atom located at the a position, in the carbonyl function, ensures enhanced U(VI)/Pu(IV) selectivity, even at high nitric acidity, while attaching branched R' alkyl substituents to the nitrogen atom in the amide function improves the extractant's loading capacity (the maximum quantity of elements that can be extracted to the organic phase). Such optimized molecules have the ability to effect the selective extraction of uranium, without requiring any addition of plutonium(IV) complexing, or reducing reactants.

The DEHiBA [*N,N*-di(2-ethylhexyl) isobutyramide] molecule, as shown in Figure 140, was selected, from various monoamides meeting this selectivity criterion, on the following grounds:

- it involves a satisfactory compromise between quantitative uranium extraction, and good U(VI)/Pu(IV) selectivity;

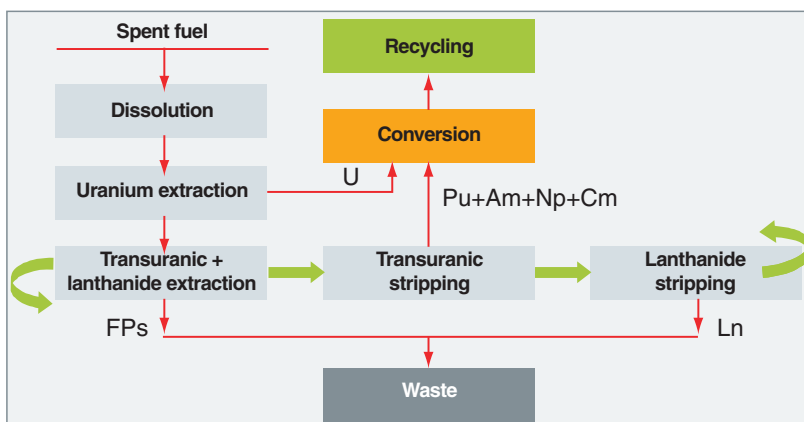

Fig. 139. Principle flowsheet for the GANEX process.

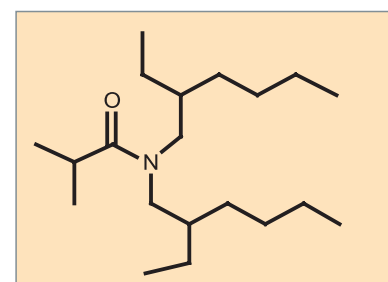

Fig. 140. Structure of DEHiBA.



- high uranium/fission product decontamination factors (at least equal to, or even higher than those achieved with BTP);
- high solubility in the aliphatic diluents used in industrial spent fuel treatment operations (dodecane, Hyfrane, HTP);
- adequate loading capacity for the DEHiBA–HTP extractant system, with regard to the quantities of uranium to be extracted (about 200g/l uranium being present in the dissolution solution);
- low extractant solubility in the aqueous phase;
- acceptable synthesis costs, with regard to industrial deployment of the process.

The development methodology, for any process, requires an initial phase involving the acquisition, in the laboratory, of large amounts of data concerning the extraction of elements of interest (uranium, nitric acid, plutonium, fission products), with the selected extractant system (see the Box “Modeling monoamide extraction”, below), in order to model, subse-

quently, the various extraction equilibria that may serve in the computation of separation flowsheets, to be validated experimentally.

After integrating such a model into the PAREX process simulator, an initial flowsheet, involving three mixer–settler cascades, was tested (see Fig. 143).

At the outcome of this test, **a uranium recovery rate higher than 99.9% was achieved**, demonstrating the outstanding extractant performance exhibited by this monoamide, with respect to uranium, and the feasibility of using it in batch liquid–liquid contactors. Experimental profiles, in equilibrium conditions, of nitric acid concentrations (see Fig. 144), and uranium concentrations (see Fig. 145), in each phase, were compared with computed profiles. The good agreement between experimental, and computed values confirms the relevance of the model developed. This model has now been completed, with the distribution data for plutonium(IV), neptunium(V, VI), and technetium(VII), for the purposes of dimensioning the purification step, for the uranium-loaded solvent (solvent scrub).

### Modeling monoamide extraction

**Distribution coefficients\*** for uranium(VI) and nitric acid were measured at various nitric acidities, for a variety of uranium concentrations in a 1 M DEHiBA–HTP solvent, to cover the ranges of nitric acid, and uranium concentrations involved in the various steps in the process. On the basis of these experimental data, it was possible to model the extraction equilibria involved in the U(VI)–HNO<sub>3</sub>–DEHiBA system.

Representation of uranyl nitrate extraction is achieved by taking into consideration a single species, involving two monoamides for one uranyl ion: [UO<sub>2</sub>(NO<sub>3</sub>)<sub>2</sub>(DEHiBA)<sub>2</sub>]. As occurs with TBP, the uranyl ion should be extracted in accordance with the solva-

tion mechanism represented by the equilibrium set out below. Uranium would enter into a complex with two nitrate ions (to balance the uranyl ion’s charge), and two monoamide molecules, most likely positioned along the uranyl ion’s equatorial plane (see Fig. 141):



A comparison of experimental extraction data, and values computed with this model is set out in Figure 142, as regards uranyl nitrate extraction.

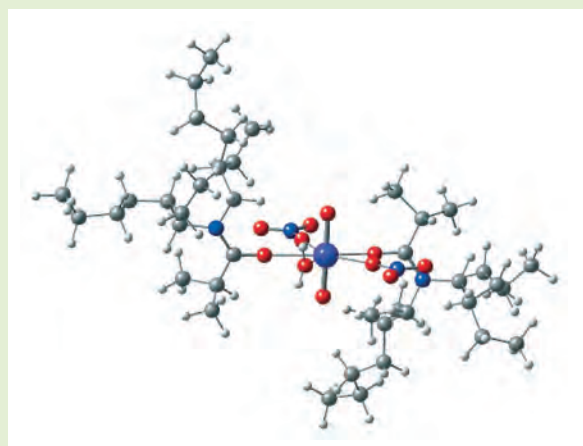

Fig. 141. Molecular representation of the [UO<sub>2</sub>(NO<sub>3</sub>)<sub>2</sub>(DEHiBA)<sub>2</sub>] complex.

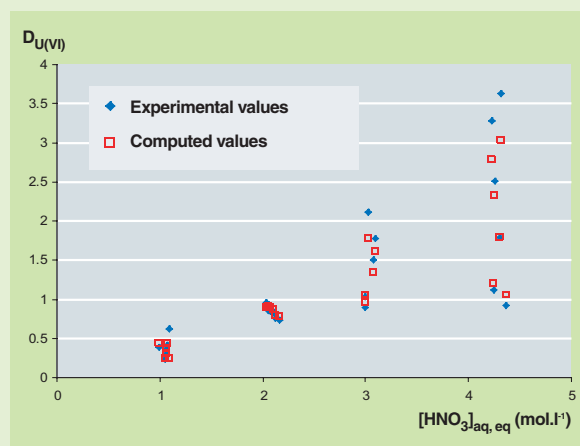

Fig. 142. Comparison of experimental, and computed uranium(VI) distribution coefficients, with the 1 M DEHiBA–HTP solvent, at 25 °C.

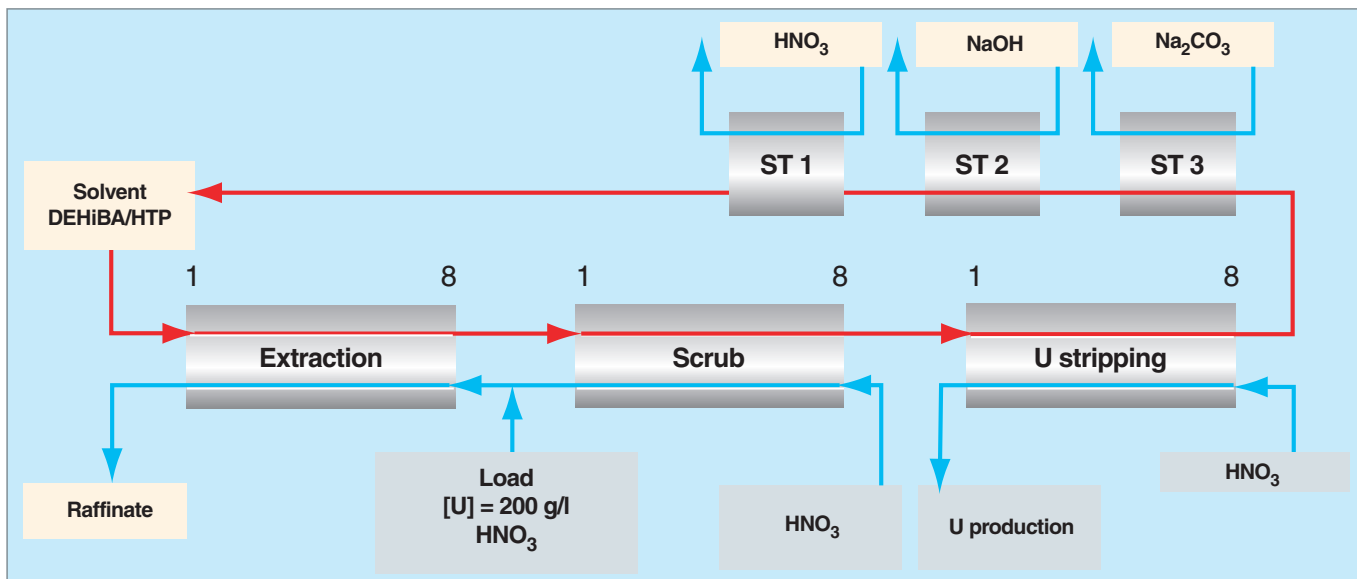

Fig. 143. Flowsheet for the monoamide separation process.

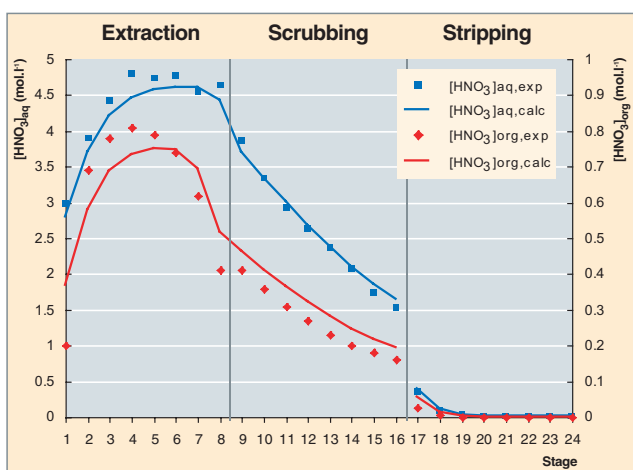

Fig. 144. Comparison of experimental, and computed nitric acid concentration profiles for the various stages involved in the process.

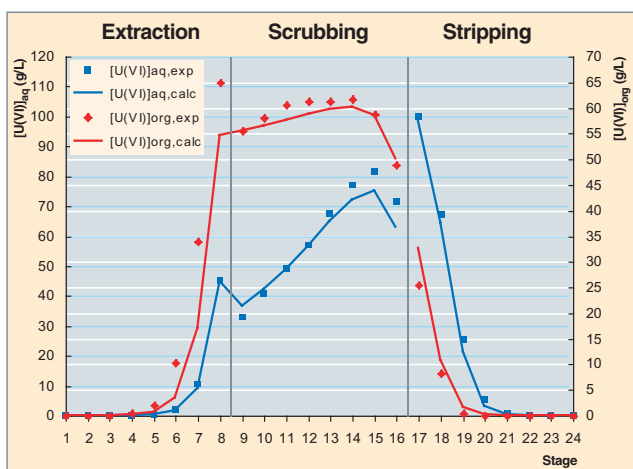

Fig. 145. Comparison of experimental, and computed uranyl nitrate concentration profiles for the various stages involved in the process.

The flowsheet is designed to effect more than 99.9% separation of uranium, yielding an actinide stream of sufficient purity, with respect to fission products, not to require a second purification cycle. This uranium stream, after reduction to uranous nitrate – U(IV) – is to be recycled upstream of the coconversion step, for the fabrication of actinide-bearing fuel.

At this preliminary qualification stage, endurance tests of this monoamide, with regard to hydrolysis, and radiolysis\*, lasting 700 hours – simulating a solvent residence time, in contact with an irradiating medium, of about 2 years – is under way, involving the identification of the degradation products formed, and research on the conditions for their removal from the solvent, prior to recycling (development of the appropriate solvent treatment).

### The GANEX cycle proper: group partitioning of actinides (Np, Pu, Am, Cm)

Uranium having been separated in an initial cycle, the remaining actinides (Np, Pu, Am, Cm, and uranium traces in the raffinate) are partitioned from fission products in a second extraction cycle. The specific character of such group partitioning, and the challenge it involves chiefly concerns the process's capability, as regards management of actinides:

- in a variety of oxidation states, in a nitric solution:  
+III (Am, Cm), +IV (Np, Pu), +V (Np), +VI (U, Np);
- at high concentration, in the raffinate solution yielded by the monoamide process.

Indeed, since plutonium and americium will account for some 20%, by mass, of the fuels of the future, at end of life, these elements, plutonium in particular, will be present in high concentrations in the spent fuel dissolution solution (up to 0.1 mol/l actinides). The extractant system employed must therefore have the ability to:

- extract actinides in their various oxidation states, to limit the requirement for use of redox agents;
- exhibit an adequate extraction loading capacity, to avoid calling for excessive amounts of organic extractant;
- exhibit hydrolysis, and radiolysis resistance at least equal to that of TBP (the extractant used in the PUREX process), and the DMDOHEMA malonamide (the extractant used in the DIAMEX process).

An investigation of the potential afforded by actinide separation processes, and the various extractant molecules suitable for group actinide separation was carried out in 2004. Of the various possible candidates, the DMDOHEMA–HDEHP–HTP extractant system, initially developed, and tested for the purposes of minor actinide (Am, Cm) partitioning [14], was selected, owing to its robustness, as reference pathway, for the group partitioning of actinides. The malonamide, DMDOHEMA, allows the extraction of actinides and lanthanides at high acidity, while the extractant acid, HDEHP, is there to keep the lanthanides in the organic phase, when actinides are selectively stripped to the aqueous phase, at low acidity (pH 2–3), by means of a selective aqueous complexant, effective in a high-pH medium (HEDTA).

Extending this process, to cater for group actinide extraction, entails seeking the conditions for a joint management of plutonium, and neptunium, together with minor actinides(III), in domains of much higher concentration than those involved in the initial process, while not altering separation performance. Research work has been directed at investigating actinide behavior, in the main steps involved in the process (extraction, management of extractable fission products, stripping), but equally the impact of actinides (plutonium, in particular) with regard to hydrodynamics, and the separation of fission products.

Investigations have shown that the HDEHP–DMDOHEMA–HTP extractant system ensures, by contrast to conventional extractants, quantitative actinide extraction, regardless of oxidation state in solution, provided that the medium's nitric acidity be higher than 3 mol/l [4]. In this acidity domain, neptunium(V) exhibits the specific property of undergoing **disproportionation\*** to Np(IV), and Np(VI), i.e. to species extractable to the organic phase.

Solvent loading capacity, a major consideration when selecting a process, meets specifications, to wit accommodating a

concentration of around 0.1 mol/l metal cations in the solvent (including 0.05 mol/l plutonium), without any hydrodynamic issue being observed (phase demixing) [15].

The extractant molecules' resistance to hydrolysis, and radiolysis has already been tested, in the context of investigations on enhanced partitioning. The findings showed that the solvent undergoes little radiolytic degradation. On the other hand, the chief degradation product formed, the acid amide yielded by section of the malonamide, may build up in the solvent, if not removed by the solvent treatment process.

As regards actinide recovery in the aqueous phase, investigations have shown that joint back-extraction of all actinides (Np, Pu, Am, Cm) occurs in quantitative manner, being selective with respect to extractable fission products (Ln, Y, Zr, Fe). A reducing agent is nonetheless required, to strip neptunium in Np(IV) and Np(V) form to the aqueous phase. While neptunium, and plutonium are more readily stripped, in thermodynamic terms, than minor actinides(III) (Am, Cm), on the other hand they do involve slower back-extraction kinetics. Further investigations, however, showed that actinide back-extraction kinetics is temperature-sensitive. Indeed, an increase in temperature from 23 °C to 45 °C allows a gain by a factor 3 to be achieved, as regards neptunium and plutonium back-extraction rates. Such rates then become compatible with implementation of the process in standard liquid–liquid contactors (mixer–settlers, or centrifugal extractors). The flowsheet applicable, for the purposes of group partitioning of actinides, is set out in Figure 146.

At this stage in the investigations, no unacceptable issue has emerged. On the contrary, the results obtained are encouraging enough, to allow a scientific feasibility demonstration of the group partitioning of actinides to be considered, as early as 2008, to be carried out in ATALANTE, involving a spent fuel dissolution solution.

## ► References

- [1] Y. ZHU, J. CHEN and R. JIAO, "Extraction of Am(III) and Eu(III) from nitrate solution with purified Cyanex 301", *Solvent Extraction and Ion Exchange* 14, 1996, pp. 61–68.
- [2] C. MADIC, M.J. HUDSON, J-O. LILJENZIN, J.-P. GLATZ, R. NANICINI, A. FACCHINI, Z. KOLARIK, R. ODOJ, "New partitioning techniques for minor actinides", NEWPART (New Partitioning Techniques [FP4]), Final Report, EUR19149en, European Commission, 2000.
- [3] PARTNEW: Partitioning: New Solvent Extraction Processes for Minor Actinides, Integrated Project No. FIKW-CT-2000-00087, steered by CEA, Marcoule Center, under the aegis of the 5th Framework Program (FP5), European Commission, 2000–2003.
- [4] ZDENEK KOLARIK, U. MÜLLICH and F. GASSNER, "Selective extraction of Am(III) over Eu(III) by 2,6-ditriazolyl- and 2,6-ditriazinylpyridines", *Solvent Extraction and Ion Exchange* 17, 1999, pp. 23–32.

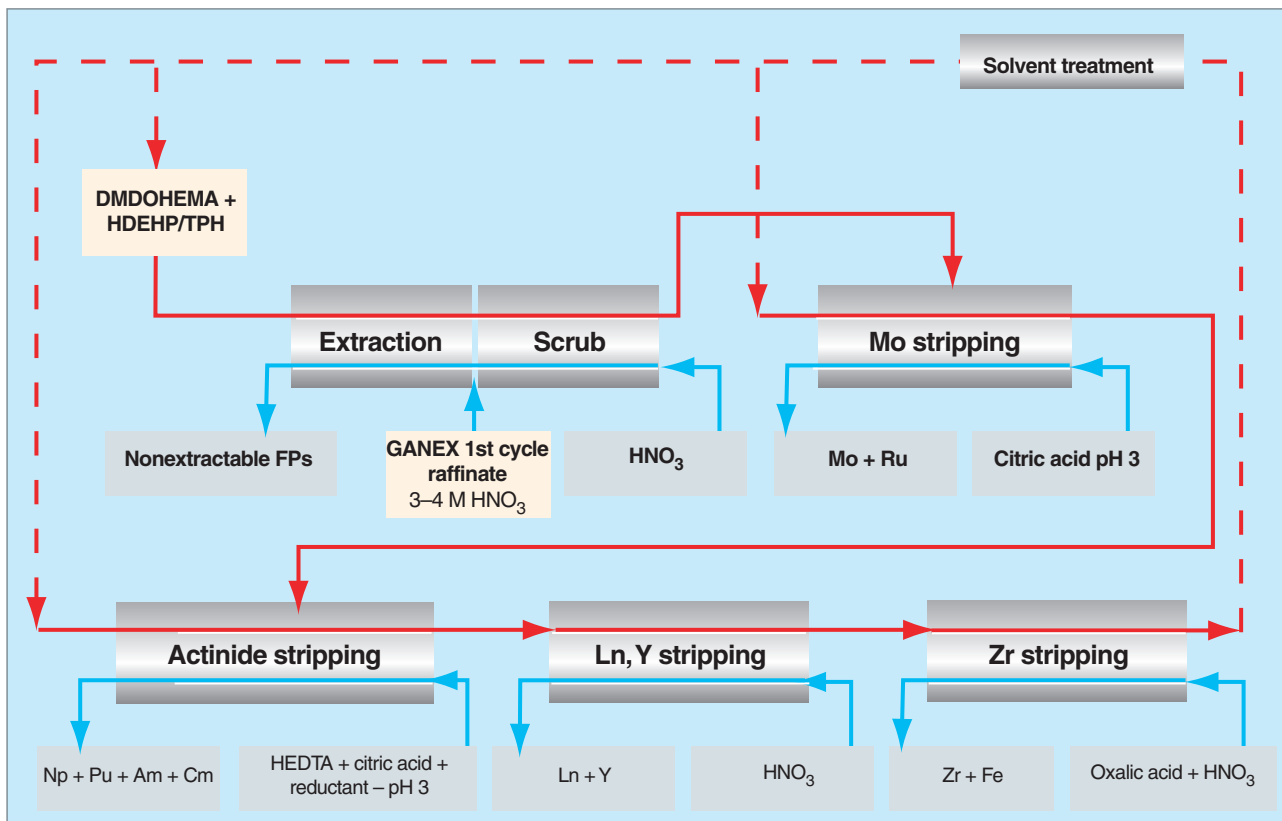

Fig. 146. Detailed flowsheet for the DIAMEX–SANEX group actinide partitioning process.

[5] EUROPART: European Research Programme for the Partitioning of Minor Actinides, Integrated Project No. 508854, steered by CEA, Marcoule Center, under the aegis of FP6, European Commission, 2003–2007.

[6] L. MARTINET, *Organisation supramoléculaire des phases organiques de malonamides du procédé d'extraction DIAMEX*, doctoral dissertation, Paris-XI–Orsay University, 15 April 2005; CEA Report CEA-R-6105, 2006.

[7] J.-L. FLANDIN, *Approche calorimétrique de la complexation et de l'extraction des lanthanides(III) par les malonamides*, doctoral dissertation, Clermont-Ferrand-II–Blaise-Pascal University (France), 27 October 2000; CEA Report CEA-R-5978, 2001.

[8] F. GUTIERREZ, *Étude théorique des états excités de grandes molécules*, doctoral dissertation, Toulouse-III–Paul-Sabatier University (France), 12 November 2002.

[9] N. FRANÇOIS, *Vers une interprétation des mécanismes de la séparation actinides(III) / lanthanides(III) par extraction liquide–liquide synergique impliquant des ligands polyazotés*, doctoral dissertation, Nancy-I–Henri-Poincaré University (France), 6 October 1999; CEA Report CEA-R-5902, 2000.

[10] Manuel MIGUIRDITCHIAN, *Étude thermodynamique de la complexation des ions actinide(III) et lanthanide(III) par des ligands polyazotés en milieu homogène*, doctoral dissertation, Paris-XI–Orsay University, 12 December 2003; CEA Report CEA-R-6059, 2004.

[11] P. BARON, M. MASSON, C. ROSTAING, B. BOULLIS, “Advanced separation processes for sustainable nuclear systems”, GLOBAL 2007: *Advanced Nuclear Fuel Cycles and Systems*, Boise, Idaho (USA), 9–13 September 2007.

[12] B. A. MOYER and Y. SUN, “Principles of solvent extraction of alkali metal ions: Understanding factors leading to cesium selectivity in extraction by solvation”, in J. A. MARINSKY and Y. MARCUS (eds.), *Ion Exchange and Solvent Extraction*, vol. 13, Marcel Dekker Inc., 1997, Chap. 6, pp. 295–391.

[13] N. CONDAMINES, *Contribution à l'étude de l'extraction d'acides minéraux et de cations actinides aux degrés d'oxydation (IV) et (VI) par des N,N-dialkylamides*, doctoral dissertation, Paris-VI–Pierre-et-Marie-Curie University, 1989; CEA Report CEA-R-5519, 1990.

[14] P. BARON, X. HERES, M. LECOMTE and M. MASSON, “Separation of minor actinides: the DIAMEX–SANEX concept”, GLOBAL 2001: *Back-end of the Fuel Cycle: From Research to Solutions*, Paris (France), 9–13 September 2001.

[15] M. MIGUIRDITCHIAN, L. CHAREYRE, X. HERES, P. BARON and M. MASSON, “GANEX: Adaptation of the DIAMEX–SANEX process for the group actinide separation”, GLOBAL 2007: *Advanced Nuclear Fuel Cycles and Systems*, Boise, Idaho (USA), 9–13 September 2007, American Nuclear Society, pp. 550–552.

## ► Bibliography

CEA (Collective), *Base de données sur les radionucléides à vie longue (RNVL)*, CEA Working Group Report CEA-R-6026, 2003.

CEA (Collective), *Les Déchets radioactifs à haute activité et à vie longue: Recherches et résultats – Loi du 30 décembre 1991 – Axe 1: Séparation et transmutation des radionucléides à vie longue*, Final Report, CEA Report CEA/DEN/DDIN/2005-568, December 2005.

CEA/DEN (Collective), “Programme de recherches du CEA dans le cadre de la loi du 28 juin 2006”, CEA Report DDIN/DPCD/2007-50, 2007.

COMMISSION NATIONALE D'ÉVALUATION DES RECHERCHES SUR LA GESTION DES DÉCHETS RADIOACTIFS (French National Assessment Commission on Radioactive Waste Management Research), “Rapport global d'évaluation”, January 2006.

MINISTÈRE DE LA RECHERCHE - DIRECTION DE LA TECHNOLOGIE (Technology Directorate, French Ministry of Research), *Stratégie et programmes des recherches au titre de l'article L. 542 du code de l'environnement, issu de la loi du 30 décembre 1991*, April 2001.

NEA, *French R&D on the Partitioning and Transmutation of Long-Lived Radionuclides. An International Peer Review of the 2005 CEA Report*, NEA No. 6210, OECD, 2006.

*Radioactive Waste: Constant Advances with Solutions*, Clefs CEA No. 53, Winter 2005–2006, ISSN 1625-970X (CD-ROM).

B. BOULLIS, “Séparer les éléments radioactifs à vie longue: les acquis de 15 années de recherches, des molécules aux procédés”, *Revue générale nucléaire*, 2006, No. 2, pp. 38–45.

C. MADIC, M. J. HUDSON, *High level liquid waste partitioning by means of completely incinerable extractants*, Report EUR18038en, European Commission, 1998.

C. MADIC, F. TESTARD, M. HUDSON, J.-O. LILJENZIN, B. CHRISTIANSEN, M. FERRANDO, A. FACCHINI, A. GEIST, G. MODOLO, A. GONZALES-ESPERANTO, J. DE MENDOZA, PARTNEW: Partitioning: New Solvent Extraction Processes for Minor Actinides, Final Report (Integrated Project No. FIKW-CT-2000-00087 [FP5]), European Commission, EURATOM, 2004.

**Christine ROSTAING, Binh DINH, Clément HILL,**  
**Denis GUILLANEUX, Manuel MIGUIRDITCHIAN,**  
*Radiochemistry and Processes Department*



## Actinide conversion

### The new challenges set by actinide coconversion

Once they have been separated, actinides must be converted into a chemical form suitable for their subsequent utilization. Separate conversion of uranium, and plutonium, as yielded by the PUREX process, is currently carried out on an industrial scale. For the near future, consideration is being given to the joint conversion of uranium and plutonium.

Further out in the future, fuel cycles will doubtless involve group management of actinides, and the recycling of minor actinides, as an alternative to their confinement in ultimate waste. Group coprecipitation of all of the actinides (U, Pu, Np, Am, Cm) is being considered as the chief option, for the purposes of carrying out coconversion. Other alternatives are also being investigated, such as cogelation, or codenitration.

The solution yielded by spent fuel treatment operations involves a *mixture of actinides*, in concentrations that may, at the same time, span 3 or 4 orders of magnitude, this possibly entailing significant complications, as regards achieving quantitative immobilization of the actinides, in the solid precipitate phase.

Uranium, neptunium, and plutonium may exhibit a variety of oxidation states, in solution, making for a multiplicity of possibilities, with respect to their coimmobilization, within a solid phase, in diverse oxidation states (see Fig. 147). Americium, and curium most commonly occur in oxidation state +III only – this, for ammonium hydroxide or sol–gel-type processes, calling for highly basic pH values (pH > 7); while it does nar-

row down, as regards processes involving precipitation as a whole, the options, as to possible ligands.

The first step entailed by coconversion thus involves stabilizing the mixture of actinides, in those oxidation states for which their reactivity is so adjusted that reactions will be as simultaneous as feasible, in the presence of the anion that induces their insolubilization. The challenge, indeed, is to obtain a solid phase containing all of the actinides involved, i.e. a mixed solid phase, of controlled composition, within which actinide distribution will be as homogeneous as possible, to preclude any phase segregation in subsequent steps. In practice, actinide mixtures in solution are stabilized in a single oxidation state, provided this may be readily effected; or, failing this, in distinct oxidation states, involving however target reactivities as closely similar as feasible, in the chemical system considered [1].

If the homogeneous actinide multirecycle option is being considered, however, there can be no question of any stabilization being achievable, in one and the same oxidation state, in an aqueous solution, of a mixture of uranium, plutonium, neptunium, and americium, and/or curium, owing to the distinct inherent physicochemical properties exhibited by each of these actinides.

Owing to their redox properties, uranium and plutonium, when mixed in an aqueous nitric acid solution, most commonly occur, respectively, in oxidation states VI, and IV; or IV, and III in a reducing medium. Concurrent management of neptunium with uranium, and/or plutonium entails that this minor actinide be stabilized in oxidation states IV, or VI, since oxidation state V may result in incomplete incorporation into the solid phase,

during coconversion, due to insufficient reactivity. A similar approach, applied to americium and/or curium, entails the coconversion of a dissolved U(VI) + Pu(IV) + Am,Cm(III) mixture; or, after reduction, and stabilization, of a U(IV) + An(III) mixture, where An = Pu, Am, and/or Cm.

Actinide redox properties are likewise at work in the solid phase, making for significant complications, as regards controlling the transformations of the coprecipitate, gel, or other intermediate phase, through to the coconversion endproduct.

Solution (nitric acid)	Stable oxidation states in a solely nitric acid medium	Stable oxidation states in a nitric acid medium, in the presence of a stabilizing (e.g. antinitrous) agent	Other oxidation states in a nitric acid medium, requiring more complex stabilization
U	VI	IV	V
Np	V + VI	IV	–
Pu	IV + VI	III	V
Am	III	–	IV, V, VI
Cm	III	–	IV

Fig. 147. Main oxidation states exhibited by actinides in a nitric acid solution.

The differences in reactivity exhibited by each actinide, here again, result – in a changing molecular environment, in contact with a given atmosphere (which may be oxidizing, inert, or reducing), and moreover at high temperature – in phase demixing, complex adjustments in the mixed oxide's oxygen-to-metal (O/M) ratio, overoxidation... Thus, plutonium oxide ( $\text{PuO}_2$ ) is obtained, whether the atmosphere be oxidizing (air), or inert. By contrast, the coconversion into oxide of uranium, and plutonium entails the absence of air, or oxygen during calcination, or even a reducing atmosphere, if the desired ratio,  $\text{O/M} = 2$ , is to be achieved. At the same time, redox reactions between actinides cannot be ruled out, during such solid-state transformations.

### Innovative, actinide-based mixed solids

Investigations carried out at CEA/DEN have chiefly focused on ways of achieving the wet-route synthesis of novel mixed precursors, in solid form, involving a controlled composition, and *ensured actinide distribution homogeneity, at the molecular, or submicron scales* [2].

Oxalic acid thus emerged – owing to its ability to insolubilize actinides, whether in oxidation state IV, III, or even VI, its highly diverse coordination chemistry, and known use at the industrial scale (for plutonium) – as the reference reactant, for the purposes of synthesizing new, sparingly soluble, mixed – this being most crucial – oxalate compounds. Hydroxylation routes, relatively better known as they are, entail controlling the successive hydrolysis reactions undergone by the actinides in the mixture, making these as simultaneous as feasible, to promote homogeneity, as regards the actinide mixture, in the precipitated, or gelled hydroxide, or oxyhydroxide. Owing to the advantages afforded by sol–gel routes, for the purposes of obtaining solids of controlled morphology, significant work was thus conducted along this direction.

Thus, as regards oxalic coconversion, altogether original mixed oxalate structures [3] were prepared through an innovative process [4], and subjected to detailed investigation in ATALANTE, from 1999 on, to control the composition, and homogeneity with regard to actinides, of the mixed solid, whether it be uranium-, plutonium-, and/or minor actinide-based. One such structure (see Fig. 148), uranium(IV)-based, allows, in particular, oxalate solid solutions to be obtained, through “substitution” of uranium, within the structure, with an actinide in oxidation state IV, such as neptunium, and, far more strikingly, with an actinide in oxidation state III, such as Pu(III), Am(III), and/or Cm(III) (as regards the latter element, this is on the basis of syntheses involving lanthanides of equivalent ionic radius). Charge compensation, within the structure, is achieved by way of a redistribution of single-charged cations, also present around the mixed actinide site.

At the same time, this mixed oxalate phase proves particularly insoluble, in optimized conditions, while the characteristics

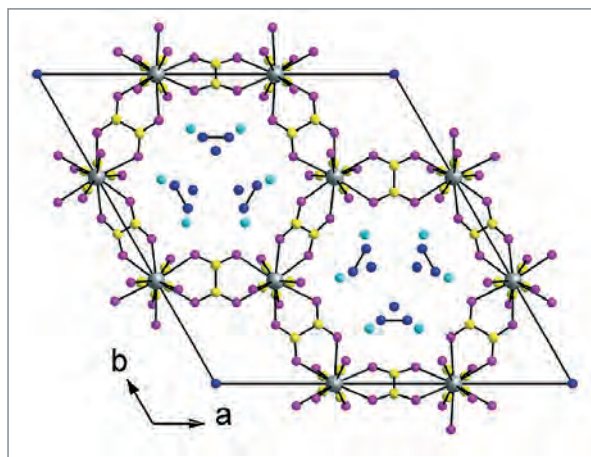

Fig. 148. Representation of the hexagonal mixed oxalate structure, as mapped across the (001) plane. Shown in gray: the mixed  $\text{An}'(\text{IV})\text{--An}''(\text{III})$  site; in yellow: carbon; in purple: oxygen [3].

exhibited by the mixed  $\text{An}'(\text{IV})\text{--An}''(\text{III})$  crystallographic site then result in the quantitative incorporation of actinides in oxidation states IV and III, initially present in the solution, within a single-phase oxalate coprecipitate [*note*: This occurs up to a U(IV) “substitution” rate of about 50%].

The chief advantage afforded by such structures is the fact that this perfect actinide mix, at the molecular scale, may be maintained, in controlled conditions, through the subsequent transformations, at high temperature, of the solid phase, down to the mixed oxide, this being a true  $(\text{An}', \text{An}'')\text{O}_2$  solid solution (with  $\text{An}' = \text{U}$  and/or Np,  $\text{An}'' = \text{Pu}$ , Am, and/or Cm), i.e. a single phase incorporating all of the actinides thus coconverted [5].

As regards sol–gel cogelation routes by hydroxylation, control of the solid's composition, and of the homogeneity of the actinide mixture within it, depends on the control achieved, as regards system reactivity. Actinide distribution homogeneity, in the best cases, is achieved at submicron scale, heat treatment then making it possible, as a rule, to obtain solid solutions, i.e. solids for which homogeneity of composition is ensured, at the molecular scale. Concrete instances will be illustrated in the paragraphs that follow, concerned with the development of these processes.

### The impact of minor actinides on the process

Involving minor actinides, as regards actinide recycling, is far from straightforward.

Neptunium, and the main isotopes of americium, and, more particularly still, of curium are characterized not only by high alpha radioactivity, but equally by gamma emissions, and, as regards curium, neutron emissions, entailing that handling of such elements, on any significant scale, be carried out in shielded cells.



At the same time, in a hydrometallurgical process involving curium, criticality-related constraints are greater with respect to the dominant Cm isotopes, i.e. Cm 244 and Cm 245, compared to what is required for the most abundant plutonium isotope (Pu 239). Thus, for Cm 245, the allowed subcritical mass, in water, stands at a few tens of grams or so. This unfavorable aspect results in mass, and concentration restrictions, and/or restrictions as regards use of pure curium streams, or the geometry of equipment used for the purposes of curium conversion, depending on the method implemented to take this risk on board, within the process.

Concomitant with such radioactivity, the significant heat release that may be caused by a given concentration of americium, and especially curium, in a solution, or a solid body, may significantly impair process operation, owing to uncontrolled degradations in the reactants involved, or in the forming additives used to fabricate the solid.

This constraint may be worked around, through optimized time management, or online mixing of the two elements involved, upstream of the coconversion operation.

As regards processes of the cogelation type, classically employing as they do higher actinide concentrations, or temperature-sensitive reactants, operations involving americium, and curium unquestionably, and unavoidably, entail that these elements be diluted with other actinide elements, such as uranium, and/or plutonium, in the context of group actinide conversion; or with the constituents of an inert matrix, e.g. zirconium, and yttrium, in order to obtain, subsequently, stabilized zirconia, incorporating these minor actinides [6].

## Development of coconversion processes for the fuel cycles of the future

### Initial results for oxalic coconversion

The feasibility of extrapolating this process to the industrial scale is based on Areva's experience with the PUREX process, of which the COEX™ process is an adaptation, to meet current spent fuel treatment requirements in some countries, including the United States, in terms e.g. of proliferation resistance.

Extending oxalic coconversion of uranium, and plutonium, to cater for any actinide mixture was contemplated from the inception of the process, provided the mixed actinides in solution can be reduced to oxidation states IV, and/or III, owing to the structural considerations mentioned earlier. This process thus applies equally, and perfectly well to minor actinides: neptunium, which may be stabilized in oxidation state IV; and americium, and curium, both of which are stable in oxidation state III.

The process allowing a mixed (Pu,Am)O<sub>2</sub> compound to be obtained by oxalic coconversion of Am, and Pu was also selected, under the aegis of the European FUTURE (Fuels for Transmutation of TransUranium Elements) program. This program involved, as regards the fabrication part, acquisition of the physical properties of these compounds. This synthesis method was subjected to tests in continuous mode, in a shielded line (see Fig. 149), resulting in the production of batches of several tens of grams oxide, involving a variety of compositions, of the form: Am<sub>x</sub>Pu<sub>1-x</sub>O<sub>2</sub> (x = 0.2, 0.5, 0.8).

As regards process performance, the coprecipitation efficiencies achieved in continuous operation were higher than 99%. X-ray scattering diagrams, obtained for each of the oxides synthesized, allowed confirmation of the single-phase character of these mixed compounds. The powders obtained, subsequent to heat treatment, involve specific surface areas of about 5 m<sup>2</sup>/g, i.e. favorable values, for the purposes of forming operations. Average particle grain size stands at around 10 μm, about the same size as that classically found with PuO<sub>2</sub> fabrication by oxalic conversion.

This synthesis route was used, subsequently, for the fabrication of two fuel compounds, to be subjected to the FUTURIX–FTA irradiation test [7].

On the strength of these achievements, an initial test involving the coconversion of uranium, plutonium, and minor actinides (U/Pu/Np/Am = 78/20/1/1) was initiated in 2005 (see Fig. 150), this validating the application of this process for the purposes of multirecycling all actinides, i.e. for minor actinide recycling in the homogeneous mode.

High-level experiments involving curium, scheduled in ATALANTE, in envelope conditions (10 at% Cm, relative to the total of all actinides) should corroborate the feasibility of applying this



Fig. 149. Coconversion of Pu(IV)–Am(III) into oxide form in the ATALANTE facility.



Fig. 150. Synthesis, at the scale of 1 gram or so, of a mixed U–Pu–Np–Am (78/20/1/1) oxalate in ATALANTE.

process to actinide solutions, and solids exhibiting strong radioactivity, and thus subjected to notable levels of radiolysis, and decay heat, provided some obvious technological adjustments are made, as regards deployment at the pilot, or industrial scale.

### The potentials of sol–gel conversion processes

With regard to specific applications, the advantages afforded by actinide coconversion in the form of cohesive, spherical particles, rather than relatively fine powders, currently warrants a reassessment of sol–gel-type processes, with a view to improving them.

As regards dedicated applications, concerned with minor actinides, or particle fuels for high-temperature reactors (HTRs), obtaining actinide solids in the form of “microspheres” – i.e. spheres involving diameters ranging from a few tens of microns to several millimeters, depending on applications – is useful, or inescapable, depending on application specifics. Such “tailoring” of the solid’s shape may, of course, be achieved by way of dry-route aggregation, however this is more advantageously effected (in particular, when stringent sphericity criteria are required) through gelation of a solution dispersed in the form of – ideally spherical – droplets. Transition from sol to gel is induced by hydrolysis: (1) of a colloidal sol, or of a stable microdispersion of oxyhydroxide nanoparticles (“true” sol–gel variant); or (2) of a concentrated metal ion solution, holding either a gelating additive (“internal” gelation variant), or surfactants and/or polymers, to increase the solution’s viscosity when it is dispersed, prior to bulk hydrolysis in a concentrated basic bath (“external” gelation, or gel-supported precipitation [GSP] variant).

Spurred on by *particle fuel* concepts, with regard to which the advantage of obtaining spherical particles is obvious, an experimental platform, at the semi-pilot scale, GAIA, was commissioned by CEA’s Fuel Research Department, at CEA’s Cadarache Center, to carry out external gelation, dedicated to majority uranium-based HTR fuels. As regards this type of reactor, fabrication of uranium- and plutonium-based fuels is also planned, this leading, in the past and indeed presently, to extensions of external gelation processes, to U(VI) and Pu(IV) cogelation.

As regards applications relating to minor actinide **recycling**\*, R&D has been experiencing an upturn, over the past few years, at the European level in particular, whether it be at the

Institute for Transuranium Elements (ITU, Germany), at the Jülich Research Center (JFZ, Germany), or at CEA.

At CEA, at the laboratory scale, in the ATALANTE facility, investigations have been conducted since 2003, for the purposes of acquiring basic data still lacking, as regards minor actinides; adjusting gelation conditions to the chemistry of these radioelements (see Fig. 151); and achieving an overall simplification of the process, to evaluate its potential, with respect to applications at the fuel fabrication scale [8].

On the basis of the internal gelation process, upstream studies, addressing redox properties, and hydrolysis, in actinide mixtures, have been undertaken. In concrete terms, two types of investigation have thus been initiated. A first aspect involved controlling the reactivity of a known, U(VI) + Pu(IV)-based chemical system, and comparing it with that of a U(IV) + Pu(III)-based system, not previously studied, intended for use for the purposes of diluting, in reducing conditions, minor actinides, in oxidation states IV, as regards neptunium, III as regards americium, and curium. This original configuration affords the potential benefit of easier hydrolysis control, in a IV+III mixture, as compared to a VI+IV+III+V mixture, by extrapolating earlier work on U(VI) + Pu(IV) mixtures. The second, more conventional, aspect involves taking advantage of the known hydrolysis properties of transition elements, such as zirconium, in certain favorable cases, with regard to combining them with minor actinides; and of the R&D devoted to “inert matrices,” for transmutation targets. In this context, cubic yttrium-stabilized zirconia is one of the more extensively investigated matrices. The variants involving internal gelation, or colloidal sol–gel processes were the chief candidates explored, in this respect. The feasibility of the cogelation of zirconium, yttrium, and lanthanides – simulating americium, or curium –

was demonstrated, in collaboration with the Jülich Research Center, under the aegis of the European EUROPART program (coming under the 6th Framework Program [FP6]), and process development should proceed, with the continuation of the collaborations thus set up.

Looking further, as regards gelation processes, highly promising results were achieved, at CEA, with the colloidal sol–gel variant [9]. By controlling zirconium hydrolysis, through the use of specific complexing molecules, it was possible to modulate the reactivity of this element, in oxidation state IV, to adjust it to that of trivalent Y<sup>3+</sup> and Am<sup>3+</sup> cations, and thus obtain a colloidal sol, as precursor for mixed gels that could be tailored in the form of a variety of monolithic shapes, including microspheres (see Fig. 152).

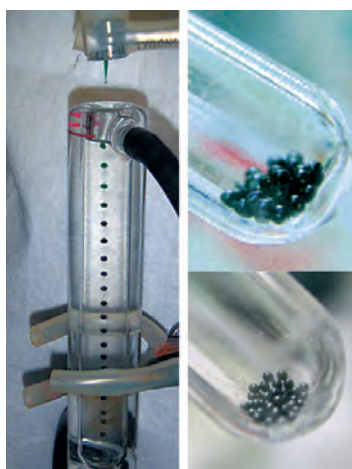

Fig. 151. Illustrated: U–Pu internal cogelation tests carried out at CEA, in the ATALANTE facility. Left: gelation column; right (top): U + Pu gel beads; right (bottom): (U,Pu)O<sub>2</sub> spheres, subsequent to calcination.

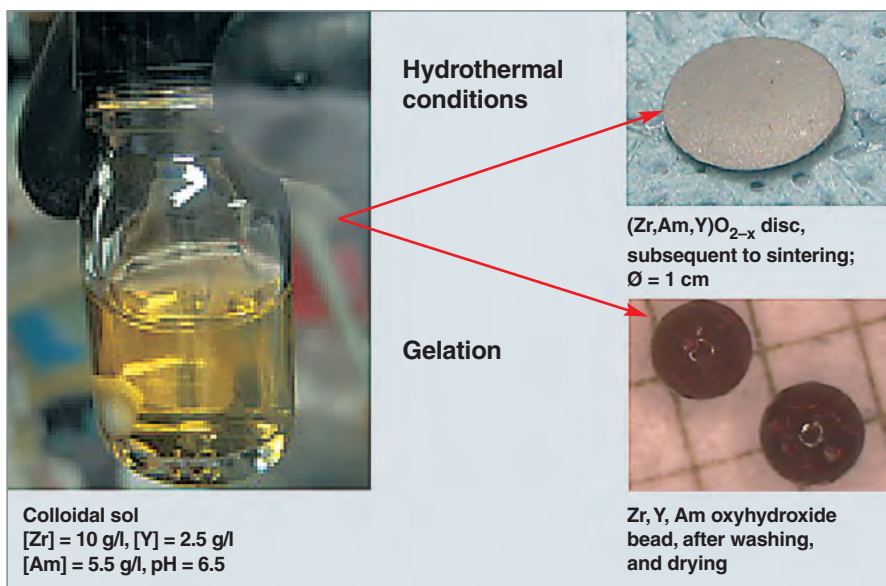

Fig. 152. Illustration of the conversion tests by the sol-gel route, carried out at CEA.

This outcome perfectly illustrates the benefit that accrues from exploring the advances achieved with soft chemistry, to apply this to actinide transformation. Soft chemistry, indeed, allows better-controlled materials to be obtained, through control of the chemical system's reactivity, from solution through to solid, while limiting, at the same time, use of reactants to the quantities strictly required, and restricting heat treatments to the sole, final step of ceramization.

Subsequent to research work on uranium, carried out at the US Oak Ridge National Laboratory, and at CEA, CEA/DEN has been extending, over the past few years, to cater for minor actinides, a process involving denitration, coupled with fixing

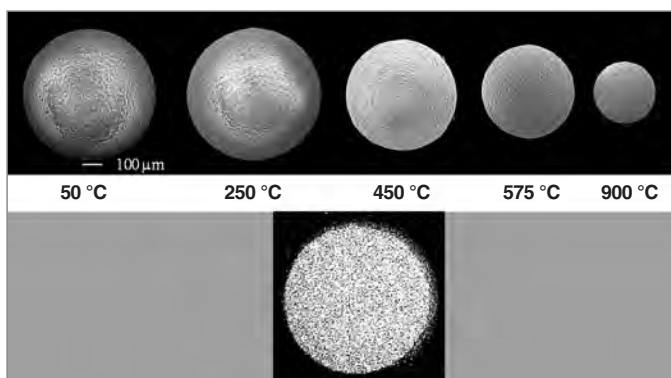

Fig. 153. Top: an illustration of the "shaping" effect of resin, in the course of heat treatment, from the resin bead fixing the actinide nitrate, through to the actinide oxide (in this test, the actinide was simulated by neodymium).

Bottom: this X-ray microprobe analysis shows the neodymium distribution, within the oxide sphere, to be homogeneous.

elements onto an organic substrate, in particular onto ion-exchange resin (IER) beads. The inert matrix acts as a "template," during high-temperature denitration (see Fig. 153).

The benefit further afforded by this route is that it allows, in certain conditions, the carbon from that matrix to be retained, to yield carbide, or oxycarbide phases, as achieved in the past for the uranium phase, in dedicated high-temperature reactor (HTR) fuels. Taking the form of porous, or dense spheres, depending on the heat treatment carried out, the solids thus fabricated may be pelletized, or used as is, to fill fuel claddings (VIPAC-, or SPHEREPAC-type processes).

### Towards development of actinide coconversion processes at the industrial scale

Selecting an actinide conversion, or coconversion process depends on a number of criteria, relating to the specific characteristics of the actinide recycling mode opted for, and the characteristics desired, for the actinide compounds fabricated, with regard to their subsequent transformation, these in turn depending on the fuel, and reactor being considered.

The feasibility of using one process, or another, on an industrial scale has yet to be determined, in particular as regards applying such processes to minor actinide conversion, i.e. operating them in a high-level environment.

Presently, the process affording the broadest potential is, unquestionably, oxalic conversion, this being in fairly universal use at the industrial scale, for plutonium, and at the laboratory scale, as regards minor actinides. At the same time, its flexibility, as demonstrated, more recently, with the development of coconversion processes, means it is particularly well suited for joint actinide management, whether it be of uranium and plutonium, as in the COEX™ process, or of minor actinides diluted with another actinide, such as uranium, or of all actinides, subsequent to their extraction from spent fuel. Such broad capabilities will probably prove valuable, whether it be for the purposes of recycling plutonium, intimately mixed with uranium, or minor actinide recycling in the heterogeneous mode (targets, or blankets bearing concentrated minor actinide loads), or for the recycling of all actinides in the homogenous mode.

The other chief advantages afforded by this process may be summed up as follows:

- control of the solid's composition, with respect to actinides, through coconversion efficiencies higher than 99%;
- outstanding actinide distribution homogeneity, from the solution through to the coconversion endproduct, this meeting, in particular, specified requirements with regard to enhanced fissile material proliferation resistance, and nondissemination of minor actinide-based particulates;
- the feasibility of adjustments to cater for a variety of coprecipitation technologies, including those proven on an industrial basis;
- yielding effluents, the treatment and recycling of which have been mastered at the industrial scale...

In the current state of R&D, the maturity of sol-gel, or cogelation processes is not sufficient to allow a conclusion to be drawn, as to their possible industrialization. The major benefits they do afford, in terms of forming the solid product, with regard to minor actinide applications, do not counterbalance, as of now, the complexity of the various steps involved in the process, singularly compounded by radiolytic, and thermal effects (preparation stability, degradation of additives, structural evolution), not to mention issues as regards management of the effluents yielded.

The avenues for improvement, as regards the fuel treatment and refabrication processes being designed, and developed for the coming generations of nuclear systems, involving in particular turning to novel actinide coconversion processes, were specified, in a preliminary phase, under the aegis of the Generation IV International Forum, and, more recently, of the US Global Nuclear Energy Partnership (GNEP) initiative. Their deployment, in concrete form, calls for intermediate demonstrations, at the laboratory, and pilot scale.

With that aim in mind, the oxalic coconversion process, for actinides, is currently part and parcel of the preliminary discussions taking place, as to future pilot projects. In the event of the decision being taken, to go ahead with construction of a MOX fuel fabrication workshop, for the future French prototype fast reactor (target commissioning date for which is set at 2020), the basic material for such a fuel could easily involve a (U,Pu)O<sub>2</sub> oxide solid solution, produced by oxalic coconversion, on the basis of the R&D that has been conducted at CEA, in the ATALANTE facility, for close to 10 years.

## ► References

- [1] C. MESMIN, A. HANSENS, P. BLANC, C. MADIC, M.F. DEBREUILLE, "Procédé de coprécipitation d'actinides et procédé de préparation d'oxydes mixtes d'actinides", French Patent No. FR/00-12727, 2000 ("Method for co-precipitating actinides and method for preparing mixed actinide oxides", International Patent No. WO/2002/028778, 2002).
- [2] S. GRANDJEAN, B. CHAPELET-ARAB, S. LEMONNIER, A-C ROBISSON, N. VIGIER, "Innovative synthesis methods of mixed actinides compounds with control of the composition homogeneity at a molecular or nanometric scale", *MRS Proceedings, Vol. 893, Symposium JJ, Actinides 2005 – Basic Science, Applications and Technology*, 0893-JJ08-03, Materials Research Society, 2006.
- [3] B. ARAB-CHAPELET, S. GRANDJEAN, G. NOWOGROCKI, F. ABRAHAM, "Synthesis and characterization of mixed An(IV)An(III) oxalates (An(IV) = Th, Np, U or Pu and An(III) = Pu or Am)", *Journal of Nuclear Materials* 373, 2008, pp. 259–268.
- [4] S. GRANDJEAN, A. BÉRÈS, J. ROUSSELLE, C. MAILLARD, "Method for coprecipitation of actinides in different oxidation states and method for preparation of mixed actinide compounds", International Patent No. WO/2005/119699, 2005.
- [5] P. MARTIN, S. GRANDJEAN, C. VALOT, G. CARLOT, M. RIPERT, P. BLANC, C. HENNIG, "XAS study of (U<sub>1-y</sub>Pu<sub>y</sub>)O<sub>2</sub> solid solutions", *Journal of Alloys and Compounds* 444–445, 2007, pp. 410–414.
- [6] S. PILLON S, J. SOMERS, S. GRANDJEAN, J. LACQUEMENT, "Aspects of fabrication of curium-based fuels and targets", *Journal of Nuclear Materials* 320, No. 1–2, 2003, pp. 36–43.
- [7] L. DONNET, F. JORION, C. LEORIER, N. DRIN, "The FUTURIX–FTA Experiment in Phénix. Status of the oxide fuels and pins fabrication", *GLOBAL 2007: Advanced Nuclear Fuel Cycles and Systems*, Boise, Idaho (USA), 9–13 September 2007.
- [8] A.-C. ROBISSON, E. MACHON, J. DAUBY, C. DUMONT-SHINTU, S. GRANDJEAN, "Actinides co-conversion by internal gelation", *MRS Fall Meeting 2006*, Boston, Massachusetts (USA), 26–30 November 2006.
- [9] S. LEMONNIER, S. GRANDJEAN, A.-C. ROBISSON, J.-P. JOLIVET, "Sol-gel chemistry applied to the synthesis of Am-bearing cubic stabilized zirconia: reactivity and structure from solution to solid state", *9th Information Exchange Meeting on Actinide and Fission Product Partitioning and Transmutation*, Nîmes (France), 25–29 September 2006.
- [10] A. FERNANDEZ, D. HAAS, J.-P. HIERNAUT, R. KONINGS, C. NÄSTREN, H. OTTMAR, J. SOMERS, D. STAIU, "Overview of ITU work on inert matrix fuels", *9th Information Exchange Meeting on Actinide and Fission Product Partitioning and Transmutation*, Nîmes (France), 25–29 September 2006.

**Stéphane GRANDJEAN,**  
*Radiochemistry and Processes Department*

# Fuel refabrication

## Refabrication: challenges, and constraints

Refabrication stands as a key step in the fuel cycle of the future, as it allows the cycle to be closed, as the indispensable prerequisite for the in-reactor multirecycling of minor actinides (americium, curium, neptunium). As shown in the overview of recycling, set out below, refabrication, involving as it does the main operations of fissile compound fabrication and forming, and sealing of the fuel elements, is carried out downstream of the operation of actinide coconversion into a mixed oxide powder, suitable for pressing, and **sintering\***.

Treatment		
Access to the fissile compound	Actinide partitioning	Actinide coconversion
Refabrication		
Fabrication of the fissile compound	Forming Pressing Sintering	Sealing (assembly)

Two kinds of minor actinide-bearing fuels are being investigated: oxide fuel, currently seen as the reference startup fuel, for the fleet of sodium-cooled fast reactors (**SFRs\***); and, in the longer term, carbide fuel, a more innovative fuel, also being developed for the gas-cooled fast reactor (**GFR\***) line.

As regards neutronics, a fast-neutron reactor, or fast reactor (FR), comprises a driver core, holding fissile fuel elements, and able to accommodate, at its periphery, dedicated fuels, or blankets. Initial minor actinide management scenarios, in a fleet of Generation-IV reactors, yield, depending on the recycling mode being contemplated (homogeneous/heterogeneous), the following approximate quantities, as regards minor actinide contents, envelope contents being the maximum val-

ues liable to occur during the Gen III → Gen IV transition, for the reactor fleet (see Table 17):

While Np/Am mass ratios, in fuels, as in blankets, stand close to unity, the Am/Cm ratio is one order of magnitude smaller (~1/10). Thus, in the homogeneous recycling case, curium contents could lie in the 0.1–0.2% range, as against 1–2% americium, while these values would be about 10 times greater, for blankets.

## Specific characteristics of fuels incorporating minor actinides

The presence of minor actinides, of americium, and curium, in particular, owing to the intense  $\alpha$  and  $n$  emissions involved [spontaneous decays, and ( $\alpha, n$ ) reactions in oxygen], results in a considerable change, in terms of source term, for fabrication workshops, as compared to what is involved by **MOX\*** fuel fabrication, at Areva's **MELOX\*** plant. By way of example, Table 18 brings together, for ease of comparison, the typical average values involved for such outcomes of these emissions as neutron fluence rates, and thermal power outputs, along with alpha activities, for the fuels being considered.

Thus, aside from the need for protection against the 59-keV  $\gamma$  radiation, yielded by americium-241 decay, the neutron emission from minor actinide-bearing blankets, higher by about 4 decades as it is, compared to FR MOX fuel, for fast-reactor driver cores, should entail that the fabrication of minor actinide-bearing fuels is carried out behind a heavy thickness of biological protection (shielded cells).

Other effects from this neutron emission, coupled to the intense alpha radiation (yielding helium), include the possible damage caused to the structure of actinide compounds (amorphization of crystal structures), and impact on fuel pellet

Table 17.

Composition of oxide fuels, and blankets being considered for SFRs.				
	Fuel (homogeneous recycle)		Blanket (heterogeneous recycle)	
	Reference (%)	Envelope (%)	Reference (%)	Envelope (%)
U	80	55	90	60–75
Pu	18	40	0	0–15
Minor actinides (Am + Np + Cm)	2	5	10	40–10

Table 18.

Neutron characteristics, alpha activities, and thermal power for fuels incorporating minor actinides.						
	AmO <sub>2</sub>	CmO <sub>2</sub>	MELOX MOX at beginning of life	FR MOX at beginning of life	Homogeneous fuel	Minor actinide-bearing blankets (MABBs)
Neutron fluence (n/s·g)	4.3·10 <sup>6</sup>	8.9·10 <sup>8</sup>	360	810	9–18·10 <sup>5</sup>	9–18·10 <sup>6</sup>
Thermal power (W/g)	0.11	2.8	2·10 <sup>-3</sup>	4·10 <sup>-3</sup>	7–10·10 <sup>-3</sup>	0.04–0.08
Alpha activity* (Bq/g)	7·10 <sup>10</sup>	3·10 <sup>12</sup>	3.3·10 <sup>9</sup>	7.3·10 <sup>9</sup>	1.1–1.5·10 <sup>10</sup>	4–7·10 <sup>10</sup>

Table 19.

Typical values, for both recycling modes, of temperatures arising in minor actinide-bearing oxide compound powders, and pellets.		
Fuel type	Powder canister (Ø 100 mm, h: 100 mm)	Pellet (Ø 10 mm)
Homogeneous fuel	100–200 °C	50–60 °C
MABB	400–800 °C	110–130 °C

mechanical behavior, from fabrication to loading the fuel element into the reactor. The magnitude of such damage must be evaluated, to ascertain it remains sufficiently low to ensure safe in-reactor operation.

Finally, the final phenomenon resulting from incorporation of minor actinides is the thermal power yielded by the oxide ceramic. By way of example, Table 19 sets out typical values for the temperatures liable to arise at the center of canisters used for the storage of minor actinide-rich powders, as yielded by coconversion, and at the centerline of sintered pellets, ready for insertion into cladding.

The magnitude of such heat release, which will need to be more precisely evaluated, depending on the evolution of elemental, and isotopic composition in fuel, and blanket materials, should probably lead to the implementation of the following measures, to ensure process safety, and the integrity of the oxides produced, including, in particular:

- suitable systems to ensure cooling of containment enclosures, tooling, and the various storage points;
- inerting workshop cells, to preclude possible issues due to actinide compound oxidation, at the various stages of fabrication.

To sum up, considerable R&D work is still required, in particular with respect to minor actinide-bearing blankets, if a fuel is to be designed, having the ability to withstand both phenomena, of irradiation damage, and thermics.

## Special characteristics of carbide fuel

The pyrophoricity of a chemical compound is characterized by its affinity for oxygen. Depending on the degree to which the reaction is exothermic, oxidation may result in effects going as far as spontaneous ignition of the solid.

Such pyrophoricity is more or less marked, depending on compound physical state (this coming mainly in powder form; or as a bulk compound to a lesser extent), and on temperature, and oxygen content, and/or moisture. This is the case, as regards actinide carbide compounds. As shown in Figure 154, the ignition temperature, in air, of uranium carbide stands close to 200 °C. In the case where oxygen content is less than 3%, oxidation is found to occur, however no ignition ensues. Handling, and thus fabrication of carbide fuels should entail primary inerting measures, as regards fuel forming facilities. On the other hand, in bulk form (e.g. in pellet form), and at

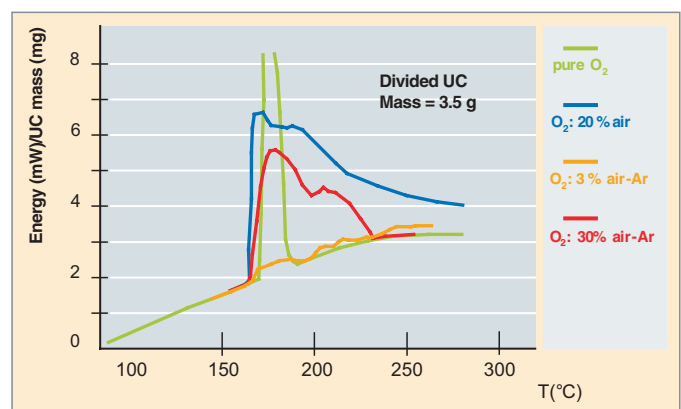

Fig. 154. Influence of oxygen content on the energy involved in the oxidation reaction, for uranium carbide in the divided state.

ambient temperature, the pyrophoric character exhibited by such actinide compounds is far less marked, while mechanical impacts must nonetheless be avoided (risk of sparking).

## Advances in R&D studies

### The oxide pathway

The ensemble of investigations currently being conducted at CEA has the purpose of demonstrating the ability to master, at the laboratory scale, the minor actinide-bearing fuel fabrication process by powder metallurgy. This fabrication process is based on the MELOX process, the principle for which is set out in Figure 155.

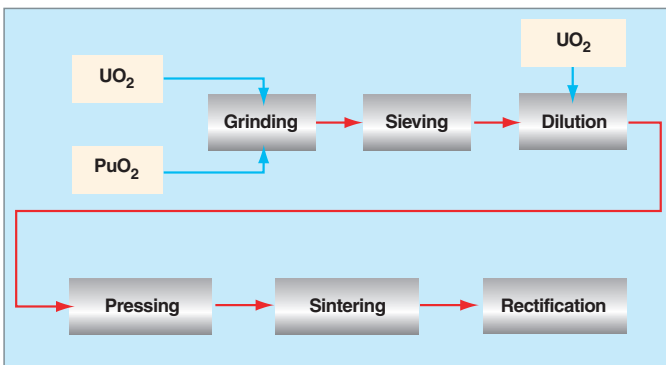

Fig. 155. Principle of the MELOX fabrication process for MOX fuel.

The grinding step has the purpose of blending, and homogenizing  $\text{UO}_2$  and  $\text{PuO}_2$  powders, and ensuring the uniformization of powder morphologies. Grading of grain sizes, for the mixture, is then achieved by sieving, followed by dilution with  $\text{UO}_2$  powder, to adjust Pu content to the target composition value. The powder is then pressed into so-called “green” pellet form, prefiguring the final form. Pellets subsequently undergo sintering in a furnace, at high temperature. This step, ensuring as it does improved mechanical strength for the pellet, and better approximation of the target geometry, promotes the transition from a system of distinct, individual particles to a compact, monolithic state. The final step (rectification) allows pellet dimensions to be adjusted, to within set allowances.

R&D investigations are aimed at simplifying, and optimizing this process, by doing away with the preliminary mechanical grinding treatment. This is becoming feasible, owing to the quality, and morphology of mixed actinide oxide powders fabricated by coconversion, these being immediately suitable for pressing, and sintering. The desired process principle is set out in Figure 156. Two fabrication options are currently being investigated, as regards fabrication of MOX fuels, whether incorporating minor actinides, or otherwise:

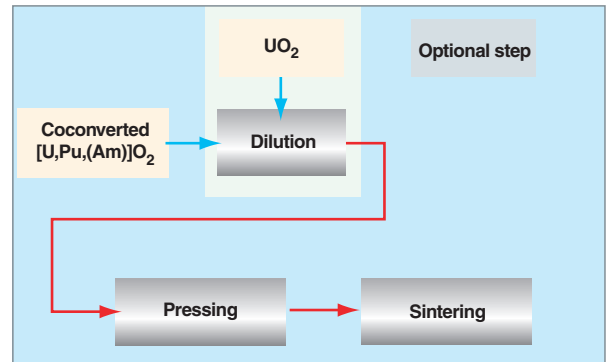

Fig. 156. Simplified fabrication process.

- fabrication subsequent to dilution of a high-actinide-content powder in  $\text{UO}_2$  powder;
- direct fabrication, from powder coconverted to the desired final actinide content.

The fuel densification step is likewise being reconsidered, to yield, at the end of the sintering cycle, pellets complying with specifications: dimensions, aspect, density, porosity, stoichiometry, microstructural homogeneity, impurity content... the main goal being to do away with the rectification step, which by its very nature stands as a strong source of contamination.

To sum up, the challenges set by the fabrication of minor actinide-bearing fuels chiefly concern achieving control of:

- the morphological characteristics exhibited by coconverted powders;
- the microstructures of the fabricated products;
- pellet dimensional characteristics, to allow doing away with a rectification step.

Minor actinide-bearing fuel pellets have already been fabricated in ATALANTE, for the purposes of the international irradiation experiments carried out in the Phénix reactor. Mention may be made, e.g., of the FUTURIX program (see Fig. 157),

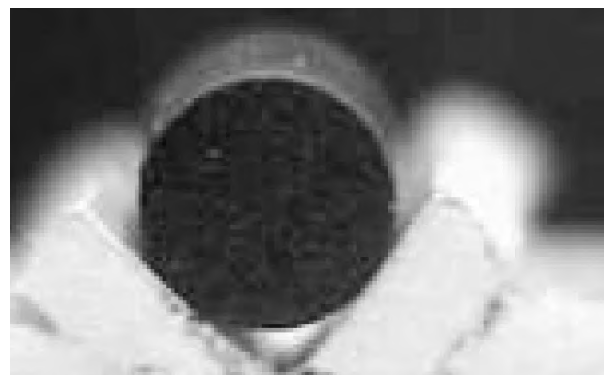

Fig. 157. View of a FUTURIX pellet.

involving the fabrication of a number of cerer pellets of the  $(\text{Pu},\text{Am})\text{O}_2$  type (featuring americium contents ranging from 30% to 80%), diluted in a MgO matrix; and pellets for the EUROTRANS program, fabricated from a  $(\text{Pu},\text{Am})\text{O}_2$  powder directly coconverted to its final composition.

Finally, for the purposes of the COPIX program, investigating the behavior, in fast reactor (Phénix) conditions, of a coconverted  $(\text{U},\text{Pu})\text{O}_2$  mixed oxide fuel, two distinct microstructures were fabricated. The first one involved powder directly coconverted to the final Pu content value, then pelletized, and sintered. The second one used powder converted to a Pu content of 45%, and diluted in  $\text{UO}_2$ , prior to pelletization, and sintering. The purpose of this R&D investigation was to achieve simplification of the standard powder metallurgical process.

As shown in Figure 158, the comparison of micrographs of  $(\text{U},\text{Pu})\text{O}_2$  pellets fabricated from coconverted  $(\text{U},\text{Pu})\text{O}_2$  powder, and by way of blended powders, using the conventional MIMAS and COCA processes, highlights the quality of the oxide structure thus formed, and the homogeneity of uranium, and plutonium distribution at grain scale.

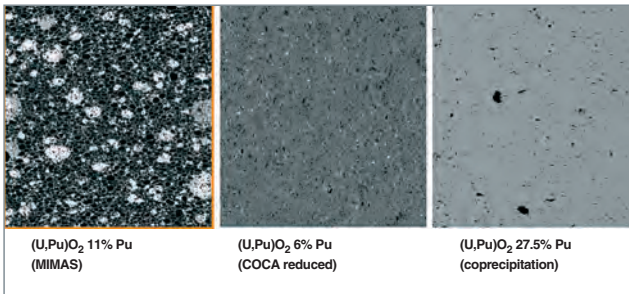

Fig. 158. Comparison of micrographs (made at CEA's LEFCA laboratory) of pellets fabricated by the conventional COCA and MIMAS processes, and from coconverted powders.

Finally, more recently, in the context of the program on full actinide recycling, as shown in Figure 159,  $(\text{U}_{0.8}\text{Pu}_{0.187}\text{Np}_{0.006}\text{Am}_{0.006}\text{Cm}_{0.001})\text{O}_2$  pellets were fabricated to the target composition, from a blend of  $\text{UO}_2$ ,  $\text{PuO}_2$ ,  $\text{NpO}_2$ ,  $\text{AmO}_2$ ,  $\text{CmO}_2$  powders, in order to ascertain the issues raised by the presence of these multiple constituents, at such contents.

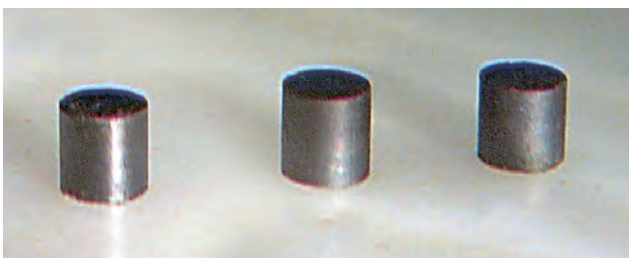

Fig. 159.  $(\text{U},\text{Pu})\text{O}_2$  mixed oxide pellets incorporating some americium, some neptunium, and some curium.

### The carbide pathway

As regards carbide fuels, significant advances were achieved, in particular with regard to the intermediate step of oxide carbothermy. The X-ray scattering spectrum, as shown in Figure 160, yielded by the crystalline phase formed subsequent to reduction by elemental carbon, evidences the complete transformation of  $(\text{U},\text{Pu})\text{O}_2$  into a carbide compound.

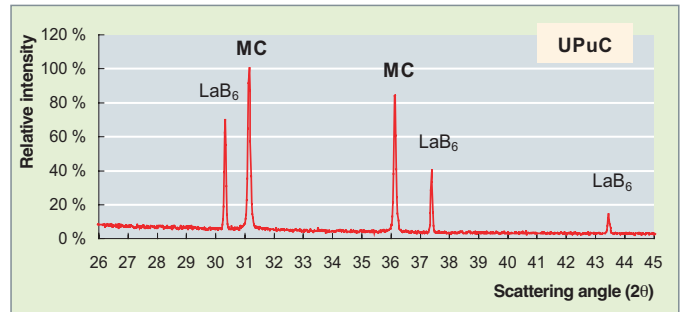

Fig. 160. X-ray scattering spectrum for a uranium and plutonium carbide compound (MC), fabricated by carbothermy from an oxide form.



Fig. 161. View of  $(\text{U},\text{Pu})\text{C}$  samples used in the FUTURIX-Concept experimental irradiation.

This process was used recently for the fabrication of  $(\text{U},\text{Pu})\text{C}$  samples, for the FUTURIX-Concept irradiation experiment, carried out in Phénix (see Fig. 161), to validate fuel thermo-mechanical behavior, and released fission gas volume, at beginning of life, in fast reactor conditions.

### Other innovative fabrication pathways

One issue that is anticipated, as regards actinide recycling, is the potential risk of powder dissemination, acting as a source of contamination, and irradiation in fabrication facilities, possibly resulting, ultimately, in unacceptable maintenance constraints, for the equipment.

To preclude such a risk, wet processes, based on extrusion, and injection of actinide mixes in paste form, are being investigated. It should be noted that such processes further afford the advantage of curbing, to a considerable extent, the pyrophoricity risk, for carbide compounds.



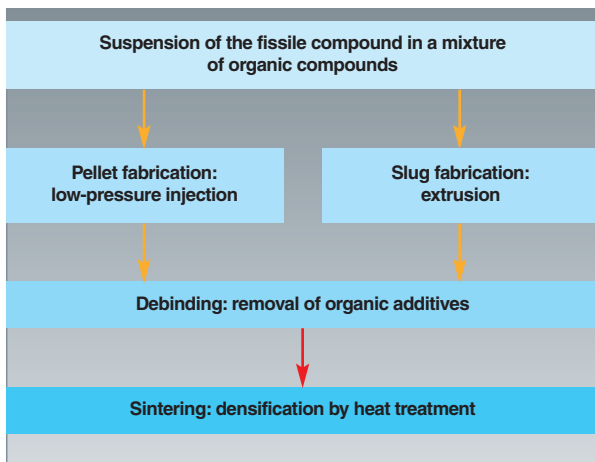

Fig. 162. The steps involved in the paste route process.

The principle of the fabrication cycle involving these processes is set out in Figure 162.

Extrusion involves forcing the plastic mixture through a die, to produce, on a continuous basis, rods of constant section. A view of a small-diameter tungsten carbide rod, fabricated by this technique, is shown in Figure 163. The rods are subsequently cut, on exiting the extruder, into short segments, or slugs (of about the same size as a pellet). By contrast, injection involves forcing the plastic mixture directly into a mold cavity, already providing the preform of the desired final object.

Paste plasticity is ensured by organic additives in the mixture, promoting shear thinning behavior in the paste, as required to facilitate flow, and object forming.

Other innovative pathways, possibly affording prospects of interest, such as sol-gel, and VIPAC processes are likewise being evaluated. Indeed, some of these pathways could allow, by way of synthesizing granulates, rather than powders, considerable reductions to be achieved, as regards the issues of aerosol dissemination, inherent in the powder metallurgical process.

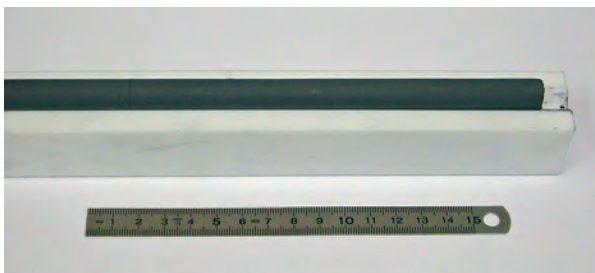

Fig. 163. View of a tungsten carbide rod, fabricated by extrusion.

## Prospects

In accordance with a highly tentative scenario, involving a reactor fleet of 60 GWe installed power, solely comprised of fourth-generation reactors, recycling actinides in the heterogeneous mode, the amounts of  $(U,Pu)O_2$  fuel required to replenish the driver cores would stand at some 600 t/year, plus a few tens of tonnes, per year, as regards the minor actinide-bearing blankets.

In the current state of knowledge, powder metallurgy, based on the principle of the MELOX process, using coconverted mixed actinide oxides, stands as the reference process, and has been so selected. Looking forward, the challenge that must be met is that of extrapolating the process, as validated at the scale of a few  $(U_{0.8}Pu_{0.187}Np_{0.006}Am_{0.006}Cm_{0.001})O_2$  pellets, to the industrial production, to the tune of several tens of tonnes per year, of minor actinide-bearing fuels. Such industrialization entails, as a prerequisite, that this fabrication development work be carried forward, using remotely operated technologies, to involve significant quantities of actinides. Such is the purpose of the minor actinide micropilot program, involving a twofold objective: qualification of the simplified fabrication process, leading to the production, and controlled fabrication of pellets meeting the desired specifications; and the fabrication of experimental fuels, for the purposes of fast-reactor transmutation demonstrations.

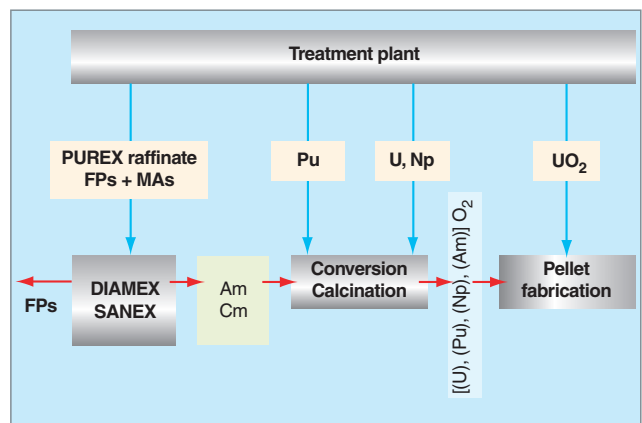

Fig. 164. Possible options for the fabrication of minor actinide compounds, from materials available at the La Hague (France) site.

The proposed configuration, for this micropilot, would allow, depending on requirements, a gradual coming on stream of the facility, involving the supply e.g. of  $(U,Pu)O_2$ , or  $(U,Pu,Np)O_2$  (driver core fuels), and subsequently of  $(U,Np,Am)O_2$  for the purposes of heterogeneous transmutation studies, the sole hard requirement being the production line (see Fig. 164). On the other hand, curium-bearing fuels, or experimental irradiations for homogeneous recycling purposes will require, on top of the fabrication line, deployment of a

hydrometallurgical minor actinide partitioning step, either from the PUREX raffinate, or directly from the dissolution solution. The design, and dimensioning for this workshop are still at the discussion stage.

**Vincent ROYET,**  
*Fuel Cycle Technology Department,*

**Éric ABONNEAU,**  
*Reactor Research Department,*

**Michel MASSON,**  
*Radiochemistry and Processes Department*

## Pyrometallurgical processes

From the outset of investigations on the treatment of spent nuclear fuel, separation techniques involving high-temperature molten salt media (see Table 20) were developed. The prime goal was to bring down treatment costs, whether it be for the recovery of plutonium for military purposes, or for uranium, and plutonium recovery for civil uses. Such cost reductions were anticipated, on the grounds of these processes' compactness, and the reduction in the number of conversion steps involved for actinide recovery.

Table 20.

High-temperature molten salts of interest for the purposes of pyrochemical processes.	
Salt	Working temperature
Hydroxide	150–250 °C
Nitrate – nitrite	300–500 °C
Chloride	400–800 °C
Fluoride	700–1,300 °C
Tungstate	700–900 °C
Molybdate	1 000–1,200 °C

Initial investigations allowed novel actinide conversion and partitioning techniques to be developed, such as calciothermy, fractionated precipitation in molten chlorides, molten salt/liq-

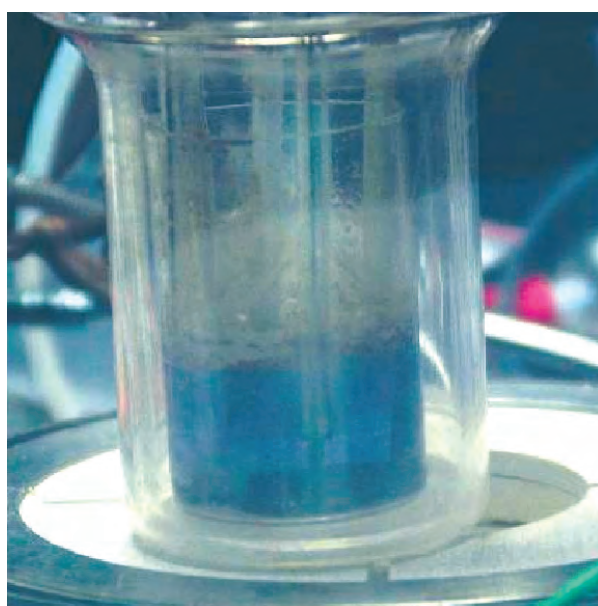

Fig. 165. A solution of trivalent plutonium in a molten chloride medium (LiCl–KCl eutectic) at 500 °C.

uid metal liquid–liquid extraction, or electrolytic separation in molten halides (chlorides, or fluorides) (see Fig. 165). Such unit operations, carried out at high temperature, and involving nonaqueous solvents, form the core of so-called **pyrometallurgical\***, or **pyrochemical\*** processes.

### Current applications, and limitations of pyrochemistry

The application of this type of process to the treatment of civil nuclear fuels was first considered in the context of development work for the fast-neutron reactor (fast reactor) line. Indeed, such reactors prove tolerant of far less thorough fissile material decontamination, with respect to fission products, than what is required for thermal-neutron reactors, and such a target may be achieved in a minimum number of steps, through molten-salt separation techniques.

Two processes went beyond the laboratory stage: one in the United States, the other in Russia; they are currently used for the treatment of spent fuels yielded by fast reactors. Based as they are on electrolytic separation (electrolysis, or electrorefining, depending on the process) in a molten chloride medium (~ 500 °C), these processes allow recovery either of high-purity uranium, from metal fuel (some 3.5 tonnes of fuel from the EBR–II reactor have thus been treated at Idaho Falls [USA], since 1996), or of (U,Pu)O<sub>2</sub> from vibrocompacted oxide fuel (several tens of kilogram fuel from the BOR–60 and BN–350 reactors being thus treated at Dimitrovgrad [Russia]) [1].

However, these two instances of demonstrations at the pilot scale do show up the limitations of this type of process: (i) the inability to recover each actinide separately; (ii) the low value of the **decontamination factors\*** involved, with respect to fission products, compared to those achieved with hydrometallurgical processes.

## Potentials for the nuclear energy technologies of the future

By setting out, as a direction for research, the partitioning and transmutation of long-lived radionuclides, Direction 1, in the so-called “Bataille” Act (from the name of the author of the report to the French National Assembly on this measure) of December 1991 on radioactive waste management research, brought about a resurgence in interest for pyrochemical processes, chiefly with respect to scenarios involving actinide recycling [2].

On the one hand, in order to restrict the yield of actinides from uranium-238, consideration was given to the transmutation of actinides held in an inert matrix substrate, whether it be in targets (heterogeneous recycle), or dedicated fuels (double stratum scenario). And, on the other hand, some scenarios contemplated actinide multirecycling, to achieve high transmutation rates.

With regard to these new concerns, pyrochemical processes exhibit advantageous inherent characteristics: (i) the ability to effect joint actinide management (so-called “group” partitioning); (ii) the ability to dissolve highly irradiated, and/or not extensively cooled objects, or inert matrices; (iii) the insensitivity to radiation of the solvents involved (high-temperature ionized media, liquid alloys). Finally, the advantage of switching to such processes becomes even more apparent with regard to options seen as longer-term prospects, such as transmutation in molten-salt reactors.

A pyrochemistry research program was thus set in train by the French Atomic Energy Commission’s (CEA) Nuclear Energy Division, in the late 1990s, to provide evidence as to the scientific feasibility of the recovery of all of the actinides present in spent fuel, in the context of a number of scenarios: heterogeneous, or homogeneous recycling, involving the group extraction of actinides, or group extraction, followed by uranium–transuranium element separation, or (U,Pu)–minor actinide separation. While it was mooted, and subsequently launched to respond to the requirements of the French Act of 1991, this program now makes it possible to provide some data, in terms of evaluation, for the longer-term strategies being considered with respect to the cycles involved by fourth-generation nuclear systems, for which full actinide recycling is being proposed.

## The pyrochemical processes being investigated

The actinide–fission product separation aspect was addressed in a context broadly open to international efforts, by way of collaborations with Russia, the United States, and Japan, and European contracts under the aegis of the European Union’s 5th Framework Program (FP5: PYROREP), and FP6

(EUROPART). Three separation techniques were initially selected, for investigation. One of these, fractionated separation from molten chlorides, does not allow quantitative An–FP separation, and was subsequently abandoned; the two other techniques, namely liquid–liquid extraction involving a molten salt and a liquid metal, and electrolytic separation, are currently targeted by numerous investigations, at the laboratory scale.

### Separation by liquid–liquid extraction

CEA is evaluating an innovative route [2,3], which may be adjusted, by means of an appropriate upstream step, to cater for fuels (or minor actinide targets) of the carbide, oxide, or nitride type.

This route involves a molten fluoride reaction medium, affording a twofold advantage, compared to molten chlorides: (i) fluoride waste is directly immobilizable in a vitroc ceramic matrix, of the type produced, on an industrial basis, by vitrification in the La Hague (France) plants; (ii) the separation factors involved, between actinides and fission products (lanthanides in particular), are higher.

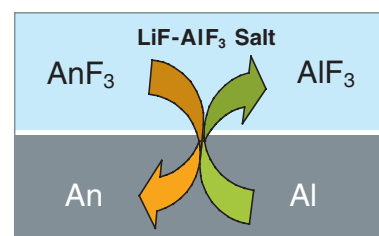
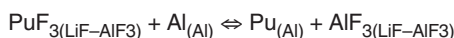

Fig. 166. Principle schematic of reductive liquid aluminum extraction.

This technique relies on separation by high-temperature liquid–liquid extraction, involving transfer from a molten salt to a liquid metal.

Liquid aluminum extraction (see Fig. 166) is the technique affording, to date, the highest potential, for the purposes of group partitioning of actinides, involving as it does a high decontamination factor, with respect to lanthanides.

Subsequent to dissolution of the ceramic fuel in a LiF–AlF<sub>3</sub> (15 mol.%) salt bath at 830 °C, contact between the salt and liquid aluminum allows a selective reduction of actinides to the metallic state, and their solubilization in the aluminum phase, whereas most fission products remain within the salt bath (see Fig. 167):



The scientific feasibility of Pu and Am coextraction, and the separation of these elements from lanthanides (involving separation factors higher than 1,000) was demonstrated in the laboratory, in 2003–2004 (see Figs. 167, 168). Further, actinide recovery rates higher than 99% should be achievable, using a limited number of extraction stages (two stages should be sufficient). A recent estimate of the distribution coefficient for

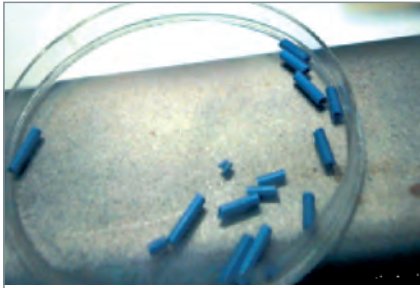

**Blue color, characteristic of trivalent plutonium**

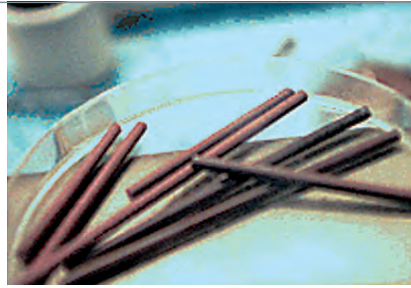

**Brown color, characteristic of lanthanides**

Fig. 167. Photographs of the salt, before (left), and after (right) extraction of the actinides.

curium indicates it stands at about the same value as for other actinides, thus allowing the feasibility to be anticipated, of coextracting curium together with the other actinides.

Further R&D investigations are still required, to arrive at a fully developed process (in particular as regards the conditions for the removal of other fission products, such as platinoids, zirconium, molybdenum, and cesium, or for the back-extraction of actinides from the liquid aluminum...).

For the purposes of the technical feasibility demonstration for this process, a molten salt–liquid metal contactor is undergoing technological development, and physicochemical charac-

terization investigations, as regards the properties exhibited by binary salt–metal systems, are being carried out concurrently, to gain the ability to predict the hydrodynamic behavior of such phases, in the mixing and settling compartments of this equipment, during mass transfers.

Concurrently with experiments, system studies are being carried out, for the purposes, on the one hand, of investigating the integration of the various steps into an overall process, and optimizing the proposed treatment flow-

sheets, in accordance with R&D findings; and, on the other hand, in order to ensure the availability of a tool allowing the comparative evaluation of the various recycling pathways proposed, with regard to targets, and constraints. For instance, on the basis of an initial flowsheet yielding five waste streams, an “improved” flowsheet has now been suggested: this minimizes reactant inputs, and involves internal recycling loops, potentially bringing the number of waste streams down to three, or even two. In this new configuration, the salt–metal liquid–liquid extraction process would yield a stream of process waste of broadly the same size as for an aqueous process, carrying out the same functions. These adjustments to the process chemistry are currently undergoing validation.

The ultimate waste yielded by this flowsheet consists of a fluoride salt, contaminated with fission products, metallic FPs in particular (platinoids + Mo). Investigations on the confinement of this type of waste have made it possible to demonstrate the feasibility of incorporating 15%, by mass, of such fluoride salt waste in a calcium-bearing vitrocrySTALLINE matrix. Investigations further highlighted the benefits afforded by such metal alloys as  $\text{Cu}_{89}\text{Sn}_{11}$  bronze, and the  $\text{Cu}_{30}\text{Ni}_{70}$  alloy, for the purposes of metallic fission product conditioning.

### Electrolytic separation

There are no instances, in the nonnuclear pyrochemical industry, of salt–metal contactors operating on a continuous basis, at high temperature. Thus, uncertainty as to how successful the development of such equipment may turn out to be, compounded by constraints related to the use of molten fluorides (high temperature, corrosiveness), calls for the investigation of one or more fallback routes; electrolytic separation is the most promising such route.

This process is particularly suitable for the treatment of metal fuels, and was put forward, in the 1980s, by the United States,

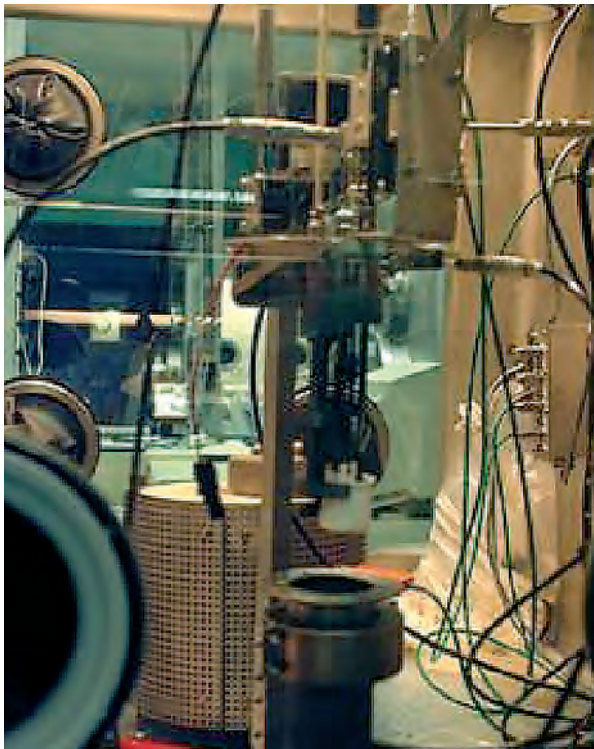

Fig. 168. High-temperature liquid–liquid contactor, used in glovebox conditions, in the ATALANTE facility.

under the aegis of the Integral Fast Reactor (IFR) program.<sup>1</sup> The US Argonne National Laboratory (ANL) devised an electrorefining treatment process for U–Pu–Zr fuel (electrolytic separation), using a molten LiCl–KCl medium at 500 °C, involving the simultaneous recovery of the uranium stream, over a solid, inert cathode, and of the uranium + transuranium elements stream over a liquid cadmium cathode (see Fig. 169).

The US teams demonstrated the scientific feasibility of recovering plutonium over a liquid cadmium cathode, and are currently investigating americium recovery [1].

CEA is likewise evaluating the potentials afforded by this separation technique. The scientific feasibility of the electrolytic recovery of plutonium, and americium over a liquid cadmium cathode was also demonstrated, in particular through experiments (at the scale of a few grams) carried out in the ATALANTE laboratories (see Fig. 170) [2]. However, the limited efficiency found in this experiment, accounted for by the conditions involved for electrolysis (low cathode current density), and use of an electrolyzer that had not been optimized, does not allow any conclusion to be drawn, as to the potentials afforded by this technique, for the purposes of the quantitative recovery of all actinides, involving adequate decontamination,

1. According to this concept, all actinides (U, Pu, minor actinides) would have been recycled (in the form of a uranium stream, and a uranium + transuranium elements stream), being incorporated into a metal fuel (zirconium-based alloy), to be used in a fast reactor, fuel treatment and refabrication being carried out at the reactor site. The discontinuation of the IFR program, in 1994, put an end to the associated treatment studies, however these are currently being taken up again, in the context of certain fourth-generation reactor concepts (in particular the metal fuel-powered, sodium-cooled fast reactor concept), by the United States, Japan, the Republic of Korea (South), and India.



Fig. 170. Americium-loaded cadmium cathode (test carried out in the C10 line, in the ATALANTE facility).

with respect to fission products. Moreover, predictive calculations have shown that the electrolysis step, by itself, would not allow the recovery of more than 99% actinides, with a sufficiently high decontamination factor, with respect to fission products. Thus, coupling this technique with a complementary extraction step would appear to be required, for the purposes of actinide multirecycling. At the same time, these tests have shown that cadmium is not, from the narrow standpoint of selectivity, the best cathode metal, with regard to effecting electrolytic actinide–lanthanide separation; other metals, such as aluminum, would seem to be more suitable.

Although launched fairly recently at CEA, the dedicated pyrochemical research program has allowed many results to be achieved, which, to a large extent, are proving encouraging. Nevertheless, a number of issues do still remain open, both as regards separation concepts, and their implementation. Major R&D efforts are still required, before more efficient recycling of actinides (whether yielded by dedicated transmutation systems, or fuels from the reactors of the future) can be contemplated, involving pyrochemical processes.

#### ► References

- [1] “Pyrochemical processes”, in Lester R. MORSS, Norman M. EDELSTEIN, Jean FUGER (eds.), Joseph J. KATZ (Honorary Editor), *The Chemistry of the Actinide and Transactinide Elements* (3rd edition), Springer, 2006, vol. 4, pp. 2691–2725.
- [2] CEA (Collective), *Les Déchets radioactifs à haute activité et à vie longue: Recherches et résultats – Loi du 30 décembre 1991 – Axe 1: Séparation et transmutation des radionucléides à vie longue*, Final Report, CEA Report CEA/DEN/DDIN/2005-568, December 2005.
- [3] *Clefs* CEA, No. 55, Summer 2007, “Nuclear Systems of the Future – Generation IV”.

**Jérôme LACQUEMENT,**  
Radiochemistry and Processes Department

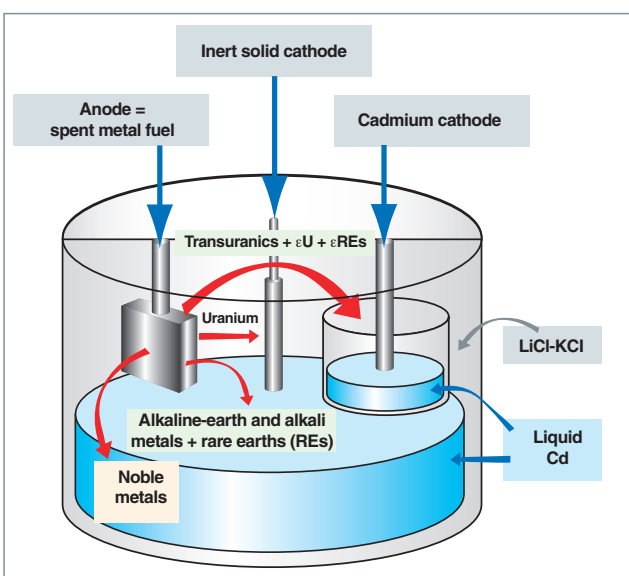

Fig. 169. Principle schematic of actinide recovery by electrorefining, using two cathodes in LiCl–KCl at 500 °C (ANL process).

## Radionuclide management strategies

Subsequent to its in-reactor dwell time, spent fuel contains:

- 94% uranium, and 1% plutonium, elements involving a high energy potential, which may be recovered for value-added purposes, and are indeed, in part, recycled (by way of example, for the purposes of generating the same amount of energy, 1,000 tonnes of such spent nuclear fuel is equivalent to about 23 million tonnes oil);
- 5% other radioactive elements, these currently forming the waste from energy production. A major fraction of these elements (4.6%) involve radioactive decay **half-lives\*** of less than 30 years, and no useful purpose is seen in seeking to bring down the amounts of such elements.

There thus remains 0.4% long-lived waste: 0.1% “minor actinides” (so called owing to the small quantities involved), in particular neptunium, americium, and curium; and 0.3% fission products. The radioactive half-lives involved, for these elements, range from several thousand years (e.g. americium) to several million years (e.g. neptunium). They thus cause a residual radioactivity, and heat release, extending over very long timespans. Their radioactivity yields emissions of a variety of radiations (alpha, beta, gamma), which could cause deleterious biological effects, should they come into contact with the human organism. **Radiotoxicity\***, i.e. the contribution from each element to such effects, in the event of their hypothesized ingestion, stands as the indication of the potentially hazardous character of radioactive waste.

At the outcome of the investigations carried out over the past 15 years, under the aegis of the French Act of 30 December 1991 on radioactive waste management research, the nominal solution selected, for long-lived, high-level waste, is reversible disposal in a deep geological formation, subsequent to a possible prior storage phase, for the purposes of allowing activity levels, and decay heat to come down, in the waste packages, once they have been suitably **conditioned\*** (see the DEN Monograph *Nuclear Waste Conditioning*).

One complementary pathway, for the management of such waste, involves carrying out the **transmutation\*** of certain radionuclides, to bring down the amounts, and harmfulness, of ultimate radioactive waste. Such transmutation entails, as a prerequisite, the separation of the radionuclides concerned. The investigations on partitioning and transmutation, initiated under the French Act of 30 December 1991, are being carried

forward under the subsequent Act of 28 June 2006 on sustainable radioactive material and waste management, with the purpose of investigating industrializable solutions, allowing a reduction in the amounts of high-level waste held in glasses, and enabling further advances as regards the recycling of materials contained in spent fuel.

It is chiefly with regard to long-lived radionuclides that such reduction, in the quantities held in waste, is being sought. To that end, these elements must first be extracted from spent fuel: this is the partitioning step. Once the radionuclides have been separated, two alternatives may be pursued:

- the separated elements could be conditioned, in a form specifically adjusted to cater for their physicochemical characteristics, to ensure their lasting confinement (see Box, below);
- or the separated elements could equally be destroyed, through their transformation into nonradioactive, or shorter-lived elements: this is the transmutation step.

The most effective way of ensuring such transmutation is to bombard these long-lived radionuclides with neutrons, such as are available in very large quantities inside nuclear reactors.

The three devices that may be considered, at first blush, to carry out this transmutation are thermal-neutron reactors (such as the current pressurized-water reactors operated by French national utility EDF), fast-neutron reactors, and installations involving the coupling of a particle accelerator and a subcritical, fast-neutron reactor (so-called “hybrid systems,” or “accelerator-driven systems” [ADSs]). Investigations have been carried out on transmutation in all three types of reactor.

Research work carried out at CEA has shown that transmutation in thermal-neutron reactors proves technically inefficient.

On the other hand, the characteristics exhibited by fast-neutron reactors, or **fast reactors\***, of the Phénix type, do allow minor actinide transmutation to be contemplated, using fuels bearing significant quantities of minor actinides (2.5–5%).

ADSs are reactors of an original, if complex type, affording potentials as dedicated transmutation reactors. Such potentials have yet to be demonstrated experimentally. Investigations are ongoing for that purpose, involving close collaboration both

## Should separated radionuclides be confined?

Some radioactive elements, once separated, may prove not to be readily transmutable, and an alternative must thus be proposed, aside from transmutation. The aim then becomes that of securing availability of conditionings, able to ensure the confinement, over very long timespans, in disposal conditions, of such radioactive elements, yielded by enhanced partitioning. Investigations at CEA have been concerned with the confinement of each one of the elements being investigated for partitioning purposes: Am, Cm, Np, I, Tc, Cs.

The principle selected, for the purposes of confining these elements, is to incorporate each one of these, separately, into a specific matrix, rather than incorporating all of them, simultaneously, into one and the same matrix, as per current practice, with the glass matrix, which ensures the confinement of all of the radionuclides held in the solutions yielded by treatment of spent fuels. By incorporating these elements singly, the choice of matrix may be optimized for that particular element, and the confinement performance achieved may be maximized. On the other hand, the matrices thus obtained are distinctive ones, for each of these elements, thus affording no such chemical flexibility as the glass matrix.

Dedicated investigations have been conducted, to seek novel materials, liable to act as very-long-term confinement matrices, for each of the separated elements. The outcomes vary, depending on the radioactive elements considered for confinement.

Iodine proves highly difficult to confine. The only matrix selected is lead–vanadium phosphate apatite, which does seem to exhibit satisfactory long-term behavior. Bringing to the industrial scale the synthesis process involved (reaction sintering under pressure) is a point that has yet to be evaluated, to achieve techni-

cal feasibility. As regards cesium, hollandite was selected as a possible confinement matrix, owing to its outstanding chemical durability, good irradiation behavior, and the simplicity of the fabrication process involved (natural sintering in air). For technetium, only a choice of matrix type has been made, i.e. metallic rather than oxide, while the other aspects (chemical durability, irradiation behavior, process) have not as yet been addressed.

As regards minor actinides, four high-performance matrix materials have been developed, while selection of the best conditioning has yet to be decided. Many positive scientific results have been obtained, with these four matrices: zirconolite, britholite, monazite–brabantite, and thorium phosphate-diphosphate. These matrices exhibit outstanding chemical durability, while the fabrication processes required (natural sintering in air) are simple enough to allow transposition to the industrial scale. Moreover, findings from initial experiments further show that the effects of self-irradiation on confinement properties should remain negligible.

While these “specific” confinement matrices do appear as satisfactory solutions, in scientific terms, their industrial deployment will undoubtedly be a complex, and costly undertaking. At the same time, the advances made, as regards our understanding of the long-term behavior of glasses, warrant a good confidence as to the ability of that matrix to ensure the confinement of all of the radionuclides yielded by spent fuel treatment.

Ultimately, the advantage afforded by such new, “separate” conditioning processes is not, as of now, truly proven. Should some separated elements turn out not to be amenable to transmutation, they would, as in current practice, be conditioned in glass.

with the French CNRS, and European partners. Since their performance, in terms of electric power generation, is limited, ADSs stand as a possible complement to power reactors.

The evaluation of a waste management solution may only proceed by reference to an overall perspective, taking in all nuclear energy cycle installations (fuel fabrication plants, reactors, spent fuel treatment plants...), not in the light of the performance achieved for just one of its components. For that purpose, “scenario” studies were undertaken: these bring together assumptions as to the evolution of installations over time, and are an essential tool, for the evaluation of the benefits from, and feasibility of, implementing partitioning and transmutation.

Scenario studies provide an overview of the cycle, and of the waste generated at various points in time, while simulating the operation of the various nuclear installations over several decades, starting with the existing situation. They make it possible to compare the potentials afforded by various scenarios,

with respect to reductions in waste radiotoxicity, and requirements for new installations, as compared to the current situation.

Starting with extant water reactors, the scenario involving a progression that provides for the gradual replacement of such reactors by fast reactors is the one that yields, realistically, the largest reduction in waste radiotoxicity. By their very principle, fast reactors yield little by way of minor actinides, and have the ability to transmute those they do generate, along with those yielded by current water reactors. The feasibility in principle of such a scenario, involving the use of fast reactors, is a settled issue.

In such a scenario, only the fraction of minor actinides not extracted from spent fuel (0.1% of these actinides, on the basis of the performance achieved for enhanced partitioning) forms the ultimate waste. The radiotoxicity, and decay heat exhibited by glasses are thus considerably reduced, contributing to opti-



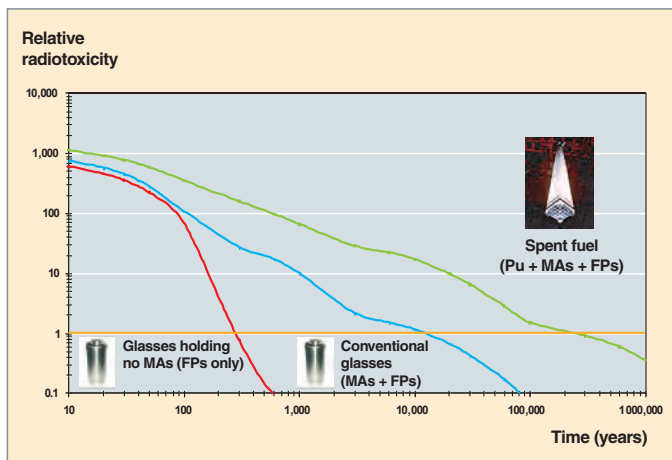

Fig. 171. The comparison of spent fuel radiotoxicity, and vitrified waste package radiotoxicity, with, and without minor actinide partitioning, shows the anticipated benefit, accruing from minor actinide transmutation. As may be seen, this allows a considerable reduction to be achieved as regards characteristic waste containment times. Disposal costs are likewise brought down, since dimensioning for this is determined by waste decay heat.

mization of the disposal option, by bringing down both the costs it entails, and the length of time over which it must ensure radionuclide containment (see Fig. 171).

Implementing such a scenario will only be feasible once fast reactors, and the new cycle installations become available.

The feasibility of transmutation, at the scale of an experimental fuel, has been demonstrated in the **PHÉNIX\*** reactor. Irradiation experiments will proceed, up to 2009, in that reactor, in particular for the purposes of complementing the data available, as regards transmutation. The aim will also be to draw up a balance of the results achieved, to allow transmutation experiments to be considered, at the assembly scale, in the future French pilot fast reactor, scheduled for 2020.

The deployment, at the industrial scale, of partitioning and transmutation will further entail that a spent fuel treatment plant be available, involving enhanced partitioning capability, together with fast reactors, allowing transmutation to be carried out. Such a deployment may be contemplated, to be gradually phased in from 2040 on.

**Dominique WARIN,**  
*Radiochemistry and Processes Department*

### Could retrieval of already vitrified waste be contemplated, to subject it to partitioning and transmutation?

Two pathways have been investigated, at CEA, for the purposes of extracting minor actinides, and long-lived fission products from already vitrified waste: one process at ambient temperature, involving dissolving the glass in an acid solution, after mechanically crushing it; and a high-temperature (melting, flux addition), then low-temperature (quenched, to enable thermo-mechanical fragmentation) thermal process, allowing the glass to be more readily dissolved in an aqueous phase. The second process would seem to be more amenable to extant nuclear cycle technologies. However, the industrialization of this complex process, involving as it does a number of steps, would require major development work, and entail the construction of several workshops, similar to the existing workshops at La Hague (France), involving high capital, and operating costs. On the grounds of these findings, it would not be realistic to retrieve long-lived radioactive elements from already manufactured glasses.



## How is transmutation to be carried out?

### The physical basis of transmutation

The principle of transmutation, as applied to the treatment of long-lived nuclear waste, involves modifying the nuclei of the radioactive elements concerned, to transform them into stable nuclei.

To that end, they must be bombarded with particles. A number of pathways have been explored, though only the one making use of the neutrons inside a reactor **core**\* has proved effective.

Owing to its lacking an electric charge, the neutron is, by far, the particle best meeting the desired criteria. At the same time, neutrons are “naturally” present, and available in great quantities inside nuclear reactors, where they are generated, allowing the **chain reaction**\* to be sustained, along with the associated production of energy.

The neutron–nucleus interaction results in two main types of reactions: reactions of neutron **capture**\* by the target nucleus, and of nucleus **fission**\*. As regards fission products, capture allows, as a rule, after a number of successive transformations, the yield of a stable nucleus. The typical example is that of technetium-99 (half-life: 210,000 years), which, through neutron capture, transforms into technetium-100, which has a very short half-life (15.8 seconds), this yielding, through  $\beta^-$  decay, ruthenium-100, which is stable (see Fig. 172).

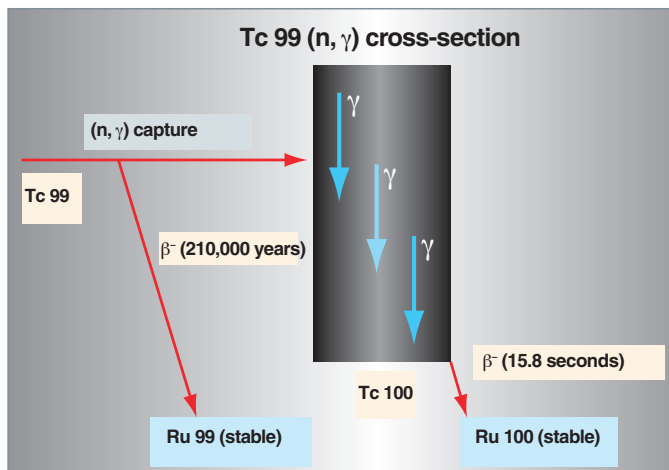

Fig. 172. Principle of technetium-99 transmutation.

As far as minor actinides are concerned, such capture reactions should be avoided, since they result in the formation of other actinides, involving radiotoxicities that are at least as great.

By way of example, americium-241, which has a radioactive half-life of 433 years, mainly transforms, through neutron capture, when subjected to irradiation, into americium-242, which, in turn, chiefly, and quite promptly, yields, through  $\beta^-$  decay, curium-242. The latter nuclide has a radioactive half-life of 163 days.

One might therefore assume, by way of an initial analysis, that such a process, involving the transformation of a long-lived element, Am 241, into a short-lived one, Cm 242, is a “useful” operation.

In fact, Cm 242 naturally transforms, through alpha decay, into Pu 238, which has a longer radioactive half-life ( $T_{1/2} = 88$  years), and so on through to lead.

The comparison of the evolutions, as a function of time, of the radiotoxicity of Am 241, and Cm 242, as set out in the figures below, shows that this operation is far from beneficial, quite the reverse.

By contrast, through fission, the nucleus splits, as a rule due to the impact from the incident neutron, into two fragments, the fission products, which mostly involve short radioactive half-lives (less than 30 years), ultimately yielding stable substances.

On average, fission product nuclei undergo four radioactive decays, involving half-lives not greater, as a rule, than a few years, before reaching stability. The associated activity, and radiotoxicity have virtually completely vanished, after 300 years.

This, quite obviously, is the pathway that should be promoted, for the purposes of actinide destruction, since, on the one hand, fission thus yields short-lived, and subsequently stable residues, involving a lower long-term radiotoxicity than the actinide thus destroyed; and, on the other hand, fission yields further neutrons, which may be used to destroy other waste materials, or help sustain the chain reaction, while yielding energy.

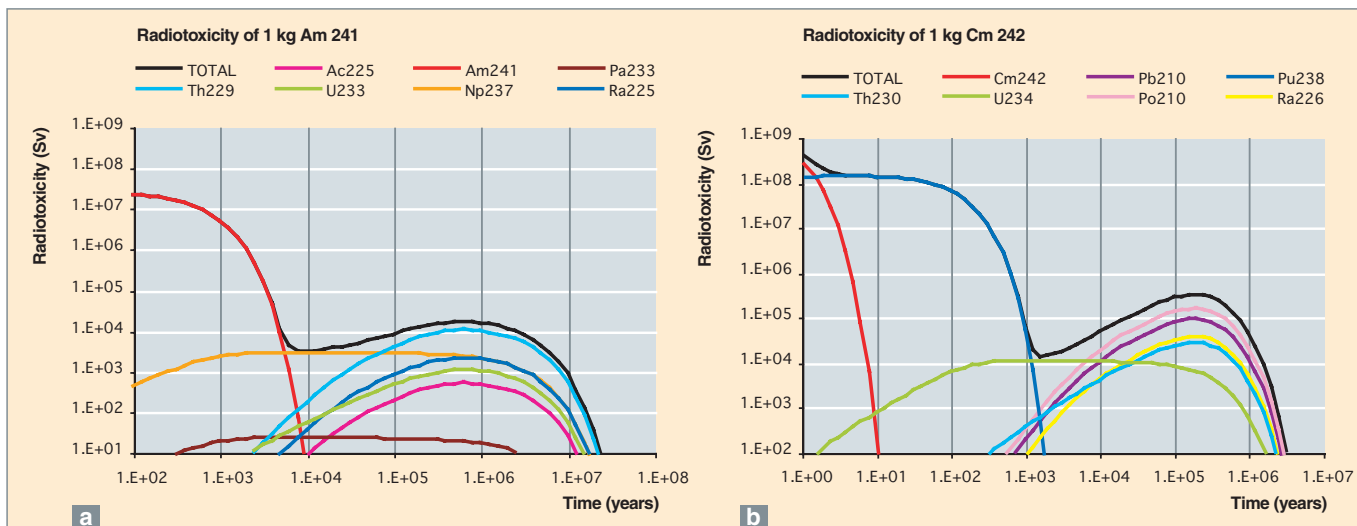
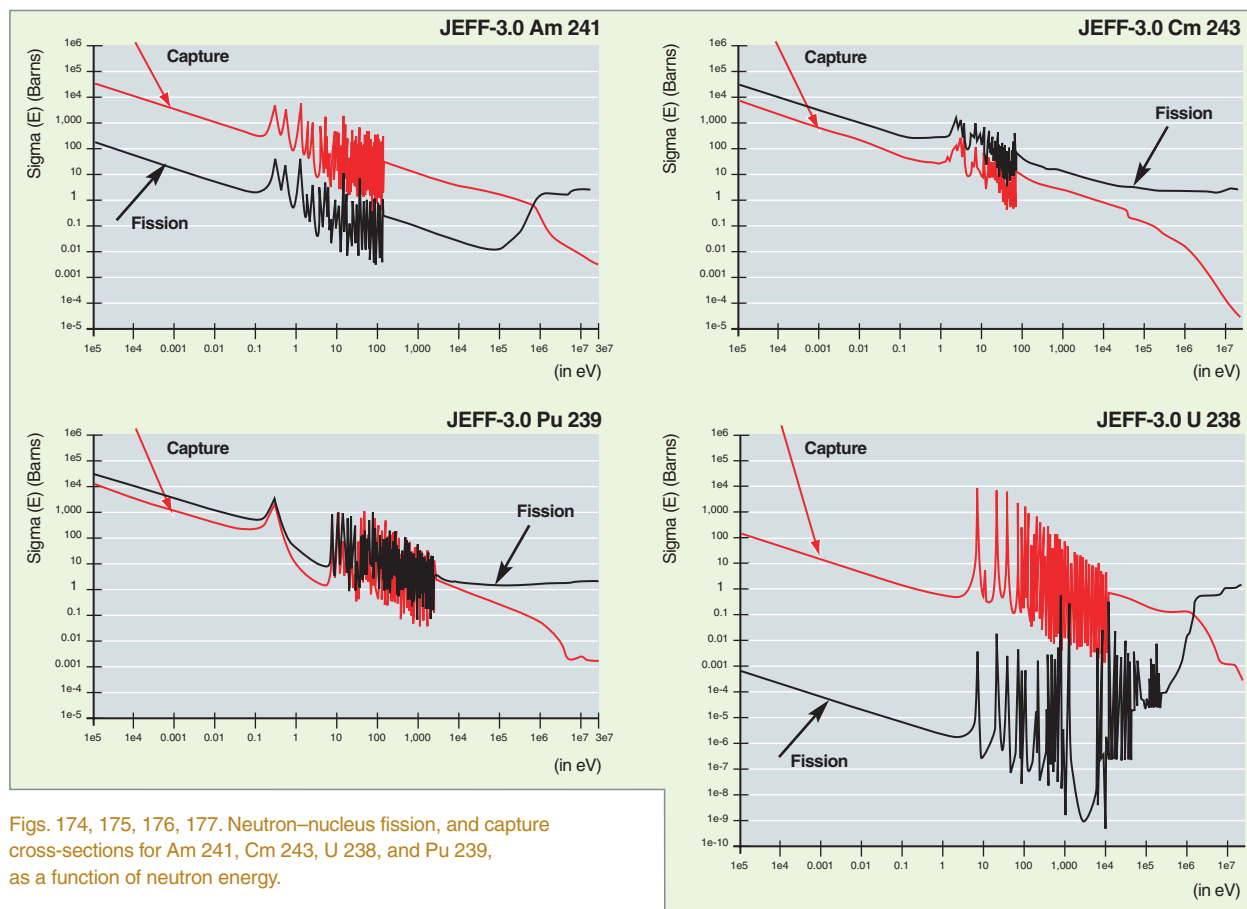

Fig. 173. a. Evolution of the radiotoxicity of 1 kg Am 241; b. Evolution of the radiotoxicity of 1 kg Cm 242.

## Neutronic characteristics of actinides

The ability to achieve an efficient transmutation process, with respect to actinides, thus depends on the competition between the two reactions, of **fission\***, and neutron **capture\***. The prob-

ability of occurrence, for each reaction, is characterized by the **cross-section\*** involved, for the isotope considered. An analysis of the way the corresponding cross-sections pan out, as a function of incident neutron energy, is thus essential, in this respect. By way of illustration, such data, taken from the JEFF-3 European nuclear data library, are set out, for Am 241, Cm 243, U 238, and Pu 239, in Figures 174–177.



Figs. 174, 175, 176, 177. Neutron–nucleus fission, and capture cross-sections for Am 241, Cm 243, U 238, and Pu 239, as a function of neutron energy.

In the thermal region (i.e. for energies lower than 0.1 eV), americium isotopes 241 and 243 prove very poorly fissile. The probabilities for neutron capture are 100–1,000 times higher than for fission. The same is true of Np 237. The even-numbered curium isotope Cm 244 likewise exhibits a similar behavior, the capture/fission ratio however being smaller (a factor 10 or so). Such isotopes are said to be “capturing” isotopes.

By comparison, the cross-sections involved for U 238 turn out to be markedly smaller, in terms of absolute values, than is the case for minor actinides. The substitution of uranium with such minor actinides will thus tend to raise the absorption rate, in the thermal region, thus bringing down the neutron flux level in that region, resulting in a major impact on core neutronic parameters, as will presently be seen.

Unevenly-numbered curium isotopes exhibit capture, and fission values that lie closer together. Probabilities for fission are 5–10 times higher than for capture. The aspects of the corresponding curves are quite similar, in terms of shape, to what is found for U 235. Absolute values, for the fission cross-sections, turn out to be slightly higher than those found for Pu 239. Such isotopes are so-called “fissile\*” isotopes.

In the **epithermal\*** region (i.e. for energies higher than 1 eV), a generally similar behavior is observed, apart from lower capture/fission ratios.

In a fast spectrum, the differential, for capturing isotopes, between capture, and fission probabilities remains large, up to the fission threshold, at energies around 1 MeV or so, however, overall, the capture/fission ratio is found to be markedly lower.

These findings are set out in numerical terms in Table 21, which shows mean cross-section values, integrated over representative neutron spectra, for various types of reactors – the neutron spectrum being defined as the energy distribution for the neutron population present in a given reactor. A “thermal” spectrum, for a **PWR\*** using UO<sub>2</sub> fuel, an “epithermal” spectrum for a PWR using MOX fuel, and a fast reactor (FR) spectrum are shown in Figure 178, below.

This elementary analysis allows the following points to be made:

- as regards actinides Np, Am, and Cm 244:
  - in PWRs, where the thermal neutronic region is preeminent, these isotopes behave as neutron poisons. They prove detrimental in terms of neutron balance, and are essentially transmuted into other actinides;
  - in fast reactors, the capture/fission ratio is reduced by a factor 5–10, when the spectrum switches from PWR (thermal, or epithermal) to FR conditions. Reactors of the latter type are thus more efficient, for the purposes of transmuting minor actinides by way of direct fission;

Table 21.

Actinide capture and fission cross-sections (in barns*), and $\sigma_c/\sigma_f$ ratio.									
Isotope	Slow-neutron reactor (PWR)			Epithermal-neutron reactor (MOX PWR)			Fast-neutron reactor (FR)		
	$\sigma_f$	$\sigma_c$	$\alpha = \sigma_c/\sigma_f$	$\sigma_f$	$\sigma_c$	$\alpha = \sigma_c/\sigma_f$	$\sigma_f$	$\sigma_c$	$\alpha = \sigma_c/\sigma_f$
U 235	38.8	8.7	0.22	12.6	4.2	0.3	1.98	0.57	0.29
U 238	0.103	0.86	8.3	0.124	0.8	6.5	0.04	0.30	7.5
Pu 238	2.4	27.7	12	1.9	8	4.2	1.1	0.58	0.53
Pu 239	102	58.7	0.6	21.7	12.2	0.6	1.86	0.56	0.3
Pu 240	0.53	210.2	396.6	0.7	24.6	35.1	0.36	0.57	1.6
Pu 241	102.2	40.9	0.40	28.5	9	0.3	2.49	0.47	0.19
Pu 242	0.44	28.8	65.5	0.5	12.3	24.6	0.24	0.44	1.8
Np 237	0.52	33	63	0.6	18	30	0.32	1.7	5.3
Np 238	134	13.6	0.1	38.5	4	0.1	3.6	0.2	0.05
Am 241	1.1	110	100	0.8	35.6	44.5	0.27	2.0	7.4
Am 242	159	301	1.9				3.2	0.6	0.19
Am 242 m	595	137	0.23	126.6	27.5	0.2	3.3	0.6	0.18
Am 243	0.44	49	111	0.5	31.7	63.4	0.21	1.8	8.6
Cm 242	1.14	4.5	3.9	0.96	3.45	3.6	0.58	1.0	1.7
Cm 243	88	14	0.16	43.1	7.32	0.2	7.2	1.0	0.14
Cm 244	1.0	16	16	1	13.1	13.1	0.42	0.6	1.4
Cm 245	116	17	0.15	33.9	5.4	0.2	5.1	0.9	0.18

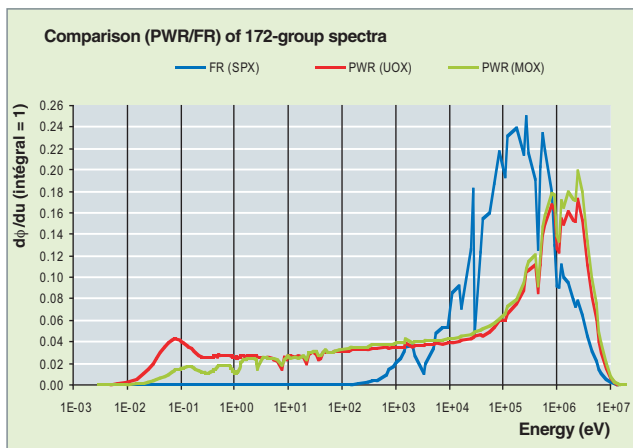

Fig. 178. Comparison of neutron spectra, for a pressurized-water reactor, and a sodium-cooled fast reactor.

- as regards isotopes Cm 243, and 245, the capture/fission ratios involved are similar, in PWRs as in FRs. These isotopes are mostly transmuted into short-lived fission products.

To sum up, a fast spectrum makes it possible to minimize “interfering” capture reactions, while promoting fission reactions, for all of the actinides, this accounting for its so-called “omnivorous” character. In a thermal spectrum, minor actinides chiefly undergo neutron capture reactions, except for curium-243, and -245. This phenomenon tends to yield increasingly heavy isotopes.

Such an analysis remains an elementary one, insofar as it is based only on the impact of the first neutron interaction. Nevertheless, it does highlight the inherent advantage afforded by the fast neutron spectrum.

Arriving at a proper evaluation of the overall efficiency of transmutation entails that the influence be considered, of the successive reactions involved, during in-reactor irradiation.

## Overall efficiency of in-reactor transmutation

For a standard irradiation, in reactors of PWR and FR types, disappearance rates, for the element considered, expressed in terms of percent of the mass initially present, are set out in Table 22, below. **Fission rates\***, integrated over irradiation time, are also shown. These fission rates cover the contributions to fission not just of the mother isotope, initially present, but also of the daughter isotopes yielded in the course of irradiation.

Analysis of these findings allows the following main points to be made:

- in standard in-reactor irradiation conditions, it is not feasible to achieve full destruction of the elements considered, in a single irradiation pass. Recycling must be provided for (a number of successive recycles, each one lasting several years, will even be required, if a fission rate close to 100% is desired);
- owing to the contributions from fissile isotopes generated in the course of irradiation, the fission rate-to-disappearance rate ratios, integrated over irradiation time, are higher, compared to the same ratios, relating to the initial isotope only;
- fission rates achieved in fast reactors are higher, by a factor 2–6, than those achieved in PWRs;
- in PWRs, as transmutation, for the elements considered, chiefly occurs by way of successive neutron captures, production of higher elements is markedly enhanced. This point shows up in Figures 179, and 180, comparing the evolution under irradiation of americium-243, according to the spectrum: fast, or thermal.

In a fast spectrum, the yield of higher isotopes remains, in any event, limited, compared to the production occurring in a thermal spectrum. This is true of the yield of higher curium isotopes, but equally with regard to other elements, of higher mass number, such as Bk or Cf, which raise very serious

Table 22.

Disappearance rates, and fission rates, for elementary irradiations.				
	PWR MOX 60 Gwd/t Flux = $2.5 \cdot 10^{14}$ n.cm <sup>-2</sup> .s <sup>-1</sup> Irradiation time = 1,500 EFPD		EFR FR 140 Gwd/t Flux = $3.4 \cdot 10^{15}$ n.cm <sup>-2</sup> .s <sup>-1</sup> Irradiation time = 1,700 EFPD	
	Disappearance rate (%)	Fission rate (%)	Disappearance rate (%)	Fission rate (%)
Np 237	46	4	63	24
Am 241	70	10	69	24
Am 243	65	6	63	15
Cm 244	44	16	50	27

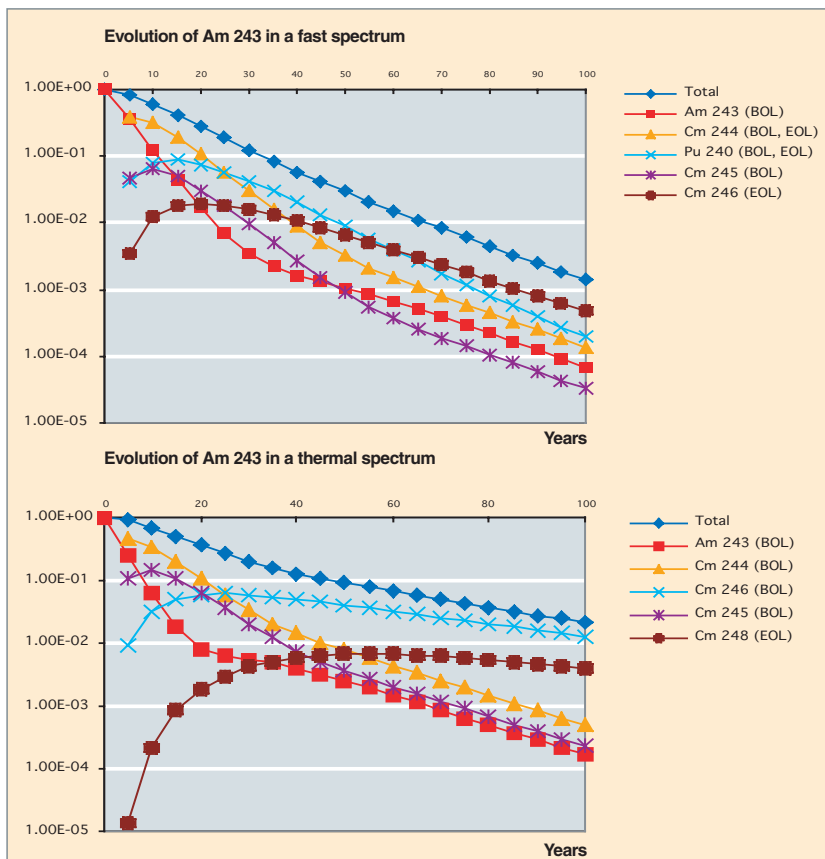

Figs. 179 and 180. Comparison of americium-243 evolution in a fast reactor, and in a thermal reactor.

issues of **criticality\***, and radiation protection, for fuel cycle operations.

Such physical characteristics allow the transmutation of minor actinides to be contemplated, in fast-neutron systems, involving full actinide recycle, with no buildup of higher isotopes, their concentrations tending to reach an equilibrium value. This transmutation mode may not be transposed to water reactors, these entailing, as a requisite, that curium be partitioned, and not recycled, to preclude an ongoing buildup of higher isotopes, with incidences on fuel cycle operations, owing in particular to a larger resulting neutron source.

A second, altogether theoretical approach, complementary to the one outlined above, involves evaluating the number of neutrons, and hence the neutron balance, involved in transforming one initial isotope (and all the isotopes yielded by successive reactions, from that initial isotope) into stable isotopes, or fission products.

## The neutron balance

A method for the evaluation of the neutron balance involved, over the complete transmutation of one type of nucleus or another, has been developed at CEA, for the purposes of arriving at numerical estimates of the transmutation potential afforded by the various types of fission reactors, whether **critical\***, or **subcritical\***, coupled to a neutron source. This method is based on the following simple principle:

For a given neutron flux (flux level, and spectrum), the evolutions undergone by an initial nucleus, of the species selected, are tracked, along all of its possible decay lines under irradiation, a fission standing as the termination of a decay line (see Fig. 181).

Each of these decay lines, and branches is weighted by a probability of occurrence, this depending, through its position in the decay tree, on the capture, and fission cross-sections, these in turn depending on the neutron spectrum chosen, flux level, and natural decay constants.

Finally, at every step, a count is made, of neutron consumption, and production. The numbers obtained are weighted by the various, previously derived probabilities, and then summed, with appropriate sign conventions, across all of the possible decay lines, to yield an overall value of the neutron consumption,  $D$ , required to achieve complete fission of the initial nucleus, and all its daughter nuclei, yielded under irradiation.

Table 23 sets out the values for  $D$ , for nuclei occurring singly, and for typical isotopic compositions, allowing for a margin of 0.3 neutron per fission, to take into account neutron loss owing to leakage, or sterile captures:

It will be seen that, in a fast spectrum, minor actinides, taken singly, are all net neutron producers, over their irradiation time, while such is not the case, in a thermal spectrum.

The ensemble of all transuranium elements (Pu + MAs) stands as an unambiguous neutron producer, in a fast spectrum, whereas the balance is negative in a thermal spectrum.

The definition of  $D$  for fission products is slightly different, since these undergo no fission. The coefficient  $D$  will stand, fairly closely, for the number of captures required, to transform a long-lived fission product into a stable isotope of another chemical element (such as to enable it to be readily separated), allowing for a few second-order corrections, due to the

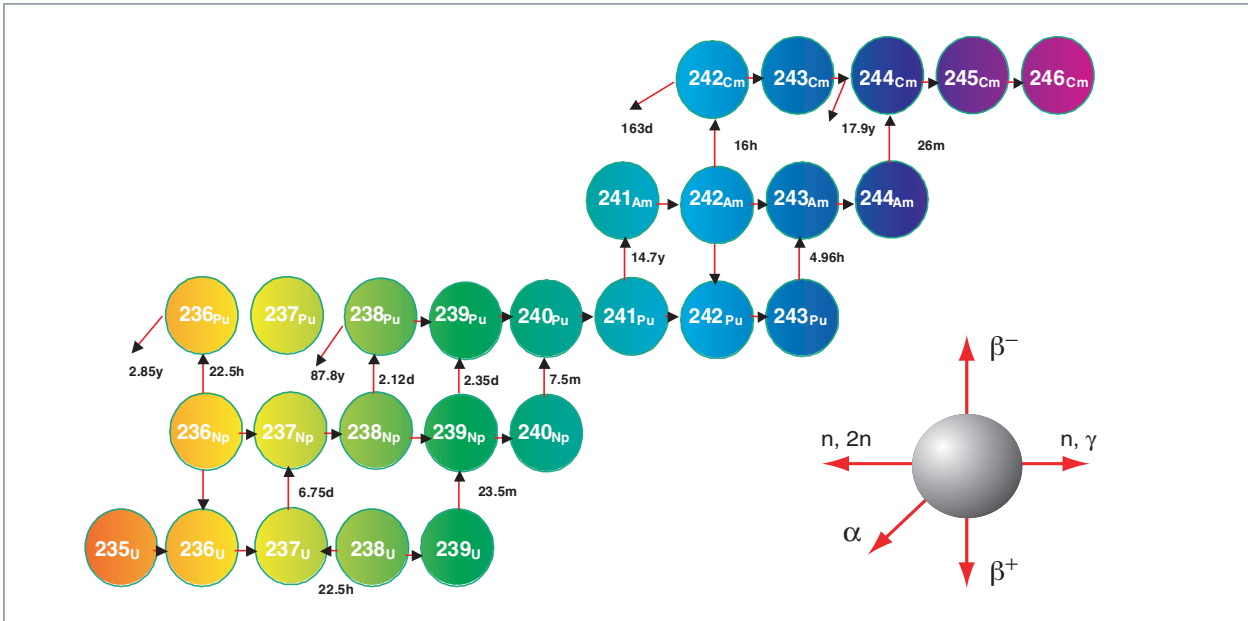

Fig. 181. Mother–daughter relationships between actinides. Arrows indicate the possible evolutions of an actinide nucleus, under the combined effects of neutron capture, and radioactive decay.

competition between captures, and decays. The parameter  $D$  turns out to have closely similar values, in PWRs, and fast reactors. The efficient transmutation of such nuclei would entail, at least, adequate utilization of such neutron surpluses as may arise from the transmutation of the Pu + MAs, or even making use of external neutron sources (ADS hybrid systems).

As may be seen, fast reactors exhibit the most favorable characteristics, in terms of neutron balance, for the purposes of transuranium element transmutation, in particular with regard to minor actinides. Obviously, this is in no way to discount the issues that may arise, in other respects: impact on safety parameters, on fuel cycle requirements, efficiency in terms of radiotoxic inventory reductions, or yet other criteria. These issues will be addressed further on.

Table 23. Values for  $D$  (in neutrons per fission): i.e. number of neutrons required to achieve the destruction of a heavy nucleus, by fission.  $D < 0$ : neutron consumption;  $D > 0$ : neutron production.

	Thermal reactor	Fast reactor
Np 237	- 1.4	+ 0.3
Am 241	- 1.4	+ 0.3
Am 243	- 0.7	+ 0.3
Cm 243	+ 1.6	+ 1.8
Cm 244	+ 0.4	+ 1.1
Cm 245	+ 2.0	+ 2.2
All minor actinides	- 1.2	+ 0.4
Pu + minor actinides	- 0.2	+ 0.9
Long-lived FPs (elements)	- 2.3	- 2.2
Long-lived FPs (isotopes)	- 0.6	- 0.6

## The impact of actinide transmutation on core physics

It is not possible to load arbitrarily large amounts of minor actinides into the core of a reactor, whether it be of the PWR, or fast reactor type. The chief limitation relates to their impact on the core's neutronic behavior, its stability depending on the core's **reactivity\*** and kinetic coefficients:

- the void effect, which determines the reactor's stability, in the event of a loss-of-coolant accident;
- the reactivity effect linked to an increase in fuel temperature (**Doppler\*** effect), this determining the reactor's stability during a power excursion;

- the **delayed neutron\*** fraction (effective beta), this determining the reactor's "responsiveness," i.e. the response time involved, during any variation in reactivity;

- the loss of reactivity due to fissile material depletion, in the course of fuel irradiation.

The effects of introducing extra amounts of minor actinides into a fast reactor core are shown in Figure 182.



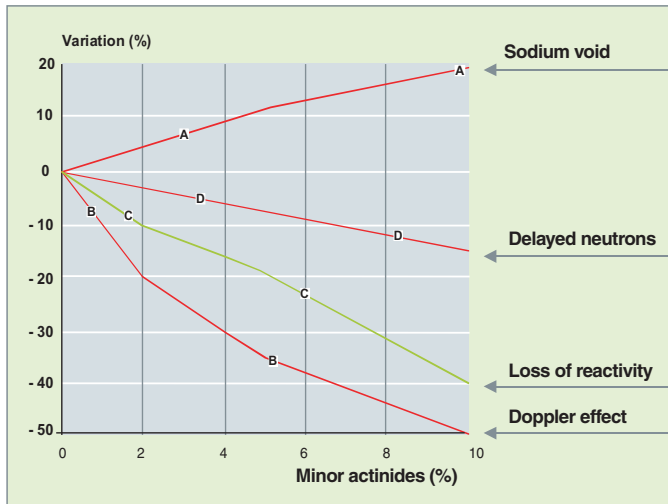

Fig. 182. Relative variations of core parameters, as a function of the minor actinide fraction held in fuel.

It will be seen that, with regard to three parameters, out of the four considered, the introduction of minor actinides into the fuel results in unfavorable effects that are far from negligible. For instance, adding 4% minor actinides to the fuel induces a 10% increase in sodium void effect. As regards the Doppler coefficient, which determines, in part, core stability during accidental transients, the impact is greater still, as a fall of some 30% is observed with respect to that coefficient, for that same amount of added minor actinides.

As regards **effective beta\***, standing as this does for the delayed neutron fraction, sensitivity is less pronounced, since the variation involved is smaller than 10%.

Loss of reactivity over the cycle is the only quantity showing a favorable effect, as this also falls, allowing a reduction in fuel Pu content.

In conclusion, if acceptable core physics parameters are to be preserved, maximum allowable minor actinide contents, in a fast reactor, will stand at around:

- 3% of fuel heavy nuclei, for large cores of the Superphénix (SPX) or European Fast Reactor (EFR) type;
- 5% of fuel heavy nuclei, for small Phénix-type cores; or for large gas-cooled fast reactor cores, owing to less stringent constraints as regards the key parameter, of coolant void coefficient.

As far as PWRs are concerned, the above considerations show that transmutation does not result in efficient heavy nucleus destruction, rather it causes their buildup. Moreover, introducing minor actinides into PWR fuel tends to impair core reactivity coefficients. Finally, introducing minor actinides into

PWRs entails increased enrichment, in terms of U 235, or Pu, which is not without its economic downside. On these grounds, minor actinide transmutation in a thermal-neutron flux, in PWRs, is no longer being contemplated.

## The various minor actinide recycling modes

If the minor actinides are incorporated into the fuel, this is known as “homogeneous recycling,” maximum allowable contents then being determined, as has just been seen, by compliance with criteria related to core physics parameters.

If, by contrast, the minor actinides are held in targets, positioned at the core periphery, this is termed “heterogeneous recycling,” impairment of core parameters then being much reduced. Maximum allowable contents, in such targets, then depend more on considerations relating to, and impacts on, target fabrication, and treatment operations, rather than considerations pertaining to core physics parameters.

## Impact of actinide transmutation on the fuel cycle

The aim here is not to cover the fuel cycle as a whole, rather the point will be to determine the quantities (activities, sources, power yield as charged into the reactor, and as discharged) which may influence the available possibilities, and operating modes, as regards the fabrication, handling, and treatment of fuel assemblies, or targets holding the elements subjected to transmutation. This determines the recycling mode, or even the feasibility of recycling certain elements. Table 24 sets out the values for decay heat,  $\gamma$  dose rate at 1 m from the source, and neutron source, for various “theoretical” fuels, bearing the same mass of minor actinides. These values are expressed relative to oxide fuel for an EFR core.

It will be seen that the largest variations arise at the fuel fabrication stage. Indeed, subsequent to irradiation, the contribution from heavy isotopes is “blocked out” by the dominant contribution from fission products. Significant variations are found only for decay heat, this increasing by a factor close to 2, for fuel with 2.5% neptunium, by a factor 3, or 6 for americium-, or curium-based fuel. In like manner, neutron emission rises by a factor 4, or 8 with americium-, or curium-bearing fuels.

As regards fresh fuel, adding neptunium, to the tune of 2.5% by mass of heavy isotopes, causes no change in thermal power, activity, or neutron emission levels. Only the  $\gamma$  dose rate increases, by a factor of around 4, owing to the presence of protactinium-233 (this remaining in equilibrium with neptunium-237), which is a hard (around 300-keV)  $\gamma$ -ray emitter.

As regards americium-bearing fuel, the steep rise in the  $\gamma$  source, and associated dose rate (by a factor 80) is mainly due

Table 24.

Impact of minor actinide recycling on the fuel cycle.			
Variation relative to the reference EFR MOX fuel.			
Actinide content	2.5% Np	2.5% Am	2.5% Cm
<b>Fabrication</b>			
Thermal power	× 1	× 4	× 12
γ dose	× 4	× 80	× 500
Neutron emission	× 1	× 2	× 1,700
<b>Treatment</b>			
Thermal power	× 2	× 3	× 6
γ dose	× 1	× 1	× 1
Neutron emission	× 1	× 4	× 8

to the contribution from neptunium-239, this standing in equilibrium with its mother nuclide, americium-243.

When curium is introduced, the effects are markedly stronger, with source dose rate increasing by a factor close to 500, owing to the contributions from curium-243 and curium-244, both strong hard-g-ray emitters. The rise in neutron emission is even more significant (by a factor 1,700), chiefly due to the spontaneous decay of curium-244.

Thus, while the homogeneous recycling of neptunium does appear quite a feasible proposition, the impact, in terms of  $\gamma$ , and chiefly neutron sources that would result from the introduction of curium means in-reactor recycling of this element would prove highly problematical.

As regards americium, the situation involved stands half way. Homogeneous recycling of this element would entail major development work, with respect to current technologies, and, in particular, would require a shielded fabrication line. The heterogeneous pathway would make it possible to avoid degrading standard fuel characteristics, while concentrating issues on a smaller material stream.

## Should long-lived fission products undergo transmutation?

The in-reactor transmutation of selected long-lived fission products (technetium-99, iodine-129, cesium-135) raises numerous issues:

- these nuclides are sheer neutron consumers;
- the cross-sections (and hence the transmutation rates) involved are small, in a fast spectrum ( $< 0.5 \text{ barn}^*$ ), as indeed in a thermal spectrum (a few barns, at most);

- the two above considerations entail that only those isotopes designated for transmutation be loaded into the reactor, whereas these are often minority nuclides (apart from Tc 99), relative to the other isotopes they are associated with, for which transmutation is not desired. This then would entail carrying out isotopic separation, prior to transmutation...;
- the chemical form liable to be introduced into the reactor is not necessarily the pure element (especially as regards readily fusible, or volatile substances, e.g. iodine, and cesium).

As regards the first point, the transmutation of long-lived fission products in PWRs stands as an unfavorable option, since the neutron balance is very depressed. The position is more favorable with fast reactors. Hybrid, ADS-type reactors afford a better potential, owing to the contribution to the neutron balance provided by their external neutron source.

As to the second point, owing to the small cross-sections exhibited by these isotopes, an effective compromise may be achieved, by combining the high neutron flux levels prevailing in fast reactors, with an adjustment to the neutron spectrum in the targets involved, in order to maximize cross-sections. The performance of such a recycling mode, in a fast reactor, has been evaluated. This shows that transmutation of technetium-99, and iodine-129 may be contemplated, however this would involve low transmutation rates. Irradiation times of 20–30 years would be required, to transmute one half of the initial mass.

As regards Cs 135, its capture cross-section is altogether too small to warrant its in-reactor transmutation being contemplated.

### Transmutation of minor actinides in dedicated systems (ADSs)

Dedicated systems for the transmutation of minor actinides (accelerator-driven systems [ADSs\*]) comprise a subcritical reactor, coupled to an external source of neutrons, as yielded by means of an accelerator.

The subcritical character of the reactor makes it possible to introduce into it large minor actinide loads, while ensuring reactor control, and safety, which is a favorable aspect with regard to transmutation.

The complexity of such systems does not allow considering them, economically, as power reactors.

Development of these systems involves the design of specific, high-tech components:

- an accelerator, delivering an intense beam of high-energy protons: the choice of accelerator type (a linear accelerator) has been decided, however the reliability issue is not resolved as yet;
- a **spallation\*** target, yielding high-energy neutrons under the action of the protons supplied by the accelerator (and, depending on target design, a window, isolating the target from the accelerator): a reference pathway has been proposed (a liquid target, using the lead–bismuth eutectic, and featuring a window), however the issue of materials behavior has yet to be addressed (corrosion from the liquid metal, irradiation, gas generation);
- a reactor core, operating in subcritical mode, in a fast spectrum.

As a world first, the main components (external neutron source, subcritical core) were successfully assembled, for the purposes of very-low-power neutronics investigations, inside the MASURCA experimental reactor, at Cadarache (France), for the MUSE experiment, conducted by CEA and the French CNRS.

The spallation target was successfully demonstrated, in the context of the MEGAPIE experiment, carried out at the Paul Scherrer Institute (Switzerland).

Concurrently, engineering studies, carried out at the European level (PDS–XADS program) confirmed the absence of any unacceptable issues, as regards the feasibility in principle of the ADS system, for power levels of around 100 MWth. The ongoing GUINEVERE program will seek to demonstrate, experimentally, the ability to control ADS behavior in the static, and dynamic regimes. However, many technological barriers do still remain, and, to overcome these, investigations are being carried out under the aegis of the EUROTRANS European integrated project, coming under the European Union's 6th Framework Program (FP6). These systems, which are not as yet available, will certainly prove more complex, and costly than critical fast-neutron systems.

## Irradiation experiments to support development of transmutation concepts

To support the studies on transmutation concepts, as described above, a major fuel and target materials investigation program has been set in train, at CEA, to demonstrate the technical feasibility of the transmutation modes being considered, in terms of fabrication, and irradiation behavior.

This “materials” program is backed by an extensive irradiation program, as summarized in Table 25, on the following page.

The PROFIL–R, and M irradiation experiments, currently under way in the French Phénix reactor, have the purpose of yielding information on nuclear data, and transmutation performance. These experiments involve inserting isotope samples into containers (see Fig. 183). These containers, about 50 in number, are stacked into one or more pins, these in turn being positioned inside a standard assembly. A reference pin is likewise characterized, before, and after irradiation, for the purposes of enabling a comparison to be made.

Post-irradiation analysis of these samples, of such pure isotopes as Am 241, Np 237, Pu 238, Am 243, allows the capture cross-sections, or (n, 2n) cross-sections to be arrived at, by way of the observed concentrations of isotopes of mass number  $A + 1$ , or  $A - 1$ . To ascertain the effect of the spectrum, two irradiations are carried out: one, PROFIL–R, in a standard fast-reactor neutron spectrum, the other, PROFIL–M, in a modified spectrum. The analyses of isotopic compositions, subsequent to these irradiations, will further allow computed transmutation performance figures, as outlined above, to be validated.

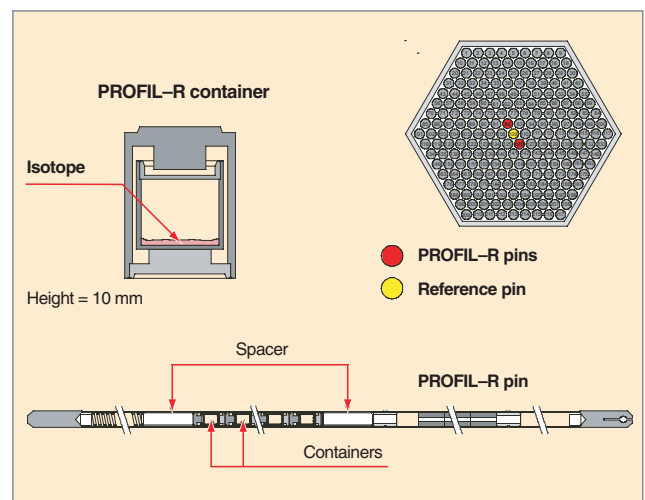

Fig. 183. Characteristics of the PROFIL experiments.

Table 25.

The experimental irradiation program launched at CEA to investigate the technical feasibility of transmutation.				
Topic	Type	Name	Reactor	Status
<b>General-purpose irradiations</b>				
Neutronic data	Separated isotopes	PROFIL-R and M	Phénix	Under way
	Structural materials	QUASAR, OLIPHANT, MEMPHIS	Phénix	Completed
Fuels/compounds	Oxides, nitrides	Amboine, Bora-Bora	BOR-60	Completed
	Nitrides, carbides	NIMPHE	Phénix	Completed
	Nitrides	CONFIRM	HFR	Completed
Matrices	On UO <sub>2</sub> carrier	T2, T3	HFR	Completed
	On UO <sub>2</sub> carrier	THERMET, TANOX	SILOE	Completed
	On UO <sub>2</sub> carrier	MATINA	Phénix	Completed
<b>Homogeneous transmutation</b>				
Actinides	Np, Am oxide	SUPERFACT-1	Phénix	Completed
Actinides	Np oxide	TRABANT 1	HFR	Completed
Actinides	Np, Am, Cm metal	METAPHIX-1, 2 and 3	Phénix	Under way
Actinides	Am + Np	GACID Phase 1 (pin)	Joyo	2007-2012
Actinides	Am + Np + Cm	GACID Phase 2 (pins)	Joyo	2007-2014
Actinides	Am + Np + Cm	GACID Phase 3 (assembly)	Monju	2009-2020
<b>Heterogeneous transmutation</b>				
Actinides	Np, Am oxide	SUPERFACT-1	Phénix	Completed
Actinides	Am + matrix	T4, T5	HFR	Completed
Actinides	Am + moderator	ECRIX (B and M)	Phénix	Under way
Actinides	Am + matrices	CAMIX-COCHIX	Phénix	Under way
MA blankets	Np, Am + Cm on UO <sub>2</sub> carrier	HELIOS capsule	HFR or OSIRIS	Design stage
Long-lived FPs	Tc, iodine	T1, T2, PROJECT1	HFR	Completed
Long-lived FPs	Tc + moderator	ANTICORP-1	Phénix	Under way

In homogeneous mode, in a fast reactor, the technical feasibility of transmutation, for the minor actinides americium, and neptunium was demonstrated by the SUPERFACT-1 irradiations, to be complemented by the information yielded by the METAPHIX experiment, carried out in Phénix.

Transmutation of curium is addressed by just one experiment, METAPHIX, owing to the very considerable difficulties involved in handling this radionuclide.

As regards the heterogeneous mode, in fast reactors, the T4 experiment, carried out in the European HFR reactor (Netherlands), demonstrated the feasibility of americium transmutation. Technical feasibility is presently in sight, through the experiments currently under way in the core of Phénix: ECRIX-B, and H, for americium. Post-irradiation examinations of experiments carried out in Phénix (MATINA, CAMIX-COCHIX) will allow the choice of materials, and concepts, to be optimized.

With regard to the transmutation of fission products, examination of the ANTICORP-1 experiment should make it possible to confirm the technical feasibility of Tc 99 transmutation.

Experimental feedback from the SUPERFACT-1 irradiation (see Fig. 184) further yields first-rate qualification, to support the minor actinide-bearing blanket concept, currently being investigated, as a suitable transmutation concept for fourth-generation fast reactors.

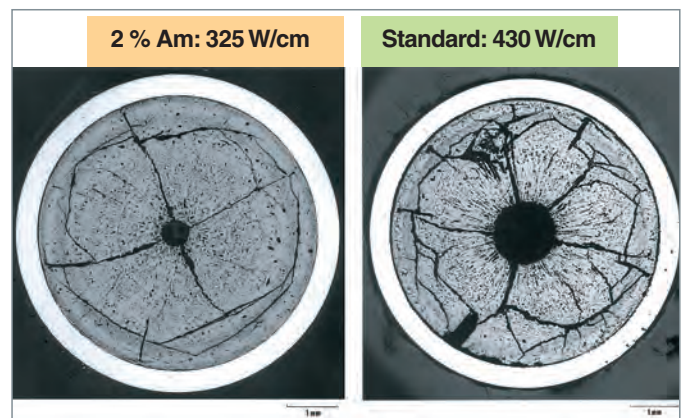

Fig. 184. Microstructure of a fuel pellet irradiated in the Phénix reactor (SUPERFACT-1 experiment). Compared views, with, and without americium.

The examination of pellets bearing 2% americium evidences irradiation behavior similar to that found for standard fuels (see Fig. 184).

If investigations of transmutation at a significant scale are to be carried forward, investigation of a complete assembly, inside a fast reactor core, is seen as indispensable. Such an experiment, requiring as it does the fabrication of pins holding several percent minor actinides, and availability of a suitable power reactor, is being carried out under the aegis of an international program, going by the name GACID, bringing together JAEA (Japan), DOE (USA), and CEA.

This program should allow the technical feasibility of transmutation to be demonstrated, step by step, in a fast reactor, starting with Am + Np-bearing pins, through to a complete assembly, holding a Np + Am + Cm mixture, to be irradiated in the Monju reactor (Japan).

## Partitioning and transmutation scenarios

The evaluation of a waste management solution may only proceed by reference to an overall perspective, of the fuel cycle as a whole (fabrication, reactors, treatment, storage, disposal), not in the light of the performance achieved for just one of its components. For that purpose, scenario studies, simulating the various hypotheses, as regards the evolution over time of a nuclear power fleet – comprising reactors, and cycle plants – are an essential tool, for the evaluation of the benefits from, and feasibility of, implementing partitioning and transmutation.

Two types of scenario are considered:

- so-called “equilibrium” scenarios, involving situations that have stabilized, both with respect to the type of nuclear fleet envisaged, and isotopy of the materials considered, this requiring a number of recycles, and thus many years. This type of scenario, rather theoretical in nature, affords the advantage of highlighting the benefits, and drawbacks of the strategies being investigated;
- transition scenarios, dealing with the switchover from current situations, as regards nuclear power fleets, to those ultimately aimed for. Bearing in mind that actual situations involve nothing but a succession of transient phases, this type of scenario affords the advantage of pinpointing the consequences, and implications of implementing a given strategy.

Under the aegis of the French Act of 1991 on radioactive waste management research, many scenarios were investigated. By way of illustration of the anticipated contribution from transmutation, a set of scenarios at equilibrium is outlined in the following paragraphs. These scenarios were all computed for a

reactor fleet of installed electric power equivalent to that of the current French fleet, with a yearly output of 400 TWh.

A number of plutonium, and minor actinide management modes are considered:

- monorecycling of Pu only, in MOX fuel, in PWRs (this being the current situation in France);
- multirecycling of Pu in fast reactors (FRs);
- multirecycling of Pu, and minor actinides in fast reactors.

The assumptions made, for the purposes of the study, are the following:

- the quantities of radionuclides consigned to waste are restricted to the sole losses incurred during the various cycle operations;
- plutonium, and minor actinide recovery rates, in spent fuel treatment operations, are set at 99.9%;
- fuel is deemed to be kept 7 years outside the reactor (5 years’ cooling time, prior to treatment; and 2 years subsequent to fabrication).

The performance achieved, for each of these three scenarios, is compared with that involved by the open cycle, as set out in Table 26, on the following page.

MOX monorecycling does not allow any significant gains to be achieved, in terms of radiotoxic inventory, compared with the open cycle, owing to the increased actinide yield, in particular as regards americium, and curium.

Multirecycling of Pu only results in gains by a factor of about 5–10.

Only the full recycle of all actinides allows very significant gains to be achieved, in terms of mass, and waste radiotoxicity. The downside is a larger minor actinide inventory, circulating across the cycle.

These benefits, in terms of downsizing mass and radiotoxic inventories in waste, are combined with a significant reduction in the thermal load involved for waste packages. Figure 185 shows the evolution over time of this decay heat yielded by waste packages, according to the various scenarios investigated.

Once the falloff in the contribution from fission products has occurred, after 300 years’ cooling time, the partitioning of actinides – plutonium, americium, and, to a lesser extent, curium – makes it possible to achieve gains by a factor 100 in waste package decay heat, compared to the open cycle.

Table 26.

Actinide inventory across the cycle, annual actinide yield in waste, and gains in terms of radiotoxicity, compared to the open cycles.				
	PWR open cycle	PWR monorecycling (MOX)	FR Pu multirecycling	FR Pu + MA multirecycling
<b>Inventory across the cycle (tonnes)</b>				
Pu	35	150	820	800
Np	2.4	6	2	4
Am	1	4	5	32
Cm	0.5	2	1	8
<b>Mass present in waste (kg/year)</b>				
Pu	10,500	7,000*	70	57
Np	740	760	200	0.3
Am	290	740	1,400	2.5
Cm	150	370	100	0.6
<b>Gains in terms of radiotoxic inventory, compared to the open cycle</b>				
After 1,000 years	1	1.2	5	210
After 10,000 years	1	1.5	10	150

\* Pu stored pending treatment.

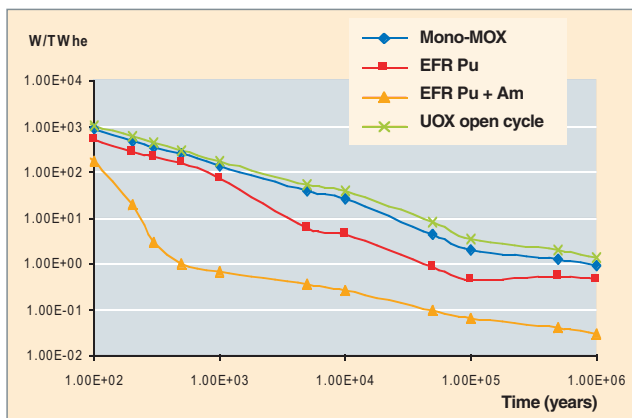

Fig. 185. Decay heat, as a function of time, according to various minor actinide management scenarios. Multirecycling in fast reactors allows a very significant gain to be achieved, with direct consequences as regards size, cost, and complexity for the disposal facility for the remaining waste.

Which factor 100 is to be set against the factor 10 or so to be achieved, should recycling of Pu only in fast reactors be considered.

Such downsizing of decay heat could allow a smaller disposal repository volume to be provided for, to a varying extent, depending on the concept opted for.

This complementary aspect, between partitioning and transmutation strategies, and geological disposal strategies, to which is associated the role for, and benefits afforded by, storage, stands at the core of the scenario studies currently being carried out, under the aegis of the new French Act of 2006 on sustainable radioactive waste and material management.

#### ► Bibliography

CEA (Collective), *Les Déchets radioactifs à haute activité et à vie longue: Recherches et résultats – Loi du 30 décembre 1991 – Axe 1: Séparation et transmutation des radionucléides à vie longue*, Final Report, CEA Report CEA/DEN/DDIN/2005-568, December 2005.

Alain ZAETTA,  
Reactor Research Department

## General conclusion

**P**artitioning actinides from spent fuel? Sure enough, this is already being done, with the PUREX process, for uranium, and plutonium! The validity of such a strategy, allowing as it does substantial savings, in terms of fissile materials, is presently bolstered, due to skyrocketing uranium prices, and owing to the fact it does considerably facilitate the subsequent management of fuel cycle waste. The treatment, and recycling of major actinides is bound, in any event, to become indispensable, with the advent of fast reactors. Be that as it may, the PUREX process, which currently allows the partitioning of major actinides (uranium, plutonium), is yet amenable to further improvements, extensions, and variants. At the outcome of a sustained research and development effort, over the past half-century, nuclear chemists are now in a position to make a whole range of tools available to the industry, making possible a more precise management of heavy nuclei, through enhanced partitioning processes, and processes for the group partitioning of all actinides, both major, and minor.

These new extraction processes may be seen as extensions of the PUREX process, since they complement it, while in no way departing from its technical basis. Group partitioning, due to be initially implemented, in the near future, with the COEX™ process, and extended, looking further ahead, by the GANEX process, could yield considerable gains in terms of proliferation resistance. Enhanced partitioning, in turn, would allow consigning to vitrification the fission products only, with concomitant major reductions in terms of thermal load in glasses, and of the containment time required, in geological disposal conditions. Waste disposal would thus be greatly simplified, and the facility involved would then prove far less costly, and possibly more acceptable to public opinion also. However, in order to turn such benefits to best advantage, it becomes necessary to know what is to be done with the actinides thus partitioned. The best utilization will probably involve recycling them: fast reactors indeed have the ability to incinerate these materials.





# Glossary–index

**Absorbed dose:** the quantity of energy absorbed at a given point, per unit mass of material (whether inert, or living matter). This is expressed in **grays\*** (Gy): 1 gray corresponds to an absorbed energy of 1 joule per kilogram of material. **125, 161, 162.**

**Actinides:** rare-earth elements, having atomic numbers ranging from 89 to 103. This group corresponds to the filling up of subshell 5f. Actinides exhibit very closely similar chemical properties to one another. **11–32.**

**Activation:** the process whereby certain nuclides, particularly within structural materials in reactors, are made **radioactive**, through **neutron** bombardment, or bombardment by other particles. **39, 79–80, 101, 126.**

**Activity:** 1. for a radioactive substance: the number of **disintegrations** per unit time within a **radionuclide**, or a mixture of radionuclides. This is expressed in becquerels (Bq). 1 becquerel corresponds to 1 disintegration per second;

2. in a chemical reaction: the chemical activity of a given species corresponds to the active concentration for that species. Within a solution, interactions of electrostatic type arising between the various species present reduce their reactivity potential. The concentration term must thus be corrected, by way of a coefficient, lower than unity, known as the “activity coefficient.” Substituting activity for the actual concentration of the chemical species makes it possible to use the mass action law. **21, 28, 43, 67, 71, 75–81, 142.**

**ADS:** acronym for “accelerator-driven system”: a hybrid reactor, involving the coupling of a subcritical core with a high-energy proton accelerator. The latter yields, by way of **spallation\*** reactions, the complement of neutrons required to sustain the chain reaction. **87, 90, 151, 160–163.**

**Airlift:** a device allowing circulation of a liquid, by injecting air at the base of a vertical pipe. The lower density of the mixture thus generated results in the formation of a higher fluid column than would have obtained without any air present, allowing gravity flow to occur. The flow rate achieved depends on the flow rate of injected air. **64.**

**Alpha:** see **Radioactivity\***. **13, 43, 44, 76, 141, 142.**

**ANDRA:** The French National Agency for Radioactive Waste Management (Agence nationale pour la gestion des déchets radioactifs). **5, 8, 79.**

**Assembly:** in the core of a water reactor, fuel **rods\*** are grouped into bundles exhibiting adequate stiffness, precisely positioned within the reactor core. It is that structure as a whole, comprising from 100 rods or so to several hundred rods, loaded as a unit into the reactor, which is known as a “**fuel element\***,” or “assembly” **35, 37–39, 45, 46, 80, 91–95, 163–165.**

**ATALANTE:** a nuclear facility at CEA’s Valrhô Center, dedicated to research and development on spent fuel treatment, from fuel dissolution through to waste vitrification, involving the use of actual radioactive products. High-performance scientific equipment – both analytical and process equipment – set up in an environment featuring containment enclosures (**gloveboxes\***, **shielded line\***) allows the investigation of treatment processes (**hydrometallurgi-**

**cal\***, or **pyrometallurgical\***), and the fabrication of compounds for the purposes of actinide recycling tests. **9, 15, 18, 27, 84, 89, 105–106, 114, 122, 124, 125, 127, 131, 136–138, 140, 143, 149, 150.**

**Back-extraction (or stripping):** see **Extraction\***. **19, 27, 35, 56–60, 66, 67, 83, 84, 130, 132.**

**Barn:** the unit used to measure **cross-sections\*** (1 barn =  $10^{-24}$  cm<sup>2</sup>). **156, 157.**

**Bidentate:** see **Polydentate\***. **27, 28, 85, 111.**

**Burnup:** strictly speaking, the “burnup fraction” refers to the percentage of heavy atoms (uranium, and plutonium) that have undergone **fission\***, over a given time interval. The term “burnup” is commonly used when evaluating the amount of thermal energy, per unit mass of **fissile\*** material, yielded in reactor, from the time of loading, to discharge of the fuel; it is then expressed in megawatts–day per tonne (MWd/t). **Discharge burnup\*** is the value for which the fuel assembly, after several irradiation cycles, must be finally discharged. **36, 40, 47, 86, 92, 93, 99.**

**BWR:** boiling-water reactor. **34.**

**Capture:** the capture of a neutron by a nucleus. Capture is said to be “radiative,” if it is immediately followed by emission of gamma radiation. It is said to be “**fertile\***,” if it yields a **fissile\*** nucleus. **7, 13, 39, 94, 155–158, 160, 162, 163.**

**Chain reaction:** a sequence of nuclear **fissions\***, in the course of which the **neutrons\*** released cause further fissions, which in turn yield further neutrons causing further fissions, and so on. **155.**

**Cladding:** an envelope, encasing the fuel material, having the purpose of ensuring fuel isolation and mechanical strength inside the reactor core. **37, 39, 41, 45, 92, 97.**

**Complexation:** the ability, exhibited by a chemical species, to form stable groups with one or more **ligands**, by way of electrostatic interactions. **23–31, 67, 108, 114, 117–119.**

**Conditioning (waste):** conditioning covers all of the successive operations that must be carried out in order to turn waste into a stable, safe form, allowing its subsequent management, whether it be by way of **storage**, **transmutation**, or **disposal**. **33, 44, 53, 71–73, 75, 79, 81, 149, 152.**

**Conversion:** the chemical transformation of uranium, for the purposes of **enrichment\***, **storage\***, or nuclear fuel fabrication. By extension, the term is used likewise for the other **actinides\***. **35, 36, 71–73, 83–85, 90, 93, 94, 104, 128, 135–142, 145, 147.**

**Core:** the central region in a nuclear reactor, holding the fuel assemblies, coolant, and moderator, within which the **chain reaction\*** takes place. **155, 161, 163.**

**Critical:** a system is said to be critical when the number of **neutrons\*** released by **fission\*** processes inside it is equal to the number of neutrons disappearing through absorption, and leakage. In that case, the number of fissions observed, over successive, equal time intervals, remains constant. **Criticality\*** involves a precise equilibrium, between neutron production, through fission, and neutron losses, through absorption, and leakage. **36, 48, 49, 73, 137, 151, 163.**

**Criticality:** the characteristic state of a mass of material containing fissile elements, and, as the case may be, other elements, in such a configuration – composition, proportions, geometry – that a **fission chain reaction\*** may be self-sustaining within the material. **36, 44, 48, 59, 62, 63, 66, 137, 159.**

**Cross-section:** the measure of the probability of interaction between a particle and a target nucleus, expressed in **barns\*** (1 barn =  $10^{-24}$  cm<sup>2</sup>). In the case of the **neutron\***, for instance, this defines its probability of interaction with nuclei in the materials involved by the various core components. The cross-section is a measure of the probability of occurrence for a given reaction, between incident particles (e.g. neutrons) and a target (e.g. uranium nuclei). In nuclear reactors, a distinction is made, in this respect, chiefly between various neutron-induced reactions: fission, capture, elastic scattering. **155, 156, 162.**

**Decontamination factor:** the ratio between the quantity of a given impurity in the initial product, and in the endproduct, in a purification operation. This factor makes it possible to express quantitatively the operation's efficiency. **56, 59, 73.**

**Delayed neutrons: neutrons\*** released by **fission\*** fragments, with a delay, on average, of a few seconds after fission has occurred. Though accounting for less than 1% of neutrons released, they ultimately allow, by way of this temporal shift, reactors to be controlled. See also **Effective beta\***. **160, 161.**

**DIAMEX:** Diamide Extraction. **10, 69, 88, 89, 103, 109–111, 113, 118–127.**

**Disposal** (of nuclear waste): a disposal facility is an installation where waste is held, with no notion of retrieving it at a later date. Retrieval would nonetheless be feasible, in the reversible disposal case (see also **storage\***). **9, 33, 34, 44, 53, 79–83, 101–104, 151–153, 166–167.**

**Disproportionation** (or dismutation): the process whereby a single chemical species, initially occurring in oxidation state  $n$ , divides into two species in oxidation states higher, and lower than  $n$ , the two (or three) species then coexisting. **20–23, 26, 131.**

**Distribution coefficient** (or partition ratio): the ratio between the concentrations for one element, or one chemical species, distributed across two phases (e.g. an organic, and an aqueous phase) that are put in contact, and assumed to have reached thermodynamic equilibrium. **57–59, 129, 149.**

**Doppler** (effect): in neutronics: the broadening of neutron absorption resonances, due to the thermal agitation of the target nuclei. This effect contributes to the stability of a nuclear reactor, by bringing down core reactivity as core temperature rises. **160, 161.**

**Dose:** a general term, used to refer to the quantity of radiation, or energy absorbed by a specific mass of material. **125, 161, 162.**

**Effective beta:** the **delayed neutron** fraction; this is expressed, as a rule, in terms of percent millirhos (pcm). Some of the fission products formed inside the reactor core yield neutrons, this production sometimes involving a delay that may be as long as several tens of seconds, after fission. These neutrons make a marginal contribution to the neutron balance, however it is by means of these neutrons that the **chain reaction\*** can be controlled, and stabilized. **161.**

**Effluent: waste\***, in liquid or gaseous form, forming the residue from a chemical treatment. In certain cases, such unwanted residues are released into the environment; another option, widely taken up by the nuclear energy industry, is to separate out the toxic fraction, and condition this in a suitable matrix, allowing the remainder to be released, without involving any significant harm to the environment. **35, 45, 52, 53, 58, 71, 72, 75–78, 80, 81, 88.**

**Enrichment:** a process which, in the case of uranium, allows, by various means (gaseous diffusion, ultracentrifugation, selective laser excitation), an increase in the concentration of (fissile) **isotope\*** 235, relative to isotope 238, which is predominant in natural uranium. **39, 161.**

**Epithermal** (neutrons): neutrons having energies in the 1 **eV\***–20 keV range (approximately), thus endowed with a velocity higher than that of **thermal neutrons\***. In this energy region, neutron–nucleus interaction **cross-sections\*** are affected by the presence of resonances, and, as a result, may undergo variations of several orders of magnitude. 157.

**EXAFS** (extended X-ray absorption fine structure): see **XAS\***. **15, 18, 25, 27, 114, 116, 117.**

**Extractant:** a molecule exhibiting a particular chemical affinity for a given chemical species, thus allowing its separation in a mixture of phases. **10, 13, 14, 16, 35, 67, 88, 103, 108–113, 115, 116, 118–120, 124, 126–133.**

**Extraction** (solvent): an operation involving the use of the difference in chemical affinity exhibited by one species, with respect to complexing agents in the organic, and in the aqueous phase respectively, to effect the transfer of that species from one phase to the other. By convention, extraction corresponds to transfer from the aqueous to the organic phase, **back-extraction\*** (stripping) to the reverse operation. **19, 26, 27, 33–35, 54–60, 64–71, 83, 102–132, 148.**

**Fast neutrons: neutrons\*** released at the time of fission, traveling at very high velocity (20 000 km/s). They have energies of around 2 million **electronvolts\*** (2 MeV). **8, 37, 46, 87, 91, 92, 141, 153, 157, 158, 160, 163.**

**Fast reactor** (FR): a reactor using no **moderator\***, in which most fissions are caused by fast **neutrons\***, i.e. neutrons exhibiting energies of the same order as that they are endowed with when yielded by fission. **37, 39–41, 87, 88, 91–94, 99, 141, 142, 157–166.**

**Fertile:** term used to refer to a material the nuclei of which yield, by neutron absorption, **fissile\*** nuclei. This is the case of uranium-238, which yields plutonium-239. A material is said to be **sterile\***, when this does not occur. **8, 13, 33, 37, 39.**

**FIMA (fission per initial metal atom):** a unit of **burnup\*** for nuclear fuels, expressed in terms of the fraction of fissions occurring in a population of heavy-metal atoms. The correspondence with specific burnup (MWd/tM), which is the preferred measure used by reactor operators, stands at 1% FIMA  $\approx$  9,500 MWd/tM. This may be compared with the nominal burnup for PWR UO<sub>2</sub> and MOX assemblies, which currently stands at 52,000 MWd/tM (5.5% FIMA). **41, 99.**

**Fissile** (nucleus): a nucleus liable to undergo **fission\*** through **neutron\*** absorption. Strictly speaking, it is not the so-called “fissile” nucleus that undergoes fission, rather it is the compound nucleus formed subsequent to a neutron capture. **8, 13, 33, 37, 91–94, 103, 157.**

**Fission:** the splitting of an atomic nucleus into two fragments. This transformation, which is a particular case of radioactive decay, occurring for certain heavy nuclei, releases a considerable amount of energy, with concomitant emission of neutrons, and gamma radiation. Fission of so-called “**fissile\***” heavy nuclei may be induced by collision with a neutron. **7, 11, 13, 14, 39, 41, 155–160.**

**Fission products: nuclides\*** yielded either directly, by nuclear **fission\***, or indirectly by the **decay\*** of fission fragments. **7, 13, 35, 36, 39–41, 52, 55–57, 79, 88, 89, 101, 131, 153, 162.**

**FR:** fast reactor. **37, 39–41, 87, 88, 91–94, 99, 141, 142, 157–166.**

**Fuel:** the chief constituent material, in the **core\*** of a nuclear reactor, containing **fissile\*** elements sustaining a **chain reaction\*** within the material. [7](#), [37–39](#), [91–95](#).

**Fuel cycle:** the ensemble of steps undergone by nuclear fuel. The cycle includes ore extraction, concentration of the fissile material, **enrichment\***, fuel element fabrication, in-reactor use of these elements, treatment, recycling, and the conditioning, and disposal of the **radioactive\*** waste yielded by such treatment. [7](#).

**Fuel element:** see **Assembly\***. [95](#), [99](#), [141](#).

**GANEX** (Group Actinide Extraction): a chemical process for the group extraction of actinides. [10](#), [89](#), [103](#), [104](#), [126–133](#).

**GFR:** gas-cooled fast reactor. [91–94](#), [103](#), [141](#).

**GIF** or “**Gen IV**”: commonly used acronym, or designation, for an international collaboration (the Generation IV International Forum) set up for the purposes of developing fourth-generation nuclear systems. [8](#), [87](#), [89](#), [91](#), [140](#).

**Glovebox:** an enclosure inside which equipment may be operated, while remaining isolated from the operator. Actuation is effected by means of gloves, fixed in leaktight manner around apertures in the enclosure wall. The enclosure is, as a rule, kept at a lower pressure than ambient, to ensure radioactive substance containment. [9](#), [73](#), [149](#).

**Half-life:** the time required for one half of the radioactive atoms initially present to disappear from natural causes, through radioactive decay. [13](#), [126](#), [151](#), [155](#).

**Hot cell**, or **shielded line:** a heavily shielded cell, set up in a high-activity laboratory, inside which high-level substances are handled, by means of remote handling equipment. [105](#), [106](#), [110](#), [122](#), [123](#), [126](#), [137](#), [162](#).

**Hydrometallurgy:** a category of processes used for the purpose of extracting metals from compounds, subsequent to their dissolution in an aqueous phase. Hydrometallurgical processes are used, in particular, to extract uranium from uranium ore, and to partition actinides from spent nuclear fuel. [9](#), [101–134](#).

**Irradiated fuel:** fuel assemblies taken out of a nuclear reactor, after a time of useful energy production. Also known as “spent fuel.” [7](#), [39](#).

**Isotopes:** forms of one and the same chemical element, for which the nuclei have the same number of protons, but different numbers of neutrons. [8](#), [9](#), [11](#), [13](#), [39](#), [156–164](#).

**Lanthanides:** rare-earth **elements\***, having atomic numbers ranging from 57 to 71. This group corresponds to the filling up of electron subshell 4f. Lanthanides exhibit very closely similar chemical properties to one another, and very similar to those exhibited by actinides. Actinide–lanthanide separation, in spent nuclear fuel, sets a major challenge. [10](#), [11](#), [15–17](#), [55](#), [102](#), [109](#), [112](#), [117](#), [118](#), [124](#), [148–150](#).

**Ligand:** a chemical grouping which is considered for its ability to form bonds within **complexes\***. [15](#), [16](#), [21](#), [23–28](#), [72](#), [108–119](#).

**Major actinides:** uranium, and plutonium heavy nuclei, present, or generated within nuclear fuel. [11–32](#).

**MELOX:** a plant operated by Areva, set up at Marcoule (southern France), for **MOX\*** fuel fabrication. [7](#), [85](#), [141](#), [142](#), [143](#), [145](#).

**Minor actinides:** heavy nuclei, yielded, inside a reactor, by successive neutron captures, from nuclei in the fuel. The isotopes chiefly involved are neptunium (237), americium (241, 243), and curium (242, 244, 245). [11–32](#), [101](#).

**Monodentate:** see **Polydentate\***. [27](#).

**MOX** (mixed oxides): a mixture of (natural, or depleted) uranium oxide, and plutonium oxide. [7](#), [34](#), [39](#), [47](#), [72](#), [73](#), [83](#), [84](#), [141–143](#), [165](#), [166](#).

**NMR:** nuclear magnetic resonance. An analytical technique allowing information to be gained as to the chemical environment of a given element. [18](#), [114](#).

**Nuclear waste:** a residue, not amenable to further use, yielded by nuclear energy operations. [7–9](#), [33–36](#), [44](#), [79–82](#), [101–104](#), [148–153](#).

**Partitioning:** strictly speaking, in the **PUREX\*** process, this refers to the splitting, in the first cycle, of the uranium, and plutonium production streams. More broadly, in spent nuclear fuel **treatment\***, “partitioning” refers to the **separation\***, for **recycling\*** purposes, of **major actinides\*** – and, by extension, to that of all **actinides\*** – from the remainder, which is then designated as **waste\***. [7–10](#), [35](#), [36](#), [45](#), [53](#), [57–59](#), [67–69](#), [71](#), [88–89](#), [99](#), [101–131](#), [141](#), [146–148](#), [151–153](#), [159](#), [165–167](#).

**Pearson:** according to R. G. Pearson, the stability of **complexes\***, formed between acids and bases, may be predicted by ranking these acids and bases by hardness: hard acids (small, not highly polarizable) preferentially bond with hard bases, whereas soft (large, polarizable) acids bond with soft bases. [15](#), [26](#), [108](#), [117](#).

**Pellet:** a small cylinder of uranium- or plutonium-based ceramic, or ceramic involving other actinides, used as nuclear fuel. [37](#), [40–42](#), [92](#), [93](#), [142–145](#), [165](#).

**Phénix:** a prototype sodium-cooled **fast reactor\***, operated at the Marcoule site (southern France). [90](#), [92](#).

**Plutonium:** an element generated through neutron capture in uranium, inside nuclear reactor cores. The unevenly-numbered **isotopes\*** are **fissile\***, plutonium consequently being a recoverable nuclear material, for value-added purposes, e.g. for use in the form of **MOX\*** fuel. [7–167](#).

**Polydentate:** term used to refer to a ligand having the ability to set up several bonds (see **Monodentate\***, **bidentate\***, etc.). [110](#).

**Potential radiotoxicity** (of a given quantity of radionuclides, e.g. in waste): potential radiotoxicity, defined as the product of the **radionuclide inventory\***, multiplied by the ingestion dose factors for these radionuclides, is an indicator of the harmful potential of this quantity of radionuclides, in an accident situation. [72](#), [101](#), [102](#), [125](#), [126](#).

**Proliferation:** the uncontrolled dissemination of military nuclear technologies, or of nuclear materials used by such technologies. [8](#), [83](#), [86](#), [87–89](#), [103](#), [138](#), [140](#), [167](#).

**PUREX:** a **hydrometallurgical\*** spent fuel treatment process, currently used on an industrial basis to extract from such fuel the uranium, and plutonium still recoverable, for value-added energy purposes. The process separates these two elements from minor actinides, and fission products, which are deemed to be waste. [7–9](#), [33–85](#).

**PWR:** pressurized-water reactor. [34](#).

**Pyrochemistry:** high-temperature (several hundred degrees Celsius) chemistry. Pyrochemistry involves neither water nor organic molecules, rather it involves the use of liquid metals, and molten salts. [10](#), [90](#), [147–150](#).

**Pyrometallurgy:** the extraction of metals from compounds, by a **pyrochemical\*** route. [10](#), [90](#), [147–150](#).

**Pyrophoric:** this refers to a material liable to ignite spontaneously in air. [20](#), [98](#), [142](#), [143](#).

**Radioactivity** (radioactive): the property, exhibited by certain natural or artificial elements, of spontaneously emitting  $\alpha$  or  $\beta$  particles, or  $\gamma$  radiation. More broadly, this term is used to refer to the emission of radiation concomitant with the **decay\*** of an unstable element, or **fission\***. 7–167.

**Radiolysis**: the decomposition of molecules by ionizing radiation. 10, 13, 44, 60, 61, 125, 131.

**Radiolytic species**: products yielded by the **radiolysis\*** of water by ionizing radiation. These fall into two categories: radical species ( $e^-_{aq}$ ,  $\Sigma OH\dots$ ), and molecular species ( $H_2$ ,  $O_2$ ,  $H_2O_2\dots$ ). The radiolytic yields associated to the production of the various species depend on the nature of the radiation involved, owing to the associated linear energy transfers. 10, 110, 140.

**Radionuclide**: an unstable isotope of an element, which spontaneously decays, or undergoes fission, with a concomitant emission of radiation. 7–167.

**Radionuclide inventory**: the amount of fission products and actinides contained in an irradiated fuel, as a rule expressed in becquerels per gram initial heavy metal, or grams per tonne initial heavy metal (Bq/giHM, or g/tiHM). These quantities, and the associated isotopic spectra depend on a number of parameters, such as the nature of the fuel, and irradiation conditions (burnup...). Average inventories are computed, for a given point in time, by means of computation codes, whereas inventory distribution, depending as it does on irradiation conditions, and fuel thermics, requires use of characterization resources (electron microprobe...). 101–103, 113, 165, 166.

**Reactivity** (neutronic): a dimensionless quantity, used to evaluate small variations in the **multiplication factor  $k^*$**  around the critical value, and defined by the formula:  $\rho = (k - 1)/k$ . Its value being very small, it is as a rule expressed in percent millirhos (**pcm\***). In a reactor, there is zero reactivity when the reactor is **critical\***; reactivity is positive when it is **supercritical\***, and negative when it is **subcritical\***. 160, 161.

**Recycling**: the reuse, in reactors, of nuclear materials yielded by the **treatment\*** of spent fuel. 7–167

**RepU**: acronym for “reprocessed uranium”: uranium yielded by spent fuel treatment operations. 35, 71.

**Rod**: a small-diameter tube, closed at both ends, used as a component of a nuclear reactor core, holding **fissile\***, **fertile\***, or neutron-absorbent material. When it holds fissile material, the rod is a **fuel element\***. 37–40.

**SANEX**: Separation of Actinides by Extraction. 10, 69, 88, 89, 103, 109–113, 118–120, 124–126.

**Separation**: a chemical process, forming part of the **treatment\*** operations, whereby the various constituent elements of spent fuel are separated. The **PUREX\*** process partitions uranium, and plutonium; other, more advanced chemical processes (**DIAMEX\***, **SANEX\***, **GANEX\***) are being investigated, and developed for the purposes of separating actinides from lanthanides, or separating actinides one from another (see also **Partitioning\***). 7–167.

**SFR**: sodium-cooled fast reactor. 91, 92, 103, 141.

**Sievert** (Sv): a unit used to measure the absorption of radiation by the human body. 102.

**Sintering**: an operation involving the welding together of grains of a compacted metal or ceramic powder, by heating it to a temperature lower than the melting point of the material. 37, 139, 141, 143, 144, 145, 152.

**Spallation**: a nuclear reaction involving a target heavy nucleus, and a particle (most commonly a proton), accelerated to an energy of up to several hundred million electronvolts. By way of successive collisions with nucleons in the target nucleus, the incident particle ejects, among other particles, a large number of neutrons. A 1-billion-electronvolt (1-GeV) proton, directed at a lead target, may thus yield 25–30 neutrons. 163.

**Specific burnup** (or **burnup\***, or **burnup fraction\***): the total amount of energy yielded, per unit mass, in a nuclear fuel. This is generally expressed in megawatts-day per tonne (MWd/t). 36, 39–41, 47, 91–94, 99.

**Stripping** : see **back-extraction**.

**Subcritical**: a system is said to be subcritical when the number of **neutrons\*** released by **fission\*** is lower than the number of neutrons disappearing through absorption, and leakage. In that case, the number of fissions observed, over successive, equal time intervals, decreases. 48, 73, 137, 151, 159, 163.

**TALSPEAK**: Trivalent Actinide–Lanthanide Separation by Phosphorous reagent Extraction from Aqueous [K]complexes. 89, 109, 113.

**TBP**: tri-*n*-butyl phosphate (usually simply referred to as tributyl phosphate). This molecule is used as extractant\*, in the **PUREX\*** separation process. 7, 13, 21, 34, 35, 55–61, 67, 76–78, 83, 104–112.

**TODGA**: 110

**Transmutation**: the transformation, by means of a **neutron\***-induced nuclear reaction (capture, **fission\***), of one **isotope\*** into another. Transmutation is an option that would allow effecting the fission of certain **minor actinides\***, currently consigned to waste. 11, 90, 101–103, 151–165.

**Transuranium elements**: all elements having an atomic number higher than that of uranium. In reactors, this refers to the heavy nuclei yielded by uranium through **neutron\*** capture, or forms of **radioactive decay\*** other than **fission\*** – these falling into seven families of isotopes\*: uranium, neptunium, plutonium, americium, curium, berkelium, californium. 8, 10, 128, 149, 150, 159, 160.

**Treatment** (of spent fuel): an operation involving the separation, in spent fuel, of materials recoverable for value-added purposes from the remainder, this then being deemed to be waste, catered for through appropriate conditioning. 33, 7–167.

**UNGG**: a natural uranium-powered, graphite-moderated, gas-cooled (CO<sub>2</sub>) reactor line. 34, 36.

**UOX**: the standard **light-water reactor\*** fuel, consisting of uranium 235-enriched\* uranium oxide. 34, 7–167.

**Vitrification**: an operation involving the incorporation of nuclear waste materials into glass, to achieve a stable **conditioning\*** for them, in the form of packages suitable for **storage\***, or **disposal\***. 9, 35, 53, 75, 76, 79–81, 101, 104, 126, 153, 167.

**XANES**: X-ray absorption near edge structure (see **XAS\***). 16, 18.

**XAS**: X-ray absorption spectroscopy; this allows the measurement of variations in the X-ray absorption coefficient, in an energy domain extending several hundred electronvolts beyond the ionization threshold of a chemical element. Such analysis yields information as to the electronic characteristics (oxidation state) of the element being analyzed (**XANES\***), as of its atomic environment: nature, distance, and number of atoms located in the vicinity of the element analyzed (**EXAFS\***). 16, 18.

# Contents

Foreword	5
<b>Introduction</b>	
Actinide partitioning: a major building block for sustainable nuclear energy	7
<b>The physicochemical properties of actinides</b>	
Actinides: a 20th-century discovery	11
Radionuclides in nuclear fuels	13
Actinide aqua ions	15
Some oxidation–reduction properties of actinides	19
Major actinides (U, Pu)	19
Minor actinides (Np, Am, Cm)	21
“Heavy” actinides	22
Some complexation properties of actinide cations	23
The hydrolysis case	23
Complexation in aqueous solution: the general case	26
Nitrate ions	27
Peroxo ions	28
Oxalato ions	28
Conclusion, and prospects	31
<b>The PUREX process</b>	
Overview of treatment processes	33
Historical background	33
The French background	34
Principles and purposes of the PUREX process	34
Operation of the PUREX process	35
The PUREX process: an operational balance sheet	36
Prospects for future evolution	36
Some characteristics of nuclear fuels, relevant for their treatment	37
Fresh fuels	37
Irradiated fuels	39
The PUREX treatment process: technical targets, and specific constraints	43
Endproduct specifications	43
Restrictions on discharges into the environment	43
Waste conditioning	44
Specific constraints	44
The PUREX process: head-end operations	45
Fuel decladding	45
Fuel dissolution	46
Dissolver technology	47
Dissolution solution stability	50
Treatment of dissolution off-gases	52
Clarification of dissolution solutions	53
The PUREX process: separation and purification operations	55
Extraction cycles	55
Extraction equipment technology	60
Modeling the PUREX process. The PAREX code	66

<b>Endproduct fabrication with the PUREX process</b>	<b>71</b>
Uranium conversion routes to the oxide form	71
Plutonium conversion routes to the oxide form	71
Production of PuO <sub>2</sub> by oxalic conversion in the Areva treatment plants at La Hague	72
<b>Liquid effluent management, and treatment</b>	<b>75</b>
Aqueous liquid effluents	75
Organic liquid effluents	76
<b>Solid waste from the PUREX process</b>	<b>79</b>
Classification of PUREX waste	79
Process waste, and technological waste treatment, and conditioning	79
Bringing down volumes, and activity (PURETEX)	81
<b>Towards group management of uranium and plutonium: the COEX™ process</b>	<b>83</b>
Coextraction of uranium and plutonium: the COEX™ process	83
Coconversion of uranium and plutonium with the COEX™ process	84

## The cycles of the future

<b>Technological options for treatment, and recycling</b>	<b>87</b>
<b>Generation-IV reactor fuels</b>	<b>91</b>
Choice of fissile material	91
Sodium-cooled fast reactor fuel	92
Gas-cooled fast reactor fuel	92
Very-high-temperature reactor (VHTR) fuel	94
Characteristics of fuels incorporating minor actinides	95
<b>Treatment of advanced fuels: head-end processes</b>	<b>97</b>
Breakup of metal-clad fuels	97
Breakup of ceramic composite-clad fuels	98
Dissolution of advanced fuels	99
<b>Hydrometallurgical processes for the fuel cycles of the future</b>	<b>101</b>
Introduction	101
Neptunium partitioning	104
Technetium separation	107
Strategies for the partitioning of minor actinides Am and Cm by solvent extraction	108
Towards relations between structures, and extraction properties	114
Partitioning processes for the minor actinides Np, Am, Cm	118
Cesium separation processes	126
Group partitioning of actinides	128
<b>Actinide conversion</b>	<b>135</b>
The new challenges set by actinide coconversion	135
Development of coconversion processes for the fuel cycles of the future	137
Towards development of actinide coconversion processes at the industrial scale	139
Fuel refabrication	141
<b>Refabrication: challenges, and constraints</b>	<b>141</b>
Specific characteristics of fuels incorporating minor actinides	141
Special characteristics of carbide fuel	142
Advances in R&D studies	143
Prospects	145
<b>Pyrometallurgical processes</b>	<b>147</b>
Current applications, and limitations of pyrochemistry	147
Potentials for the nuclear energy technologies of the future	148
The pyrochemical processes being investigated	148

## Is the transmutation of separated radionuclides feasible?

Radionuclide management strategies	151
How is transmutation to be carried out?	155
The physical basis of transmutation	155
Neutronic characteristics of actinides	156
Overall efficiency of in-reactor transmutation	158
The neutron balance	159
The impact of actinide transmutation on core physics	160
The various minor actinide recycling modes	161
Impact of actinide transmutation on the fuel cycle	161
Should long-lived fission products undergo transmutation?	162
Irradiation experiments to support development of transmutation concepts	163
Partitioning and transmutation scenarios	165

## Conclusion

General conclusion	167
Glossary–Index	169

---

Contributors to the present volume:

Michaël Lecomte (Topic Editor)  
Éric Abonneau,  
Pascal Baron,  
Claude Berthon,  
Laurence Berthon,  
Alain Béziat,  
Isabelle Bisel,  
Lucie Bonin,  
Émilie Bossé,  
Bernard Boullis,  
Jean-Charles Broudic,  
Marie-Christine Charbonnel,  
Nathalie Chauvin,  
Christophe Den Auwer,  
Binh Dinh,  
Jean Duhamet,  
Jean-Michel Esclaine,  
Stéphane Grandjean,  
Philippe Guilbaud,  
Denis Guillaneux,  
Dominique Guillaumont,  
Clément Hill,  
Jérôme Lacquement,  
Michel Masson,  
Manuel Miguiritchian,  
Philippe Moisy,  
Michel Pelletier,  
Alain Ravenet,  
Christine Rostaing,  
Vincent Royet,  
Alexandre Ruas,  
Éric Simoni,  
Christian Sorel,  
Aimé Vaudano,  
Laurent Venault,  
Dominique Warin,  
Alain Zaetta,

... together, of course, with all the members of the DEN  
Monographs Editorial Committee:

Bernard Bonin (Editor in chief), Alain Vallée (CEA Saclay  
Center), Martine Dozol (CEA Cadarache Center),  
Michaël Lecomte (CEA Valrho Center),  
Bernard Bouquin (Communications Division), Michel Beauvy,  
Georges Berthoud, Mireille Defranceschi, Gérard Ducros,  
Yannick Guérin, Yves Limoge, Charles Madic, Philippe Moisy,  
Gérard Santarini, Jean-Marie Seiler, Pierre Sollogoub,  
Étienne Vernaz.