

Commissariat à l'énergie atomique et aux énergies alternatives

e-den

A Nuclear Energy Division
Monograph

Research Nuclear Reactors

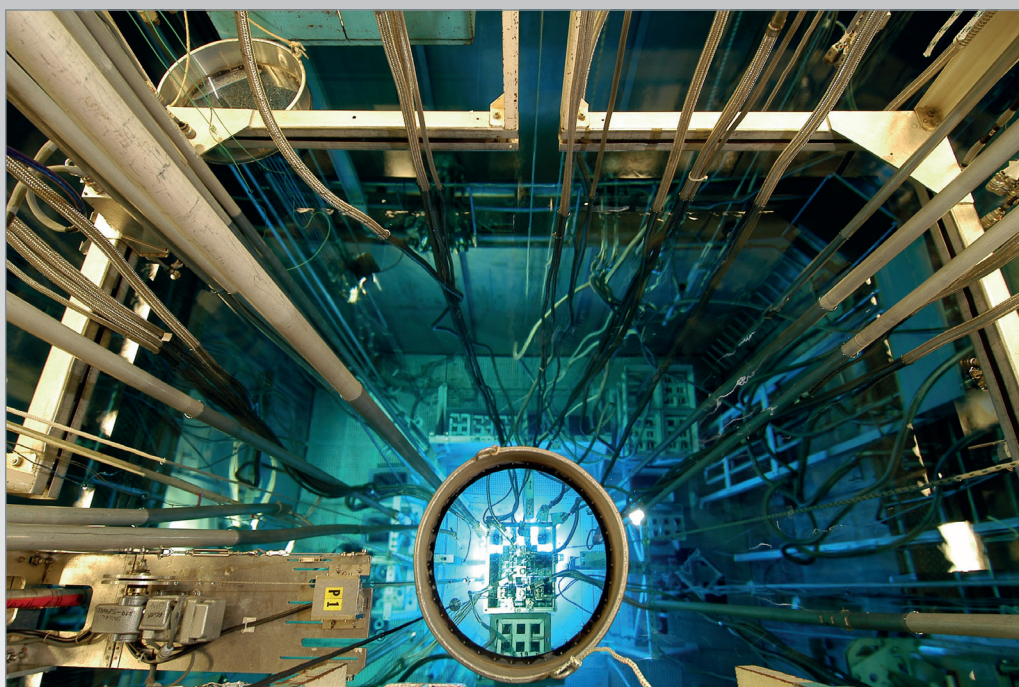

EDITIONS
LE MONITEUR



énergie atomique • énergies alternatives

DEN Monographs

A Nuclear Energy Division Monograph
Commissariat à l'énergie atomique et aux énergies alternatives,
91191 Gif-sur-Yvette Cedex (France)
Tel: +33 (0)1 64 50 10 00

Scientific Committee

Michel Beauvy, Georges Berthoud, Gérard Ducros, Damien Féron,
Yannick Guérin, Christian Latgé, Yves Limoge, Gérard Santarini,
Jean-Marie Seiler, Etienne Vernaz, Research Directors.

Topic Editor: André Chabre.

Contributors to this Monograph:

Alain Alberman, Michel Auclair, Nicolas Authier, Daniel Beretz,
Gilles Bignan, Jean-Yves Blanc, Bernard Bonin, Jean-Christophe
Bosq, Xavier Bravo, André Chabre (Topic Editor), Pascal Chaix,
Jean-Marc Costantini, Gérard Ducros, Philippe Durande-Ayme,
Jérôme Estrade, Philippe Fougeras, Danielle Gallo, Christian
Gonnier, Lionel Gosmain, Daniel Iracane, Philippe Jucker, Jean-
Christophe Klein, Thierry Lambert, Patrick Lemoine, Richard
Lenain, Stéphane Loubière, Clarisse Mariet, Loïck Martin-Deidier,
Frédéric Mellier, Alain Menelle, Sandrine Miro, Emmanuelle Muller,
Joseph Safieh, Henri Safa, Stéphanie Sorieul, Patrick Trocellier,
Caroline Verdeau, Jean-François Villard, Alain Zaetta.

Editorial Director: Christophe Béhar.

Editorial Board: Bernard Bonin (Editor in chief),
Marie-José Lovérini, Martine Dozol, Michaël Lecomte,
Alain Forestier.

Administrator: Fanny Bazile.

Editor: Jean-François Parisot.

Graphic concept: Pierre Finot.

Translation: Catherine Andrieux.

Correspondence: all correspondence should be addressed
to the Editor or to CEA/DEN Direction scientifique, CEA Saclay
91191 Gif-sur-Yvette Cedex (France)
Tel: +33 (0)1 69 08 16 75

© CEA Saclay and Groupe Moniteur (Éditions du Moniteur),
Paris, 2012

ISBN 978-2-281-11508-6
ISSN pending

The information contained in this document may be freely
reproduced, subject to agreement by the Editorial Board
and due acknowledgement of the source.

Front cover: top view of the OSIRIS reactor pool located
at CEA/Saclay site and dedicated to investigation of materials
under irradiation.

Commissariat à l'énergie atomique et aux énergies alternatives

e-den

A Nuclear Energy Division
Monograph

Research Nuclear Reactors

EDITIONS
LE MONITEUR



energie atomique • energies alternatives

Foreword

After a dazzling start in the 1950's when, for many, it stood as the hope of an inexhaustible, economically competitive energy source, nuclear energy experienced in the 1980's and 1990's a rejection by majority public opinion in several Western countries, which suddenly brought its development to a halt.

Although the 1973 and 1979 oil crises marked the launch of massive equipment programs in a few countries heavily penalized by oil imports, in particular France and Japan, they were paradoxically followed by a gap in nuclear investments, first, in the United States, and then in Western Europe. However, repeated oil market tensions and emerging concerns over the possible depletion of natural resources, as well as expectable effects on climate and the environment due to their large-scale burning should have, by contrast, enhanced such investments.

There are surely many reasons for this pause, which can in part be explained by the accidents at Three Mile Island in 1979, and Chernobyl in 1986, deeply impacting public opinion. Fukushima recent accident legitimately raises again the same questions, although the context is quite different. The pending issue is not so much whether reactors are technically able to withstand the most improbable events: Fukushima focuses renewed attention, indeed, on how to train operators and actors of the decisional process in charge of tackling a severe dysfunction of engineered safety systems in the case of equipment failure.

In France, whereas the siting of nuclear power plants had never - except for one case - aroused a true debate in the population, a negative attitude emerged in the late 1980's concerning the nuclear waste issue. Given the growing difficulties of the French national agency for nuclear waste management (ANDRA) in its search for an underground laboratory site, the Government of the time decided to suspend work, set a one-year moratorium, and submitted the issue to the French parliamentary office for evaluation of scientific and technological options (OPECST).

By adopting most of the OPECST's recommendations, in particular its definition of a diversified research program, and also the basis for a democratic debate with the populations concerned, the French Act of December 30, 1991 on nuclear waste management thus greatly contributed to calm the debate. Following a fifteen-year period, in which various options for long-term radioactive waste management were investigated, the Act of June 28, 2006 made it possible to set out the basic framework for this management, to be recognized as a necessity from now on.

In addition, the starting century is marked by collective awareness that our generation's energy needs cannot be met without concern for the environment, and without preserving future generations' right to satisfy these same needs. This is the concept of sustainable development which our society will inevitably face, indeed.

Today, it goes unquestioned that global warming due to increasing greenhouse gas emissions is a human-caused problem. Only the extent and consequences of of this warming are still debated. Industrialized countries, who are for the most part the origin of the current situation, should hold a particular responsibility, which should induce them to voluntarily reduce emissions of these gases. By its very nature, nuclear energy is not concerned by

this type of emissions, while being able to produce a relatively abundant, reliable, and economically competitive energy source. Quite naturally, it is therefore expected to be the predominant energy source.

Even if the worldwide situation is still contrasted, more especially in Europe, several countries (China, South Korea, Finland, India, South Africa, Poland, the United Arab Emirates...) have already decided to make huge investments in developing this energy, and do keep this option after Fukushima accident. Others are very close to taking this step, in particular Great Britain and the United States, who seem to be determined to launch programs for the construction of new nuclear power plants by the end of the decade, picking up a process that had been on hold for thirty years.

Following France's national energy debate that took place in the first half of 2003, the Strategic Orientation Act on energy passed in June 2005 established the decision to build an EPR demonstrator reactor, to pave the way for the replacement of currently operating power plants.

A number of signs thus lead us to believe that a worldwide revival of nuclear energy is taking place. Nevertheless, the future of nuclear energy in our country, as in many others, will largely depend on its capacity to properly address the following two concerns:

- The first concern has to do with its social acceptability, for it is crucial that nuclear energy be deployed under optimum safety and security conditions, generating a minimum amount of ultimate waste, and the latter be fully controlled with regard to its possible impact on health and the environment. The shock caused by Fukushima accident can but enhance this safety requirement as an absolute priority.

- The second concern relates to the availability of its resources: it is important to guarantee a long-term supply of fuel, by preparing to resort to systems which are more economical in terms of natural fissile materials and, above all, less dependent on market fluctuations.

These topics are a key part of the CEA Nuclear Energy Division's work. Indeed, this Division is a major player in the research work aimed at supporting the nuclear industry in improving reactor safety and competitiveness, providing the Public Authorities with the elements necessary to make choices on long-term nuclear waste management, and, finally, developing the nuclear systems of the future. These systems, mainly fast neutron reactors, exhibit highly promising improvements with regard to waste management and raw materials use.

As a fervent partisan of the broadest possible dissemination of scientific and technical knowledge, it seems to me of the utmost importance that this research work, which calls upon a wide range of scientific disciplines often ranking among the best in the world, should be presented and explained to all those who would like to form their own opinion on nuclear energy. This is the reason why I welcome the publication of these DEN Monographs with deep satisfaction, indeed. No doubt that close reading of these works will afford an invaluable source of information to the, I hope, many readers.

I would like to thank all the researchers and engineers who, by contributing to this project, willingly shared their experience and knowledge.

*Bernard BIGOT,
CEA Chairman*

Research Reactors, their Use and History

Research reactors have paved the way for, preceded, and accompanied the development of nuclear power.

On December 2, 1942 a scientists' team conducted by Enrico Fermi succeeded in initiating the first divergent chain reaction and, so, in operating the first experimental atomic pile in the basement of a Chicago ground. It was thus evidenced that atomic fission could be induced and controlled.

1951 was the year when nuclear energy generated electric power for the very first time. The event took place in the United States, with the commissioning of the EBR-1 reactor, able to create enough power to light up one thousand 100-watt bulbs.

Since then, all proceeded quickly for nuclear energy development, and the indispensable role of research reactors in this step appeared quite soon with the achievement of increasingly powerful, specialized, and high-performance reactors in response to needs. Thus, from the 1945's to date, more than 600 research reactors or critical assemblies were built in the world, with powers ranging approximately from zero to several hundred thermal megawatts, along with a high diversity in design, use and operating mode.

What are Research Reactors Used for?

How to define them?

Research reactors are nuclear facilities in which a **chain reaction*** is generated and sustained so as to get a **neutron*** flux to be used for experiments. The energy produced by fission reactions is not recovered generally.

The performances of a research reactor are characterized as follows:

- The **neutron spectrum*** generated, i.e. the energy distribution of these neutrons which, depending on the **core*** configuration selected, will be representative of a low-energy neutron spectrum, the so-called “thermal” neutron spectrum (energy < 0.625 eV), or of a high-energy neutron spectrum (energy > ~0.9 MeV), which is then named a “fast” neutron spectrum.
- The **neutron flux*** produced (from 10^5 neutrons/cm².s to more than 10^{15} neutrons/cm².s).

The design of each research reactor is achieved depending on its future uses, and the neutron spectrum generated as well as its intensity are tailored accordingly, as will be seen further. As a matter of fact, the most specialized research reactors display very specific flux characteristics, whereas multipurpose research reactors intended for several types of activities are designed to generate both fast neutron and thermal, or intermediate, neutron spectra with, of course, less “cutting-edge” features.

Research reactors and nuclear power: critical mockups, material test reactors, safety test reactors, training reactors, prototypes

Neutrons generated in research reactors are first used to achieve experiments relating to the development of nuclear power reactors, for both the understanding of the phenomena involved, and the validation and qualification of the solutions retained.

Three main categories of research reactors have to be considered in relation to this issue:

- Reactors designed to validate neutronics calculations of power reactors, also called “critical mockups”;
- Reactors designed to investigate and qualify the behavior of structural materials and fuels under irradiation, also called Materials Test Reactors (MTRs);
- Reactors designed to investigate accident situations, also called “safety test reactors”.

Critical mockups

No major development of nuclear concepts and techniques can take place, regarding the development of power reactors as well as of the cycle of associated fuels, without both neutronics studies and validation tests for these calculations. For, even if neutronics is based on equations fully representative of phenomena, an experimental adjustment proves to be necessary as soon as the aim is to progress, validate, and quantify accurately, due to the amplitude of the energy ranges involved, the multiplicity of the materials used and their characteristics, and the complex geometries of fuel assemblies.

Critical mockups are the tools suitable for such experiments. They are so called because, first, they are more or less used to experiment “mockups”, also called “lattices”, fully or partially representative of the core configurations to be studied, and, secondly, because no power or significant flux is required for that, due to the linearity of neutronic phenomena. It is sufficient to operate them in a “just **critical***” state for physical and neutronic quantities to be measured. So their power ranges from 100 watts or so to a few kilowatts, and neutron flux intensity is lower than 10^{12} n/cm².s for most of them.

The design of these critical mockups is most often simple and highly adaptable. Thus, from a mechanical viewpoint, water-cooled critical mockups chiefly consist of an open tank vessel which contains the fuel lattice to be experimented, and, if need be, additional fuel elements (called the *driver core*) to reach the critical state, and the neutron absorber (control) rods. There are very few auxiliary circuits, for there is no power to be removed.

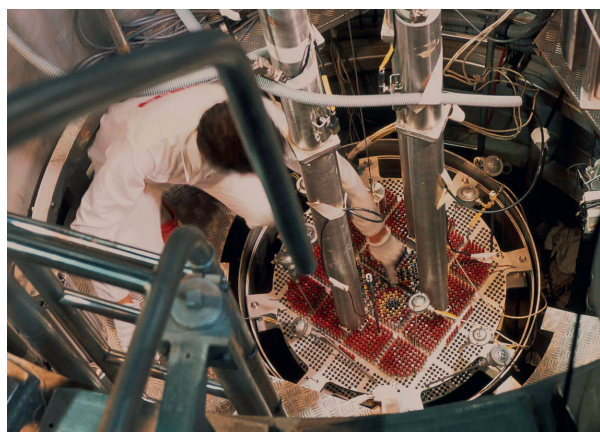

Fig. 1. Top view of the ÉOLE critical mockup, under preparation prior to achieving qualification tests of a boiling water reactor core.

In contrast, lattices representative of the core configurations to be investigated may be very complex. They are highly instrumented with various devices used to measure flux and temperature, so that the lattices under consideration may be fully characterized.

Figure 1 hereafter, which displays the vessel of the ÉOLE critical mockup (top view) as being prepared for an experiment, well shows the simplicity of the mockup, the complexity of the core with the fuel lattice to be studied (the four central elements), as well as the fuel elements of the driver core all around, the absorber (control) rods, and the instrumentation being set in place.

So, even if operating a critical mockup is simple, the making of experimental cores, their instrumentation, the analysis and use of results require highly skilled staff, performing nuclear instrumentation supports, and constant coupling with neutronics calculation tools.

Materials test reactors

These reactors have to play a first-rank role, that is qualifying the main components of power reactors - *i.e.* materials and fuels, sensors, etc. – under irradiation conditions representative of those occurring in these reactors.

So they have to display high-performing features with respect to flux level and operating capability, for one of their main interests is to allow highly instrumented experiments to be achieved, under continuous monitoring, up to limits that could not be tolerated in a power reactor. These high flux levels, exceeding those to be met in nuclear power plants, allow thorough studies of materials and components ageing under irradiation to be performed within sufficient time intervals for the best materials and provisions to be determined at the design step for these reactors.

Accordingly, powers to be met in materials test reactors range from a few dozen MW to 100/200 MWth, which means a neutron flux of about 10^{13} to 10^{15} n.cm⁻².s⁻¹.

Nowadays, most of research reactors of this type are water-cooled reactors, with two alternatives:

- The so-called “pool reactors (or piles)”, in which the reactor block is immersed in a water pool and connected with the latter. Owing to the low pressurization of the reactor coolant system, this type of disposition limits the power density of the reactor, but, as a counterpart, ensures a very high accessibility for the materials and fuels to be experimented;
- Tank reactors, which allow higher power density and flux levels to be reached thanks to the possible pressurization of the reactor coolant system (5-20 bars), but which make it more difficult to access to experiment locations in the core (fig. 2).

The other main interest of these irradiation reactors lies in that materials and fuels to be experimented can be put under conditions representative of those encountered in power reactors; in addition to neutron flux and according to experiment complexity, these conditions may involve temperature, mechanical stresses, such as pressure, the physicochemical conditions of the environment, etc.

Table 1

Comparison of flux and materials damage characteristics for power reactors and materials test reactors				
Reactor	Thermal neutron flux n/cm ² .s	Fast neutron flux n/cm ² .s	Thermal flux in the core kW/liter	dpa/year*
Power reactors PWR - BWR type	9.10^{13}	$1.3.10^{14}$	80	2 - 3
OSIRIS	$2.7.10^{14}$	$2.7.10^{14}$	320 max.	6
JHR	$5.5.10^{14}$	$5.5.10^{14}$	600 max.	16

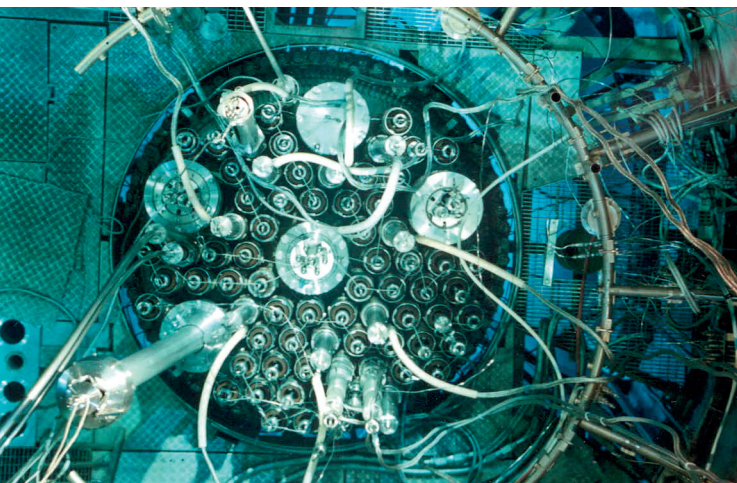

Fig. 2. An example of tank-type materials test reactor: SCK/CEN's BR-2 reactor (Belgium).

In order to get such representative conditions, materials and fuels are placed in appropriate devices designed so as to be positioned in the reactor core or on its peripheral part according to the flux of interest and the type of experiment considered. These devices also hold the instrumentation that allows measurements required for real-time follow-up of the irradiation. See the chapter on “Instrumentation for Research Reactors” (pp. 41-44), which details this specifically designed instrumentation.

Last but not least, these devices are designed so that their use may not entail any risk for the reactor, under any circumstance, or any radioactive release.

They roughly belong to two types:

- Capsules, in which the coolant (gas, NaK^* ...) is static, as heat exchange for cooling is performed by conduction to the water of the reactor coolant system;
- (Water, gas, sodium) loops, more complex, but allowing for higher representativeness, which are endowed with their own pressurization and temperature control system; these systems are most often placed in shielded cells on the periphery of the reactor, and are connected to the in-pile device itself by flexible pipings.

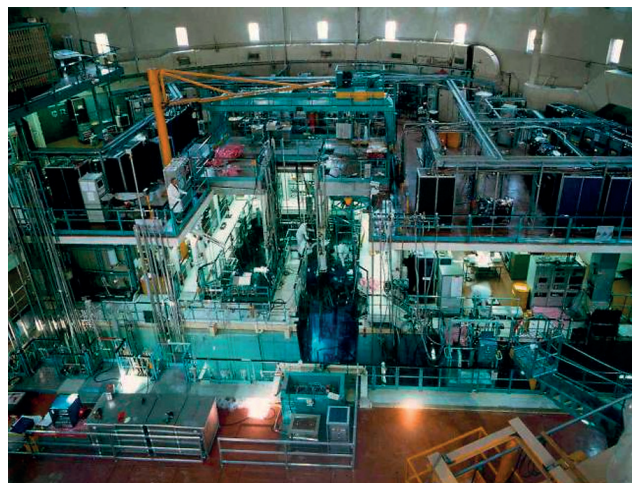

Fig. 3. The OSIRIS reactor –The experimental hall: overall view showing the pool containing the reactor, and part of the facilities that allow the various experimental devices put in the reactor to be operated and controlled.

Figure 3 shows part of the facilities associated with the experimental devices and with their instrumentation and control system around the OSIRIS reactor.

Materials test reactors operate by cycles of 20-30 days of power operation, during which a number of irradiation experiments are loaded in parallel in the reactor. Intercycle periods of a few days are used to load and unload experimental devices according to needs. Some specimens under irradiation can then be subjected to nondestructive examinations, such as visual, dimensional, gamma spectrometry and neutron radiography examinations, that make it possible to follow their evolution under irradiation.

After irradiation, specimens often undergo destructive examinations in hot cells so that the effects of this irradiation may be fully characterized (see below the chapter on “Laboratories Associated with Research Reactors”, pp. 87-93).

Safety test reactors

Risk control* is always a prime requirement in the use of nuclear energy. So, even if all is done to reduce the occurrence of incident and, above all, severe accident situations inducing a degradation of fuel elements, or even their more or less significant destruction, it is important to know how they take place, and evaluate their consequences.

This is why, practically from the very early days of research reactors, they have been increasingly used to perform tests representative of such situations, basing first on special devices and rigs, and then on reactors specifically designed to achieve these tests.

Two types of severe accidents require special tests performed with dedicated research reactors:

- Reactivity insertion accidents. This type of accident is likely to affect all reactor types, in any of their operational steps: whether in power operation mode or not, including the stage of fuel element loading. Special attention has to be paid to it in the case of research reactors and critical mockups, due to high accessibility of their core and frequent reshuffles of the latter. The corresponding reference (design basis) accident for power reactors is the ejection of a control rod from a reactor under operation. It is characterized by a very strong, very short impulse of reactivity leading to a power excursion of several dozen thousands of MW within a few milliseconds;
- Loss of flow in the reactor coolant system, and loss of coolant. The accident effects are all the more serious as the reactor operates at high power. It then results in a significant release of radionuclides, and their dissemination across the reactor containment barriers depending on their being affected or not by the accident.

Reactors used for safety tests have been of quite a variety of types in the course of nuclear history: air-cooled, water-cooled, and liquid-fuelled reactors. Their specific features are the following:

- These reactors have to be able to reproduce complete sequences of the accident in perfectly safe conditions;
- They use a broad range of specific instrumentation;
- Performing complex experiments requires a long period of design and preparation. The safety test itself is achieved in a short period of time, to be followed by a long period of analysis and interpretation;
- Programs are most often conducted within an international framework likely to foster safety knowledge sharing.

The fourth section of this Monograph (p. 113-118) details the facilities designed to investigate representative accident situations as well as the types of results and lessons to be learned from it.

Reactors dedicated to teaching in nuclear engineering and training

All research reactors can conduct activities of this type, but of course, for reasons of easy access and availability, reactor types dedicated to training have been set up. The latter exhibit the following features:

- Low powers ranging from a few hundred watts to a few hundred kW;
- Flexibility and simple use, as well as easy access;
- The possibility to display the neutron behavior of the reactor core;
- The presence of training teams and associated didactical tools.

Research reactors for training and teaching

Since the early years of nuclear energy, research reactors have been used for teaching and vocational training. They give access to a concrete approach of reactor physics, and are an intrinsic part of pedagogical curricula in initial vocational education and training schools, as well as of nuclear operator and safety authority training courses.

The reactors used for this training are either reactors specially dedicated to training (ISIS reactor at CEA/Saclay), or reactors with their own experimental programs which provide training periods (AZUR and MINERVE at CEA/Cadarache).

Pedagogical benefit of research reactors

As part of the pedagogical approach, achieving practical work allows real physical phenomena to be known (evolution of neutron density), and correlated with the evolutions of the reactor's main physical parameters (reactivity, core temperature...).

In particular, practical work allows for the following processes:

- Displaying the various components of a reactor, and understanding the constraints related to its design and safe operation;
- Monitoring the safety of core loading operations by following up neutron density;
- Determining startup conditions in fully safe conditions during the subcritical approach (control rod motion, water level, boron content);
- Highlighting the influence of any core alteration on neutron density: control rod motion, experimental device motion, temperature change);

- Determining the reactor's characteristics: control rod efficiency plot, temperature coefficient, power supply...;
- Taking part in decisions relating to control systems actuation (rods, water flow...) under safe conditions;
- Getting a first practical experiment in reactor fine control under the supervision of the operating team;
- Studying the operation of neutron measuring channels for chain reaction monitoring;
- Taking radiation protection measures in the facility by using various devices (radiation monitors, multipurpose radiation meters, pellet activation...).

Training sessions

As part of initial training, the spectrum of training sessions based on practical work has extended in the latest years.

Practical work sessions have been conducted for students attending the INSTN¹ Atomic Engineering course, students in top French engineering schools (École Centrale Paris, ENSAM, École Polytechnique, ...), as well as students attending Master courses in physics in Paris VII and Paris XI Universities.

As part of continuing education, research reactors are used for:

- The training of research reactor operators, which includes an initiation to reactor control (ISIS reactor);
- The training of control teams for nuclear steam supply systems (AZUR control);
- Periodic sessions of further education for operating staff of research reactors;
- Staff training for the various actors of nuclear organizations (ASN², CEA, IRSN...) and companies (AREVA, EDF...), with 1-8 week training sessions, dealing with reactor principles and operation, neutronics, and the operation of neutron counting channels;
- International courses for all nuclear actors, dealing with reactor principle, operation and neutronics.

Given needs in staff turnover, the resurgence or start of nuclear power in some countries, as well as research on new reactors, an increase of demand in initial training and continuing education has been observed for several years in France and in the world.

1. INSTN: a French acronym for *Institut National des Sciences et Techniques Nucléaires*.
 2. ASN: a French acronym for *Autorité de Sûreté Nucléaire*, the French nuclear safety Authority.

Training reactors

ISIS reactor

The ISIS reactor located at CEA/Saclay is a pool reactor with a 700-kW thermal power (fig. 4). This is the neutron mockup of the OSIRIS reactor (70 MW). The ISIS core, placed at the bottom of a pool 7 meters deep, uses a 19.75 %-enriched U_3Si_2 fuel.

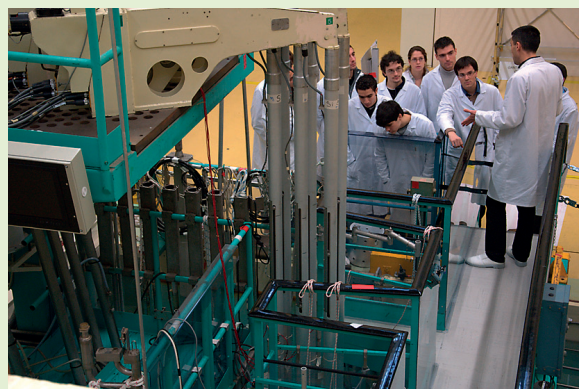

Fig. 4. Student group under training in the ISIS reactor hall.

A major upgrading of the ISIS reactor took place between 2004 and 2006 in order to tailor this reactor to training. In particular, a monitoring software allows the evolution of relevant parameters to be followed on a video device for every handling performed in the reactor (fig. 5).

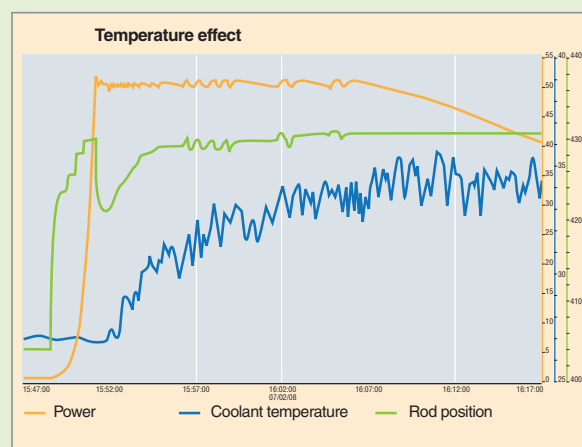

Fig. 5. A pedagogical illustration of the temperature effect in the ISIS reactor during a power transient: ISIS monitoring screen for following up reactor power, regulating rod position and coolant temperature during a stabilized 500 W- 50 kW ramp, before automatic control is shut down.

Since March 2007 about a hundred of practical work sessions have been conducted on the ISIS reactor every year.

AZUR reactor

The AZUR reactor located at CEA/Cadarache is operated by AREVA-TA. Since its first divergence on April 9 1962, the AZUR reactor has experimented all the cores of reactors dedicated to naval nuclear propulsion. It is also used for training.

The reactor underwent an upgrading in 2001-2002 in order to extend its operation beyond 2015; One of the effects of that upgrading was an adaptation of the control board and a back-fitting of the control room in order to make information display easier. Training sessions are performed with a specially dedicated core. Sixty 3-hour practical work sessions are held every year.

MINERVE reactor

The MINERVE reactor described p. 61-64 is chiefly used for neutronic studies of thermal and fast neutron reactors. It is also an appropriate tool, indeed, to meet training needs, due to the flexibility of use of this very low-power reactor. Fifteen 7-hour practical work sessions are conducted on MINERVE every year (fig. 6).

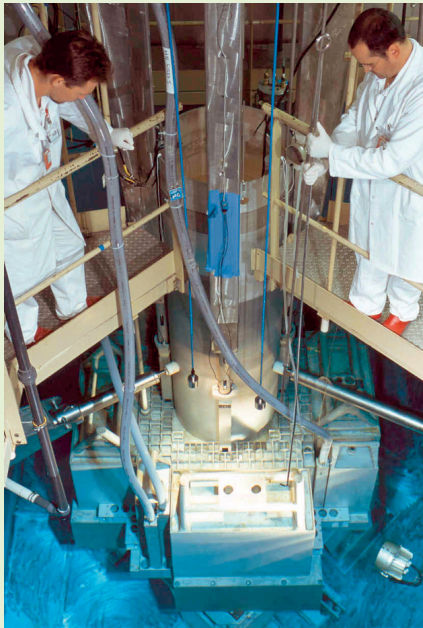

Fig. 6. MINERVE reactor core.

One may wonder whether using reactors for training is still justified due to simulation progress. Yet, the little thrill felt by the students and future operators who attend the divergence of a real reactor, does have a unique pedagogical value. This is why, after using research reactors for half a century, the CEA sees that these tools of high value for nuclear power actors' training have an extended lifetime.

Test reactors and prototypes

In some way, these reactors are at the other end of the experimental reactor scale. They include the following:

- Reactors designed to validate a reactor type concept, called “demonstrators”;
- “Prototype” reactors designed to validate an industrial nuclear solution on a representative scale, and test its capabilities. The power of these prototypes has to be sufficient to validate the feasibility of the industrial techniques being implemented; it is most often of several hundreds of MWth;
- Reactors designed for qualification tests in a given reactor type. Qualification of full-scale components, fuel, and operating mode;

As an illustration, the inset on “The RES, a tool for major naval nuclear propulsion programs” displays the reactor of this last type which is dedicated to nuclear propulsion in France.



The RES, a tool for major naval nuclear propulsion programs

In order to maintain its capability to control naval nuclear propulsion, France needs its own land-based test facility.

Since 1964 such a function has been ensured by the PAT (*Prototype À Terre*: onland prototype) reactor, followed in 1975 by the CAP (*Chaufferie Avancée Prototype*: Prototype Advanced NSSS), which was finally turned into an RNG (*Réacteur de Nouvelle Génération*: new-generation reactor) in 1989. The RES (*Réacteur d'Essais*: test reactor) (fig. 7) is designed to succeed the RNG which was shutdown in late 2005.

Launched in 1995, the program is steered by the Nuclear Propulsion Unit of the CEA Military Applications Division. Its 3 major goals are as follows:

- Providing support for operation of nuclear steam supply systems (NSSS) for naval propulsion;
- Qualifying the nuclear fuels and cores of these NSSS and validating their computer codes;
- Developing and qualifying technological innovations, especially for future nuclear-powered attack submarines in the *Barracuda* program.



Fig. 7. Overview of the test reactor RES (*Réacteur d'Essais*) designed to study naval propulsion.

The RES facility, under construction at the CEA/Cadarache Center, will mainly consist of:

- **A test reactor** for developing nuclear steam supply systems (NSSS) for naval nuclear propulsion;
- **A fuel storage and examination pool** designed to house irradiated fuels from the French Navy's vessels, CEA's research reactors and, in the future, the RES itself.

The project is being run as part of a joint initiative by the CEA's Military Applications Division, responsible for project ownership, under the supervision of the French Joint Armed Forces-CEA Committee (*Comité mixte Armées-CEA*). Technicatome (AREVA TA) is the prime contractor. About a hundred of French national and regional companies, major companies and small-and-medium sized businesses, are involved in its construction, including AREVA TA (for the supply of equipment used on ships), and DCN (for the fabrication of the main reactor and containment components).

The program was launched in 1995 with a view to commissioning of the pool in 2005 and divergence of the reactor in 2013.

The RES program financing is mainly provided by the Defense Ministry. The CEA's Nuclear Energy Division, which will use part of the irradiated fuel storage pool, also takes part in the financing of this facility.

RES missions

The RES is an upgraded version of the K-15 type nuclear steam supply systems fitted to nuclear-powered ballistic missile launchers such as *Le Triomphant*, and the nuclear-powered aircraft carrier *Charles de Gaulle*, and to be fitted to future *Barracuda* nuclear-powered attack submarines. Its objectives are as follows:

Support for operation of the currently operating NSSS fleet

The reactor will reproduce the operation of nuclear steam supply systems, trying equipment under higher fatigue strength conditions than those really experienced on NSSSs. It will thus contribute to improve their operational availability, and demonstrate their safety.

Qualification of the fuel and cores of current and future nuclear steam supply systems

The thermomechanical qualification of fuels and the validation of codes simulating core behavior under irradiation are essential to optimize and improve NSSS performance while ensuring their safe operation.

Development and qualification of innovative technological concepts, especially for *Barracuda*

The RES is the platform on which *Barracuda* required performances are to be met, and its innovations are to be qualified, especially for the following items:

- Core performances (burn-up, lifetime...);
- The architecture of the NSSS unit (supporting structures, radiation protection by fixed and mobile pools);
- Instrumentation and control and man-machine interface.

Launched in 2001, the *Barracuda* program, jointly steered by the DGA (*Direction générale des armées*: General Directorate for Armies) and the CEA, aims at replacing the 6 ships of the *Améthyste* class currently at sea. The propulsion mode will be a hybrid electric/steam turbine system powered by an NSSS.

The test reactor was designed on the basis of a compact K15-type NSSS.

Most of the innovation lies in its instrumentation, which has been enhanced in order to take into account the increased needs for fuel and core qualification. Moreover, its design is modular to make it possible to qualify innovative technological concepts.

RES instrumentation

In order to ensure the validation of neutronics and radiation protection computer codes, and improve the simulation of core behavior under evolution, the RES is endowed with additional instrumentation systems: in-pile (*in core*) instrumentation and in-pool instrumentation (gamma spectrometry bench).

In the reactor, the *in-core* instrumentation allows for real-time mapping of neutron flux all along the irradiation process, using highly innovative probes. The *in core* instrumentation will encompass a broad range of neutron fluxes with a unique linearity. Yet, it provides a relative measure, hence the addition of a gamma-spectrometry bench located in the pool. The experimentation of the RES first core, named Hippocampe experiment, will allow for computer codes qualification, full-scale validation of the *Barracuda* program cores, full qualification of the nuclear fuel drawn from this RES core, and qualification of materials for the future.

Progress of the construction site

The construction site accounted for:

- Over 2 million working hours;
- About 20,000 m³ of reinforced concrete and over 4,000 t of reinforced bars;
- A few 450 km of electric cables and 40 km of piping;
- The major stages of the RES reactor construction have been reached:
- In 2005: the emplacement in the reactor containment building of the 800 t containment, and the emplacement of the 430 t precast slab, which covers the reactor building (fig. 8);
- In 2007: the emplacement of the reactor vessel in the reactor pit;
- In 2009: the first energization of the RES power plant;
- In 2010: the steam generator mounting and the first startup tests of the facility.



Fig. 8. The construction site of the test reactor RES (*Réacteur d'Essais*), with the emplacement of the metallic containment.

Spent fuel storage pool

As an indispensable component of reactor operation, the irradiated fuel storage pool completes the spent fuel storage device used in naval nuclear propulsion (pools of Île longue, Toulon and Cherbourg harbors). It will also house spent fuel elements of CEA research reactors.

The fuel storage and examination pool is equipped with a utility canal, a transfer canal and two channels designed to house fuel elements. Water ensures core cooling and protection from radiation. Every storage channel can contain the equivalent of a dozen cores of the aircraft carrier. After staying in the pool for a dozen years, spent fuel will be brought to other long-term storage devices.

The “utility canal” allows monitoring and experimental measurements to be performed on fuels. Its main experimental device is the gammametry bench, which measures the burn-up of fuel elements following their stay in the reactor.

The storage pool was commissioned in October 2005. Its technical operation is ensured by AREVA TA. The first fuel elements were transferred in early 2006.

RES and its environment

The basic nuclear installation classified as secret for nuclear propulsion (INBS³-PN) at CEA/Cadarache gathers the whole of test and support equipment required for the missions assumed by the Nuclear Propulsion Division of the CEA's Military Applications Directorate.

The activities relating to the operation of nuclear facilities generate liquid and gaseous effluents which undergo appropriate treatments: radioactive liquid effluent management and treatment in specialized plants, very high efficiency filtration of gaseous effluents. The latter are periodically released following the issue of an effluent release permit. The implementation of the RES program test reactor is taken into account in the new effluent release permits of CEA/Cadarache.

An evaluation of the impact of these releases in normal conditions has been calculated for the whole of the facility.

As for any regulated nuclear facility, a safety case has been submitted for approval to the Defense Nuclear Safety Director. This report includes an evaluation of the radiological impact of yearly liquid and gaseous releases in normal conditions. This evaluation is performed through computer codes that take account of wind regime around Cadarache as well as of populations' diet habits in the neighboring of the site.

These codes help evaluate impacts through atmospheric, water and land paths. Given the measures taken as early as in the design and operation stages, the doses received by populations living near the facility are very low, and comply with current standards.

Thus, the maximum dose due to the facility has been assessed to be 0.0006 mSv/year. This value is to be compared with the average natural radioactivity in France, which is 2.4 mSv/year.

3. INBS: a French Acronym for *Installation Nucléaire de Base Secrète*.

Research reactors: tools for the benefit of basic research, industry and health. Neutron diffraction, isotope production, neutron activation, neutron radiography and semiconductor doping

As mentioned above, research reactors are first of all tools, and it has soon become obvious that neutrons so generated could have multiple applications outside the so-called nuclear area.

The most outstanding application fields are detailed hereafter:

Fundamental (basic) research

As the latter always needs highly performing tools, it has very soon undertaken to use neutrons generated by research reactors for investigating matter. For neutrons have penetration and interaction properties which allow matter to be explored at the atomic and molecular scale.

These properties have led to develop high-performance specialized reactors that have been implemented to study solid state physics, magnetism, crystalline structures, molecular and macromolecular physicochemistry, biochemistry, and biology.

Neutron scattering and diffraction as a tool for exploring matter

Neutron radiation

Neutron diffraction is a method for investigating matter. During the latest 50 years, it has become an indispensable technique for research. For neutrons exhibit unique properties which make them a privileged tool for exploring condensed matter (*i.e.* the two dense generic phases – the solid and the liquid state - as well as all the intermediate forms of matter – “soft matter”):

- As they do not carry an electric charge, neutrons can directly interact with the atomic nucleus. So they exhibit a high penetration capability and can probe all of the atoms of a bulk sample;
- Two isotopes of a same element (undistinguishable by their chemical properties) will have different interactions with neutrons. This property is the basis of differential measurements by isotopic substitution (*e.g.* hydrogen/deuterium);
- Owing to the vicinity of neutron/proton masses, neutrons allow light atoms to be displayed much more easily than when using X rays. This makes it possible to localize hydrogen in molecular crystals, or use neutrons for nondestructive examination.

- Given their rest mass, thermalized neutrons (velocity ranging from 500 to 10,000 m/s) may interact with matter specimens according to wavelengths comparable to atomic distances (between 0.1 and 20 nm), which allows interatomic distances to be measured and molecular size to be determined;
- Thermalized neutrons have a kinetic energy of the same order of magnitude than atomic motion energies in solids and liquids (between 0.1 and 100 meV), so that information about internal vibration modes of matter (phonons) may be drawn through neutron/sample interaction;
- Last but not least, the neutron, though it carries no electric charge, carries its own magnetic momentum (spin 1/2), and is thus an ideal tool for determining the intrinsic magnetic structure of samples by interaction.

Most of these properties relate to quantum mechanics. In order to use them, it is necessary to generate neutrons, prepare them in well defined states (monochromatic beams), focus them on samples of matter, and, finally, collect and analyze scattered neutrons.

By interacting with matter, a neutron can thus experience a change in its propagation direction, its energy, and the orientation of its spin.

Starting from an incident monodirectional neutron beam, scattering by the sample will give birth to secondary beams, the direction of which depends on atomic arrangement. This is what is called “diffraction” or “elastic scattering”, which, for instance, allows the nature of a crystal lattice to be determined.

Moreover, small-angle neutron scattering makes it possible to go back to nanometric-scale heterogeneities (*e.g.* residual stresses in a mechanical part, precipitates in a crystal lattice, etc.).

Interaction with atoms (which in solids vibrate around their equilibrium positions) may also result in a change in neutron energy: this is the phenomenon of “inelastic scattering”. By measuring and analyzing such a change, atomic dynamics can be traced back. Last but not least, interaction with atoms may lead to a neutron spin inversion (by interaction with magnetic momenta of atoms): this is the phenomenon of “magnetic scattering”.

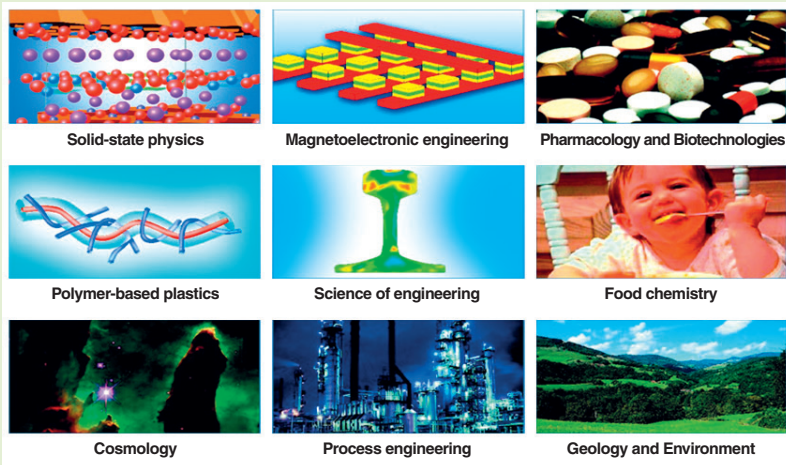

Fig. 9. Application areas of neutron beams.

Neutron beam reactors

At the CEA Saclay Center, the first neutron scattering experiments were achieved on the EL2 reactor (2.4 MW; divergence: 1952; shutdown: 1965), and then the EL3 reactor.

(18 MW; divergence: 1957; shutdown: 1979), which followed the first French pile, the Zoé reactor of Fontenay-aux-Roses (divergence: 1948; shutdown: 1974).

Multipurpose research reactors (specifically dedicated to studying fuels for the various power reactor types) were thus used to extract neutron beams from the core, and bring them to a “dry” ground on experimental areas, outside the reactor pool.

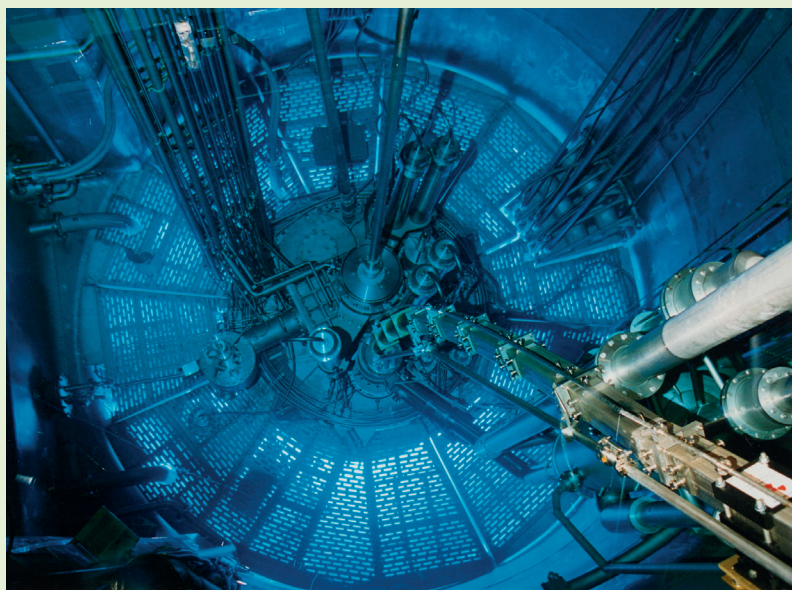

Fig. 10. Top view of the High Flux reactor core at the Laue-Langevin Institute (Grenoble).

Since the 1960s, due to the growing specialization of disciplines, research reactors dedicated to fundamental research (*i.e.*, to scientific applications of neutrons) have been set up in the United States (HFBR - 60 MW, 1965 -, and then HFIR - 100 MW, 1966 -), then in Europe (French-German-British reactor RHF at Grenoble - 58 MW, 1971 -) (fig. 10).

Today, the High Flux Reactor at Grenoble, operated by the Laue Langevin Institute within the framework of a multinational partnership, stands as the most performing continuous neutron source in the world. In addition, in Europe, the huge needs of the scientific community has led to the setting up of several neutron domestic sources, especially the ORPHÉE/LLB facility at Saclay (14 MW, 1980), and, more recently, FRM-II in Germany (TUM, 20 MW, 2004).

Each of these facilities is coupled with a beam research reactor, which is operated as a neutron source, and an experimentation team in charge of developing and operating the spectrometers of the experimental areas. In the case of ORPHÉE/LLB, reactor operation is assumed by the Nuclear Energy Division, and the experimental part by a CEA/CNRS joint unit, the Léon Brillouin Laboratory (a unit integrated in the CEA’s Fundamental Research Division).

Coupled with the first spallation sources (see below, pp. 135-144, the chapter on “Research Reactors in the World”, and see also below, p. 23, the inset on “Pulsed neutron sources and research reactors”), these facilities provide the technological network required to meet the scientific community’s needs, and thus help maintain Europe’s decisive advance in neutron investigation disciplines.

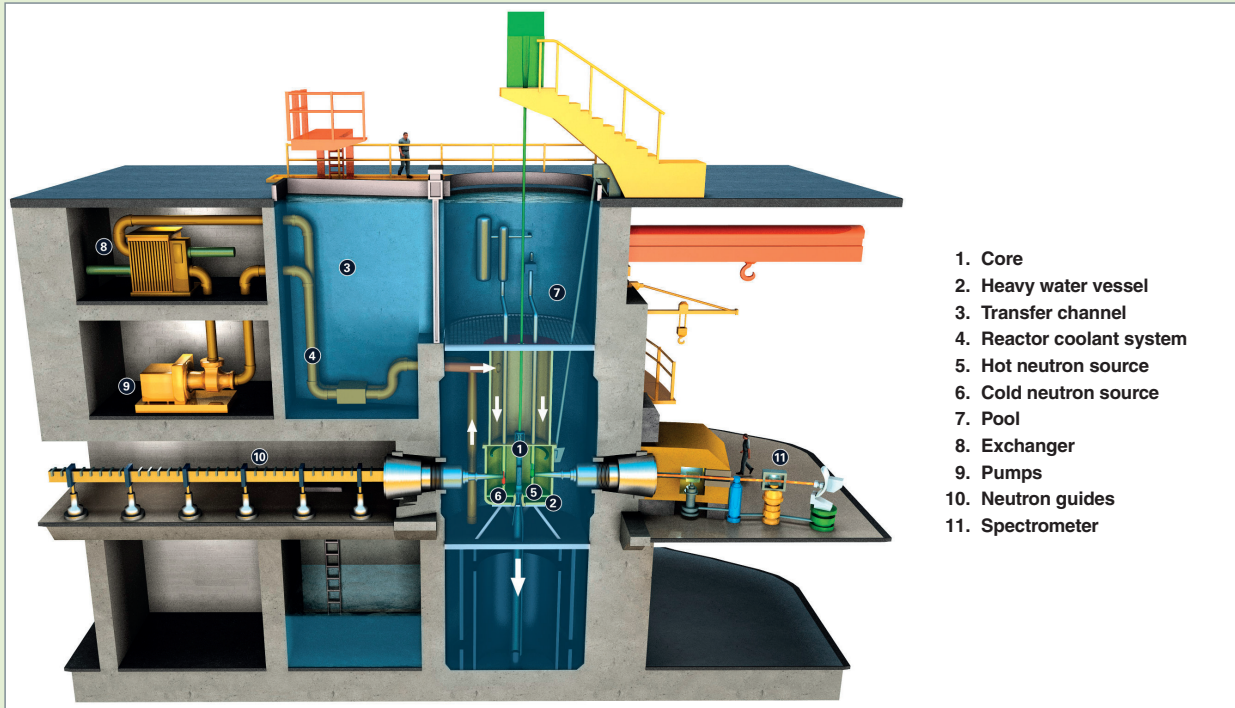

Fig. 11. Sectional view of the ORPHÉE reactor.

The ORPHÉE research reactor at Saclay

The ORPHÉE reactor, designed by the teams of CEA/Saclay and Technicatome (a company now integrated in the AREVA Group), has been under operation at Saclay Center since 1980.

The facility is organized around a 14-MW, plate-fuel compact core immersed at the center of a pool (concept of light-water pool reactor). The whole facility, as well as the core cooling circuit, are gathered inside the reactor containment (fig. 11).

The Orphée design has benefited from the operating experience feedback of the previous facilities, EL3 and RHF in relation to beam reactors, and SILOÉ and OSIRIS in relation to pool reactors. It has thus met three essential criteria: moderate cost, enhanced safety, and research of excellent performance (for the best use of neutrons generated in the reactor core).

The general features of the facility have been selected so as to allow a high number of neutron beams to be extracted.

The reactor core, located in a small vessel 25 x 25 cm and 90 cm high, consists of a central beryllium block surrounded by fuel elements (fig. 12).



Fig.12. The ORPHÉE reactor core is particularly compact, which endows the reactor with high neutron performances.

The light-water cooled and moderated core is placed at the center of a heavy water vessel, which plays the role of both a neutron **moderator*** and a neutron **reflector*** (which contributes to both core neutron economy and the supply of a high thermal neutron flux for scientific applications (3.10^{14} n.cm⁻².s⁻¹) (fig. 13).

The neutron qualities of low absorption and high scattering length that characterize heavy water, make sure the availability of a significant experimental volume to collect neutrons, and direct them towards experimental areas. For this purpose, aluminium-made horizontal channels (the so-called “thimbles”) penetrate the heavy-water vessel up to about 40 cm from the

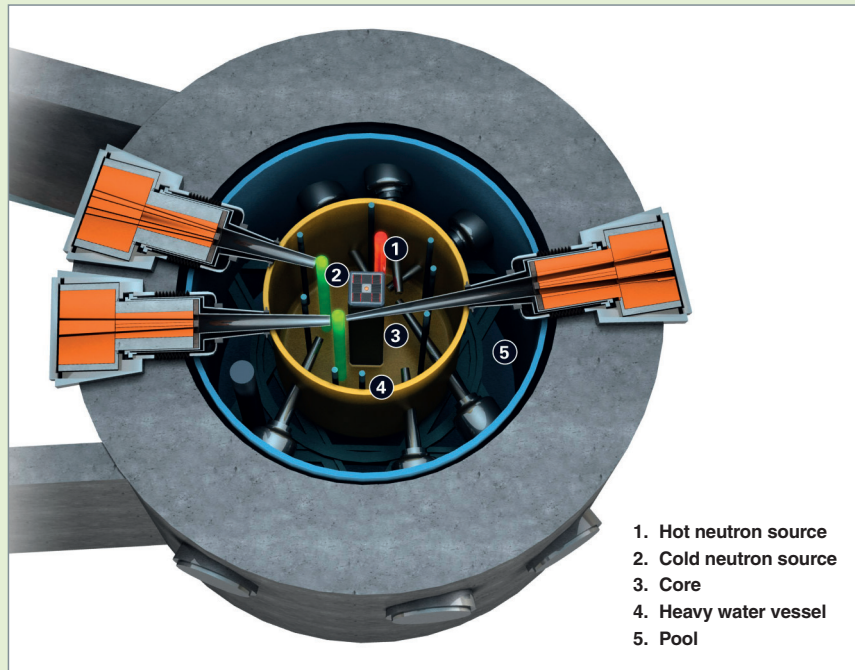

Fig. 13. Top view of the ORPHÉE reactor.

core, directed towards the area where the heat flux is maximum (and in directions tangential to the core, so as to avoid leakage of fast neutrons and γ radiation).

Core height allows 9 horizontal, wide-section thimbles to be placed simultaneously on 3 levels. These thimbles, in turn, make it possible to extract from the reactor cavity 20 neutron beams, to be directed to 26 experimental areas.

The neutron flux maintained in the heavy water vessel mainly contains thermalized neutrons with an energy of about 25 milli electronvolts (meV). In order to provide either low-energy (<5 meV), or high-energy (> 100 meV) neutrons for the experiments, "secondary" moderators are used. These devices, positioned in the heavy water vessel, allow for the neutron energy level to be altered locally (table 2).

So, two cold neutron sources, using 3 intermediate channels, feed 8 cold beams that provide 19 out of the 26 experimental areas of the facility.

Every cold neutron source consists of a gourd-shaped cell containing liquid hydrogen at 20K (-253 °C), placed in a safety containment under vacuum.

Table 2

Characteristics of neutrons generated by ORPHÉE				
	Energy	Coupled velocity	Wavelength (n.m)	Equilibrium temperature
Neutrons issued from fissions in the core	2 MeV	20,000 m/s	2.10^{-5}	Out of thermal equilibrium
Thermal neutrons	0.025 eV	2,200 m/s	0.18	300 K
Cold neutrons (cold neutron source)	0.002 eV	600 m/s	0.68	20 K
Hot neutrons (hot neutron source)	0.120 eV	4,800 m/s	0.08	1,400 K

Similarly, a hot neutron source, consisting of a graphite block heated to about 1400 K (1127 °C) by the γ power deposition from the core, allows 4 hot neutron beams to be fed.

As a second step, a more elaborate selection of useful neutrons is performed: a monochromator collects in the beam the neutrons which exhibit a wavelength within a given band, in order to direct them to the sample to be studied. The other neutrons of the beam (that is 90-99 % of the total

amount) go through the monochromator, and are absorbed in specific materials (the so-called "beam catchers"). The end of the device consists of diffractometers (for measuring neutron changes of direction) and spectrometers (for measuring neutron energy levels) installed around each experimental station.

The experimental areas (fig. 14) are arranged either in a specific zone, i.e. around the reactor cavity inside the reactor, or in a much broader experimental hall (the so-called "guide hall") neighboring the reactor containment. In the second case, specific devices, neutron guides, are used to transport neutron beams over several dozens of meters. Neutron guides (hollow glass blocks covered with a nickel multilayer) allow beams of very low incidence to be propagated according to a principle similar to that of an optical fiber.

In addition to its main scientific function, ORPHÉE is also a facility designed to achieve applications oriented to industry or medicine.

For instance, since the early age of the reactor, one of the neutron beams is used to perform a neutron radiography non-destructive testing of pyrotechnic components for the space industry (Ariane rockets).

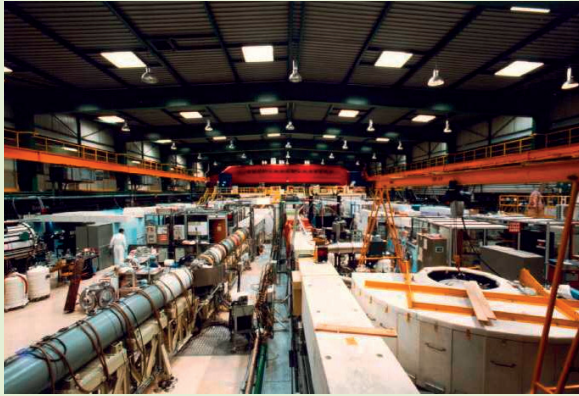

Fig. 14. The experimental hall of the Orphée reactor with its neutron guides in the foreground.

In the reactor cavity, where nine vertical channels are available, four are used for activation analysis, and five for radioisotope production (ex.: iridium and tantalum for medical applications) or silicon ingot doping (Si/P transmutation) for the semiconductor industry.

Over 30 years or so of operation, the ORPHÉE reactor (which is currently operating on a basis of about 200 days/year), has proved to be a reliable facility, both very robust (through its safety features and the simplicity of its design), and very flexible (regarding the range of possible experiments). The facility underwent two safety reviews in the late 1990s and in 2008-2010. Continuous tailoring of its potential to the needs of experimental areas has allowed ORPHÉE /LLB to keep a leading position in many neutronics disciplines while ensuring the training of successive generations of young researchers in neutronics techniques.

Together with the SOLEIL synchrotron (commissioned in 2006 on the Saclay Plateau), the ORPHÉE facility takes part in the technological network available on the Saclay Plateau, which is expected to become one of the most important pools of research and higher education tools in France.

Pulsed neutron sources and research reactors

Research reactors are excellent intense neutron sources, but there exists other processes for extracting neutrons from atoms. One of them is spallation, which consists in bombarding a target made of a heavy element, such as tungsten, with very high-energy particles generated by an accelerator (typically, protons with an energy of the order of 1 GeV). During this very violent shock, some constituents of the target nuclei are ejected, among which is a high number of neutrons. This type of source is generally pulsed, and allows very intense neutron fluxes to be reached for very short times. Even if, till now, the average fluxes of these sources are much lower than those of reactors, they are still of interest for investigating condensed matter. For time-of-flight determination of the neutron emission wavelength can be easily carried out owing to the time structure of the emission, and, contrary to reactor experiments, it is then no longer necessary to use a monochromator which absorbs a great part of the available beam. Another interest of these sources lies in the fact that the heat to be removed per neutron generated in the target is about seven times lower than in a reactor, which makes its cooling easier. However, the powerful particle accelerator they require, entails difficulties in their development and high operational cost.

A few leading countries have recently started to build new, high-power spallation sources. Thus, SNS came into operation at Oak Ridge (United States) in 2006. This source, with a 2 MW power, currently is the most intense pulsed source in the world, and the neutron scattering systems which it is equipped with, could soon go beyond the performance of those installed on RHF, the current reference reactor in Grenoble. This was followed in 2008 by the startup of J-Parc, a 1-MW source, in Japan. This is characterized by the sharing of a high-energy proton beam among several different targets so as to distribute operating costs. China, too, has launched a construction project for a smaller source, CSNS, which is to be set up near Shanghai.

As regards Europe, it can count on the English source ISIS near Oxford. This has been recently upgraded through the launch in 2008 of a second target specialized in the use of long wavelength neutrons. In terms of flux, however, it is still lagging far behind the American source (fig. 15).

There also exists a fairly ambitious project of new, high-intensity source (5 MW): this is the project named "ESS" (European Spallation Source). It is expected to endow Europe with a spallation source of prime importance.



Fig. 15: Top view of ISIS, the English pulsed source located at the "Rutherford Appleton Laboratories" at Didcot, near Oxford. The two experimental halls can be seen in the foreground, each of them containing a different target.

Production of radioisotopes for medical and industrial uses

In most cases, the production of these radioelements does not require specific reactors; for research reactors exhibit a broad range of reactor types and powers, and can so produce artificial radioelements for multiple uses, in parallel to conducting their experimental programs. One field has become particularly important: this is the field of radioelements for medical use, due to its social impact. The radioelements so produced are used either for medical diagnosis, or for direct care through destroying malignant cells.

Artificial radionuclide production

The discovery

The Physics Nobel Prize was attributed to F. Joliot following the discovery of artificial radioactivity in 1934. The first artificial **radionuclide***, also called "radioactive isotope", was obtained by subjecting an aluminium foil to an α radiation from a natural polonium source. The phenomenon involved was transmutation, *i.e.* a process in which the final atom produced is of a chemical species different from that of the initial atom. Here, aluminium is turned into phosphorus, an unstable element which emits a β^+ radiation and is so turned into stable silicon. The nuclear reaction is then as follows:

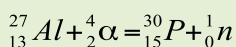

Artificial radionuclide production

The main tools for producing artificial radionuclides are nuclear reactors and accelerators (cyclotrons or linear accelerators). The first are generally used to produce artificial radionuclides with an excess of neutrons, the second, artificial radionuclides with a neutron deficit. Nearly 50 nuclear reactors and 300 accelerators distributed among 30 countries are assessed to regularly produce artificial radionuclides in 2011.

Most of accelerators are operated by private companies, mainly for medical uses. In contrast, almost all the nuclear reactors producing artificial radionuclides are focused on research or teaching, and are operated by the public sector.

In a reactor, there are two alternatives for production:

• Producing radionuclides by activation

The target to be irradiated generally consists of a pure product (powder, thread...) encapsulated in a quartz bulb which is inserted in a protective tube made of crimped or welded aluminium. This cylindrical tube, ~10 cm long, with a standard diameter $\varnothing = 2.5$ cm is used for remote handling: insertion and removal from the reactor, and then recovery in a hot cell. The "activated" product is then purified, fractionated, and conditioned prior to being sent to the end user.

Over one hundred of different artificial radionuclides may be produced by activation. As a neutron capture is involved, the production yield is directly proportional to the neutron flux level and the irradiation time. The latter has to be the shortest possible so as to limit the activation of secondary isotopes, which constitute undesirable impurities.

• Producing artificial radionuclides by fission

In this case, the target to be irradiated is made of uranium. The artificial radionuclide is a fission product (FP). Each fission results in twenty or so FPs on the average, each one with a yield of about 5 %.

The selective separation of usable FPs requires a radiochemistry workshop. But this process is reserved for industrial-scale

applications, e.g. medical uses, due to its high cost. In order to get satisfactory production yields and limit the waste volume, it is necessary to use ²³⁵U-enriched uranium targets.

Given the operating constraints (target cooling, very high radioactivity, voluminous packagings...), the production by fission of artificial radionuclides for medical uses is restricted to a small number of reactors (six in 2009).

Using artificial radionuclides in industry

A number of economic sectors, particularly the industry and medicine, commonly use artificial radionuclides produced in reactors. Artificial radionuclides for industrial applications usually have a long radioactive half-life, and are supplied as sealed sources. Four application segments can generally be distinguished:

• Nucleonics instrumentation

This involves measuring instruments containing radioactive sources that emit α , β , or γ radiation, or neutrons, as well as X-ray thickness gages, security instrumentation (explosive detectors...), devices for measuring pollutants or for oil slick detection, tank gages, etc.

Main isotope: **C-14, Fe-55, Ni-63, Kr-85, Pm-147, Tl-104, Am -241, Cf-252.**

• Radiosterilization

The aim is to use artificial radionuclides with a high specific activity, particularly **Co-60**, for medical equipment sterilization, irradiation of food in order to improve its hygienic quality, and plastic materials vulcanization.

It is worth mentioning that Co-60 with a high specific activity is practically no longer produced in research reactors, but rather in power reactors (India, Canada, Russia). Consequently, cobalt control rods are recycled.

• Radioactive tracers

A radioactive tracer mixed with the same natural substance occurring in a process helps determine its efficiency, detect material transfers, follow titrations, etc. These tracers are used in chemical laboratories, the petroleum industry, ore mining, sediment transfer in estuaries...

Main isotopes: **H-3 (tritium), C-14, Na-24, Au-198.**

• Nondestructive examinations

The main application of this segment is the inspection of thick parts for which X radiation is not sufficiently penetrating: parts welding in boilermaking, foundry, aeronautics, civil engineering...

The main isotope used is **Ir-192**. Neutron imaging with **Cf-252** is worth to mention, too.

Last but not least, it is worth to mention systems with **Po-210**, used to remove static electricity in processes for manufacturing paper, plastic films, etc.

The industrial sector accounts for the highest volume of artificial radioactivity produced in reactors. For reasons of public security, industrial techniques based on radioactive sources tend to be replaced, wherever it is possible, so as to mitigate the risk of malevolent uses.

Using artificial radionuclides in the medical industry

Medical applications of artificial radionuclides encompass two fields: diagnosis and therapy. In France, over 200 hospitals include a nuclear medicine unit in which artificial radionuclides are the basic product.

Diagnosis techniques

Nuclear imaging provides information about how many organs function. This is a noninvasive technique which completes X radiation or magnetic resonance imaging, the latter generally providing anatomical images. Nuclear imaging can be used for quite a number of pathologies, such as cancer, cardiovascular and cerebral troubles, bone pathologies, infectious diseases...

Main isotopes: **Tc-99m, I-131, Xe-133, H-3, C-14, Ru-97, I-125.**

80 % of examinations are carried out with Tc-99m. This 140-KeV γ -emitter isotope, with a 6-hour half-life, is issued from Mo-99 decay. Molybdenum can be incorporated into a number of "vector" molecules due to its chemical valences. These molecules are administrated *in vivo*: the γ radiation is detected by a SPECT (Single Photon Emission Computed Tomography) gamma camera, and allows the pathology to be precisely localized up to 1 mm or so (fig.16). The interest of Tc-99m lies in the low dose delivered to the patient thanks to its rapid decay.

For these examinations, nuclear medicine units are fitted with Mo-99/Tc-99m generators that can be used for one week or so (Mo-99 half-life is 66 hours).

Over 25 million Tc-99m examinations are reported every year all over the world (1 million in France).

Large-scale production of Mo-99 requires three steps:

- In-pile irradiation of enriched-uranium targets;
- Separation of the fission product Mo-99;
- Purification and conditioning in Mo-99/Tc-99m generators.



Fig.16. Tc-99m bone scintigraphy

Since 2011, five high-power research reactors, among which OSIRIS at Saclay, supply over 95 % of the Mo-99 used in the world. A 6th reactor is to start production in Australia. The whole of alternative techniques for producing Mo-99, e.g. neutron capture on Mo-98, only marginally contribute to meet world needs, and can rather be used locally.

Therapeutic applications

This corresponds with the treatment of some disease with the help of medicines named “radiopharmaceuticals”, or of targeted therapies using the ionizing property of β and γ radiations.

β : synovitis, restenosis (arterial pathology), palliative care (bone cancers)... Main isotopes: **Y-90, Sr-90, Re-186, Er-169, Cu-64, Sm-153.**

γ : cancers. Main isotopes: **Co-60, Ir-192** (used as sealed sources).

The future of artificial radionuclides

Large-scale use of artificial radionuclides in industrial and medical areas has been developing for over fifty years or so thanks to the availability of research reactors financed and operated by state-owned establishments. Besides, various research programs make use of artificial radionuclides, or require to develop new ones according to the properties of interest (radiation type and energy). The need for in-pile production of artificial radionuclides for industrial and medical uses will remain strong as long as alternative methods cannot substitute for them with the same efficiency.

In the medical field, therapies based on radiation use remain indispensable in some fields (oncology), where they complete other care. Regarding diagnosis, expected needs for Tc 99m are increasing all over the world. Alternative imaging techniques do exist, such as positron emission tomography (PET), which require a cyclotron. Today, however, these techniques are much more costly for the same service.

Given the situation of the main reactors currently producing Mo-99, all of them over 40, risks of extended shortage of Mo-99 are to be expected in the coming years. The emergence of alternative techniques apart from reactors will take several years at least. So, whether new reactors mainly dedicated to Mo-99 production are to be built, is an issue to be considered by public powers.

Neutron activation analysis

This application is based on measuring the radiations emitted by the radionuclides formed by neutron bombardment in any sample of matter. It allows the sample composition to be determined, especially for tiny element traces lower than 1 microgram per gram. The implementation of this technique is relatively simple, and is achieved in quite a number of research reactors.

Neutron activation: a powerful tool for trace detection

Neutron activation analysis (NAA) is a powerful nondestructive testing tool for measuring traces in solid or liquid samples arising from the environment, the food industry, metallurgy, electronics, pharmacology, etc. NAA is based on the measuring of radiation (*i.e.*, most often, gamma radiation, but also, sometimes, beta radiation emitted by the radionuclides formed by neutron bombardment (fig. 17).

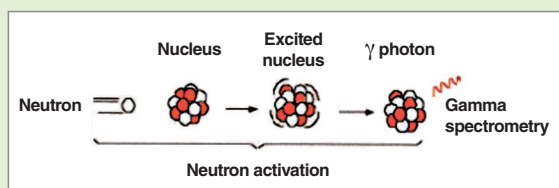

Fig. 17. The principle of neutron activation reaction.

NAA consists in putting each sample with standard samples in an ultrapure polyethylene casing, and then in putting the latter in a polyethylene shuttle for a time determined according to the radionuclide half-lives, radiological considerations, and so the sample composition. The shuttle is irradiated, and the elements contained in the samples react by neutron capture, thereby producing radioisotopes. The energy emitted by the radionuclide through radioactive decay, and measured by γ spectrometry, indicates from which element the radioisotope produced is issued, and radiation intensity at this given energy is directly proportional to the amount of this element.

Initially, NAA was used jointly with chemical processing of samples, but advances in γ spectrometry have allowed most of elemental analyses to be achieved without any chemical processing. Hence the preference for the term “instrumental NAA”, instead of “radiochemical NAA”.

The main NAA advantage for complex matrices lies in that the technique may be made highly selective. For, during irradiation, the radioisotope is produced with a yield described by the activation equation, and decreases according to a half-life

related decay yield. After a t time elapsed since the end of irradiation, the measured radioactivity is as follows [1, 2]:

$$A = \frac{M C_A \theta N \Phi \sigma_{AB} (1 - e^{-\lambda t})}{M e^{\lambda t}}$$

where

- M is the mass of the irradiated sample,
- C_A is the mass concentration of the element,
- θ the isotope content (atoms),
- Φ the neutron flux (number of particles per area unit and time unit),
- N the Avogadro number ($N = 6.023 \times 10^{23} \text{ mol}^{-1}$),
- σ_{AB} the neutron capture **cross section*** (or resonance integral in an **epithermal*** flux),
- λ the disintegration constant of the radioisotope
- t the irradiation time
- M the atomic mass of the element

Neutron flux and energy may vary. The broader the neutron flux, the higher the number of interactions. The elements with a high neutron capture cross section in the thermal energy range are very sensitive in a thermal flux, whereas those with a high **resonance integral*** are more sensitive in an epithermal energy flux. With two channels in two types of reactors (table 1), CEA/Saclay provides a broad range of possible irradiations according to the sample to be analyzed. Most of NAA applications uses the (n, γ) reaction because of the best sensitivities generally obtained with respect to reactions (n, p) , (n, α) or $(n, 2n)$, which have an energy threshold, and are normally produced only with fast neutrons. Some trace or minor elements (i.e., P, S, B, Be, Cd) cannot be measured by NAA using thermal neutrons (or thermal NAA).

For instance, concerning the analysis of biological samples, some products of reactions (n, γ) do not emit γ rays (i.e. S-35, P-32, Ca-45), or the half-lives of the radioisotopes produced are too short (<1s) or excessively long (400 years) for an accurate measurement in a sensitive medium, or the reaction cross section σ is too low. The detection limit obtained using a specific reaction (n, γ) is also much influenced by the sample composition, for the γ ray measured is superposed to the Compton front resulting from inelastic scattering in the detector of the γ rays issued from the whole of the sample radioisotopes (e.g. ^{28}Na , ^{42}K , ^{38}Cl). In epithermal NAA, the sample is irradiated in an irradiation capsule, which filters thermal neutrons (such as metal

Cd or B as nitride carbide) so as to increase sensitivity. Thus, a radio-isotope generated by a (n, γ) reaction having a high resonance integral with respect to its thermal neutron capture cross section can be measured with a better detection limit.

Moreover, the irradiation time may also vary in order to improve the activation yield of some elements having radioisotopic tracers of short or long half-lives. For instance, as regards aluminium or selenium, the concentrations are obtained after a few minutes, whereas, for other elements, a few weeks' decay time between irradiation and measurement may be required. Differences between half-lives of produced radioisotopes may be used to discriminate the products analyzed in the sample matrix.

About 67 elements can be determined at concentrations of the order of parts per billion (ppb), with an uncertainty lower than 5 % and a reproducibility better than 1.5 % for samples varying from 100 mg to a few grams. Thirty elements can be simultaneously analyzed without any chemical separation whatever the matrix.

If the sensitivity for minor elements and traces in a high number of matrices and the multielemental response of neutron activation are now comparable with other spectroscopic methods (**AAS***, **ICP-MS***, and even **TR-XRF***), NAA is still interesting given its self-control feature and its easy adaptation to numerous types of samples [4]. It is very useful for analyzing volatile elements, halogens, or "difficult" elements such as Au, As and Se, but some elements of interest such as Pb, Nb, and Y are better determined with other techniques.

There is a very broad range, indeed, of NAA applications. Yet, trends may be identified.

Beyond historical applications (geology, archeology), environmental sciences (air pollution, food, geology, materials, inorganic elements, water) can in turn make a broad use of NAA to analyze samples through computer codes of data banks relating to the environment or biomedicine (tissue tracers, implant corrosion) (fig. 18). NAA accuracy is needed for analyzing ultrapure technological materials such as catalyzers, or semiconductors (Si, C in relation to the photovoltaic industry). As it can be performed within a short time, NAA is currently used for forensics, the pharmaceutical industry, or health control.

Table 3

Values of neutron fluxes ($\text{cm}^{-2} \cdot \text{s}^{-1}$) in OSIRIS and ORPHÉE reactor channels (CEA/Saclay) [3]

Reactors	OSIRIS		ORPHÉE		
	H ₁	H ₂	P ₁ and P ₂	P ₃	P ₄
Thermal neutrons (E = 0.025 eV)	0.77×10^{14}	1.2×10^{14}	1.23×10^{13}	1.65×10^{13}	2.5×10^{13}
Epithermal neutrons (E > 0.1 eV)	1.9×10^{12}	4×10^{12}	6.15×10^9	8.25×10^9	4.5×10^{10}
Fast neutrons (E > 0.5 eV)	9.6×10^{12}	2.3×10^{13}	3.5×10^9	8.2×10^9	1.2×10^{10}

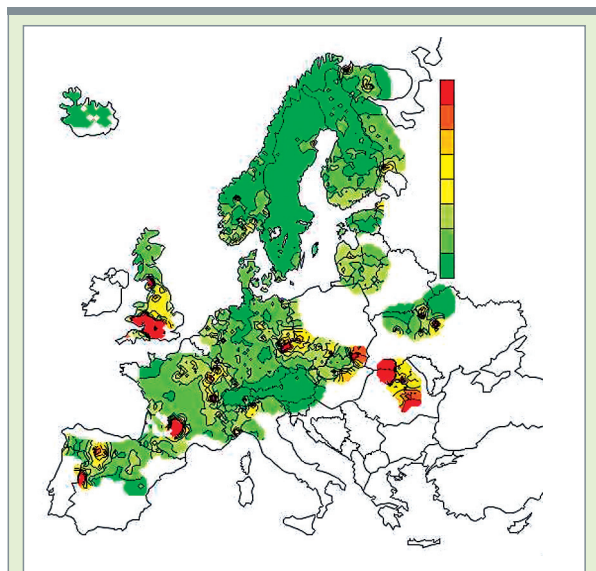

Fig. 18. An example of application of neutron activation analysis: mapping of arsenic iso-concentrations (mg/g) analyzed in mosses in Europe (Activation in the ORPHÉE reactor at Saclay).

Neutron radiography

This is a technique similar to radiography, but using the neutron property to be stopped by light nuclei (hydrogen, boron, lithium...), which allows light elements to be “seen” through heavy materials interposed as a screen (fig. 19).

Neutron radiography is implemented in research reactors not only to get information about the samples of components qualification programs, but also to carry out nondestructive examinations on the industrial scale.

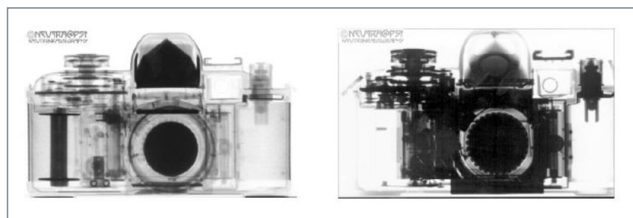

Fig. 19. An example of neutron radiography (left) and X-ray radiography (right) of a camera. Both techniques are almost perfectly complementary. While X radiography allows heavy atoms to be seen, neutron radiography gives access to the lightest atoms, such as hydrogen, which always prevail in the objects of our environment (plastics...).

Doped silicon production

The irradiation of silicon monocrystalline ingots alters the structure of this material, and turns it into a semiconductor. After such “doping”, silicon can be used in industrial electronics for high-quality products, especially in the car industry.

Silicon doping with neutrons

The discovery and the principle

Silicon, a semiconducting metalloid, is used in electronics to fabricate active components or detectors. For these applications, it is often used as a “doped” element by incorporating a few parts per million of a chemical element: boron (type P: electron acceptor) or phosphorus (type N: electron donor). A result similar to doping can be obtained by irradiating silicon with neutrons. The neutron doping process was first mentioned by Lark-Horovitz in 1951. But its use was then limited to a small number of research projects and to the production of a very high resistivity silicon for nuclear particle detectors. The process was developed on an industrial scale in the seventies, in Denmark (Risø), and then in Great Britain (Harwell).

Monocrystalline silicon doping

For silicon of common quality used at low voltage, doping is made in a vacuum oven in which a gas bearing phosphorus or boron is diffused during the fabrication process. The doping quality obtained with these methods is generally not sufficient when strong currents and voltages go through power electronic components (Table 4): there is a risk of breakdown. It is then necessary to use neutron transmutation doping (NTD) of silicon. This method makes it possible to create an impurity, phosphorus, which acts as an electron donor, in a particularly homogeneous manner, within silicon (fig. 20).

The principle of neutron transmutation doping

Silicon includes 3 natural isotopes Si-28 (92.2 %), Si-29 (4.7 %), and Si-30 (3.1 %). Under irradiation and by capture of a thermal neutron, a Si-30 atom becomes an unstable Si-31 atom, which undergoes disintegration into a stable P-31 atom following the emission of a β^- particle (radioactive half-life of 2.62 hours). That is, silicon has been transmuted into phosphorus.

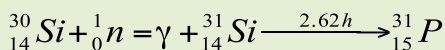

Only a small part of Si-30 atoms - about 1-10 ppm - needs to be transmuted to produce a given resistivity range (table 5). Practically, the industry provides monocrystalline silicon bars of

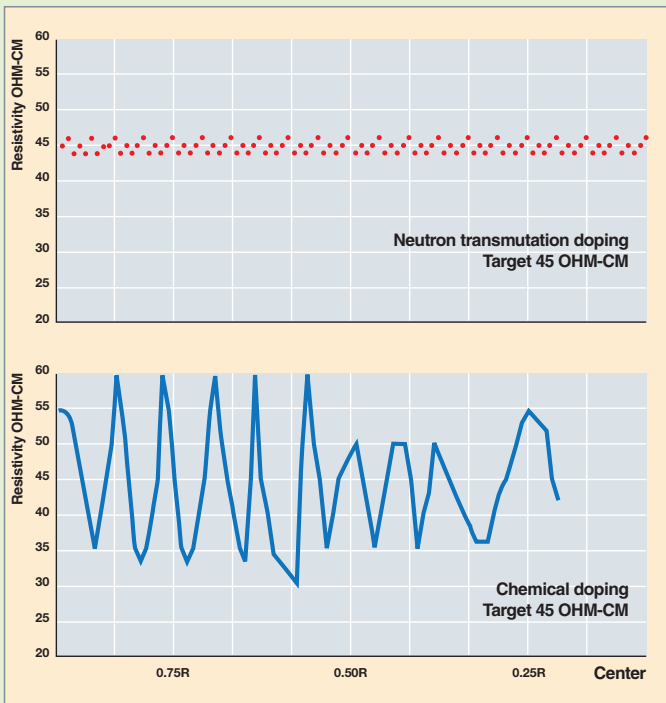

Fig. 20. Variation in radial resistivity after a neutron or chemical doping.

4-8 inch diam. (fig. 21) for reactors. Two types of **irradiation devices*** are used to ensure doping homogeneity, while adapting themselves to the features of each reactor:

- Rotative devices fitted with an axial flux flattening system;



Fig. 21. Silicon ingots.

they are sawed, ground, etched, polished, and cut into platelets.

The ultrapure silicon bar remains the only industrial product which, after irradiation in a nuclear reactor, is returned to the producer in its initial box!

- Axial-translation rotative devices.

According to reactors and doses, irradiation times may vary from a few hours to a few days. Following two days of residual radioactivity decay, silicon bars can be handled again. They are returned to the customer for a preliminary annealing operation, intended to repair some damages caused to the crystalline lattice by the irradiation process. Then,

Using NTD silicon in industry

Silicon and its applications in micro-electronics are part of our daily life: cellular telephone, microchip card, microcomputers, etc. What is less known is that silicon is also used for the operation of domestic equipment working at higher voltages and amperages: household appliances, digitally-programmed conditioning systems, lifts, etc., which require NTD silicon. But this is especially the development of high-power electric engines that maintains demand: trains, tramways, hybrid or all-electric vehicles (fig. 22).

In 2011, a dozen of research reactors are reported to be equipped (table 6) to meet the world demand, assessed to be about 150 tons per year. The NTD silicon market is shared between four silicon "founders", that is three in Japan and one in Europe. Demand focuses on thermalized neutron spectra due to their doping quality.

Table 4

NTD silicon: power electronic components

Power component	Typical application
MOSFET	Power supply systems for microcomputers, televisions, Hi-Fi equipment, control devices for cars, etc.
IGBT	Inverters and control devices for lifts (converter/inverter circuits), industrial engines (inverter control systems), conditioning systems, etc.
Blockable thyristors and rectifiers	Inverters and control devices forelectric drive vehicles (inverters), industrial engines (converters), etc., and power supply networks, etc.

Table 5

Resistivity bands for electronic components

Résistivité (ohm.cm)	Composants
15 to 40	Power transistors Diodes for cars Low-voltage thyristors Diode batteries Charge-coupled circuits
40 to 100	Silicon-controlled rectifiers Rectifiers Avalanche diodes
100 to 1,000	Insulated-gate bipolar transistors High-power thyristors Power diodes
5,000 to 20,000	Nuclear detectors

Table 6

Main reactors used for silicon doping (2009)

D ₂ O / Graphite		H ₂ O	
Australian	OPAL	Belgium	BR 2
Japan	JRR 3M	Netherlands	HFR
Norway	JEEP 2	USA	MURR
France	ORPHÉE	France	OSIRIS
USA	MIT	South Africa	SAFARI 1
Korea	HANARO	Poland	MARIA
Germany	FRM II		
Belgium	BR 2		

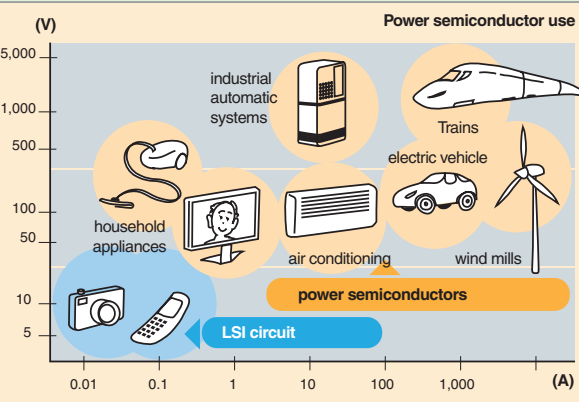

Fig. 22. Overview of the potential uses of doped silicon in power semiconductors

As a conclusion, the multiple uses of research reactors for nuclear power development highlight the fundamental, indispensable role that they have played, and are still playing indeed. In addition, beyond the nuclear field, research reactors induce activities which are now well integrated in our scientific, industrial and social environment.

- André CHABRE,**
Nuclear Energy Division
- Clarisse MARIET, Alain MENELLE,**
*Fundamental Research Division,
Radiation and Matter Institute at Saclay*
- Xavier BRAVO,**
Innovation and Nuclear Support Division
- Alain ALBERMAN,**
Reactors and Nuclear Services Department
- Joseph SAFIEH**
National Institute for Nuclear Science and Technology
- and Philippe JUCKER**
*Division of Military Applications, Joint Technical
Department for Naval Propulsion Nuclear
Steam Supply Systems*

► **References**

- [1] K.H. LIESER, "Nuclear and Radiochemistry, Fundamentals and Applications", Wiley & sons (1997).
- [2] S.J. PARRY, "Activation Spectrometry in Chemical Analysis", vol. 119, in *Chemical Analysis*, Wiley & sons (1991).
- [3] G. REVEL, "Analyse par activation", *Techniques de l'ingénieur, traité Analyse et caractérisation*, pp. 2-565.
- [4] *Use of Research Reactors for Neutron Activation Analysis*, IAEA-TECDOC-1215 (2001).

► **Bibliography**

- Revue *RGN*, numéro hors-série, May-June 1994.
- NIGON (J.-L.), *Techniques de l'ingénieur, Génie nucléaire, théorie des réacteurs nucléaires (B3016)*.
- Id., *Techniques de l'ingénieur. Génie énergétique. Réacteurs de recherche et d'essais de matériaux*.

Table 7

CEA's Research Reactors										
	Power (MWth)	Year of commissioning	Fuel and reactor type	Applications under consideration						
				Teaching	Nuclear data	Neutron diffraction	Materials or components irradiation	Qualification		Production
								Core neutronics	Safety	
Critical mockups for investigating core physics and neutronics										
ÉOLE (Cadarache)	0.0001	1965	UAl Pool		●				● (LWR)	
MINERVE (Cadarache)	0.0001	1959	UAl Pool	●	●				● (LWR and fast reactors)	
MASURCA (Cadarache)	0.5	1966	(U, Pu)O ₂ Air pile		●				● (fast reactors)	
ISIS (Saclay)	0.7	1966	U ₃ Si ₂ Al ₃ pool	●					● (OSIRIS)	
AZUR (Cadarache)	0.0001	1962	U ₃ O ₈ pool	●					●	
Materials test reactors										
OSIRIS (Saclay)	70	1966	U ₃ Si ₂ Al ₃ pool				●			●
JHR (Cadarache)	100	2014	U ₃ Si ₂ Al ₃ pool				●		●	●
Test reactors and prototypes										
RES (Cadarache)	100	2013	U ₃ O ₈ pressurized				●	●	●	●
Reactors for investigating accident situations and safety										
CABRI (Cadarache)	25 (steady state) 20,000 (pulsed state)	1963	UO ₂ pool						● (reactivity-initiated accidents)	
PHÉBUS (Cadarache)	38	1977	UO ₂ pool						● (LOCAs)	
Reactors for basic physics										
ORPHÉE (Saclay)	14	1980	UAl/H ₂ O-D ₂ O Pool			●				

French Research Reactor History

ZOÉ, the first French atomic pile, started operation in 1948

As early as the first research programs for civil and military applications of nuclear energy launched at the end of the II World War, French physicists were aware they could not go ahead without getting a research reactor likely to help, first, understand and control the physical phenomena prevailing in the behavior of neutrons and of materials under irradiation, and, second, produce significant amounts of radioactive elements required for research. In that context, the first French atomic pile **ZOÉ** (fig. 23) diverged at Fontenay-aux-Roses on December 15, 1948.

With a power which was going to progress up to 150 kWth, **ZOÉ** lifetime was distributed between power operating periods for investigating materials irradiation and radionuclide production, and very low power operating periods for physicists to measure neutron properties in the constitutive materials of the “**piles***” of this age (graphite, control absorbers, structural materials...).

The need to get specialized tools according to the applications under consideration thus emerged quite early.

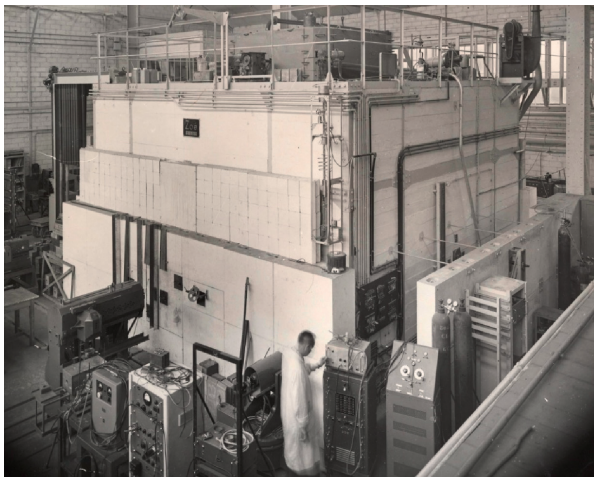

Fig. 23. ZOÉ, the first French atomic pile, at the Fontenay-aux-Roses site.

- **Critical mockups for neutron studies**, characterized by a high operating flexibility, easy access for measurements, the evolutivity of their geometry, and a power nearly equal to zero so as to avoid structural activation-related constraints and fuel wear;
- **Irradiation reactors**, of significant power (a few dozens of MWth), dedicated to investigating irradiation effects on nuclear fuels and structural materials, as well as to producing radioisotopes for medicine and industry. The design of those reactors very quickly focused on the “pool” type likely to conciliate core cooling and operating and experimenting flexibility;
- **Safety test reactors** likely to help investigate the consequences of accident situations with respect to nuclear fuels and radionuclide release. In order to simulate such situations, that was the concept of coupled core which became the reference from the very start, being, likely to deposit a high amount of energy on the experimental component;
- **Prototype reactors or industrial demonstrators**, with a power of a few dozens to several hundreds of MWth, designed to validate the technological options, operating conditions, and safety features of a reactor type prior to building the first nuclear power station.

The fifties or the study of the early reactor types

In the fifties, CEA physicists’ main concerns were oriented to three objectives:

- Improving nuclear data knowledge for the (heavy water- or graphite-moderated) natural uranium reactor type, the only industrial reactor type accessible to the country as long as it does not have the uranium enrichment abilities likely to “ease” the core reactivity balance. That was the main aim of reactivity measurements and lattice studies carried out on the reactors **ZOÉ** at Fontenay and **AQUILON** à Saclay (fig. 24);



Fig. 24: AQUILON, a critical mockup used to qualify nuclear propulsion reactors.

- Developing as soon as possible a reactor type able to ensure propulsion of French nuclear submarines. That was also the objective of, first, **AQUILON** and then, from 1959, of the critical experiment **ALIZÉE** at Saclay (consisting of enriched uranium bars and light-water moderated);
- Starting the studies of a “homogeneous” reactor type (i.e. with a liquid fuel), which appeared as one of the most promising solutions at that time, especially with respect to the spent fuel treatment issue. That was the objective of experiments on **PROSERPINE**, which diverged in March 1958 at Saclay. The studies chiefly dealt with determining the kinetic parameters of very reactive systems (the basis of safety-criticality studies), but also with searching the minimal critical masses (PROSERPINE has won the record of the smallest pile in the world, with 257 g plutonium and 410 g uranium 235). Those studies have been pursued by the criticality station of the French Valduc protection and nuclear safety Institute, IPSN (IPSN: Institut de protection et sûreté nucléaire).

That age was also that of large-scale future-oriented projects, with; for instance, the “atomic plane” and the “atomic engine”. These last two required the achievement of a compact core, whose early concepts were studied on the critical experiment **RUBÉOLE**, using low-enriched uranium oxide as fuel, and beryllium oxide as moderator.

In parallel, the first technological irradiation and research reactors were set up at Saclay with **EL2** (2.5 MWth) in 1952, followed by **EL3** (18 MWth) in 1957. Both were based on the design of a heavy-water moderated, very low-enriched uranium core.

During the same period, it is worth to mention the startup at Marcoule of the first three reactors of the natural uranium fuel, graphite-moderated, and CO₂ gas-cooled reactor type (**UNGG**⁴): **G1** (divergence in 1956), **G2** (1958) and **G3** (1959). These reactors were devoted to a twofold mission of production of the first nuclear power kilowatts and of plutonium, but also proved to be indispensable tools for developing and qualifying fuels for the future EDF reactors in this reactor (fig. 25).

The late fifties are a turning point for our physicists. They become aware that optimizing reactor neutron performance makes it necessary to drop simplified formulations, such as the famous formula of the four factors to calculate the **multiplication factor*** k_{∞} , and to refer directly to the true basic parameters, i.e. the **cross sections*** of the core constitutive components.

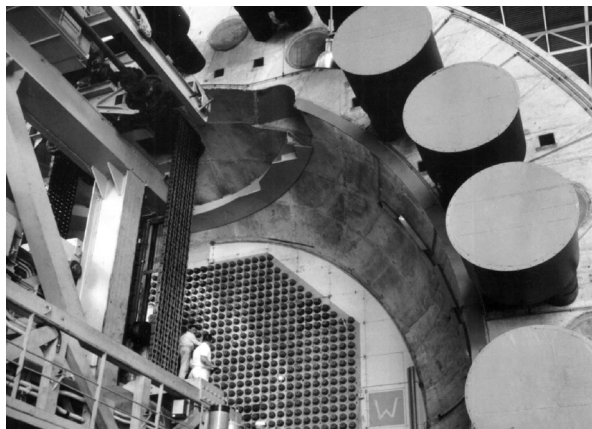

Fig. 25. The plutonium breeder G2 at the Marcoule site.

This is all the more obvious as, in that age, the Saclay Center is the cradle of experimental neutronics, benefiting from the presence of a pioneer team (J. Yvon, J. Horowitz, G. Vendryes, and J. Bourgeois), and the numerous reactors operating on the site. Thus was decided the construction of the **MINERVE** pile, which diverged in 1959 at Fontenay-aux-Roses, and whose objective was measuring neutron parameters (**neutron spectra***, **resonance integrals***, **reactivity*** effects) using the experimental techniques developed then, such as miniature fission chambers, activation detectors, and the oscillation technique, that nowadays still stand as standard measuring methods.

4. UNGG: a French acronym for *Uranium Naturel-Graphite-Gaz*.



Fig. 26. ÉOLE, a critical mockup for studying water-cooled reactor cores.

The flourishing age of the sixties

The first part of the sixties stands as *the* great French age of research reactor construction and critical experiments. For those years are inserted between two periods: a period of strong demand, with the joint developments of several industrial reactor types (**UNGG***, **heavy-water reactors***, **fast neutron reactors***, **light-water reactors*** for naval propulsion), and a period when computational tools and method developments were still insufficient, and required the achievement of critical mockups with characteristics very close from industrial reactor cores. Thus, within the category of “reactor-type” **critical mockups***, up to six new mockups were set up between 1960 and 1965: **MARIUS** and **CÉSAR** for the gas-graphite reactor, **HARMONIE** and **MASURCA** for fast neutron reactors, **ÉOLE** for heavy water reactors (fig. 26), and **AZUR** for naval propulsion reactors.

Reactor studies relating to the *UNGG* “national” reactor type prevailing then were conducted on the reactors **MARIUS** and **CÉSAR**.

- **MARIUS**, initially built on the Marcoule site and transferred to Cadarache in 1965 was designed, first, for the basic neutronics studies of graphite-moderated cores, and, second, for the parametric studies of UNGG core lattices using the so-called “substitution” method, *i.e.* progressively modifying the fuel element lattice without changing the reactor core. The neutron qualification of components for future power reactors also took place there;
- **CÉSAR**, a reactor designed to operate under temperature conditions, was first dedicated to studying graphite-moderated lattices, under the operating temperatures of UNGG-type reactors (lattice studies, measurement of temperature

coefficients and, through oscillations, of irradiated fuels...) (fig. 27). Then, from 1971, **CÉSAR II** was oriented to lattices of high-temperature reactors (pebble cores, prismatic lattices...) as part of the studies conducted on high-temperature reactors (HTR).

As regards studies on the fast neutron reactor type (*RNR: Réacteurs à Neutrons Rapides*), the **HARMONIE** source reactor and the **MASURCA** critical mockup started up almost simultaneously at Cadarache.

- **HARMONIE** diverged in 1965. With its original design, featuring a 93 %-enriched uranium mobile kernel that can be removed from the shields, experimental canals allowing for a broad variety of neutron spectra, and the possibility to achieve pulsed-mode experiments, **HARMONIE** stands as a very precious experimentation tool, especially to carry out the first neutronics qualifications of shielding materials for fast neutron reactors;
- **MASURCA**, which is dealt with in a special chapter of this book (see below p.55-60), diverged in 1966, and constitutes the major critical benchmark to investigate fast neutron reactors (fig. 28). As its size allowed to achieve cores containing up to 2 tons of plutonium, it was so considered a reference tool for studying space phenomena and qualifying “project” parameters relating to the future prototypes of fast neutron reactors, such as PHÉNIX et SUPERPHÉNIX.

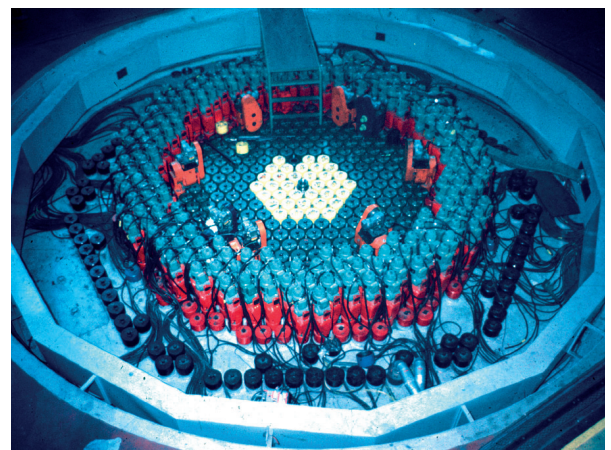

Fig. 27. CÉSAR, a critical mockup for studying gas-graphite reactors.

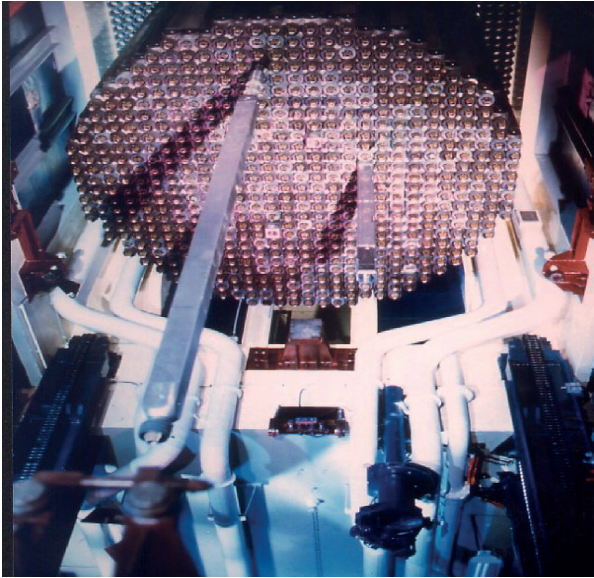

Fig. 28. MASURCA, a critical mockup for studying fast neutron reactors.

In addition to these “reactor type”-oriented critical mockups, it is worth mentioning the critical mockups designed to validate the cores of our irradiation reactors, such as **PEGGY** for PEGASE, **SILOETTE** for SILOÉ, **ISIS** for OSIRIS, as well as other more specific achievements, such as **ALECTO** at Saclay (for the early criticality studies), **RACHEL** at Valduc (a fast neutron critical experiment with strictly military objectives), **NÉRÉIDE** at Fontenay-aux-Roses (for radiation protection studies), and, last but not least, **ULYSSE** at Saclay (for teaching).

In 1966, **MASURCA divergence*** concluded that major age of critical mockup construction, mainly because, from now on, computational method development and computer code performance made it possible to extrapolate results from small-sized lattices to the prediction of neutron characteristics in power reactors cores.

Considering **irradiation reactors**, the highly enriched (90 % ^{235}U enriched) uranium made available by the United States as early as the late fifties was to compensate for the major weakness of heavy-water reactors, in which the fast neutron flux proved insufficient to investigate damage in structural materials. The first pool-type research reactors named MTRs (Material Test Reactors), of high compactness and flexibility, were thus set up referring to the American model: first, **MÉLUSINE** (8 MWth) in 1958 at Grenoble, and then **TRITON** (6.5 MWth) in 1959 at Fontenay-aux-Roses.

The bursting needs in irradiation then led to the launch of 3 pool reactors, with a typically French design and a significantly higher power: **PÉGASE** (30 MWth), which diverged in 1963 at Cadarache, and was designed to perform a full-scale test of the fuel elements of the gas-graphite reactor type; **SILOÉ** reactor (35 MWth), whose divergence took place in the same year on the Grenoble site, and which proved to be an outstanding tool to investigate fuel properties under irradiation thanks to the associated heavy devices (dismantling cells, hot laboratory) until its was shut down in late 1997; and, last but not least, **OSIRIS** (70 MWth), which started operation at Saclay in 1966, and is still operating today (fig. 29). **OSIRIS** will remain the basic tool to develop the pressurized-water reactor fuels of the EDF fleet till around 2015, when the Jules Horowitz reactor succeeds it at Cadarache.

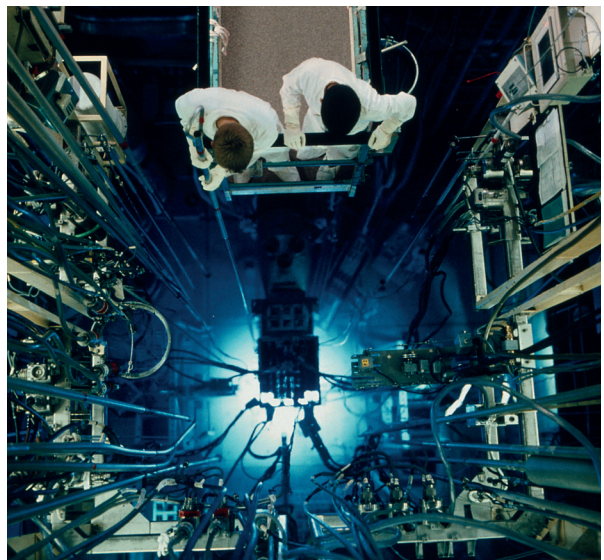

Fig. 29. Top view of the pool reactor OSIRIS used for materials and fuels irradiation.

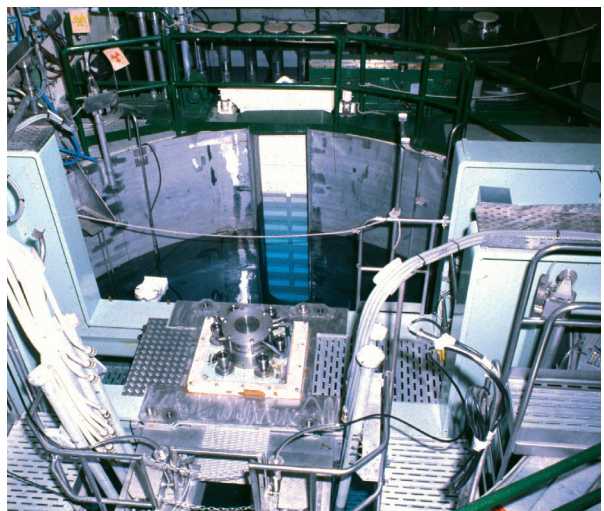

Fig. 30. CABRI, a research reactor dedicated to safety studies.

In that period, two new tools also started at Cadarache in the same year 1963, which were to play a very important role in research on French reactors: first, **RAPSODIE** (25, then 40 MWth), which was the **first fast neutron research reactor** using plutonium fuel and liquid sodium coolant, and then, in late 1963, **CABRI** (42 MWth), the **first reactor dedicated to safety tests** (in relation to, initially, loss of cooling accidents of fast neutron reactors, and then reactivity-initiated accidents of pressurized-water reactors) [fig. 30].

The seventies' major achievements

The last experimental reactor constructions of the XXth century took place in the seventies, with 3 large-scale achievements that were to bring a decisive scientific and technical benefit in the 3 following fields:

- In the field of fast neutron studies, **PHÉNIX** (560 MWth, 250 MWe), which diverged in 1973 at Marcoule and, while being the first power prototype of fast neutron reactors, stood as the basic irradiation tool for this type of spectrum until its scheduled shutdown in late 2009 (fig. 31). So, in 35 operating years, over 200 irradiations could be achieved in it, thereby entailing outstanding progress in the fuel elements of this reactor type, with their maximum **burn-up*** increased by a factor 2 (and a record at 144,000 MW-d/t, *i.e.* nearly 3 times more than in a current water-cooled reactor), as well as demonstrating the ability of this reactor type to burn long-lived radionuclides by transmutation;

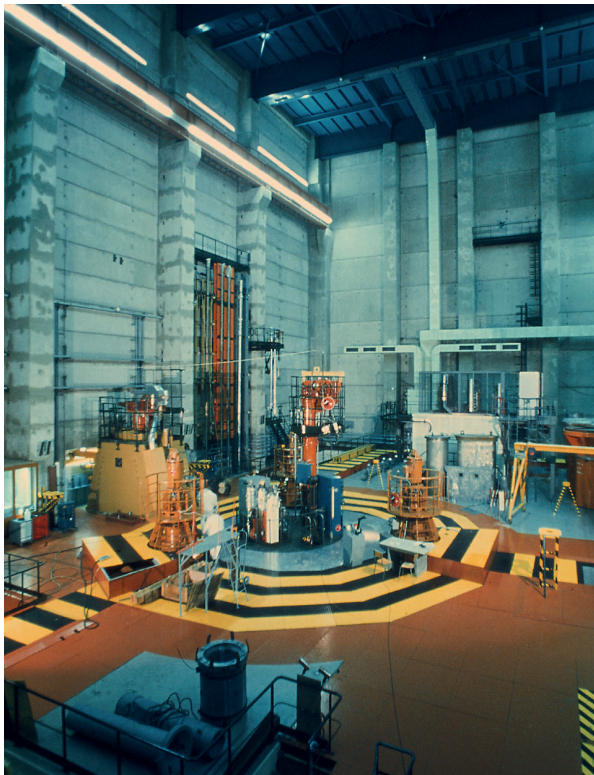

Fig. 31. PHÉNIX, a fast neutron research reactor.

- In the safety field, **PHÉBUS** (40 MWth), which started up in 1978 on the Cadarache site, and until its shutdown in late 2007, stood as the world reference tool for investigating PWR loss of cooling accidents with core melt and simulation of fission products release in the core and the reactor containment;
- In the field of naval propulsion reactors, the **CAP** (*Chaudière Avancée Prototype: Advanced Prototype NSSS*), which diverged in 1975, and ensures the technological qualification of all the fuels on nuclear steam supply systems (NSSS) of the French Navy. After ensuring the qualification of MOX fuels (mixed oxides of uranium and plutonium) for the French nuclear fleet PWRs for a few years, the **CAP** started new tests for naval propulsion, using then a configuration with improved performance named **RNG** (*Réacteur Nouvelle Génération: New Generation Reactor*), to be shut down in 2005. Future programs will be ensured by the new **RES** (*Réacteur d'Essais au Sol: land-based test reactor*), under construction (last stage) at Cadarache.

So, with **PHÉNIX** being shut down in late 2009, the first decade of the 21th century experienced the shutdown of these three major instruments, each of which, in their respective fields, had fully met the objectives for which they had been designed and set up.

What about the future of research reactors?

Today, the whole of French reactors dedicated to research for the various reactor types developed in France (nuclear power and naval propulsion) are concentrated at Cadarache, except for the **OSIRIS** irradiation reactor located at Saclay (to be shut down in this decade) and those designed for safety-criticality studies at Valduc.

In the field of **critical mockups**, tools for research in neutronics are concentrated around 4 mockups with specific characteristics: **AZUR** for studies of naval propulsion cores, **ÉOLE** for studies of water-cooled core lattices, **MASURCA** for studies relating to fast neutron reactors, and, finally, **MINERVE** for integral measurements of nuclear data, especially through the oscillation technique.

The **ÉOLE**, **MASURCA** and **MINERVE** reactors are indispensable for the development of nuclear power reactors, whether the Generation II of the currently operating fleet, or the Generation III with the EPR, or the Generation IV, for which studies have started with a view to its deployment by 2040. So these reactors are to be significantly upgraded in the coming years so that their lifetime may be extended in the future decades.

Critical mockups

Neutronics is one of the most paradoxical disciplines of reactor physics. For, on the one hand, it can base on an accurate modelling thanks to Boltzmann equation. But, on the other hand, physicists are faced with such a problem, due to the very strong variation in neutron cross sections depending on neutron energy (1 MeV - 20 MeV), and to high number of parameters involved (relating to chemical elements, cross sections...), that the differential measurements of nuclear data prove insufficient, and it seems necessary to implement integral measurements in research reactors. Moreover, the complexity of the geometries and nuclear phenomena involved requires the use in the computer codes of approximations that it is indispensable to validate.

With this very purpose are **critical*** experiments performed. They use small reactors which are to display a very high flexibility of use (evolutivity of core geometry) and a safe operation. Access for emplacing the instrumentation is made easier by their reduced size and volume and, as the power released is rather low, it induces low core radioactivity, limited activation of structures, and no fuel wear.

These critical experiments allow research of important parameters (critical size, boron concentration), measurement of reaction rates (**material and geometric buckling***, power distribution, **neutron spectrum***...) by activation detectors or miniature fission chambers, and measurement of reactivity effects (cells, fuel substitution, absorbers, temperature coefficients, fission products, irradiated fuels...) by doubling time or oscillations.

Thus were achieved a high number of critical experiments at the CEA, that is twenty or so from ZOÉ (which diverged in 1948 at Fontenay-aux-Roses) to MASURCA, the latest, which started up in 1965 at Cadarache.

In the **field of irradiation reactors**, the **Jules Horowitz Reactor (JHR)**, the divergence of which is scheduled by 2016, will then stand not only as the most performing reactor in the world, but also as one of the last reactors of this type (if not the only) under operation in Europe. The irradiation devices to be introduced into the JHR (see the chapter of this Monograph dedicated to them) will allow this reactor to meet the various challenges relating to materials and fuels qualification for the whole of reactor generations.

As regards naval propulsion, the land-based test reactor **RES (Réacteur d'Essai au Sol)**, which will start up in 2013, will assume the same fuel technological qualification missions than the **JHR**, but for new-generation ships of the French Navy with, still, optimal performance. It will also allow ship teams to be trained.

Jules Horowitz, the father of reactor physics in France

Born on October 3rd, 1921, at Rzeszow (Poland), Jules Horowitz first migrated to Germany. Then, as he faced nazism growth on the other side of the Rhin, he joined France where he was given a brilliant education up to Ecole Polytechnique, where he graduated in 1941. Then German occupation forced him to give up his education, to be resumed in 1946 with a Mathematic Sciences Degree.

On October 1st, 1946, he started working for the CEA, which had been created less than one year ago, and was admitted to the Mathematical Physics Department, in which he contributed to the core calculations for the first French atomic pile ZOÉ.

Invited by Niels Bohr in 1947, he spent one year beside him at the prestigious Theoretical Physics Institute of Copenhagen, and called attention by his top level publications about radioactive decays. In 1949 he became the head of the Mathematical Physics Department.

As a first-rank theorician, he fully embraced that new discipline, reactor physics. "As the creator of reactor physics in France, that unrivaled mathematician was a leading figure for the whole scientific thought in this field", Robert Dautray told of him as he was High-Commissioner for Atomic Energy.

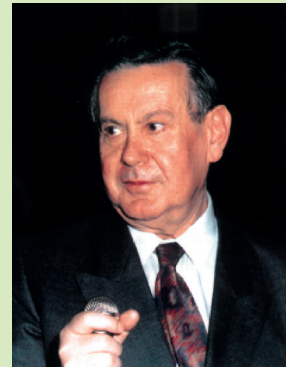

As the head of the Pile Studies Department in 1959, then Director of Atomic Piles in 1962, he was at the initiative of many critical mockups and research reactors which were designed and achieved at that

Last but not least, in the **field of safety test reactors**, the **CABRI** reactor, which completes heavy upgrading works, and now gets a pressurized water loop representative of the French nuclear fleet reactors, will be in the coming years a high-performance tool for qualifying Generation II and III reactor fuels under accident conditions.

Concerning Generation IV, the future of research reactors is named **ASTRID**, *i.e.* the industrial demonstrator of sodium-cooled fast neutron reactors, and **ALLEGRO**, *i.e.* the prototype of the more innovative concept of helium-cooled reactors. The studies on these tools, precursors of tomorrow's reactors for a sustainable nuclear world, have started with a view to commissioning in the next decade.

time, enabling France to get a world-praised knowledge about the whole of reactor types.

As a foreseer with a remarkable intuition, he proposed in a 1967 report to give up natural uranium-gas-graphite (**UNGG***) reactors developed by the CEA, to found the French nuclear fleet on the sole technology of water-cooled reactors, and to set up a single corporate group to achieve them, thereby laying the foundations of today's AREVA.

From 1970 and until 1986, Jules Horowitz steered fundamental research at the CEA, and turned it into an internationally-renowned excellence pool. As part of his work, a whole series of very high-scale research devices and of laboratories were built, which are still ranked at the best world level due to their performance and fame: Laue-Langevin Institute (ILL), with the RHF at Grenoble, Léon Brillouin Laboratory (LLB) with ORPHÉE at Saclay, the Great National Heavy Ion Accelerator (GANIL: Grand Accélérateur National à Ions Lourds) at Caen, the European Source of Synchrotron Radiation Facility (ESRF) at Grenoble, and Frédéric Joliot Hospital Department (SHFJ) at Orsay...

Last but not least, his qualities as a scientist combined with an incomparable negociator's talent and a very accute vision of the orientations to give to science policy in France and Europe. Thus, his contribution was decisive in the rank gained by France in the EURATOM program for controlled fusion, and in the decision to build a great European machine such as JET.

He died when sixty-three years old on August 3rd, 1995, and leaves an outstanding legacy on both the experimental and theoretical ground, including all the fields of nuclear physics, from astrophysics to nuclear medicine. No doubt, however, nuclear physics is the field in which his name will still be a reference for a long time yet.

As a conclusion of this chapter, it is worth keeping in mind the indispensable role of experimental reactors as intense neutron sources, for fundamental research in the field of physics, and more especially of condensed matter structure. Such is the vocation of reactors **ORPHÉE** (14 MWth) at Saclay and **RHF** (*Réacteur à Haut Flux* – 58 MWth) of the Laue-Langevin Institute at Grenoble, which today are still ranked among the most performing tools in the world.

Loïck MARTIN-DEIDIER,
Deputy Director of Nuclear Energy

Table 8

French research reactors						
Reactor name	Localization	Category	Type	Power (MWth)	State	Divergence
ZOÉ (EL-1)	Fontenay-aux-Roses	Research	Heavy water	0.15	Shut down	01/12/1948
EL-2	Saclay	Test	Vessel	1 - 2.5	Shut down	27/10/1952
G1	Marcoule	Prototype	UNGG	40	Shut down	05/01/1956
AQUILON	Saclay	Critical mockup	Heavy water	0	Shut down	11/08/1956
EL-3	Saclay	Test	Heavy water	14 - 18	Shut down	05/07/1957
MÉLUSINE	Grenoble	Irradiation	Pool	1-8	Shut down	01/07/1958
PROSERPINE	Saclay	Criticality tests	Homogeneous solution	0	Shut down	1958
ALIZÉE	Saclay	Criticality tests	Light water	0	Shut down	1959
RUBÉOLE	Saclay	Criticality tests	Compact core	0	Shut down	1959
TRITON	Fontenay-aux-Roses	Irradiation	Pool	6.5	Shut down	29/06/1959
MINERVE	Fontenay, then Cadarache	Criticality tests	Pool	0	Operational	29/09/1959
MARIUS	Marcoule, then Cadarache	Criticality tests	Graphite	0	Shut down	01/1960
NÉRÉIDE	Fontenay-aux-Roses	Research	Pool	0.5	Shut down	15/09/1960
RACHEL	Valduc	Criticality tests	Fast neutrons	0	Shut down	1961
PEGGY	Saclay	Criticality tests	Pool	0	Shut down	1961
ULYSSE	Saclay	Teaching	Argonaute	0.1	Shut down	27/08/1961
AZUR	Cadarache	Criticality tests	Vessel	0	Operational	09/04/1962
SILOÉ	Grenoble	Irradiation	Pool	15 - 35	Shut down	18/03/1963
PÉGASE	Cadarache	Test	Vessel	30	Shut down	04/1963
CABRI	Cadarache	Safety tests	Pool	25 (permanent)	Under upgrading	06/1963
SILOETTE	Grenoble	Criticality tests	Pool	0.1	Shut down	02/1964
PAT	Cadarache	Test	Pressurized water	Unreleased	Shut down	14/08/1964
CÉSAR	Cadarache	Criticality tests	Graphite	0	Shut down	01/12/1964
HARMONIE	Cadarache	Source reactor	Vessel	0	Shut down	08/1965
ÉOLE	Cadarache	Criticality tests	In-pool vessel	0	Operational	02/12/1965
ISIS	Saclay	Criticality tests	Pool	0.7	Operational	28/04/1966
CRONENBOURG	Strasbourg	Teaching	Argonaute	0.1	Shut down	22/11/1966
OSIRIS	Saclay	Irradiation	Pool	50 - 70	Operational	08/09/1966
EL-4	Brennilis	Prototype	Heavy water	267	Shut down	12/1966
MASURCA	Cadarache	Criticality tests	Fast neutrons	0	Operational	12/1966
RAPSODIE	Cadarache	Test	Fast neutrons	40 - 70	Shut down	01/01/1963
RHF	Grenoble	Research	Heavy water	58	Operational	07/1971
PHÉNIX	Marcoule	Prototype	Fast neutrons	560 - 310	Shut down	31/08/1973
SILÈNE	Valduc	Criticality tests	Homogeneous solution	(permanent)	Operational	06/1974
MIRÈNE	Valduc	Criticality tests	Homogeneous solution	(permanent)	Shut down	06/1975
CALIBAN	Valduc	Criticality tests	Homogeneous solution	(permanent)	Operational	1970
PHÉBUS	Cadarache	Safety tests	Pool	38	Shut down	09/08/1978
CAP/RNG	Cadarache	Test	Pressurized water	Unreleased	Shut down	24/11/1975
ORPHÉE	Saclay	Research	Pool	14	Operational	19/12/1980
SCARABÉE	Cadarache	Safety tests	Pool	0.1	Shut down	01/07/1982
RES	Cadarache	Test	Pressurized water	Unreleased	Under construction	2013
JHR	Cadarache	Irradiation	In-pool vessel	100	Under construction	2016

Instrumentation for Research Reactors

Inherently, a research reactor will need instrumentation much more than a power reactor. For a research reactor is generally used either for neutronics studies requiring elaborate measurements, or as an intense neutron source for irradiation. For this purpose, it has to house devices, to be inserted inside or in the peripheral part of its core, which allow experiments to be performed, each of them requiring an adapted instrumentation.

A research reactor will contain a certain number of measuring instruments in support to operation, and others developed to meet the needs of R&D or irradiation programs. Each device inserted in a dedicated canal will include its own diagnostics adapted to the physical parameters to be assessed under neutron bombardment. Most of these measurements are neutronic (**activation***, **capture***, **fission***, **delayed neutrons***), thermal (temperature, released power, conductivity), mechanical (elongation, swelling, creep, rupture), or chemical (gas release, corrosion, impurities, **radiolysis***). In addition, the experimental conditions in which these measurements are performed, have to be qualified correctly. Hence the need to instal additional detectors able to perform real-time measurement of local neutron or gamma fluxes, heating phenomena, and flow rates, all the more as these quantities are most often upset by the sole presence of the device.

In addition to the needs relating to normal reactor operation, the operator is expected, just as power reactors, to meet demands from the Safety Authority relating, in particular, to neutronics features sur as the **criticality*** level, **reactivity*** margins, or safety rod efficiency. For this purpose, he relies on one or several neutron measuring channels which require high-accuracy calibration. Associated uncertainties, to be integrated in the calculation of the corresponding margins, will direct impact on the reactor design and fine control. Besides, a specific instrumentation (dosimeters, detectors, thermocouples, sensors) will also be installed, most often on site, to meet specific operational needs. It will prove a precious help for the design basis of the devices and the optimization of their locations, thereby improving the management of the research tool.

One must distinguish the instrumentation positioned outside the core (the so-called “ex-core instrumentation”) from that positioned inside (“in-core instrumentation”). The specificity of in-core instrumentation lies in its being able to assume its main measuring function while undergoing a very intense neutron and gamma bombardment (fig. 32).

The specificity of in-core measuring systems is especially related with the constraints to be taken into account for their design and integration. In particular, this instrumentation has to exhibit the following features:

- **Miniaturized**, owing to the low useful sections of experimental devices; in-reactor devices have to be installed in a few-millimeter space;
- **Reliable**, for maintaining or repairing irradiated objects is very difficult, or even impossible in most cases;
- **Accurate**, due to even more growing scientific needs: for instance, dimensional measurements carried out on in-reactor samples have to be able to detect micrometer variations;
- **Nuclear radiation-hardened**, as nuclear radiation causes damage (electric insulator degradation, wiring failure, change of properties in probe materials), changes in composition by transmutation, stray currents, and detector heating;
- **High temperature-resistant** (with operating temperatures higher than 300 °C);
- **Corrosion-resistant**: in-reactor experiments are generally conducted in pressurized water or liquid metal (NaK).

In order to meet these specifications, precautions have been taken for selecting materials (so as to use metals and ceramics with appropriate nuclear properties) as well as the measuring methods used (comparative methods or online calibrations are privileged). Whenever possible, measuring systems are transferred out of the neutron flux.

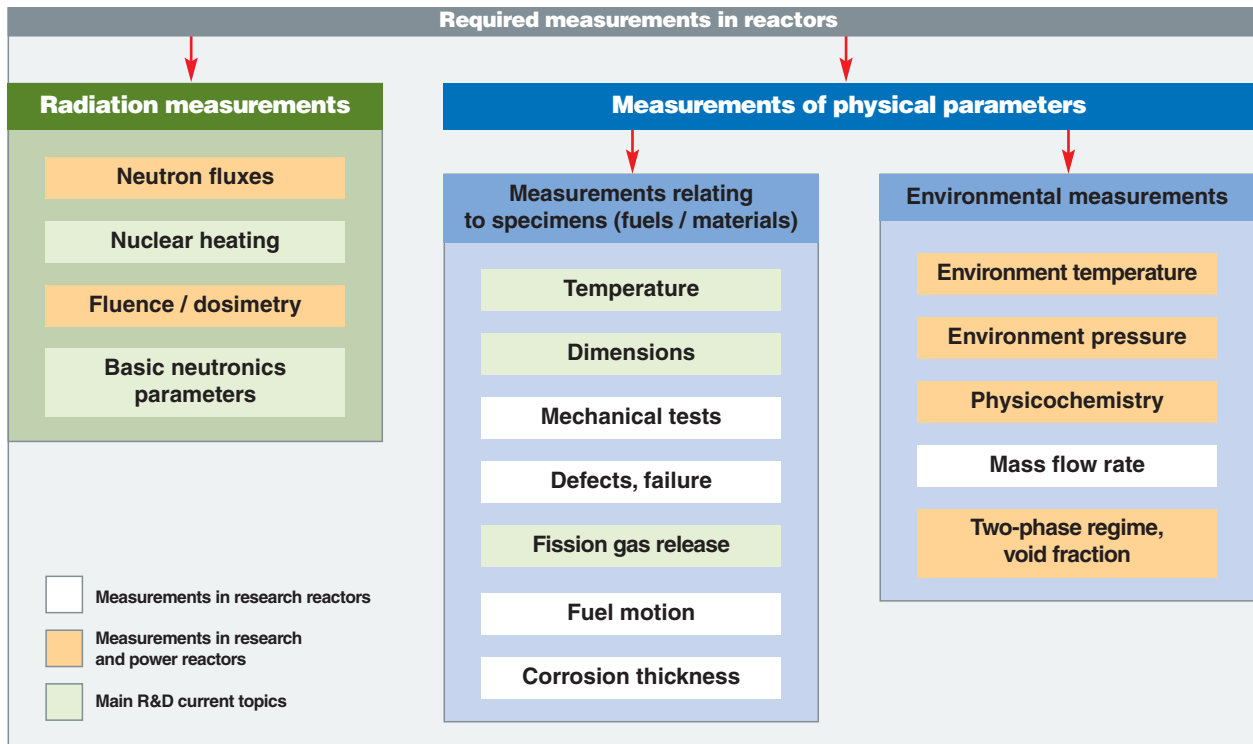

Fig. 32. In-core measurements required for reactors.

Neutron measurements

Activation dosimeters provide the reference measure, by far the more accurate, of neutron fluxes and fluences in research reactors. That implies using a sample of a known metal which is put at a given place (cobalt for measurements in a thermal spectrum, and niobium, iron, copper, or nickel, in a fast spectrum). A gamma spectrometry will be achieved on the sample activated by neutron capture following irradiation, thereby providing the integral of the flux received during the experiment. The main drawback of activation dosimetry lies in its being a post-irradiation, and so out-of-line, measurement.

For online measurements, most of neutron detectors used are based on a chamber filled with a gas which is ionized under the action of a charged particle. These gas detectors provide both high dynamics and high time stability. More particularly, they are far less sensitive to radiation damage than semiconductor detectors. They are also preferred to liquid or solid scintillators, because they are less upset by gamma radiation. These in-core neutron measurements are mainly based on the use of either **self-powered neutron detectors*** (also referred to as collectrons), or fission chambers.

The Self-Powered Neutron Detector (also named SPND because it does not require a polarized supply) uses the measurement of the current generated in a coaxial detector by radioactive element decay, which is itself generated in the

detector by neutron capture (fig. 33). This is an online measurement, but in most cases, it is slightly delayed as a function of the radioactive half-life of the generated element. This robust sensor allows simple measurement of thermal neutron flux.

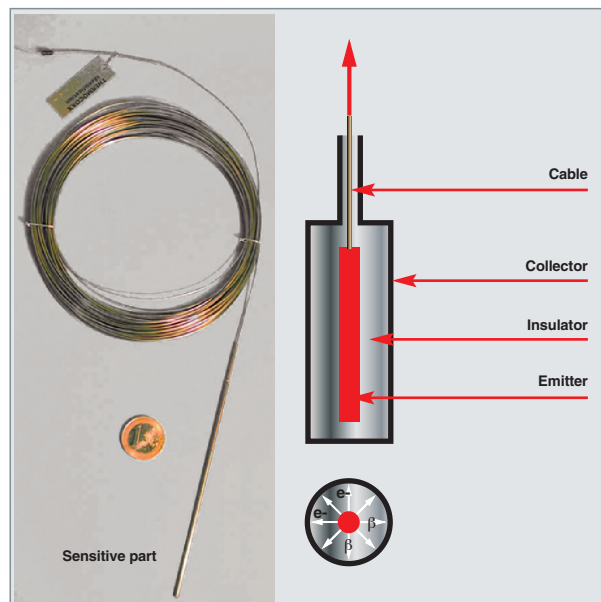

Fig. 33. Self-Powered Neutron Detector.

The **fission chamber** is based on measuring the current which is induced by the ionization of a gas by fission products, the latter being generated in a fissile deposit made on an electrode (e.g. uranium 235). Being of a more delicate design than a self-powered neutron detector, this detector, however, allows online, real-time (without delay) measurement of the fission rate with a higher efficiency than self-powered neutron detectors. The deposit evolution under intense neutron flux has to be taken into account to maintain a good accuracy in measurement.

Developments of miniature fission chambers

Fission chambers with an outer diameter of 1.5 mm, the so-called “subminiature” chambers, were designed and developed at the CEA in order to meet the specific constraints of research reactors, especially in terms of space and measured flux level (fig. 34). A complete test program allowed these detectors to be qualified under conditions relevant for research reactors and power reactors. In parallel, an agreement for licence was signed in 2005 with the PHOTONIS Company for industrializing these detectors.

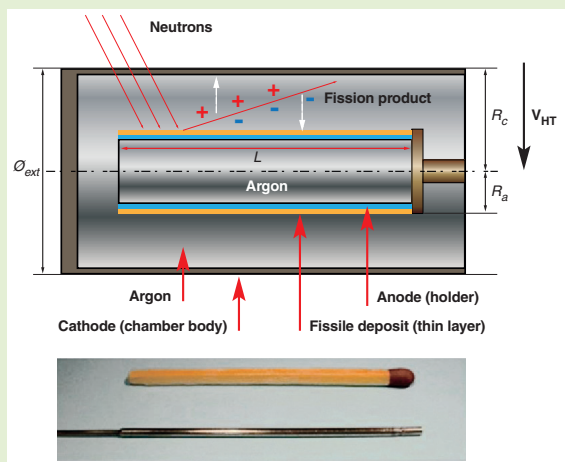

Fig. 34. Fission chambers.

In addition, a measuring chain designed for online follow-up of the fast neutron flux, named FNDS (Fast Neutron Detection System) was developed and qualified at a CEA-SCK.CEN Instrumentation Joint Laboratory. This device is based on the use of a special plutonium 242-lined fission chamber (the interest of plutonium 242 is that this isotope provides a good response in the fast neutron range, but it exhibits low sensitivity to thermal neutrons, even when the deposit evolves under irradiation). The detector is controlled in a specific mode, the so-called “fluctuation” mode, which minimizes the gamma radiation contribution to the signal.

Several times patented, FNDS allows the fast component of neutron flux to be directly reached for the first time, and improves in-reactor measurement quality, thereby increasing competitiveness of CEA/DEN’s research facilities.

Ex-core neutron measurements conventionally use **boron-lined chambers**, in which lithium and alpha particles generated by boron capture can be detected. These chambers are often compensated to minimize the gamma radiation contribution to the signal (one part of the chamber is boron-lined while the other is not, so that the discrepancy between signals accounts for the contribution of the sole neutron flux).

Thermal measurements

Temperature measurements generally involve the use of conventional metal-clad, oil-insulated **thermocouples** (fig. 35). Yet, alternative techniques have been investigated and tried in research reactors, among which the following:

- **Ultrasound** measurements based on temperature evolution with the propagation velocity of an acoustic wave in a material;
- Thermal noise measurements, that is a *primary* measurement using thermal stirring of electrons in a conducting element;
- **Pyrometric** measurements based on the optical detection of high-temperature materials infrared emission.

Operation in irradiation reactor has recently started for innovative thermocouples developed by CEA/DEN to meet the needs of long-term, high-temperature experiments, which use molybdenum and niobium alloys (two elements withstanding high temperatures, and displaying low neutron-capture cross sections).

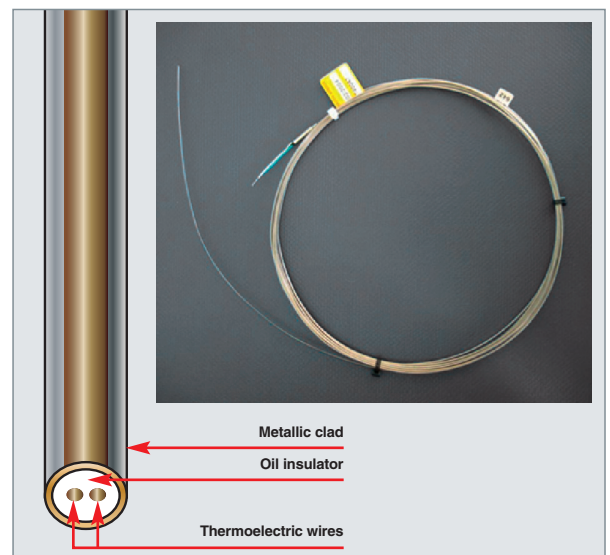

Fig. 35. Oil-insulated, metal-clad thermocouple.

Mechanical measurements

If measuring the deformations of specimens under irradiation was formerly based on various techniques such as HF resonant cavities and stress gages, today most of research reactors use magnetic sensors of type **LVDT** (Linear Variable Differential Transformer), which display the advantage of great robustness and good accuracy (fig. 36). The measurement is based on the variation of the magnetic coupling between two electric windings, this variation being correlated to the deformation of interest (according to the sensor geometry, this may be a variation in length or diameter). Optimizing the signal control and processing mode of these sensors has helped improve the performance of these measuring systems, especially with respect to their sensitivity to temperature and irradiation.

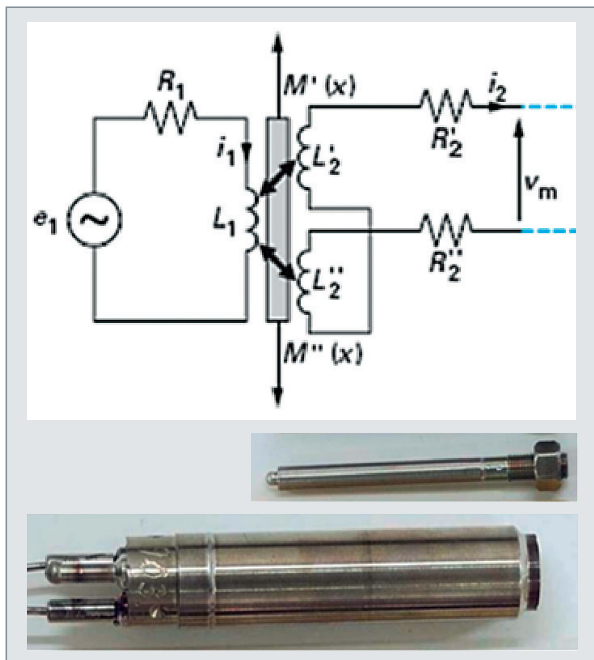

Fig. 36. Magnetic sensor LVDT (Linear Variable Differential Transformer) used to measure in-reactor strains or motions.

Concerning innovations, miniature **optical strain sensors*** recently developed at the CEA-SCK.CEN Instrumentation Joint Laboratory exhibit the advantage of a very low intrusion, for their diameter does not exceed a few hundreds of micrometers (fig. 37). Introducing optical systems into reactors was made possible thanks to the results of the test programs relating to optical fibers under irradiation, such as the COSI experiment in the CEA/Saclay OSIRIS reactor. In 2006, this test cycle evidenced the excellent behavior under irradiation of some fibers made of very pure silica in a given wavelength range, thereby paving the way for the use of optical sensors in a nuclear reactor.

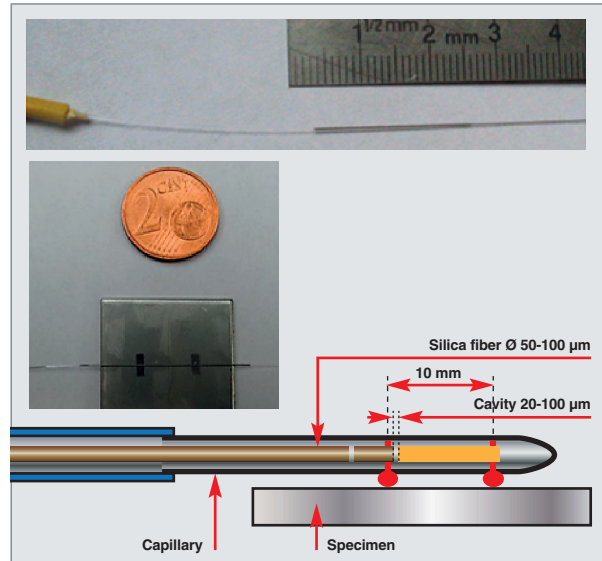

Fig. 37. Optical sensor used to measure elongation.

Fission gas release measurements

Traditionally, the evaluation of fission gas release in fuel rods was merely based on the simultaneous measuring of internal rod pressure and fuel temperature. However, a mere pressure measurement cannot inform about the nature of released gases, though such information is necessary to understand the alterations undergone by fuel during irradiation. This is the reason why the CEA, in collaboration with the Institut d'Électronique du Sud and SCK.CEN, has developed, and now uses, an **acoustic** measuring system, which allows real-time follow-up of the molar mass and pressure of the gas contained in experimental fuel rods (fig. 38).

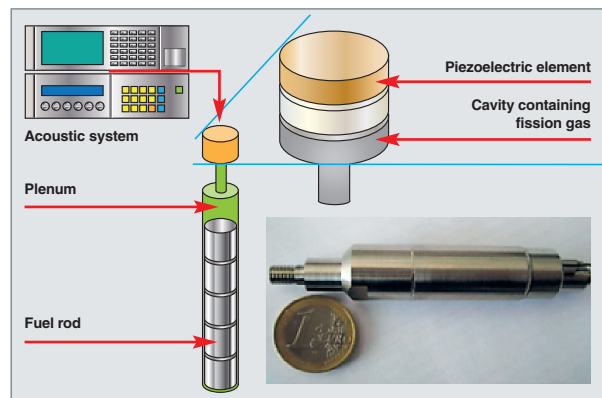

Fig. 38. Acoustic sensor for fission gas release.

Henri SAFA
Scientific Division
and Jean-François VILLARD
Reactor Research Department

Validating Neutronics Calculations

As previously mentioned, as soon as the nuclear field started to develop, reactor physics required experimental tools to qualify the physical models used to investigate the propagation and behavior of a neutron population within a lattice, and thus validating design basis calculations for reactor cores.

These tools, initially called “piles” (a term issued from the piling of graphite blocks to get the first core divergence and a controlled chain reaction - Enrico Fermi - December 1942), are now known under the name “ZPR”, standing for Zero Power Reactor, or “Critical Mockup” (in French, “*Maquette critique*”).

The term “mockup” well reveals the aim of these tools, that is, a very high flexibility so that they may be easily instrumented, the ability to simulate a broad variety of core configurations, and the ability to diverge easily during their subcritical approach. Another important feature of these tools is nuclear scientists’ and engineers’ training.

All the major countries involved in the nuclear field developed critical mockups during their flourishing years, for the reasons mentioned above. Yet, as it may be noted, many of them were shut down.

In contrast, France has distinguished itself by maintaining its three most multipurpose critical mockups in continuous operation for over 40 years.

Today, CEA’s experimental programs relating to critical mockups are conducted on these three mockups of very low power: ÉOLE, MINERVE and MASURCA, set up at Cadarache. The neutronic behavior of the cores investigated in these reactors can be directly extrapolated to the physical phenomena encountered in power reactors, by allowing for a representativeness factor. While being safe, these mockups are highly flexible, adaptable, easily accessed, and easy to instrument.

Operating experience feedback has shown the major importance of these tools, indeed, for improving nuclear competitiveness. Let us mention, for instance, the ÉPICURE Program in the late eighties which allowed the qualification of PWR core loading with 30 % MOX fuel, especially by validating the calculation of interfaces between mox and UOX assemblies. The CEA considers that these tools will still be necessary in the coming decades.

This paragraph details these three critical mockups and their operation, and illustrates what they bring in reactor physics.

The Water Critical Mockup ÉOLE

Objectives of the ÉOLE critical mockup, and facility description

The ÉOLE critical mockup is designed for neutronics studies of Light Water moderated lattices (Pressurized Water Reactors and Boiling Water Reactors) [1]. The reactor consists of a **hosting structure** including a **reactor block** fitted with a biological shielding and allowing operation up to a **neutron flux*** of $10^9 \text{ n.cm}^{-2}.\text{s}^{-1}$ in the core (fig. 39). Whereas the initial Decree creating the facility mentions a 10 kW power, today regulations limit operating power to 100 W (or 500 W on waiver request).



Fig. 39. The ÉOLE critical mockup. Overview of the reactor block.

The reactor is built around an aluminium vessel of about 2.3 m diam. and 3 m high, which was initially designed to receive the 12 tons of heavy water of the early experimental programs.

Since the ÉPICURE Program, another smaller-sized vessel (typically ~1.2 m diam. and 1 m high), called an “experimental vessel”, has been placed in the center of this vessel. A shell ring inside the experimental vessel can receive any type of water reactor core lattice thanks to a set of interchangeable grids (fig. 40). The shape and dimensions of this set of grids, as well as the experimental vessel, may be modified according to the needs of experimental programs.

Four safety rods located above the shell ring allow the reactor to be shut down at any time. The structure (plates or rods) as well as the position and composition of these rods vary

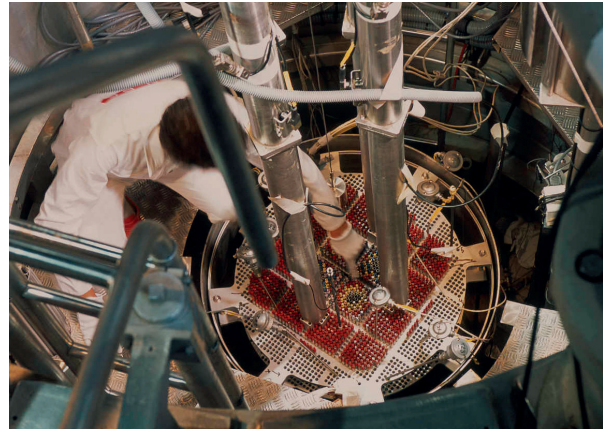

Fig. 40. The ÉOLE critical mockup: top view of an experimental core lattice (FUBILA experiment).

as a function of the cores investigated and of their built-in reactivity. The drop of these rods, with the help of a lancing system and by gravity, is extremely fast.

Criticality* is reached by adjusting the soluble boron concentration of the **moderator*** (light water) or by adjusting the number of fuel rods. These two parameters are said to be “critical parameters”. A regulating rod allows for **divergence*** and power stabilization between 0 W and 100 W.

A number of fuel types (MOX, PWR- and BWR-type UO_2 , MTR-type U_3Si_2) and absorbing materials, poisons or structural materials (natural and enriched B4C, AIC, Hf, UO_2 - Gd_2O_3 , pyrex, Zy-2, steel, etc.) can be used to reproduce lattices representative of industrial situations. The fuel rods are identical to those of core lattices used in power reactors, excepting for height (80 cm fissile core height).

Two temperature controllers, fitted on the water circuits that ensure filling, draining and boron supply to the moderator, allow moderator temperature to be fixed from 5 °C to 80 °C with a 0.1 °C accuracy in order to measure the **temperature coefficient***. These two temperature controllers also make it possible to design cores with two hydraulically independent areas.

In 1990, the instrumentation and control system of the reactor was fully upgraded so as to make it possible to get a neutron signal digital processing, use programmable controllers, and get screen display of the reactor states. In 2003 this

upgrading was completed by a refurbishing of the neutron control racks and of the supervisor.

Reaching the reactor’s critical state can be achieved through both the rise of the moderating solution (with water boricated or not) in the reactor vessel, until it can flow between the temperature control circuits at the desired temperature (by vessel / shell ring overflow), and the rise of safety rods.

Experimental techniques used in the ÉOLE mockup

Due to its flexibility, the ÉOLE critical mockup stands as an incomparable tool for light-water reactor physics, in that the experimental techniques used are adapted according to the neutron characteristics of the investigated cores.

Two main types of measurement can be distinguished, together with a high number of associated experimental techniques:

- The so-called “online” measurements, *i.e.*, chiefly, the follow-up of the fission chamber count rates (in a critical or subcritical state), and the quantities that can be deduced from it;
- Post-irradiation measurements, directly performed on fuel rods (**gamma spectrometry*** examinations, also called **gamma scanning***) or on detectors (**activation dosimeters*** or **thermoluminescent detectors***), following irradiation in the core (fig. 41).



Fig. 42. Fission chambers for measuring neutron flux in the ÉOLE critical mockup.

Neutron flux measurements by **fission chambers*** (fig. 42) split into two categories according to the integral quantity to be obtained:

- *Kinetics* measurements, *i.e.* essentially measuring the doubling time and absorber rod drops;
- *Quasi-static* measurements, in which the fission chamber count rate is analyzed to get information about the core criticality level or fission rate distributions, or the local spectrum in the core lattice.

Gamma spectrometry measurements (**gamma-scanning***) are post-irradiation, and provide information about the reaction rates generated in the core. The main rates measured are **fission*** (locally or along the paths) and **radiative capture***, through measurement of the total gamma activity of the fuel rod of interest or of specific isotopes (fission products or capture products). These measurements are complementary of the flux distribution measurements by fission chambers. The measurement by spectrometry of fissile or activation dosimeters irradiated in the reactor also helps complete such information by other types of reaction rates.

The irradiation of thermoluminescent detectors (TLDs) in the reactor, and then the reading of their luminescent emission through a thermal stimulation makes it possible to measure the gamma dose, an important physical parameter which completes neutron parameters.



Fig. 41. Post-irradiation measurement on a fuel rod issued from the ÉOLE critical mockup.

Experimental programs of the ÉOLE mockup

The French Decree of June 23, 1965 creating ÉOLE was signed by Georges POMPIDOU, Prime Minister, and Yvon BOURGES, Minister of State attached to the Prime Minister, with responsibility for scientific research and atomic and space issues. Two working years (1964-1965) will precede the first divergence, which was to take place on December 2, 1965.

After five years devoted to studying heavy-water core lattices, especially the CÉLESTIN lattices, the reactor was used as a safety test mockup (1972) with the CABRIOLE Program for CABRI, and the PHÉBÉE Program for PHÉBUS and SCARABÉE.

Then came programs for:

- Studying criticality: CRISTO I (1978) for broad-pitch PWR fuel storage lattices, completed by CRISTO II (1980), for investigating compact storage lattices;
- Studying the temperature coefficients of UOx and MOX fuels: CRÉOLE (1979), a program during which 200 MOX rods were placed in a pressurized loop (temperature of about 300°C under a 120 bar pressure);
- Qualifying computational schemes of neutron absorbers (hafnium, boron, gadolinium with various supports, ground or as grains) in PWR-UOx type cores (CAMÉLÉON Program in 1982);
- Studying closely-packed, undermoderated MOX lattices, for cores designed to be used as a ^{238}U - ^{239}Pu converter (ÉRASME Program in 1985).

The ÉOLE reactor was then used in a period devoted to investigating plutonium recycling in light-water reactors.

Four programs took place successively:

1989: the ÉPICURE Program, which aimed at qualifying the computational schemes of 30 % **MOX***- assembly loaded PWR cores. The program was to bring the accuracy of MOX lattice parameters to the same level as that of UOx lattices.

1995: the MISTRAL Program in support of Japanese and French studies relating to 100 % MOX loaded cores, the moderating ratio of which is increased with respect to that of standard PWRs;

2000: the BASALA Program, achieved in collaboration with the Japanese organization NUPEC and COGEMA, in support of the Japanese studies on 100 % MOX loaded cores of BWRs (assemblies with 9 x 9 rods);

2005: the FUBILA Program, in support of the validation of codes for the design of high-burnup, plutonium-recycling ABWR (Advanced Boiling Water Reactors). Improved representativeness with respect to the BASALA Program, thanks to the use of BWR-geometry rods and higher plutonium contents.

ÉOLE's recent operating period encompasses programs for supporting industrial reactors or the future Jules Horowitz irradiation reactor:

2004: the ADAPh Program for qualifying the HORUS-3D-P tool designed to calculate the photon-induced heating of the Jules Horowitz Reactor devices;

2006: the FLUOLE Program, designed to provide a qualification basis for the computational tools applied to the PWR-1300 vessel **fluence***;

2007: the PERLE Program for studying the steel-made heavy reflector of Generation III PWRs.

2009-2011: the AMMON Program for qualifying the HORUS-3D tool used for the design and safety studies of the Jules Horowitz Reactor.

The experimental program FLUOLE in ÉOLE

Extended operation of nuclear reactors is based on various factors, such as the maximum expected lifetime of the facility's unreplaceable components, that is the vessel and the containment. With this prospect, the CEA develops computational tools to predict the fluence to the vessel, using the TRIPOLI-4 code and the associated libraries ENDF/B et JEFF.

The FLUOLE experiment (FLUOLE being an acronym of the French phrase FLUence dans éOLE) is designed to produce an experimental basis for qualifying CEA and EDF computational tools applied to **neutron fluence** in a core configuration representative of the water-steel laminates to be encountered in the 1300 MWe reactors of the **French nuclear fleet**. The critical configuration of the FLUOLE core was obtained in November 2006, and the irradiations were completed in June 2007.

The general scheme of the experiment FLUOLE conducted in ÉOLE is based on a square lattice of 29 x 29 PWR-type fuel rods (3.7 % ^{235}U enriched UO_2), which have a Zy-4 alloy clad and are placed under AG3 twofold clad in order to get a moderating ratio representative of PWRs under hot operating conditions.

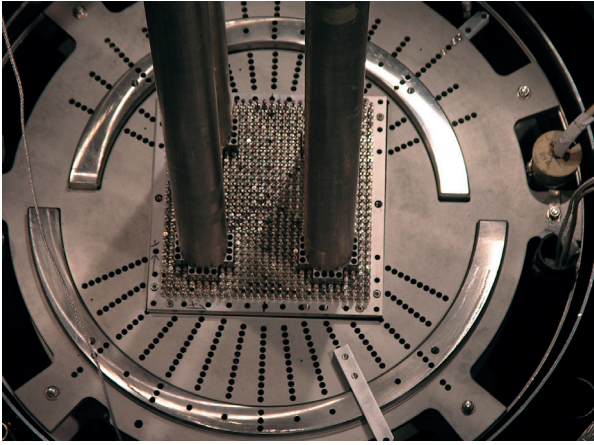

Fig. 43. Top view of the FLUOLE experiment in the ÉOLE critical mockup.

The water-steel laminates to be encountered in PWRs between the core and the vessel (baffle assembly, core barrel and thermal shield assembly) are simulated by a stainless steel plate 22.2 mm thick (identical to that of PWRs), which consists of two stainless-steel, half-cylinder shaped parts, one of them with a different radius (fig. 43 and 44).

One of the features of this experiment is the possibility to simulate several azimuths around the core, and get accurate measures for several neutron energy levels using a specific instrumentation as a function of water and steel thicknesses. These measures are obtained with fission chambers and through activation dosimetry. A special focus is given on the latter so as to get a maximum of information on the neutron spectrum and its deformation in water-steel laminates.

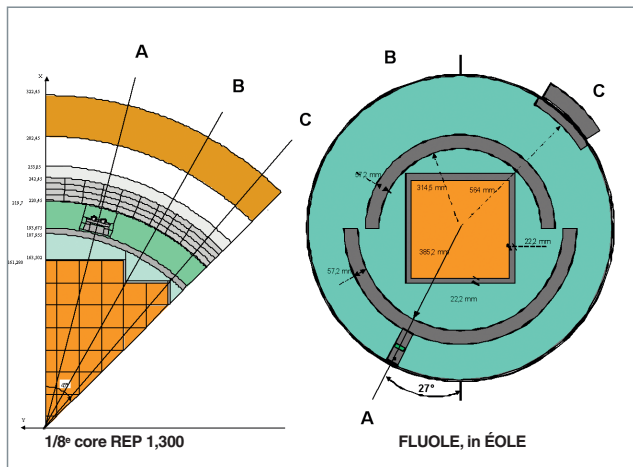

Fig. 44. The FLUOLE experiment. Diagram of core and reflector geometry.

A collaboration with a CNRS/IN2P3 laboratory (Grenoble), specialized in measuring very low activities, has corroborated the results obtained by dosimetry in these highly attenuated neutron fields. In addition, the measures obtained by gamma spectrometry on ÉOLE rods have made it possible to achieve a fine characterization of the sources required for calculations, and to take part in the validation of the PWR core computational schemes with a representative baffle assembly.

The measurements have been specifically dedicated to determining the flux using activation detectors such as In-115 (fast flux > 1.3 MeV), Zn-64 (fast flux > 2.8 MeV), Al-27 (fast flux > 7.3 MeV), Au-197 and Mn-55 (**thermal*** and **epithermal*** flux). The reaction rates have been determined on representative paths in all the core materials (fuel, reflector, baffle assembly, core barrel, thermal shield). Miniature fission chambers have also been used, which give access to the fission rate of specific isotopes (e.g. Np 237 – epithermal flux; ²³⁵U – thermal flux).

The experiment objectives regarding dosimetry have been reached with over 810 measures, including the component simulating the vessel and the monitoring capsule holder.

The experimental program PERLE in ÉOLE

Till now, the whole of the experimental programs conducted at the CEA and, particularly, on ÉOLE has only been implemented on cores fitted with a peripheral moderator (a reflector in water, either boricated or not).

Design studies of Generation III PWRs implement a stainless-steel thick reflector, generally named “heavy reflector”, instead of the standard baffle assembly and the water located between the baffle and the core barrel, in order to improve fast neutron reflection and limit the fluence to the vessel.

The PERLE Program (PERLE: *Programme d’Étude de Réflecteur Lourd dans ÉOLE*, Program for investigating heavy reflector in ÉOLE) is designed to qualify the computational tools used for this type of reactor, and especially for assessing computational mistakes related with the occurrence of the steel reflector.

In order to preserve some coherence with the FLUOLE program, it has seemed interesting to define the lattice on a common basis (pitch, overclad size). Thus, the lattice introduced into ÉOLE is a square lattice of 27×27 (instead of the 29 × 29 in the FLUOLE Program) PWR-type cells containing 3.7 % ²³⁵U enriched UO₂ fuel rods, which have a Zy-4 alloy clad and an AG3 twofold clad in order to get a moderating ratio representative of PWRs in hot operating conditions (fig. 45 and 46).

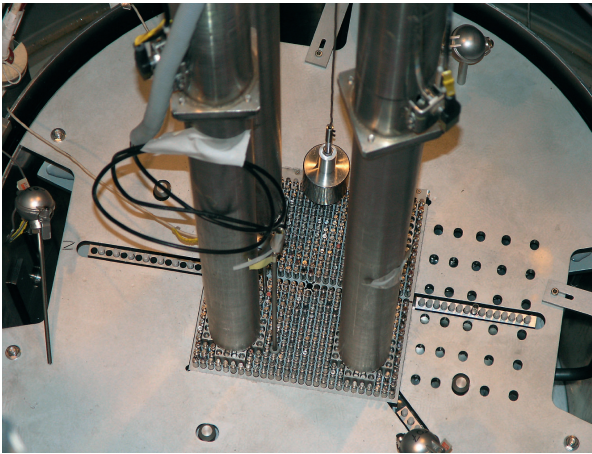

Fig. 45. The PERLE program in ÉOLE. Top view – outer part of core arrangement.

The program is achieved in two phases:

- A first phase, characterized by a PWR rectilinear lattice core with a homogeneous steel reflector, consists in qualifying the calculations relating to the reflector gain, the core/reflector interface, the neutron flux at intermediate energies in the reflector, and the gamma-induced internal heating in steel. It also makes it possible to reduce uncertainties on nuclear data;
- The second phase takes into account, on one side of the core, the presence of water cooling channels in the heavy reflector. The purpose here is direct measurement of the neutron parameters altered by the presence of these water channels, which locally produce an overmoderation prejudicial to the reflector gain.

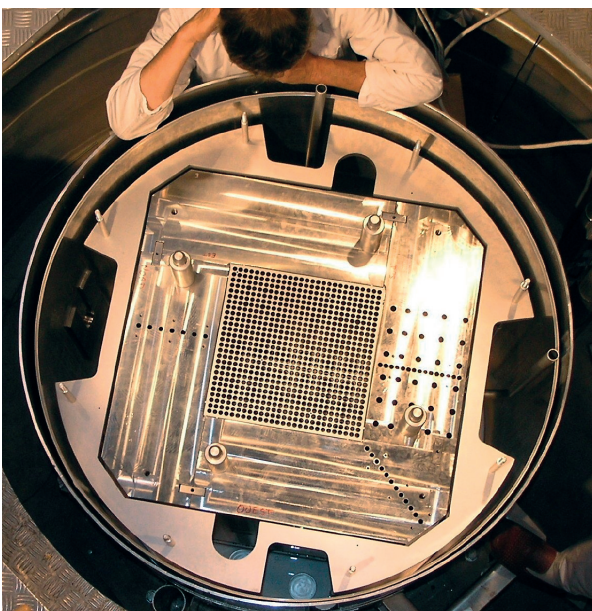

Fig. 46. The PERLE program in ÉOLE. Top view – inner part of core arrangement.

Experimental measures obtained between August 2007 and February 2009 have been related with:

- A full characterization of neutron flux distribution in the core, through gamma spectrometry measurements on fuel rods;
- Neutron flux paths through fission chambers of various thresholds and through irradiation of activation dosimeters, in the fuel lattice as well as in the reflector (two radial paths and one diagonal);
- Gamma dose measurements in the reflector, obtained through irradiation of thermoluminescent detectors.

The CRÉOLE experimental program made perennial in the international base IRPHE

The experimental program CRÉOLE, conducted in the ÉOLE reactor in the 1978-1981 period, aims at providing accurate differential information on the PWR **temperature coefficient*** between 20°C and 300°C [3].

The experimental device consists of a central test loop, in which it is possible to achieve the operating conditions of a PWR power reactor (300 °C and 120 bars), an empty separation zone, and a driver core of variable size, surrounded by a water reflector.

The isothermal temperature coefficient of the UO_x and MOX lattices was measured from 20 °C to 300 °C in the pressurized central loop using the **doubling time*** method. Moreover, the integral reactivity effect relating to the 20 °C-300 °C variation in temperature was obtained, first, through a variation in critical size, and, second, through a soluble-boron equivalent poisoning in the loop.

Radial distributions of fission rates have been measured by direct gamma spectrometry on the fuel rods, and axial flux maps were achieved using fission chambers.

Measurements were performed in four experimental configurations of the central loop, with 200 fuel rod emplacements in a 1.26 cm pitch, typical of 17 × 17 PWR assemblies:

- A “clean” UO₂ lattice (200 3.1 % ²³⁵U enriched fuel rods);
- A UO₂ lattice “poisoned with 1166 ppm boron in water” (200 3.1 % enriched fuel rods);
- A “clean” MOX lattice (80 3.2 % Pu content fuel rods and 120 2 % Pu content fuel rods);
- A “water-hole, clean” MOX lattice (72 3.2 % Pu content fuel rods, 108 2 % Pu content fuel rods with 20 water holes).

Five additional configurations have been obtained using aluminium overlads in order to simulate variations in water density.

Measures collected in the CRÉOLE Program have dealt with:

- Operating conditions: temperature, pressure and boron quality;
- Basic technological parameters: materials geometry and compositions;
- Parameters characterizing the critical state at room temperature;
- Temperature coefficients;
- Reactivity worth of soluble boron as a function of temperature;
- Distributions of reaction rates.

This experiment was submitted to the NEA Databank, and is now made perennial as a “benchmark” in the International Base of Reactor Physics Experiments IRPHE.

**Gilles BIGNAN, Jean-Christophe BOSQ, Philippe FOUGERAS,
Daniel BERETZ and Jean-Christophe KLEIN**
Reactor Research Department

► References

- [1] P. FOUGERAS, J.-P. HUDEOT, D. RIPPERT, F. MELLIER, P. BLAISE, M. ANTONY and N. HUOT, “*The place of ÉOLE, MINERVE and MASURCA facilities in the R&D and training Activities of the CEA*”, PHYTRA1 : *First International Conference on Physics and Technology of Reactors and Applications*. Marrakech (Maroc), 14-16 March 2007.
- [2] D. BERETZ, S. BOURGANEL, P. BLAISE, C. DESTOUCHES, N. HUOT, J.-M. GIRARD, C. DOMERGUE and H. PHILIBERT, “*FLUOLE: A new relevant experiment for PWR pressure vessel surveillance*”, ISRD : *International Symposium on Reactor Dosimetry*. Alkmaar (Pays-Bas), 25-30 May 2008.
- [3] M. DARROUZET, C. GOLINELLI, L. ERRADI, J. CRAY, J. DUFOUR and A. SANTAMARINA, “*CRÉOLE Experiment, measurements of moderator temperature coefficient in UO_2 and UO_2 - PuO_2 lattices*”, EURATOM Report COM 4053 EN, 1983.

MASURCA: an Air Critical Mockup Dedicated to Fast Neutron Reactor Study

With ÉOLE and MINERVE, the MASURCA reactor constitutes one of the “zero power” critical mockups operated by the CEA on the Cadarache site. Built between 1964 and 1965 (fig. 47) within the framework of the “Fast Neutrons” joint agreement signed in 1962 between EURATOM and the CEA, this reactor first diverged on 14 December 1966. It was licensed to operate at a maximum neutron power of 5 kW in 1969 and, since then, has been mainly used to study **fast neutron*** reactors.

MASURCA objectives and facility description

As mentioned in a publication issued in 1963 [1], “MASURCA is mainly designed to carry out neutron experimental studies on big-sized, non-moderated, zero-power critical cores using plutonium as fuel.

The first purpose of these experiments is to provide experimental data for the validation and qualification of neutron computer codes, as well as for the improvement of related nuclear data libraries. These experiments may be of analytic/parametric type, or of “mock-up” type, i.e. representative of a whole core or of a specific situation reproduced as faithfully as possible (in terms of geometry, dimensions and compositions of the various constitutive media). The abilities of this facility (designed with a purpose of flexibility and in search for maximum safety) and its huge stock of materials (**fissile***, **fertile***



Fig. 48. Top view of the MASURCA critical mockup.

and inert) allow a broad range of different experiments and core configurations to be achieved.

The MASURCA area and the reactor building

The MASURCA facility is located on the Cadarache Center, and constitutes the INB 39 (INB: *Installation Nucléaire de Base*, regulated nuclear facility). It contains a 6,000 m² platform included in a zone of a total surface area of about 3 hectares, surrounded by a double gate (fig. 48). The INB 39/MASURCA consists of four main buildings, interconnected by underground galleries or surface-covered pathways: the Reactor Building, the Control and Instrumentation Building (which contains control and monitoring devices, and reactor control and measuring rooms), the Storage and Handling Building, and the Auxiliary Building, which shelters workshops as well as part of containment and core ventilation systems.

The reactor building, partly buried, has a total height of about 25 meters. Consisting of a metal shell ring of 18 m diam., capped with a dome, it includes the reactor core, supported by bulky internal structures of reinforced concrete which are also used as a biological shielding, the main experimental equipment, a vertical assembly storage zone, as well as the various handling means allowing these assemblies to be loaded or unloaded in the reactor core (fig. 49).



Fig. 47. Construction of the MASURCA reactor.

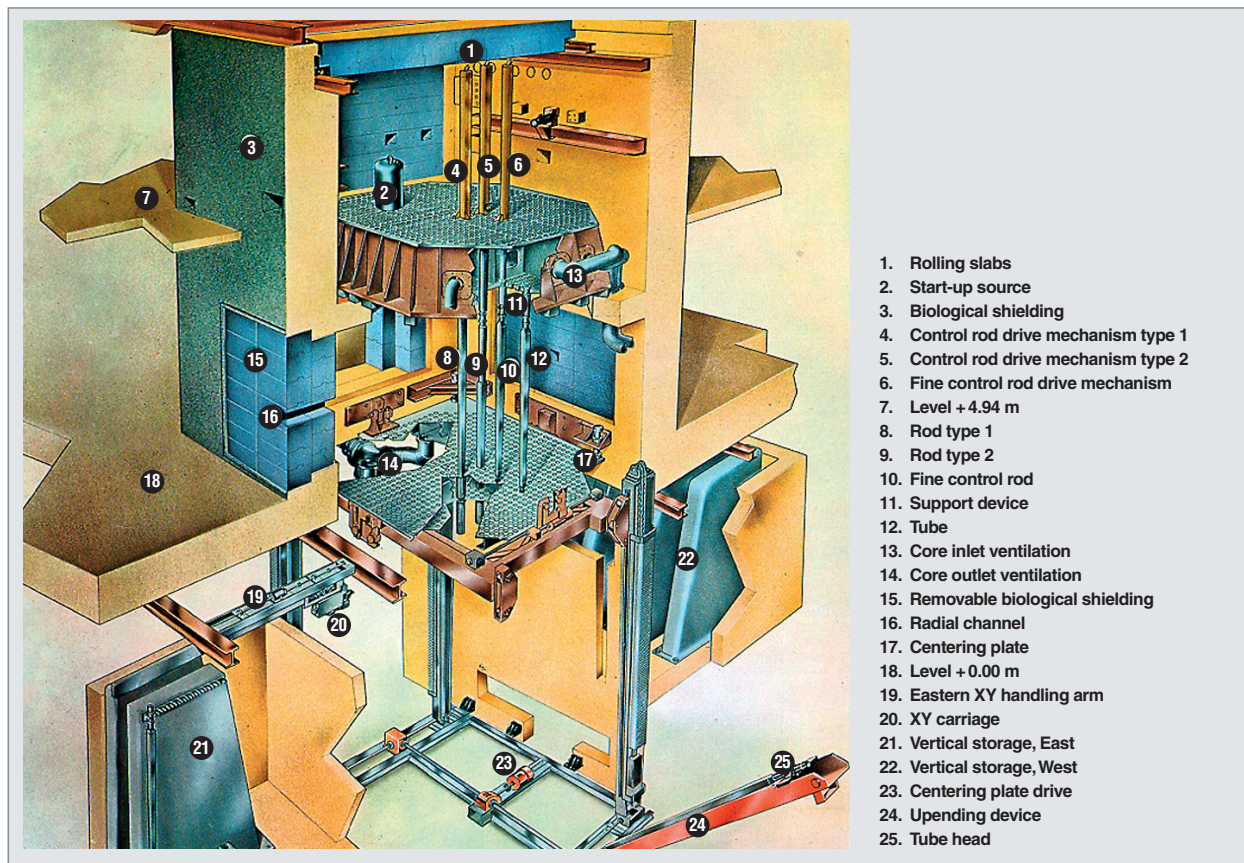

Fig. 49. The system for handling MASURCA fuel assemblies.

Core configuration

Each core put in MASURCA consists of a lattice of stainless-steel assemblies known as “loading tubes”, dismantlable, loaded with elements simulating the constitutive materials of the cores to be studied in the Storage and Handling Building, and fixed in their upper part to a parallelepipedic box using appropriate handling equipment (fig. 50).

In practice, two main types of tubes are used (fig. 51):

- The MASURCA tube, designed to house simulation elements as rodlets and blocks. It consists of two half-envelopes made of a stainless steel sheet 105 mm wide and 3.80 m long as a whole (including the tube head and foot);
- The 4/4 tube consisting of 4 head- and foot- connected tubes 2 inch wide, to reproduce an overall geometry similar to that of the MASURCA tubes. Using these tubes allows better flexibility when several basic patterns have to be placed in the same tube.

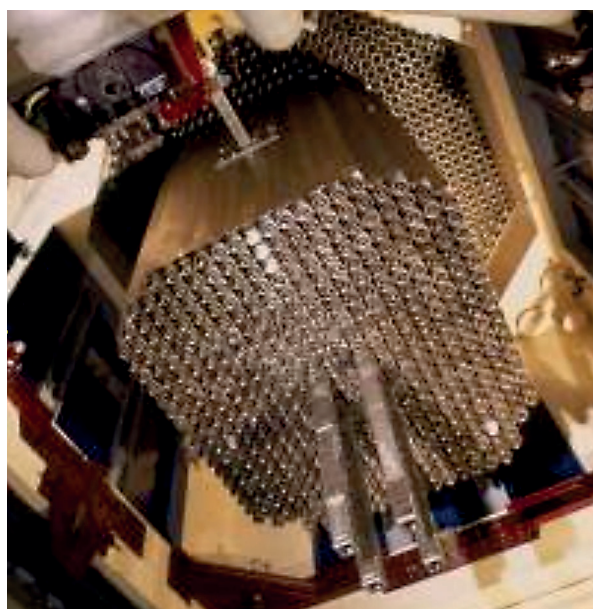

Fig. 50. Top view of MASURCA core as it is being mounted.



Fig. 51. Mounting of one of MASURCA assemblies in the Storage and Handling Building.

Simulation materials

Simulation elements (fissile, fertile, reflector, inert or absorber materials) take the form of:

- Square or circular-section rodlets 1/2 inch wide or diam., and 4-24 inch high (fig. 52);
- Square-based platelets 2 inch wide and of variable length (1.5 to 6 mm);
- Square-based blocks 2 or 4 inch wide and, most often, 4.8 or 12 inch long.

These components are gathered so as to constitute basic patterns which are reproduced inside the tubes. These basic patterns (cells) make it possible to simulate the characteristics of



Fig. 52. Simulation element rodlets for the MASURCA core.

the cores to be investigated (volume percent of various materials, enrichment).

The list of nuclear materials presently available at MASURCA includes: thorium oxide, metallic uranium up to 35 % ^{235}U , uranium oxides (depleted and enriched up to 30 % ^{235}U), metallic plutonium, plutonium oxide, and uranium/plutonium mixed oxides with 240 Pu contents varying from 8 to 44 %. Several types of inert materials (sodium, steel, graphite, lead) are also used to simulate the coolant, the reflector and structural materials. The available quantities allow cores to be achieved with different volumes of fissile zone: the smallest core loaded in MASURCA accounted for a 140 liter volume against 3,400 liters for the biggest core (to be compared with the 1,500 liters of the PHÉNIX core volume).

Control and safety systems

The control and safety members coupled with the core are as follows:

- The safety rods, which ensure reactor safety during operation and handling;
- The fine control rod (or regulating rod), which is used for reactor control.

The number of safety rods depends on the features and size of the cores, but a minimum of four is required. These rods are special tubes consisting of one part of square section, to be loaded just as a fuel tube (or reflector), overhauled by a cylindrical element containing the absorber materials modules (boron carbide rodlets and/or blocks). These rods are connected with a mechanism fitted on the support device, which allows the rod to be moved and dropped by gravity (fig. 53). In normal operation, these rods are emplaced axially so that their fissile part be exactly in front of the fissile stacks of the other fuel tubes. The absorber part is then fully extracted, and has no influence on the core fuel zone.

The so-called “fine control rod” allows the reactor to be made critical, and the power to be tailored to the level required for experiments. There again, the selected design aims at minimizing the perturbations induced by this device. The rod consists of a mobile part, of limited volume, inserted into a tube made out of materials similar to those of the neighboring tubes. The mobile part consists of a fissile rodlet stack surrounded of steel in the upper part, and of moderating material in the lower part. A change is induced in the neutron balance through progressively introducing moderating blocks into the fissile material of the fine control rod, and criticality can so be reached.

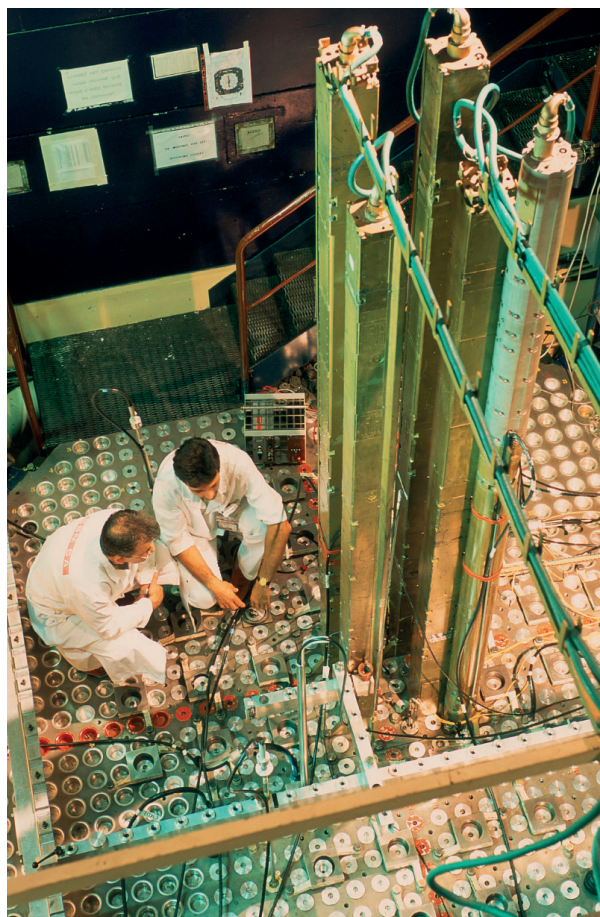

Fig. 53. View of the core support device and of the safety rod drives in MASURCA.

In order to fulfill the objective of not moderating neutrons coming from the core, the tubes are cooled with air. In particular, the coupled system makes it possible to ensure, in each tube containing fissile material, a sufficient air flow rate to help remove the released power, to control the air so as not to upset physical measuring, and to ensure safety for the facility, staff and environment by detecting and filtering a possible radioactive contamination. The inlet temperature of the core ventilation circuit can be adjusted between 20 °C and 35 °C. The total flow rate can also be adjusted.

Measuring tools

The authorized maximum neutron power is 5 kW. Depending on cores, the maximum total **neutron flux*** at the center of the core then fluctuates between a few 10^{10} n.cm⁻².s⁻¹ and 10^{11} n.cm⁻².s⁻¹. These values are sufficiently high for accurate measures to be performed in reasonable acquisition times (counting statistics).

There exists a high number of measuring devices, which can be designed on demand depending on needs. Two radial perpendicular channels, and as many axial channels as required (1 per tube) can so be arranged in the core. The size of these

channels is generally equivalent to a square rodlet 1/2 inch wide (1.27 cm). Radial channels of larger size can be arranged, similar to those emplaced as part of the RACINE (IRMA configuration) and MUSE-4 programs.

They make it possible to introduce and move through the core fission chambers, fissile or non-fissile dosimeters, neutrons sources, as well as thermoluminescent detectors and ionization chambers for measuring gamma-induced heating. *In fine*, these channels give access to the space distributions of reaction rates, which are data of particular interest for the teams in charge of validating and qualifying computational systems for neutronics.

In addition, a number of counters and thermocouples can be distributed among the various core zones. These devices are used for redundant follow-up of measurements, and strengthen the analysis of the phenomena investigated during experiments.

MASURCA experimental programs

After an early operational phase devoted to quantifying the facility performance and developing the first experimental techniques for measuring (1967-1969), three major periods can be identified for experimental programs:

- A first step (1969-1994) of support to the development of sodium-cooled fast neutron reactors (RAPSODIE, PHÉNIX, SUPERPHÉNIX);
- A second step (1994-2000) devoted to actinide burning studies in this type of reactor (“plutonium burner” cores);
- A last step (2000-2006) devoted to studying the behavior of fast-spectrum cores of subcritical reactors (of type **ADS***: Accelerator Driven System).

First stage: supporting the development of the fast neutron reactor system (1969-1994)

Once the MASURCA reactor fully characterized, and as a function of fissile materials availability, the programs have focused on basic studies in support to the PHÉNIX reactor, which started up in 1973, and of the SUPERPHÉNIX reactor, which started up in 1985.

Until the mid-seventies, experiments consisted in basic parametric studies on homogeneous cores. The main parameters changed during experiments were the nature of simulated fuel (metal or oxide of uranium or uranium/plutonium), the height/diameter ratio of fuel zone, the fissile material content, and the characteristics of **fertile blankets*** (depleted uranium, uranium oxide, steel/sodium). The first studies led to developing and qualifying a neutronics computational form

(called CARNAVAL) for fast spectrum lattices, to be used for the design basis of high Pu content fast reactor cores, with a zoning of this content.

As an illustration, it is worth to mention the PLUTO Program, implemented basing on the availability of three different UO_2 and PuO_2 fuels, with 8 %, 18 % and 44 % ^{240}Pu , which aimed at improving knowledge about higher isotopes of plutonium, and from which a new standard version of the computational form (CARNAVAL IV) could be drawn.

Experiments conducted in support of SUPERPHÉNIX startup have been then dedicated to the neutronics study of axial heterogeneous cores (in which fertile assemblies are inserted into the fissile zone in order to improve the **breeding gain*** and the **doubling time***). Relatively simple core geometries have been selected, in which the fertile ring thickness and position (*i.e.* the typical parameters of the heterogeneous concept) vary almost systematically (fig. 54).

Many measurements of the sodium **void effect*** (a key parameter for fast reactor safety) have also been achieved, together with the simulation of the loading pattern relating to the subcritical approach adopted for SUPERPHÉNIX.

After SUPERPHÉNIX startup, programs have been pursued with multiple objectives such as:

- Reducing the uncertainty on predicted loss of reactivity due to heavy nuclei;
- Improving the tools used for computing gamma internal heating and energy deposition in absorbers;
- Getting further information about heterogeneity effects due to the geometric array of **absorbers*** in the control rod assembly.

Second stage: “plutonium-burning” cores (1994-2000)

According to the new orientations defined by the French 1991 Act on long-lived radioactive waste management, a research program named **CIRANO** started in 1994, which aimed at investigating plutonium-burner cores. The first part was devoted to the replacement of fertile blankets by steel/sodium reflectors. The second part of this program investigated the features relating to in-vessel fuel storage (including the effect of an absorber tube row between the core and this storage area). The last part of the program implied loading tubes with a high (25 to 48 %) plutonium content and various isotope compositions of plutonium in the central zone (8-33 % ^{240}Pu content). The broad experimental basis obtained extends the qualification area of the ERANOS code, a CEA’s new reference code for fast neutron reactor neutronics, which has become a world standard (used by India, China, the United States...).

Still in support to the French 1991 Act’s demands, the **COSMO** Program was initiated in the late nineties to study the reactor physics topics relating to long-lived FPs **transmutation*** in **targets*** moderated in fast neutron reactors. In the first part of this program, a moderated assembly consisting of a sodium zone surrounded with $^{11}\text{B}_4\text{C}$ pins is placed in the core center. In the second part, the moderated assembly is moved to the core/reflector interface. In the last part, the effects of various moderators $^{11}\text{B}_4\text{C}$, CaH_2 , and ZrH_2 were investigated. For these configurations, measurements of **fission rates*** and **neutron spectrum*** have been performed at the center of, and on contact with, moderated assemblies. These experiments helped design the irradiation experiments ÉCRIX in the PHÉNIX reactor (that took place in 2003, and allowed significant advances in the field of transmutation).

Third stage: neutronics of subcritical systems (2000-2006)

As part of studies on long-lived FPs transmutation in subcritical systems, called “hybrid” as they couple a reactor and an accelerator (Accelerator Driven Systems - **ADS*** -), the **MUSE** Program (*Multiplication par Source Externe*) is aimed at study-

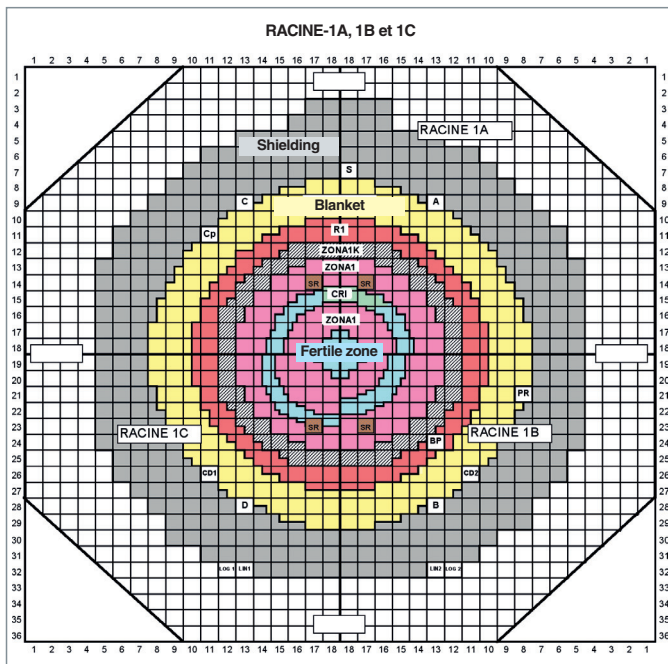

Fig. 54. Scheme of the RACINE experiment in MASURCA for studying radially heterogeneous fast neutron reactor cores. The various core areas stand for fissile and fertile areas arranged according to rings of various thicknesses in the three RACINE 1 experiments (A, B, C).

ing the physics of these concepts, and the control of their reactivity, a key issue indeed. Following a preliminary study period, experiments have continued within a European framework, as MASURCA has become the standard tool for investigating subcritical system physics (see the inset below).

Many MASURCA-related programs have initiated international collaborations, e.g. with the Italian National Agency for Atomic Energy (ENEA⁵), the Karlsruhe Research Center (FZK), the Argonne Laboratory (ANL), the Belgian Nuclear Research Center (SCK-CEN)..., as well as benchmarks, in order to compare various experimental techniques and analytical methods

5. ENEA: an Italian acronym for *Ente Nazionale per l'Energia Atomica*.

(fission and capture rate measurement, reactivity weight of control rod assemblies, measurement of the delayed neutron fraction).

Alain ZAETTA and Frédéric MELLIER
Reactor Research Department

► References

- [1] A.P. SCHMITT, F. STORRER, G. VEDRYES, G. TAVERNIER and J. VAN DIEVOET, "MASURCA. Maquettes critiques à neutrons rapides. Description fonctionnelle et objectifs", *Proceedings of the symposium on exponential and critical experiments held by the I.A.E.A.* in Amsterdam, The Netherlands, 2-6 September 1963, vol. 1, pp. 135-155.
- [2] *Global results from deterministic and stochastic analysis of the MUSE-4 experiments on the neutronics of accelerator - driven systems - Nuclear Science Engineering*, vol. 158, pp. 49-67 (2008).

The MUSE-4 program (2000-2004)

The MUSE experiments conducted in the MASURCA reactor (Cadarache Center) constitute a fundamental step in understanding the behavior of a **subcritical*** multiplying medium driven by an external neutron source (**ADS***, i.e. Accelerator Driven System, which is being studied as the most potentially interesting system for transmuting some actinides).

These experiments are conducted in a reactor in which power is very low (<5 kW) and temperature effects are negligible. They are based on the use of an external neutron source, well known in terms of intensity and neutron spectrum, which allows the experimental validation of the subcritical medium to be dealt with separately from the experimental validation of the external source features.

On the basis of the preliminary experiments MUSE-1 and, then, MUSE-2, conducted with the help of a californium 252 source placed at the center of the core, it could be checked that the experimental techniques implemented in **critical cores*** could also be used in subcritical configurations. Later on, MUSE-3 experiments constituted the first significant parametric study with the implementation of several configurations displaying increasing subcriticality levels. Based, in this very case, on the use of a common neutron generator put, this time again, at the center of the core, these experiments have above all contributed to determine the characteristics of a future neutron source, more intense and better adapted to the experiments under consideration. This intense source was implemented in the MUSE-4 experiment, which took place within the framework of a broad international collaboration gathering 15 organizations of 12 different countries.

The objectives were the following: 1) controlling a subcritical fast core with an external neutron source simulating the **spallation source*** of an ADS, 2) characterizing such a system so as to provide experimental data for the validation of neutronics computational tools, and 3) investigating the analytical techniques and methods for monitoring and online follow-up of the subcritical core reactivity.

All the configurations, representative of a fast neutron burner core, were loaded with MOX fuel and sodium as coolant. The core was axially and radially surrounded with a reflector made of sodium and steel. The simulation of a spallation target and the neutron source (i.e. the neutron generator GENEPI) consisted in a 250-keV deuteron horizontal beam sent onto a deuterium or tritium titanium target (TiD or TiT) located at the center of the core and surrounded with a lead buffer zone.

The experiment has shown that the reactivity level of an ADS may be calibrated with an accuracy of about 10 % (with a **multiplication factor*** k_{eff} of 0.95) and that the ratio "accelerator current over core power" constitutes a simple indicator for online follow-up of reactivity.

See for example the two figures 9a and b below which display the experimental results and the related calculations for the accurate measuring of fission rates on a radial path of the core for thermal neutrons and fast neutrons as part of the MUSE program. They show the very good level of validation of core computational tools developed at the CEA for fast spectrum lattices.

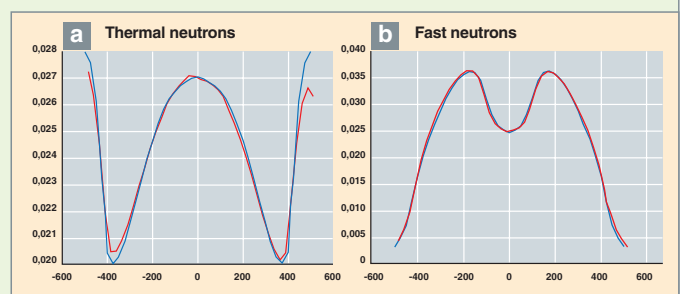

Fig. 55. Radial path of fission rates measured for thermal and fast neutrons (red = measure, blue = calculation)

The Water Critical Mockup MINERVE

Objectives of the MINERVE reactor and facility description

The MINERVE reactor is designed for neutronic studies of fuel lattices in various nuclear reactor systems, mainly to improve the knowledge of basic nuclear data. It is also used as a support to teaching and training activities (training of future reactor operators, practical work for students attending the Atomic Engineering course...) [1].

The reactor is built in a 120 m³ stainless-steel, parallelepipedic pool. The moderator is demineralized, ordinary water, purified on filters and ion exchanger resins. The cooling of the core immersed under 3 meters of water is ensured by natural convection. The maximum power is 100 watts, which accounts for a thermal flux of 10⁹ n.cm⁻².s⁻¹.

The core is divided into two zones (fig. 56):

- A driver zone, surrounded by a graphite reflector, which consists of MTR type assemblies of aluminium/uranium alloy plates (put into aluminium clads, and gathered into elements, each of them containing 9, 12 or 18 plates);
- A measuring zone, which houses various types of experimental lattices introduced into a square cavity 70 cm wide, placed in the center of the driver zone. This experimental zone is used to reproduce neutron spectra characteristic of various nuclear reactor systems.

Control is ensured by four identical control and safety rods consisting of two stainless steel-clad, natural hafnium plates, which slide through the center of a 12-plate fuel element. The rods are coupled to the control rod drive mechanisms by electromagnets, which allows for gravity drop. The reactor control room and the whole of the I&C system, using SIREX racks, have been upgraded in 2002.

The main assets of the MINERVE reactor lie in the following features:

- **The accuracy of the measures** obtained through the oscillation technique in order to determine the reactivity weight of samples containing the materials investigated (see the inset below, p. 63);
- **Flexibility in terms of neutron spectra:** for it is possible, indeed, to encompass the whole range of

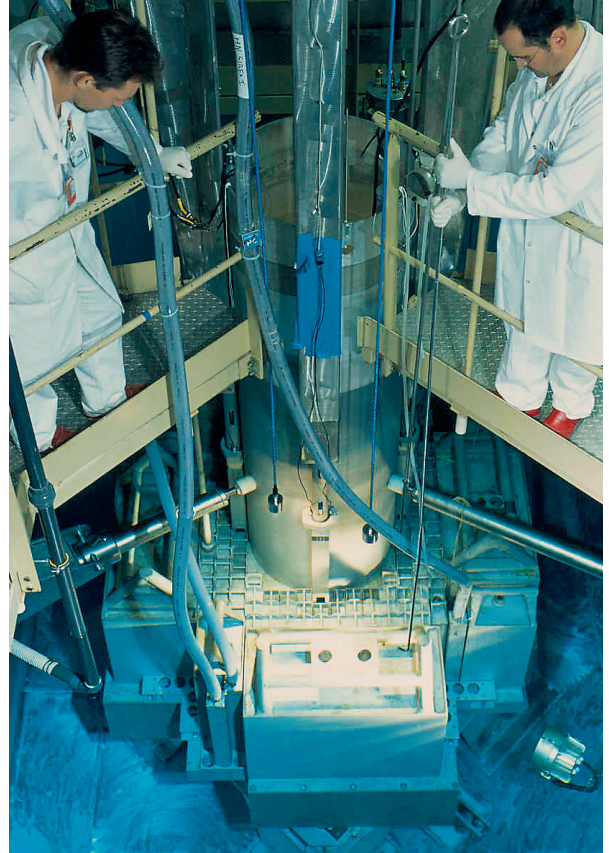

Fig. 56. Topview of the MINERVE reactor. The measurement area and the driver core can be respectively seen in the center and on the periphery.

neutron spectra, from a highly thermalized spectrum representative of a spent fuel treatment line **dissolver***, to a fast spectrum, including PWR, PWR-MOX, BWR, or **epithermal*** type spectra;

Table 9

Assembly	Experimental lattices	Neutron spectrum
MÉLODIE	R1-UO ₂	PWR UO ₂ spectrum
MÉLODIE	R1-MOX	PWR MOX spectrum
MÉLODIE	R2-UO ₂	Dissolver spectrum
MÉLODIE	REB	BWR spectrum
CARMEN*	CARMEN	Epithermal spectrum
ERMINE	ERMINE	Fast spectrum

* Assembly under design.

- **low cost of experiments**

experiments are generally achieved in core configurations already existing, or not requiring fresh fuel supply, hence a decrease in experiment cost. The main cost originates in the making of oscillation samples, which contain small amounts of materials, and are therefore relatively cheap. These small amounts to be involved often make experiment feasibility easier, considering the scarcity of some materials, and make it possible to get comprehensive, selective information in relation to the isotopes under investigation.

The coupled assemblies of the MINERVE mockup

The MÉLODIE assembly is a cylinder of 71.2 cm diam. (fig. 57). The center of the internal structure MÉLODIE consists of an upper and a lower aluminium grid plate drilled with 801 holes forming a lattice with a square pitch of 1.26 cm, and connected with aluminium tubes used as fuel overclads. This zone forms a cylinder of about 40 cm diam., whose fuel loading may vary according to the neutron spectrum of interest:

- The MÉLODIE R1- UO₂ lattice, representative of UO₂-PWRs, which includes 776 cells containing one 3 % ²³⁵U enriched UO₂ rod, 24 cells put in the lattice peripheral part and containing aluminium rods, and the central cell, which houses the oscillation cane,
- The MÉLODIE R1-MOX lattice, representative of MOX-PWRs, which includes 124 central cells containing 4 % Pu enriched UO₂-PuO₂ rods, 28 cells, on the periphery of the latter, containing 3.6 % Pu enriched UO₂-PuO₂ rods positioned near the angles, and the central cell, which houses the oscillation cane;
- The MÉLODIE R2-UO₂ lattice, representative of a dissolver, which is identical to the R1-UO₂ configuration, except for a central water hole of 3 x 3 cells, with which the highly thermalized spectrum of interest can be obtained in the oscillation channel;
- The MÉLODIE REB lattice, representative of a Boiling Water Reactor (BWR), which is identical to R2-UO₂, except for its center consisting of an aluminium block 11.34 cm wide (*i.e.* the equivalent of 9 cells), and drilled with a channel of 15.5 mm diam. in its center.

A new assembly, under design, will be introduced into the MINERVE reactor in 2011. This CARMEN lattice will be dedicated to studies on undermoderated lattices.

The ERMINE assembly was an experimental lattice likely to house several experimental lattices representative of fast spectra. Today, that lattice is no longer available.

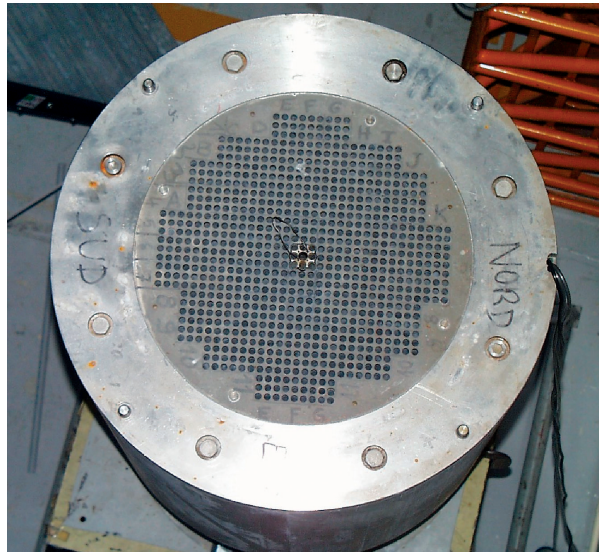

Fig. 57. Measuring area of the MINERVE critical mockup fitted with the MÉLODIE assembly.

Experimental programs of the MINERVE mockup

The MINERVE reactor diverged on September 29, 1959 at CEA/Fontenay-aux-Roses.

MINERVE was chiefly used to measure thermal **cross sections*** and **resonance integrals***, and for studying plutonium recycling in natural uranium reactor systems.

In **1966** was achieved the first thermal-fast critical assembly of the ERMINE (*Expérience Rapide MINerve*) series, which included a driver zone, a transition zone and an experimental zone. MINERVE was then dedicated to studies for the fast neutron reactor system, in which fairly subcritical volumes of various fast neutron multiplying lattices (ERMINE 1 to 3) were placed in the central cavity of MINERVE.

Since November **1971**, ERMINE 4 and ERMINE 5, “fast” cores and MÉLODIE (light water) cores have alternately been achieved: hence the first qualification of light water fuel lattices, and then the qualification of the 17 x 17 PWR lattice.

On **30 April 1976**, the MINERVE reactor was operated for the last time at Fontenay-aux-Roses. Its transfer and rebuilding at Cadarache were performed in 1976 and 1977, as part of decentralization measures aiming to gather most of CEA’s critical experiments outside the Paris area.

In September **1977**, light-water and fast neutron configurations started again, alternately, in MINERVE: hence the first qualification of gadolinium **burnable poisons***, and the EURATOM Program on plutonium recycling in PWRs.

Oscillation technique in the MINERVE reactor

The experimental oscillation technique, used in the MINERVE reactor, allows low variations of reactivity to be measured [2]. The interest of oscillations originates in the ability to carry out neutron measurements using very low amounts of materials, e.g. a single fuel element, or a small sample (a few grams) of the body or isotope under investigation.

The technique consists in inducing a mechanical oscillation in the investigated samples at the center of the experimental lattice, so as to measure the related reactivity variation. The uncertainty about reactivity in relation to experiment reproducibility is lower than 1 %. Each sample is placed in an oscillation cane, and is displaced periodically and vertically between two positions respectively located in the median plane and outside the experimental zone.

The signal of the upper train (containing the sample under study) is compared with the signal of the lower train (containing a standard sample) of the oscillation cane (fig. 58). The reactivity impact discrepancy in two samples then makes it possible to go beyond the effect of upper and lower trains. Each sample is generally measured five times in order to identify the possible systematic biases, and reduce the typical discrepancy in the average measure. Typically, a measure consists in twenty oscillations, each being of 60 s.

The flux variation induced by the oscillation is detected by a **boron-lined ionization chamber*** called a pilot chamber, placed outside the driver zone, and controlled by an automatic fine control rod consisting of a stator and a rotor covered with cadmium sectors: their more or less significant overlapping induces a reactivity variation that may reach ± 20 pcm approximately. The correspondence between the rotation angle of the rod and reactivity is determined experimentally, using calibration samples with various ^{235}U enrichments and various ^{10}B contents, the reactivity of which is known over 1 % through deterministic calculations.

By quadratically cumulating the uncertainties relating to the measure reproducibility (~1 %), the materials balance of samples (~1 to 2 %), and the calibration of the automatic fine control rod (~2 %), the final uncertainty on reactivity is an approximate 3 % at 1σ .

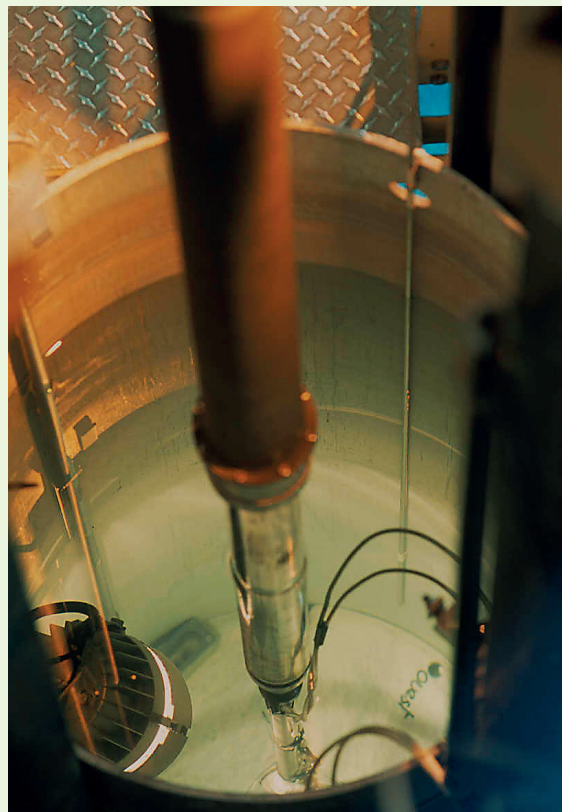

Fig. 58. View of the mechanical oscillation device in MINERVE.

The average amplitude of the automatic fine control rod is determined for each oscillation cycle. Comparing the amplitudes for each cycle of a same measure brings information about experiment reproducibility. Comparing the average amplitude of the five measures for a same sample gives information about measuring reproducibility. The average amplitude of all measures for a same sample is then compared with that of the calibration samples for the reactivity impact of the sample investigated to be determined relatively.

The experimental values are generally interpreted by an accurate perturbation neutronics calculation. In the calculation process, the reactivity impact of the samples investigated is also brought down to ^{235}U and boron reactivity impact, through the calibration samples.

Since the second 1986 half year, the MORGANE experiments dedicated to investigating light-water lattices of the **under-moderated*** type (RSM⁶) have been carried out in MINERVE ($\text{UO}_2\text{-PuO}_2$ fuel). The aim is measuring the global capture of fission products through irradiated fuel oscillation.

1993-2001: CREDIT BURN UP program, in which it was possible to measure the reactivity effects of the 15 most antireactive fission products (accounting for 80 % of total poisoning due to fission products) in dissolver, PWR-UOx, PWR-MOX, and BWR type spectra, and so to qualify their capture cross sections.

6. RSM: a French acronym for *Réacteur Sous-Modéré*: under-moderated reactor.

2003-2004: HTC⁷ Program, which consisted in measuring reactivity loss by cycle of UOx and MOX irradiated up to ~65 GWd/t, respectively in PWR-UOx and PWR-MOX type spectra.

This program will be completed in **2010** by the HTC-ALIX program for oscillations of UOx fuels irradiated up to ~85 GWd/t in a PWR type spectrum.

2003: VALMONT⁸ Program for qualifying the calculation form HORUS-3D used for the preliminary safety studies of the future Jules Horowitz Reactor (JHR), and its adaptation to the UMo/Al fuel specificities.

2005: ADAPh⁹ Program, achieved in a PWR-UOx spectrum, and aiming at qualifying the computational scheme HORUS-3D-P for **gamma-induced heating*** of the JHR devices.

Depuis 2005: Two oscillation programs have been alternately performed in various neutron spectra of interest: the OCEAN¹⁰ Program for improving basic data relating to neutron absorbers, and the OSMOSE¹¹ Program for validating absorption cross sections of **minor actinides***.

Jean-Christophe Bosq and Philippe FOUGERAS

Reactor Research Department

► References

[1] P. FOUGERAS, J.-P. HUDELLOT, D. RIPPET, F. MELLIER, P. BLAISE, M. ANTONY and N. HUOT, "*The place of ÉOLE, MINERVE and MASURCA facilities in the R&D and training Activities of the CEA*", PHYTRA1: First International Conference on Physics and Technology of Reactors and Applications. Marrakech (Morocco), 14-16 March 2007.

[2] M. ANTONY, J. DI DALVO, A. PEPINO, J.-C. BOSQ, D. BERNARD, P. LECONTE, J.-P. HUDELLOT and A. LYOUSSI, "*Oscillation experiments techniques in CEA MINERVE experimental reactor*", ANIMMA: *Advancements in Nuclear Instrumentation, Measurement Methods and their Applications*. Marseille (France), 7-10 June 2009.

7. HTC: a French acronym for *Hauts Taux de Combustion*, High Burn-Ups.

8. VALMONT: an acronym for Validation of ALuminium Molybdenum uranium fuel for NeuTronics.

9. ADAPh: a French acronym for *Amélioration des Données de bAse Photoniques*, improvement of photon basic data.

10. OCEAN: a French acronym for *Oscillation en Cœur d'Échantillons d'Absorbants Neutroniques*, incore oscillation of neutron absorber samples.

11. OSMOSE: a French acronym for *OScillations dans MINERVE d'isOtopes dans des Spectres Eupraxiques*, OScillations in MINERVE of isOtopes within "Eupraxic" Spectra.

CALIBAN: a Pulsed Research Reactor

Objectives of the CALIBAN reactor and facility description

Since 1971, the CALIBAN reactor has been under operation the CEA/Valduc Center of the Military Applications Division (DAM: *Direction des Applications Militaires*), near Dijon. Its operation is supervised by the Neutronics and Criticality Research Unit of the Nuclear Materials Research Department.

This compact and pulsed reactor, which generates an intense fission neutron and gamma burst, has been developed in order to simulate the radiative impact of nuclear aggressions on electronic components and systems, and to get a high-flux neutron source to meet research needs. Today, about three thousand critical experiments and almost two thousand shots have been performed on this assembly.

CALIBAN is a fast neutron reactor specially designed to operate in a pulsed regime, near the **critical*** state with **prompt neutrons***.

The reactor core consists in a vertical-axis cylindrical assembly (fig. 59). The fuel which it is made of, is (93 % ^{235}U) highly-enriched, molybdenum-alloyed (10 w. %) metallic uranium. This assembly is subdivided into two fairly identical parts that weigh about 50 kg each: the upper part stands for the "fixed block", and the lower, mobile part is called a "safety block". There is a 70 mm distance between the mobile block at rest

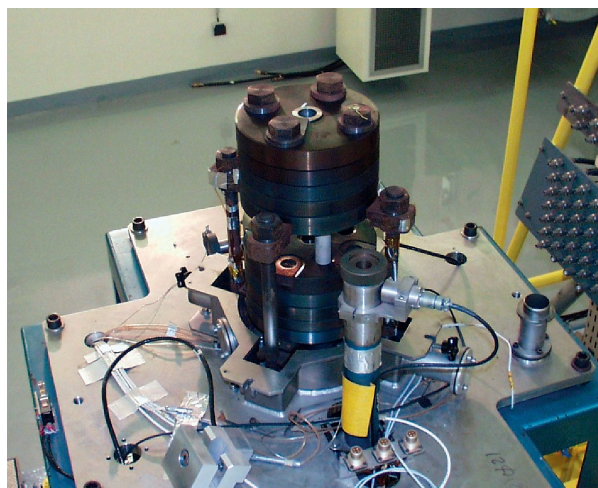

Fig. 59. CALIBAN reactor core after cover removal during the monthly operation of surface fuel disk monitoring.

and the fixed block. Once the core assembled, the resulting fissile orthocylinder is 252 mm high and 195 mm diam. A central hole, 30 mm diam., goes through the whole assembly, thereby allowing small specimens deep in the reactor core to be irradiated at the maximum **fluence***.

Each block consists of five piled disks made solidar by four stainless-steel bolts, with the coupled nuts being embedded in the fuel. The fixed block is kept in position with the help of four small steel columns solidar of the reactor framework.

Machine control is performed through three control rods and an excursion rod made of the same enriched fuel as the disks. These rods, of about 13 kg, are housed in four holes going through the assembly. Their motion is induced by a high-precision micrometric thread-bolt system, except the excursion rod, which is moved by a pneumatic jack within 200 ms.

The sudden introduction of the excursion rod brings the reactor to a **subcritical*** state with prompt neutrons. The neutron population then increases exponentially up to the instant when fuel expansion due to the internal heating of the fissile material entails a decrease in reactivity. The thermo-elastic wave which is then developing, allows the mobile block maintained in the upper position, "on contact" with the fixed block, to rest on the latter and be self-ejected.

The reactor core is surrounded by a cover which consists of two thin steel foils containing boron carbide powder. Its role is separating the fuel assembly from the outer environment (reflecting, moderating objects, cell walls), thereby absorbing thermal neutrons. This cover also ensures the containment of nitrogen used for core cooling after a shot.

The whole of the reactor and the associated mechanisms are located on an **elevating platform** which allows the core to be kept at rest in a concrete pit shut by a lead inspection cover. This sheltering of the core enables experimentators to enter the cell twenty minutes after the shot.

CALIBAN is installed in a broadly dimensioned cell (10 m long, 8 m wide, 5 m high), the concrete walls of which are 140 cm thick. The maximum distance between the reactor axis and the most distant wall is 6 m, while the side walls are 4 m away from this reference axis. Fifty connexions or so allow the measuring signals of the in-cell devices to be transferred to a remote dedicated room.

During a prompt neutron subcritical excursion, the peak power reached is an approximate 20 GW, and the pulse width at mid-height is neighboring the 60 μ s. The 200 °C internal core heating corresponds with a source term of $6.4 \cdot 10^{16}$ fissions. The resulting maximum flux in the central cavity is then of $5 \cdot 10^{18}$ neutrons.cm⁻².s⁻¹. Thanks to the absence of moderating materials, the neutron spectrum generated by this type of assembly is ideally similar to a fission spectrum (on the average, the history of a neutron only includes four inelastic shocks).

CALIBAN applications

Initially built to meet needs in electronics hardening for weapons systems, today programs implementing this test device are focused on a variety of topics such as:

- Safety criticality [10] [11];
- Dosimetry [1] [2] [3] [4];
- Materials behavior [9] [12] [13];
- Neutronics basic data [5] [6] [7] [8];
- Teaching.

Among the outstanding experiments of these last five years, it is worth mentioning the run relating to the reevaluation, in a fission spectrum, of the **cross section*** of inelastic scattering on the ²³⁵ isotope of uranium [5].

This run of 60 pulsed shots was carried out in collaboration with the teams of the Nuclear Physics Unit at the CEA/DAM Center of Bruyères-le-Châtel and with radiochemists of Los Alamos National Laboratory (LANL), this run of 60 pulsed shots once more demonstrated the interest of this type of fast assembly to achieve high-accuracy integral experiments, with many lessons learnt.

The CALIBAN reactor is acknowledged in the international community, especially thanks to the international criticality benchmark devoted to it in 2007 [10], whose data are fully accessible through the catalogue of the OECD's International Criticality Benchmark Evaluation Project. Certified modellings, issued from Monte-Carlo calculations performed with TRIPOLI-4 and MCNP codes, enable experimentators to achieve a fine simulation of the radiation source in the accurate conditions of their experiments.

As a conclusion to this non-comprehensive presentation of CALIBAN application areas, let us mention the yearly national benchmark exercises on dosimetry (fig. 60), which make it possible to usefully complete the knowledge acquired for several decades about the SILENE reactor, in this very specific field of radiobiology and criticality accident dosimetry.

Nicolas AUTHIER
CEA - Valduc Center,
Nuclear Materials Research Department

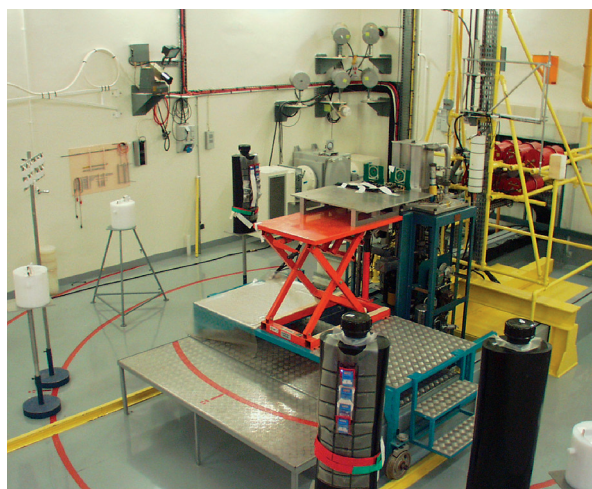

Fig. 60. Layout of dosimeters and phantoms around the CALIBAN core during the national benchmark experiment SPR 2008.

► References

- [1] F. TROMPIER *et al.*, "Dosimetry of the Mixed Field Irradiation Facility CALIBAN". Solid State Dosimetry Conference, n° 15, Delft, 2008, vol. 43, n°s 2-6 (1057 p.).
- [2] J. MORIN *et al.*, "Effect of the new ASTM E 722-93 (Si) Kerma displacement data on reactor neutron dosimetry". Nuclear Instruments and Methods in Physics Research. Vol. 402, n° 1, 1998, pp. 143-146.
- [3] J. MORIN *et al.*, "The PROSPERO and CALIBAN neutron irradiation facilities", Conf. RADECS 1991, La Grande-Motte, France.
- [4] J. DORLET *et al.*, "Reactor Pulse CALIBAN. Détermination des spectres appropriés de neutrons : Méthode Itérative Appliquée aux Détecteurs à Activation et de Fission", 2nd ASTM-Euratom Symp. on Reactor Dosimetry, ORNL, NUREG/CP-0004, 1977, vol. Z, pp. 667-682.
- [5] D. J. VIERA, "Measurement of the ²³⁵U(n ; n')²³⁵mU Integral Cross Section in a Pulsed Reactor", HAW09 Meeting of the Nuclear Physics Divisions of the American Physical Society and the Physical Society of Japan, Waikoloa Village, Hawaii, 2009.
- [6] P. HUMBERT *et al.*, "Numerical Simulation of CALIBAN Reactivity Perturbation Experiments", The 7th International Conference on Nuclear Criticality Safety, Tokai-mura, Japan, 2003.
- [7] P. HUMBERT *et al.*, "Simulation of Caliban Reactor Burst Wait Time and Initiation Probability using a Point Reactor Model and PANDA Code", PHYSOR 2004, Chicago, USA, 2004.
- [8] P. CASOLI *et al.*, "Reactivity Worth Measurements with CALIBAN and SILENE Experimental Reactors", International Conference on Nuclear Data for Science and Technology, Nice, France, 2007.
- [9] G. ASSAILLIT *et al.*, "Fast Burst Reactor CALIBAN", Conf. RADECS, Fontevraud, France, 1999.
- [10] N. AUTHIER *et al.*, "Metal HEU CALIBAN Reactor", ICSBEP Handbook HEU-MET-FAST-080, 2007.
- [11] P. HUMBERT *et al.*, "CALIBAN Fast HEU Core Reactor Critical Benchmark Evaluation", 8th International Conference on Nuclear Criticality Safety, St. Petersburg, Russia, 2007.

[12] P. CASOLI *et al.*, “*Calculation of Kinetic Parameters of CALIBAN Metallic Core Experimental Reactor from Stochastic Neutron Measurements*”, ANIMMA Conf. Marseille, France, 2009.

[13] N. AUTHIER *et al.*, “*Coupled Neutronic and Thermo-Mechanical Model of Super Prompt Pulsed Experiments at the Fast Burst Reactor CALIBAN*”, ANIMMA Conf. Marseille, France, 2009.

Testing Materials under Irradiation

In a nuclear reactor, materials are under severe loading conditions: they undergo thermomechanical and chemical constraints, and, last but not least, neutron irradiation.

In addition, the nuclear reactions which take place in fuel, generate fission and activation products that alter the physicochemical properties of the fuel. Therefore, the structural materials or fuel assembly materials have to meet very stringent specifications, *i.e.* ensure the good mechanical behavior of the fuel assembly and reactor internals, a key parameter to preserve core geometry. Concerning the reactor vessel, embrittlement under irradiation has not to take place in it. Fuel rods have to remain leaktight in order to avoid radioactive FPs release to the reactor coolant system. The phenomena to be tackled are related to corrosion by the coolant, thermal fatigue, materials embrittlement and deformation under irradiation, fission products and crys-

talline defects migration in solids. All these phenomena are intimately coupled, which makes it difficult to study them through modelling or with separate effect experiments. The latter are indispensable for understanding and controlling the phenomena above mentioned. Yet, they cannot be sufficient for qualifying vessel, structural, clad or fuel materials, an indispensable condition for reactor and safety performance. Most of this need is met by “materials irradiation” reactors, since the latter allow analytical tests on specimens and global qualifications of full-scale components, under temperature, pressure, chemical environment, and irradiation conditions representative of those to be encountered in industrial reactors under nominal or accident conditions. Indeed, they stand for the key part of the broad range of tools likely to help qualify nuclear reactor components. They are major research tools, with only a few of them available on each continent.

The OSIRIS Reactor

Why the OSIRIS reactor?

The OSIRIS reactor and the associated hot cells constitute a tool that allows for irradiation of samples or technological objects under a high neutron flux. The OSIRIS reactor (fig. 61) and the neighboring facilities, *i.e.* two shielded **hot cells*** and the ISIS reactor, meet a very high number of needs in relation to experimental and industrial irradiations.

The decision to build this reactor was made in 1963, and it completed the reactors serving the same purpose that were already operating then in France: “EL3”, under operation at Saclay since 1957, “SILOÉ”, at Grenoble, and “PÉGASE”, at Cadarache. Even though other European reactors had been recently set up then, the building of a new high-performance research reactor was required with respect to the huge task contemplated: improving knowledge about the in-pile evolution of the thermo-mechanical characteristics of materials to be used in the French nuclear fleet NPPs. So OSIRIS was set up at Saclay to benefit from the major technological infrastructure already existing: High Activity Laboratory (LHA: *Laboratoire de Haute Activité*), Irradiated Fuel Examination Laboratory (LECI: *Laboratoire d'Examen des Combustibles Irradiés*), facilities for radioelement preparation, halls for mounting, testing or measuring, near the Parisian industry and research laboratories.

The objective of this reactor was to achieve irradiations up to neutron **integrated fluxes*** representative of those undergone by fuels or structural materials in power reactors (*i.e.* about 10^{22} n/cm²). In order to limit the irradiation time to an accept-



Fig. 61. Overview of the OSIRIS reactor.

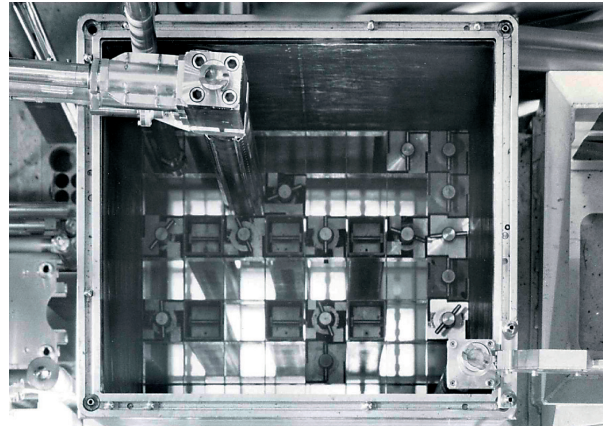

Fig. 62. View of the OSIRIS core.

able value, of about one year, instantaneous fluxes neighboring 10^{14} n.cm⁻².s⁻¹ have been required.

As regards experiments, the aim was to preserve a maximum accessibility to the core in OSIRIS (fig. 62), which led to the choice of a reactor block immersed in a pool, with no pressurization vessel.

The choice of the 70 MW power resulted from a compromise between:

- A need for high fast neutron fluxes in significant experimental volumes;
- A power compatible with the cooling water potential of the CEA/Saclay Center;
- A power that does not require too complex technical measures (low pressurization, and gamma-induced internal heating of intermediate intensity).

OSIRIS design

The importance of instantaneous fluxes in experimental locations within the reactor, as well as the core volume (resulting from the choice to use fuel elements of the same type as those of Pégase), have led to a specific power of about 400 kW per liter of core volume.

The choice of the pool reactor with no pressurization results in a limit of water rate between fuel plates, and so of the temperature level at which boiling appears.

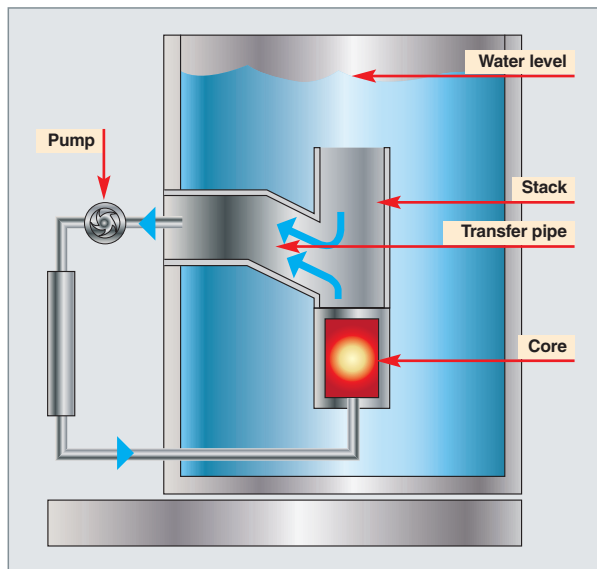

Fig. 63. Layout of the OSIRIS reactor block in the pool and water flow arrangement.

Besides, the pool temperature has to be kept lower than 40 °C, which, for high overall powers, means significant expenses for heat exchangers.

In order to achieve a core with a high specific power without using a pressurized water reactor, *i.e.* without losing easy accessibility to the core and having to use complex water systems, the core has been put in a vessel at the bottom of a high-depth pool. The bottom-top flow of water through the core was chosen as an option. For this down-up path is also that of natural convection, which avoids having to tackle with the delicate troubles due to the reversing of the water flow direction in the case of an accident.

The core vessel is overheaded by a stack, into which comes a side pipe collecting all of the rising flow.

In order to avoid uprisers the primary coolant circuit towards the pool, an up-down flow of about 150 m³/h is generated in the stack. This water addition to the reactor coolant system is compensated by a return of the same flow to the pool at the exchanger outlet (fig. 63).

The choice of a bottom-top water flow in the core raises the problem of fuel elements and experimental devices being liable to be lift off, being subjected to a hydrodynamic force higher than their weight. This is the reason why these elements, as well as the water boxes housing the experimental devices, are locked in their lower position, in addition to their being fixed to the upper grid. Besides, the **control rods*** have been equipped with counterweights in order to ensure their good operation.



Fig. 64. The control drive room of OSIRIS.

In addition, in order to keep preserving the ability to access to the core, control rod drives have been put in a room located under the pool (fig. 64).

OSIRIS present core consists of:

- 38 standard plate fuel elements (fig. 65);
- Six control elements containing a hafnium absorber part;
- Seven beryllium reflector elements (positioned on the Southern side of the core), some of which can house irradiation devices in a central hole.

At the end of the **irradiation cycle***, about one element over six is unloaded to be replaced by a fresh fuel element.

OSIRIS uses a fuel consisting of a silicide-type U₃Si₂ - Al alloy.



Fig 65. mockup of a standard fuel element for the OSIRIS reactor.

The standard fuel element consists of 22 plates, each plate containing the U_3Si_2 Al alloy 0.51 mm thick, clad with two aluminium-alloyed lids 0.38 mm thick. The cooling channel width between plates is 2.46 mm.

The box walls bearing the fuel plates contain boron (burnable **neutron poison***) used to lower neutron flux peaks that result from the excess reactivity available in the early irradiation cycle. It is so possible to achieve long operating cycles (4 to 5 weeks).

Each control element includes 17 fuel plates with the same constitution as that of the standard elements, overhauled with a hafnium absorbent element.

Core cooling (fig. 66) is ensured by a **reactor coolant system***, the flow rate of which is $5,500 \text{ m}^3/\text{h}$. The core inlet temperature is about $37 \text{ }^\circ\text{C}$, as against a core outlet temperature of $45 \text{ }^\circ\text{C}$. The reactor coolant system exchanges its heat calories with the secondary cooling system through once-through heat exchangers. The flow rate of the **secondary coolant circuit*** is $5,100 \text{ m}^3/\text{h}$. This circuit includes a cooling tower which induces the evaporation of 70 t/h of water when the reactor is operating at 70 MW. The physico-chemical characteristics of secondary water are maintained thanks to

the equivalent addition of 70 t/h of water, drawn from the tower recondensation tank, and its continuous replacement in this tank with an equivalent outer water addition of appropriate quality.

OSIRIS and ISIS reactor **containments*** are controlled-leak containments. The aim of ventilation is therefore to maintain the building at a constant negative pressure in order to contain possible radioactive gases and aerosols. A very high efficiency filtration retains particles with a diameter higher than $0.15 \text{ }\mu\text{m}$, and iodine traps are used in the case of an incident such as a fuel element or sample clad failure.

OSIRIS operation

Since 1966, three types of fuel have been successively used in OSIRIS. The "UAI" fuel until 1979, then the low-enriched UO_2 -based "caramel" fuel, adopted to meet IAEA recommendations about the use of low-enriched uranium in research reactors, and, last but not least, the "silicide" fuel adopted since 1997.

Table 10 on the following page mentions the main characteristics of these fuels.

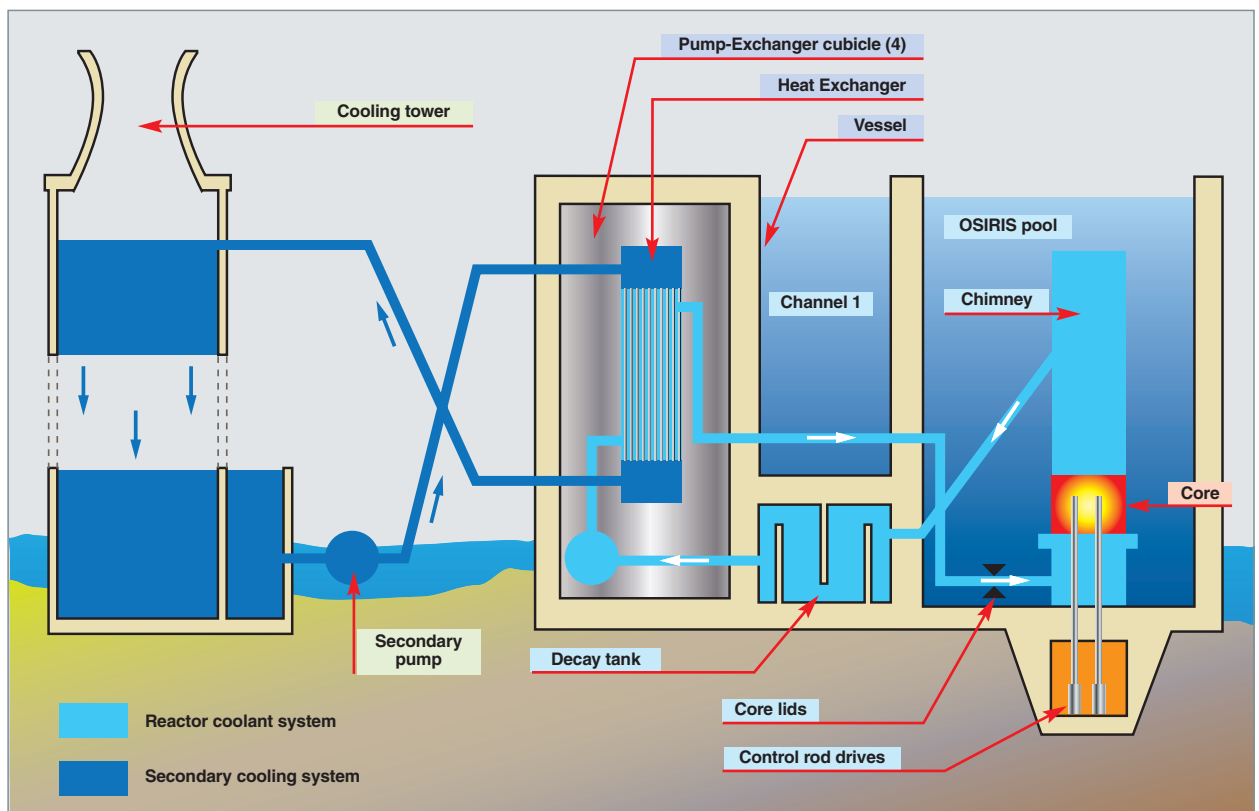

Fig. 66. Core cooling principle.

Table 10

Main features of the fuel used - neutron fluxes obtained with these fuels			
	UAI	CARAMEL UO ₂	SILICIDE U ₃ Si ₂ Al
Enrichment (%)	93.15	7.5	19.75
Number of in-core standard fuel elements	33	38	38
Number of in-core control elements	6	6	6
Clad	AG3	ZY4	AG3
U5 mass (kg)	11.63	21.6	13.6
U _{tot} mass (kg)	15.52	368	97
Core mass (kg)	480	982	574
Gamma heating in inner locations (W/g)	15	8	14
U5 mass/element (g)	390.5	662	458.35
Extractable power per fuel element (discharge burnup)	195 MWd (BU 60 %)	341 MWd (BU 52 %)	239 MWd (BU 60 %)
U5 consumption by MWd (g)	1.2	1.014	1.156
Thermal neutron flux in location 24 (10 ¹⁴ n/cm ² .s)	2.9 (in location26)	1.52	1.83
Thermal neutron flux in location 44 (10 ¹⁴ n/cm ² .s)	3.6 (in location34)	1.48	2.00
Thermal neutron flux in location 64 (10 ¹⁴ n/cm ² .s)	3.0 (in location42)	1.64	2.20
Thermal neutron flux in location 52 (10 ¹⁴ n/cm ² .s)	2.7 (in location76)	1.45	1.85
Fast neutron flux in location 24 (10 ¹⁴ n/cm ² .s)	2.2 (in location26)	1.07	1.09
Fast neutron flux in location 44 (10 ¹⁴ n/cm ² .s)	2.8 (in location34)	1.86	1.88
Fast neutron flux in location 64 (10 ¹⁴ n/cm ² .s)	2.6 (in location42)	2.06	2.00
Fast neutron flux in location 52 (10 ¹⁴ n/cm ² .s)	0.6 (in location 76)	1.82	1.88

N.B.: Text parts in color refer to locations in the core as shown on Fig. 69.

The reactor is operating during 200 days per year on the average, by cycles of 3-5 weeks. A shutdown of about 10 days between two cycles is required to ensure fuel reloading of the core, and perform light maintenance operations as well as handling operations required for experiments (fig. 67). The heavier maintenance is ensured during dedicated outages for longer periods of time.

Reactor operation is implemented by the shift team, which consists of 5 persons.

Six teams alternately intervene in a round-the-clock 3 shift operation mode in order to ensure the normal operation of the reactor. The operating team also includes fifty agents, among whom thirteen engineers, who are non-shift workers.

OSIRIS reactor safety

Operational safety displays two main, complementary features.

The first feature lies in ensuring an operational regime compatible with the defined conditions so as to avoid any dangerous situation.

Reaching this objective requires:

- Automatism likely to prevent any operational regime incompatible with the authorized conditions;
- Safety actions likely to entail emergency shutdowns in case of abnormal evolution of the parameters representative of the operational regime. Each of the safety actions is achieved starting from redundant devices, whose operation is regularly tested.

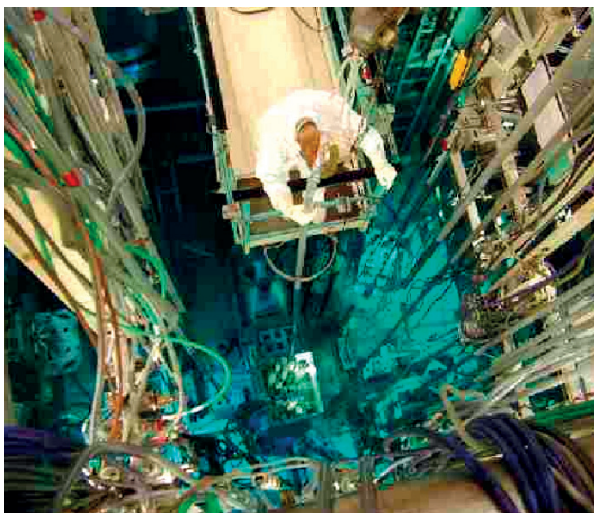

Fig. 67. In-pool handling.



Fig. 68. OSIRIS control room.

The second feature of safety means taking all the measures required for mitigating the consequences of an incident, using permanent autoprotective devices rather than automatic startup devices. It is worth mentioning the major among them:

- In order to remedy to a loss of cooling accident, the circulation pumps of the core and pool primary coolant systems are fitted with inertial flywheels sized in such a way as to ensure flow rates compatible with the **residual power*** levels to be discharged, and this until natural convection be sufficient to ensure residual power discharge;
- All the primary coolant system components are arranged in concrete compartments displaying such individual capacities that, in case of accidental transfer to the pool, water level in the latter cannot go lower than level - 4.5 m and, so, the core cannot be unflooded.

With a view to continuously improving nuclear safety, series of retrofits regularly take place in the facility, with safety reviews performed every ten years since 1999. Among the upgrades, it is worth to mention the replacement of the core vessel, the replacement of the diesel engines of the emergency generators, the retrofitting of the OSIRIS and ISIS I&C system (fig. 68), the emplacement of a water makeup circuit in the OSIRIS pool, significant improvements of containment leak-tightness, etc.

On the other hand, the operating personnel's permanent involvement results in a constant improvement of operating procedures.

Such improvements are going to be soon completed by enhancing the reliability of handling devices, emplacing an access hatch allowing trucks to be admitted in the rear zone of hot cells without any containment failure, improving the leak-tightness of the control drive hall, setting up emergency shut-downs following external aggressions (plane crash, earthquake, external explosion...), and the plugging of windows and inspection ports in the hot cell hall and the ISIS containment.

Conducting experiments

A pool reactor is so designed as to give direct access to the core, which is made easier by the absence of pressurization vessel.

The thick vessel walls surrounding the core on its sides avoid to use an inner baffle to withstand pressure. Moreover, these walls stand as a shield against gamma radiation for the experimental devices put outside the vessel.

Core visibility and accessibility make the handling of fuel elements and experimental devices (loading, unloading, and shuffles) very easy, avoid positioning mistakes, and make examinations and checks easier.

In the rack ensuring core stability, 5 locations are designed to house the experimental devices (fig. 69).

On the periphery of the core, on three sides of the vessel, three grids are arranged to receive irradiations in the **reflector***. So, experimentators can access to a broad range of locations providing a variety of fast and thermal neutron flux levels.

These grids have been arranged so as to house experiments for irradiating very long (up to 2 meters) PWR rod sections drawn from assemblies arising from nuclear power reactors.

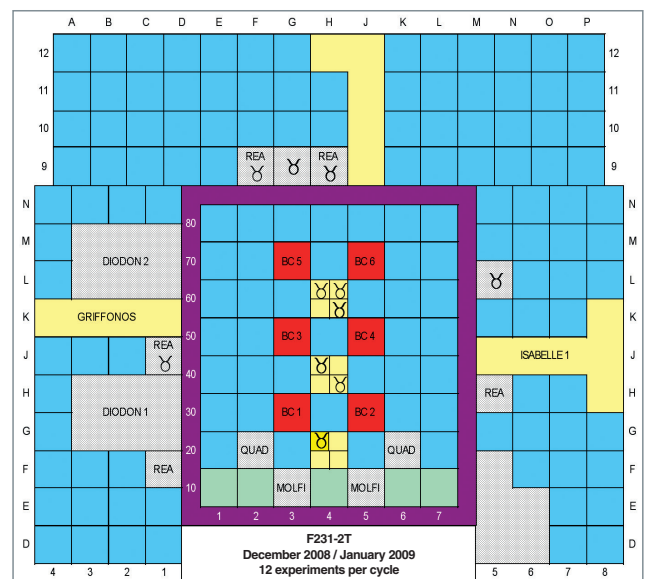

Fig. 69. Experimental locations in OSIRIS: an example of core loading. Red squares stand for core control elements. Green items represent the row of beryllium reflector elements. The indigo square stands for the vessel surrounding the core. Areas in yellow stand for locations used for experimental irradiation devices, and areas in grey, for other industrial irradiation locations.

Displacement systems make it possible to adjust the experimental device position in relation to the core in order to reach a precise adjustment of irradiation conditions, and achieve power variations (cyclings, ramps) representative of normal or incidental operating conditions in NPPs. Besides, these displacement systems allow experimental devices to be loaded and unloaded while the reactor is operating.

Industrial applications

Thanks to its especially high neutron flux, OSIRIS allows the industrial production of a high number of artificial radionuclides (fig. 70). These radionuclides are then used in the medical field by companies of the pharmaceutical industry, customers of the reactor. They allow medical diagnoses to be established by scintigraphy (OSIRIS ensures about 6 % of the (2007) world output of molybdenum-99), or some cancers to be treated by brachytherapy (see above the inset on artificial radionuclide production for medical uses, pp. 25-26).

Last but not least, in the field of the electronics industry, OSIRIS performs the irradiation of monocrystalline ingots of silicon (fig. 71), which alters the structure of this material and makes it semiconducting (fig. 71) (see above the inset on doped silicon production, pp. 28-29). Silicon “doped” by the phosphorus-31 generated through silicon-30 irradiation is utilized in industrial electronics for power components used, in particular, in inverters.

The electronics industry, mainly Japanese, gathers the main OSIRIS customers for this output.



Fig. 70. Handling of shielded containers containing radionuclides in the OSIRIS hall.

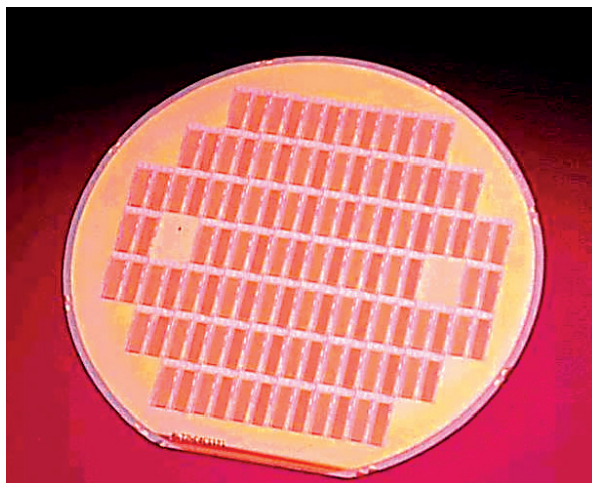

Fig. 71. Silicon wafer.

Irradiation experiments to investigate materials

The alteration of the mechanical and metallurgical properties of materials depending on irradiation limits their use under flux. This is why it is important to investigate the mechanisms associated with the degradation of their properties under irradiation, the major stake being the increase of economical competitiveness and lifetime of reactors. In this case, the main component involved is the **vessel***, and it has to be assessed whether its behavior remains acceptable after an irradiation corresponding with several dozens of operating years. A major experimental program was conducted at the CEA with this objective (TÉNOR, BARITON, SOPRANO, DV 50 and DIVA irradiations). During these experiments, the various irradiated test specimens allow the evolution of the various mechanical characteristics of vessel steels to be checked under significant **fluences***.

The damages generated in a vessel steel much depend on the temperature under which the irradiation takes place. So most of these experiments were conducted in devices named IRMA, which allowed specimens of material to be irradiated under controlled temperature, immersed in the OSIRIS pool near the reactor core (fig. 72). In these locations, the specimens receive within less than two years doses similar to those received by PWR vessels within several dozens of years. The IRMA device consists of 2 concentric tubes. Between the two tubes, a thin gas layer acting as a thermal barrier allows the temperatures of interest to be reached on the specimens. The specimen holder, at the center of the device, is immersed in an inert gas. The temperature of the specimens is reached thanks to their **γ -heating*** and that of the specimen holder. Temperature control and follow-up of γ -heating fluctuations are achieved using the electric heating elements borne by the internal tube. The main

characteristics of this device are: a useful loading volume of 700 cm³, *i.e.* a section of 6.2 x 2.5 cm² over a height of 45 cm; a neutron flux ($E > 1$ MeV) likely to reach 5.10^{12} n.cm⁻².s⁻¹; a gamma induced heating lower than 0.5 W/g; an experimental load temperature between 250 °C and 320 °C, with a ± 6 °C adjustment. The instrumentation includes 18 thermocouples and ratemeters distributed over the height of the specimen holder.

In the field of vessel steels, the IRMA devices are used, for example, to:

- Characterize temperature and dose effects;
- Assess the **toughness*** of the areas thermally affected by welding operations;
- Investigate the influence of the **neutron spectrum*** on fragilization;
- Investigate the annealing impact on the **ductile-brittle transition temperature*** of steels.

One variant of the IRMA device, featuring a fairly higher size, was developed to house test specimens of higher volume (CT50): this is the BARITON device.

Extending reactor lifetime also concerns the lifetime of reactor internals. In this case, it is necessary to use higher neutron fluxes, and so to be inside the OSIRIS core.

Experimental programs are also focused on fuel clad materials, such as, for example, irradiations intended to test zirconium alloy properties of growth and creep under irradiation at high **burn-ups***. As part of these experiments, the experimental load then consists of pressurized clads, whether pre-irradiated or not. Other stresses may also be applied to specimens during irradiation through implementing more or less complex systems in the specimen holders used. For example, in the EMMA program, the set of specimens, of a shape specifically designed and patented by the CEA, is subjected to a continuous pull.

Other types of reactor internals are also subjected to irradiation. For example, OSIRIS has hosted for many years experimental programs dedicated to the **pressure tubes*** of the **CANDU*** reactors developed by Canada.

The under-flux behavior of neutron absorbers, too, is analyzed under irradiation. The swelling of various objects in which gadolinium or other **“burnable poisons”*** are involved, can thus be investigated precisely. Other studies focus on the behavior of innovative concepts integrating this type of isotope within the fuel clad.

In order to achieve these irradiation runs, Type CHOUCA devices are implemented in OSIRIS. These devices dedicated to materials irradiation can be used inside or outside the core. Similarly to the IRMA device, the CHOUCA device consists of a double envelope which stands as a thermal barrier, and includes heating elements distributed over the height of the capsule in order to ensure a fine adjustment of specimen temperature all along the irradiation.

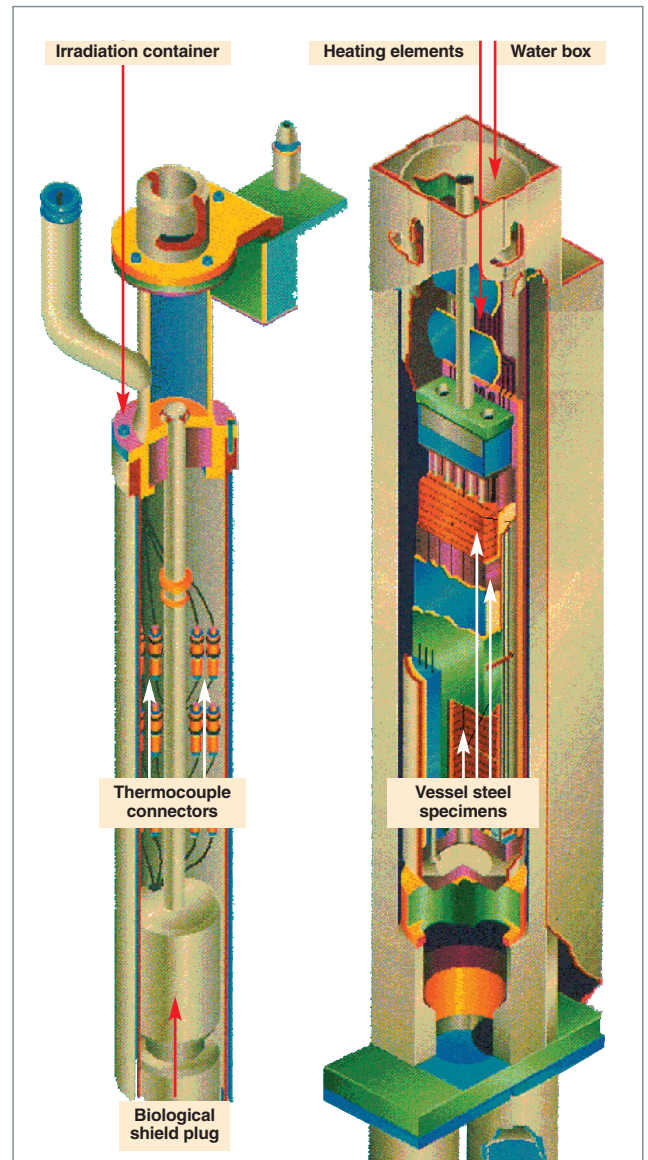

Fig. 72. The IRMA device for studying materials under irradiation in the OSIRIS reactor. Overview of the device (right) showing the location of the specimens to be irradiated. Details of instrumentation (left) for controlling temperature during irradiation.

The inside of the capsule is filled with NaK (sodium-potassium eutectic alloy) which ensures thermal homogeneity. In this medium is inserted a specimen holder that houses the specific specimens for each type of experiments.

The main characteristics of this device are: a useful diameter of 24-30 mm, a height under flux of 600 mm, a fast neutron flux ($E > 1 \text{ MeV}$) going up to $2 \cdot 10^{14} \text{ n.cm}^{-2} \cdot \text{s}^{-1}$, a maximum allowable gamma heating of 12 W/g, and usual operating temperatures of 250-400 °C, with a $\pm 5 \text{ °C}$ adjustment. The coupled instrumentation includes 12 thermocouples on CHOUCA, and 18 on the specimen holder, as well as ratemeters to access to the neutron fluence received by the specimens. A specific instrumentation associated with the experiment may also be added.

Irradiation experiments to investigate nuclear fuels

Improving operating flexibility and increasing fuel burn-up while scheduling their future following their stay in the reactor, are the major stakes of the R&D conducted on nuclear power reactor fuels. In particular, load following on French reactors involves fast power transients, which try the fuel intensively. Ensuring the good behavior of fuel during these transients implies controlling all the mechanical and physico-chemical interactions which take place between fuel pellets and their clad under irradiation, so as to avoid failures of this clad. As regards **pellet-clad interaction***, the stake is described in the Nuclear Energy Division's Monograph dealing with Nuclear Fuels.

Pellet-clad interaction

A broad R&D program has been undertaken within the three-partner framework EDF AREVA CEA and within bilateral contractual frameworks, so as to improve knowledge of the various phenomena involved in fuels and clads. Regarding OSIRIS, this experimental program includes many power transients (ramps) that make it possible to reproduce in a **loop*** (ISABELLE) the power transients, whether normal or incidental, to be encountered in power reactors.

The experimental load consists of a short fuel rod, either fresh or, most often, refabricated through the FABRICE process in hot laboratories, starting from a rod irradiated in an NPP. The thermohydraulic (temperature and pressure) and chemical conditions of water in the loop are representative of those prevailing in PWR or BWR power reactors. Rod cooling is ensured under forced convection by a flow of demineralized, degassed, and chemically conditioned light water. This flow rate is induced from a nozzle injector system which amplifies the flow rate produced by the pump unit of the loop feed circuit. This system allows smaller-sized lines to be used for connection with the cubicles which shelter the equipment required for coolant conditioning (pressurizer, pumps, exchangers...), hence a flexibility likely to allow for motion in pool.

The design of these loops and their positioning in the core peripherals allow their irradiation and removal during reactor operation. These devices are put on mobile supports, whose displacement in relation to the reactor core makes it possible either to adjust fuel power, or to carry out power ramps or cycles at variable rates using automatic control. Power variation is reached through displacing the under-flux part of the loop perpendicular to the reactor core, with the displacement being locked to neutron power.

The power likely to be released by the loop is 60 kW, and the maximum linear power density on the rod is 620 W.cm^{-1} , with a maximum "ramp slope" of $700 \text{ W.cm}^{-1} \cdot \text{mn}^{-1}$. During the experiment, the evolution of the various parameters is followed through the loop instrumentation (including an online neutron and γ spectrometry). The power released by the experimental load during irradiation is measured in real time using a thermal balance, with the help of flow rate, pressure and temperature sensors, as well as a neutron balance carried out with the help of self-powered neutron detectors. Possible fuel clad detection in a fuel rod is ensured by a detector of water gamma activity in the part returning to the out-of-pool part, coupled with a **delayed neutron*** detector.

Last but not least, a fine fuel characterization through non-destructive examinations (neutron radiography and γ spectrometry) is also ensured in the facility before sending the experimental load to a hot laboratory in order to carry out a number of nondestructive and destructive examinations (fig. 73).

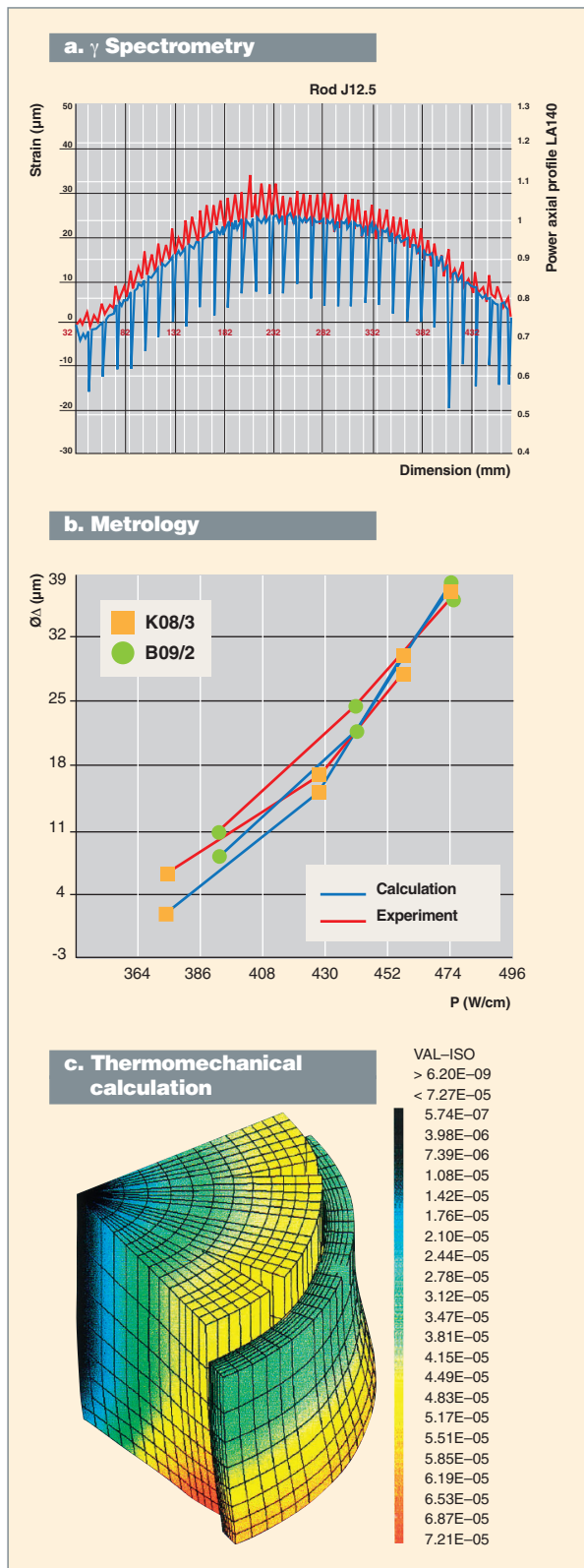

Fig. 73. Result of a thermal ramp test on an irradiated fuel of the ISABELLE loop: a) axial spectrometry of the rod; b) rod swelling; c) 3D finite-element calculation of the rod's thermomechanical behavior.

Improving MOX fuel performance

UOX* fuel of water-cooled reactors has already been qualified for a **burn-up*** of 60 GW-d/t, *i.e.* a value probably very close to the technical-economic optimum. MOX* fuel, which has been implemented for a shorter period of time, is still far from this objective. Yet, there is no reason to think that the intrinsic burn-up limits are very different for these two types of fuel. So, an additional effort is required to bring MOX fuel to an equivalent level, that is around 60 GW-d/t. For this purpose, another experimental device is used in relation to the analysis of fuel behavior under irradiation: this is GRIFFONOS.

The GRIFFONOS device is of the boiling capsule type: the release of the power generated by the fuel rod is ensured by natural convection of pressurized water. The maximum linear power density of the rod is 600 W/cm, and this value can be adjusted, as for the loop ISABELLE 1, by displacing the device with respect to the reactor core. The power released by the rod during irradiation is measured through a neutron balance done with the help of **self-powered neutron detectors***; it is then adjusted by quantitative **gamma spectrometry***.

In this device, the aim is to achieve irradiations of highly instrumented rods which are subjected to power variations. Thus, as part of the REMORA program, this instrumentation allows the evolution of pellet centerline temperature and the pressure of released fission gases to be followed simultaneously. An acoustic sensor has been added to the experimental load to allow the gaseous fission products of the helium released during transients, in the case of a MOX rod, to be discriminated. Still within the framework of the *Parité MOX* program, the REGATE irradiation has allowed the same helium release to be analyzed, this time through post-irradiation analysis.

Investigations for the future back-end of fuel cycle

As part of the back-end of fuel cycle front end, experiments for irradiating **minor-actinide*** bearing pellets are under preparation so that their behavior may be determined, and the feasibility of the various minor-actinide recycling options may be assessed, in accordance with the CEA's commitments in this field.

Measuring residual power

Other programs in support to the present fleet are conducted case by case in the reactor. Thus, in 2008, a new issue was approached in OSIRIS, *i.e.* residual power within the framework of the experimental program MERCI (see the inset below).

The MERCI experiment (*Mesure de l'Énergie Résiduelle de Combustible Irradié*)

Measuring residual power: objective and stake

During a reactor shutdown, the power released by the core does not fall instantaneously to zero because of the energy released by the radioactive decay of short-lived fission products. The power so released, named **residual power***, has to be discharged in order to avoid fuel overheating, or even core meltdown. This very residual power is what led to the degradation of the Fukushima Japanese reactor cores following the tsunami on 11 March, 2011, because this power could not be discharged on time.

The accurate assessment of this residual power makes it possible to define the limits of the maximum allowable local power in normal operating conditions and for the design basis of engineered safety systems. It is also an essential data in establishing procedures for fuel loading during nuclear plant unit shutdowns, or in ensuring the safety of irradiated fuel storage or transport conditions.

Residual power is relatively well known for long times, but much less for short times: in the second case, the major data is the contribution of very short-lived fission products, for which databases are rather inaccurate. The MERCI experiment (a French acronym for *Mesure de l'Énergie Résiduelle d'un Crayon Irradié*) precisely aimed at filling that gap and measuring the residual power released by a PWR fuel specimen after irradiation in well-defined conditions *as soon as the reactor had been shutdown*. Its innovative character lies in searching for acquisition of data relating to residual power at short times, considering for the first time all the physical phenomena related to the irradiation of a rod section, such as those used in a power reactor. Residual power sources, of varied origins (α , β radioactivity, neutrons, γ ...) arise from fission products and heavy nuclei, and so are very different at short times and long times. By convention, residual power may be taken into account starting from recognized standards, and, *in fine*, the aim is to be able to contribute to the establishing of such standards.

Once achieved, the experiment has been modelled and calculated with a *best-estimate* approach, using the neutronics codes TRIPOLI4 and DARWIN/PEPIN2. Confronting the calculation results with the experiment data then stands as an overall validation of the whole of calculation data: basic nuclear data, description of the evolution chains of the heavy nuclei and fission products taken into account.

Experiment progress

The MERCI-1 project, devoted to studying a fresh PWR UO_2 rod section, took place from 1999 to 2009. The years 1999 to 2004 were dedicated to the feasibility of the experiment and of the calorimeter. Equipment development as well as design and safety studies were carried out from 2005 to 2007, and the experimental step itself took place in 2008.

It is worth mentioning that the calorimeter, due to the accuracy required ($\pm 1\%$), needed conceptual innovations and technological developments which resulted in patent application. Its localization in shielded cell also proved a very hard constraint. In order to take account of the component of residual power transported by the γ radiation, it was necessary to place the rod in a bulk tungsten-made, thick-walled vessel. In such conditions, getting the value of residual power requires correcting the rough measure of γ residual leaks out of the calorimeter (calculated as about 4% using the TRIPOLI4 code), and taking into account thermal inertia phenomena. In order to maintain these phenomena as of second order, after the first instants of measurement, an extremely accurate adjustment of temperature ($\pm 0.01\text{ K}$) is fully required.

The so-called experiment took place in three successive steps in OSIRIS facilities:

- **Step n°1:** irradiation on the periphery of the OSIRIS research reactor (fig. 74): this first step has consisted in irradiating a fresh 3.7% ^{235}U enriched UO_2 rod section up to a burn-up of about 3,000-4,000 MWd/t ; for such a burn-up can ensure a good measurability of residual power over a two-month period of time, a relevant timescale, indeed, given the stakes. The rod was thus irradiated during 55 **JEPP*** at an average **linear power density*** per cycle fluctuating between 260 and 312 W/cm ;

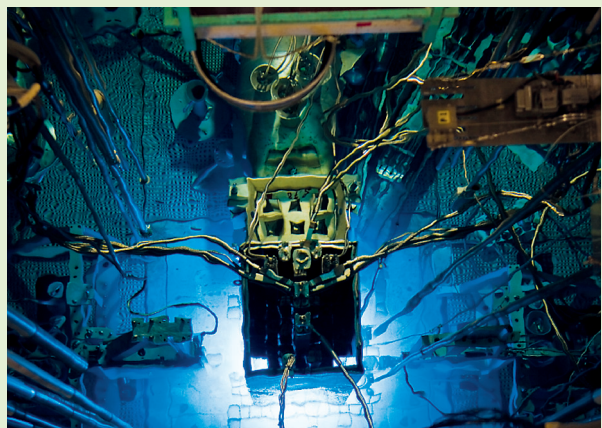

Fig. 74. The MERCI experiment: fuel rod irradiation in OSIRIS.



Fig. 75. The MERCI experiment: step of fuel transfer into the channel between the reactor and the hot cell.

- **Step n°2:** rod transfer following a scheduled shutdown of the reactor from its irradiation location to a hot cell, and then its emplacement into a calorimeter (fig. 75); this second step, which requires a team of twenty CEA persons, took place on 17 March 2008, with the rod being transferred within 26 minutes from the core to the OSIRIS hot cell n°2, and being placed in the calorimeter MOSAÏC. It constituted the key point of the experiment, the results of which much depended, indeed, on the transfer delay time, to be the shortest possible while complying with all of the safety measures inherent to the handling of nuclear irradiated fuels;
- **Step n°3:** measurement of the power released by the rod through the calorimeter MOSAÏC installed in a shielded cell at OSIRIS during ~2 months (fig. 76); that third step came to an end after 49 calorimetry days, and post-irradiation examinations then followed (γ spectrometry*, neutron radiography*, and pellet dissolution at Marcoule prior to isotopic dosing at Saclay).



Fig. 76. The MOSAÏC calorimeter for measuring residual power in shielded cells.

Interpretation

The interpretation of the MERCI-1 experiment required the fine modelling of fuel irradiation. Hence the implementation of a coupling between the TRIPOLI-4 transport code (**Monte Carlo*** neutronics code) and the evolution code DARWIN/PEPIN2, codes developed by the Department for Systems and Structures Modelling (SERMA). This model provides the isotopic composition of fuel at the end of irradiation. Starting from this composition, the DARWIN/PEPIN2 code then helps calculate the residual power released by the unstable nuclei generated during irradiation.

The characterization of fuel irradiation (**burn-up***), necessary for determining the fission number within the MERCI-1 rod, was performed starting from the measurements carried out during irradiation through a whole set of dedicated nuclear instrumentations (**fission chamber***, **self-powered neutron detectors***), and from the results of the post-irradiation measures by γ spectrometry and mass spectrometry for a certain number of heavy isotopes and fission products (^{137}Cs , ^{148}Nd , $^{235}\text{U}\dots$).

The calculation /measure comparison displays three distinct periods of time (fig. 77):

- **Short times:** from 27 to 44 minutes; the deviations $\left(\frac{C-M}{M}\right)$ evolve from -10 % to 1 %; the under-estimation of the calculation results from an overestimated measure following rod overheating before its introduction in the calorimeter;
- **Intermediate times:** from 44 minutes to 10 days; the deviations evolve from 1 % to 6 % after a 12h30 cooling time, and stabilize around 1 % between 4 to 10 days of cooling;
- **Long times** (not displayed): > 10 days; the experimental results have to be consolidated between 15 and 25 days, and from 41 to 49 days of cooling; yet, from 10 to 15 days, and from 25 to 34 days of cooling, the deviations fluctuate around 1 %; between 34 and 41 days, the deviations evolve from 1 % to -1 %.

Cumulated measure+calculation uncertainties (with one confidence interval) vary from 5 % (after 27 minutes of cooling) to 3 % (after 10 days). The deviations $\left(\frac{C-M}{M}\right)$ are included in the 1σ uncertainty interval, except the periods of time [27 minutes; 44 minutes] and [6h20 min; 1.5 day], when the deviations are included in the 2σ interval. These first analyses help improve the quantification of the uncertainties involved in the operation and safety files of reactors.

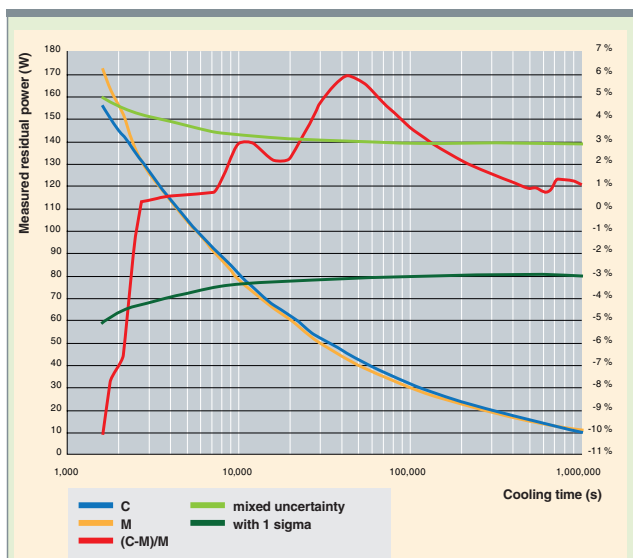

Fig. 77. Calculation/Measurement (C/M) comparison of residual power from MERCI-1 fuel.

Owing to its both highly innovative and highly technical feature, the MERCI-1 experiment required mobilizing for several years the CEA's major skills in a variety of disciplines (neutronics, radiation protection, thermal engineering, mechanical engineering, instrumentation, chemistry, experimentation...), and implemented several CEA/DEN's major facilities (OSIRIS reactors, ATALANTE and LECL hot laboratories, analytical laboratories...). The operational steering of this whole set of skills and means, going from the experiment design and its in-pile achievement up to its fine interpretation, resulted in the federation of the teams distributed among five CEA centers (Saclay, Grenoble, Cadarache, Marcoule and Bruyères-le-Châtel).

The experiment helped validate the basic principles and the original technical solutions selected, and, above all, helped reach the objectives in terms of transfer time and measure accuracy for the two-phase calorimeter. The residual power issued from MERCI-1 fuel mainly originates from the decay of uranium fission products. Thus, the MERCI-1 experiment helps qualify the component issued from these fission products to the residual power. Within a fuel displaying a higher burn-up, a not negligible part of residual power is due to the fission products of the heavy nuclei formed during irradiation. In order to qualify the plutonium and actinides components of irradiated fuels, a second experiment MERCI-2 is under definition. It is based on a MOX fuel with a high plutonium content (~9 % Pu).

Research on severe accidents

Irradiation in a research reactor also constitutes the first step of some research programs dealing with severe accidents in reactors. For example, the VERDON program consists in studying fission products and actinides releases by fuels in an accident situation.

In the VERDON experiments, conducted within an international framework, the experimental load consists of a very short fuel rod (2 or 3 pellets) refabricated in a hot laboratory from a rod irradiated in an NPP. This rod is re-irradiated in the OSIRIS reactor so as to reconstitute in the fuel rod the inventory of short-lived fission products before the accident (these are those radionuclides which are the most penalizing on the radiological level in the case of a severe accident). Then, this rod is quickly sent to the LECA laboratory at Cadarache. The accident conditions are then simulated there by heating the experimental rod in an induction oven and under a mixed atmosphere of water steam and hydrogen or air. Online **gamma spectrometry*** measurements ensure the follow-up of FPs release through the ceramic and, then, the fuel clad during the heating time.

Irradiation experiments for Generation IV reactors

Beyond the support to performance improvement for the Generations II and III of reactors, OSIRIS takes its rank in the international R&D program for the Generation IV of reactors, especially as regards gas reactors (HTR – VHTR – GFR). The specificity of these gas reactors is their very high operating temperature and, concerning the GFR, their high neutron flux. So the materials which are candidates for both structures and fuels, are to be qualified in these conditions. In order to reach an operating range consistent with these reactor systems, the NaK of the CHOUCA is replaced by a neutral gas, which has made it possible to achieve the CEDRIC experiment relating to the behavior of silicon carbide fiber strands under pull at temperatures over 900 °C. In addition to the temperature level, that experiment included two specificities: the pull applied to the specimen was controlled through a jack system, and its elongation was followed on line by an inductive sensor.

In order to go beyond, the CEA has developed a new device, named PHAETON, based on the CHOUCA concept, with which specimen temperatures over 1,000 °C can be reached with a control accuracy of ± 10 °C. The whole of the other characteristics are those of a CHOUCA. Within the framework of the 6th PCRD (Framework Program on Research and Technological Development), the PHAETON device has housed SiC and W specimens for the **blankets*** of fusion reactors (FURIOSO irradiation).

Qualifying MTR materials and future fuel

Apart from the reactors designed to generate (electrical or thermal) power, OSIRIS also prepares the future or irradiation reactors by taking part in the international program for the development of new fuels for this type of reactor, which uses UMo, a high-density, low-enrichment fuel likely to avoid the use of highly-enriched uranium (> 20 %) in experimental reactors.

For this purpose, the OSIRIS reactor houses within its core a specific device which receives experimental fuel plates with a size consistent with that of the reactor. This device called IRIS has been housing the experimental program bearing the same name for several years. It can receive up to four fuel plates simultaneously. At each cycle, the plates so irradiated are extracted from the device so that the swelling may be measured on a specific bench located in the facility.

In parallel to the fuel program above mentioned, irradiations are conducted in OSIRIS to characterize the materials specific to irradiation reactors. Thus, in support to the JHR design, irradiations are achieved in order to characterize aluminium, generally used for the reactor block.

Instrumentation

Last but not least, in order to improve the quality of the measures performed in research reactors, an instrumentation-dedicated R&D program is conducted at the CEA, partly in collaboration with the SCK-CEN in Belgium, to develop innovative and high-performance instrumentations. Let us mention, for example, the dimensional or optical-fiber spectrometric measuring methods, or the use of acoustic waves for characterizing fuel under irradiation. The corresponding irradiation programs allow these detectors to be qualified in conditions which are representative of their use in to-morrow's irradiation devices.

Michel AUCLAIR, Philippe DURANDE-AYME,
Stéphane LOUBIÈRE,
Reactor and Nuclear Services Department

Caroline VERDEAU,
Innovation and Nuclear Support Division

Richard LENAIN and Danielle GALLO
Department of System Modeling and Simulation

The Laboratories Associated with Research Reactors

Hot laboratories are facilities which experimental reactors have necessarily to be coupled with. They are required prior to in-pile irradiations to prepare the latter: fuel and rod fabrication for irradiations on fresh fuel, or, when the object has already been irradiated, refabrication of short rods, with or without instrumentation, in a hot laboratory. They are also useful at the end of the process, following irradiation, for performing destructive or nondestructive examinations.

Areas of activity of hot laboratories

The basic activities are related to the power reactor fleet, with two main chapters:

1. Activities coupled with the improvement of fuels (UO_2 and MOX) include monitoring programs for new fuels and clads, fuels at high **burn-ups***, fuel behavior in transient regime, the recycling of reprocessed* uranium and plutonium, **burnable poisons***, expertises of rods damaged in pile. Other topics are studies on safety, long-term storage, and transportation of fuels. The systems of the future also generate new needs, such as the fabrication and examination of **minor actinide*** bearing rods and targets, or carbide or nitride fuels.

2. Research activities on irradiated materials: vessel and internals steel, for monitoring NPP lifetime (AMI Chinon, VTT*...), inservice expertise of degradations for NPPs, chemical or radiochemical analysis for primary waste, clads (at **LECI***, see fig. 78 and 79), corrosion (in Řež laboratories), wall materials for fusion (for instance, at Jülich), examinations on graphite, etc.

In addition to this direct support of reactors, hot laboratories also allow the following activities to be conducted:

3. Studies on spent fuel treatment, as a support to plants (Sellafield and La Hague);

4. Radioisotope and radioactive source production, in relation to a neighboring research reactor (**HFR***, **OSIRIS***, **BR-2***);



Fig. 78. The LECI hot laboratory (Saclay) for investigating irradiated materials.

5. Some support activities, such as works on decontamination or waste (Chicade), or analyses related with environmental follow-up (Erlangen);

6. Examinations associated with **spallation*** irradiations, and analyses for nonproliferation.

Some laboratories have specialized in a cutting-edge field (e.g. materials for fusion at Jülich). A few organizations have specialized in metallurgical studies, others in radiochemistry (CEA), and others (ITU, EDF) encompass a broader spectrum, and gather a whole series of skills on a same site.



Fig. 79. A pulling machine in a LECI hot cell.

Hot laboratories in Europe

A twenty or so hot laboratories are available in Europe to achieve examinations on irradiated materials and fuels as a support to nuclear reactors (fig. 80). This fleet displays a high diversity in its research areas, *i.e.* fuels, materials, spent fuel treatment, radioisotopes and sources, in the size of laboratories, and in their evolution depending on national needs and constraints.

These facilities were often built in the sixties, in the early times of the nuclear industry, and are associated with a power reactor fleet, or to an experimental reactor.

All these hot laboratories exhibit the same architecture: one or several lines of hot cells, with varied shieldings (concrete, baryted concrete, lead, steel), a work area including remote handling systems, a rear area with a travelling crane for packaging handling, a powerful ventilation system, a room for radiation protection survey and ancillary rooms. Some of them include storage spaces (pits subdividing into cells, pool).

In addition to these hot laboratories, other laboratories are designed to study non-irradiated UO_2 or MOX fuels. All the levels of radiation protection can be thus observed, from the "cold" laboratory containing fresh UO_2 fuels or inactive materials to the shielded cell for investigating minor actinides, going through glove boxes for plutonium fuels.

These laboratories belong to state-owned organizations (**ITU***, **CEA**, **PSI***), joint fund companies (EDF Chinon, AREVA Erlangen), or even to private companies (Studsvik AB).

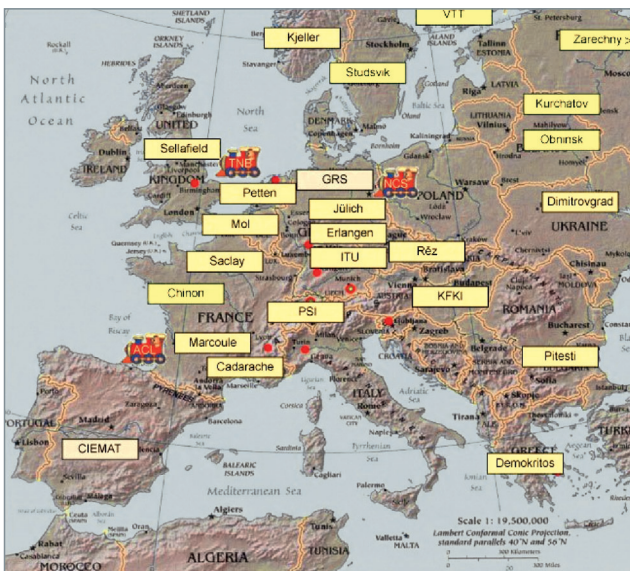

Fig. 80. European hot laboratories and nuclear materials transporters.

European integration

Cooperation between European laboratories and research reactors has been existing for a long time, through international programs including irradiation in a given country and examination sharing among other laboratories (PHÉBUS, OECD Halden programs). Such a practice is limited by transport difficulties. Domestic legislations sometimes exhibit constraints, for example they may impose waste return.

The following step of integration will be more delicate. Resources will have to be shared, with budget constraints: it is thus impossible to buy elaborate analytical devices (transmission electron microscope, **SIMS*** analysis, laser flash...) in each laboratory. Cooperation is a 'must', which implies transport of irradiated samples.

Within the Jules Horowitz Reactor project, it is scheduled to work with a number of hot laboratories. This will be done either at the reactor startup, or through the LECA - STAR laboratory as a turning platform.

The evolution and major upgradings of European hot laboratories

After a period of expansion associated with the startup of nuclear power, hot laboratories have experienced a concentration period as well as a reduction. As their hot laboratories are rather old, several countries, such as Switzerland, the United Kingdom and France, have launched ambitious upgrading programs. The construction of new laboratories in Switzerland and Finland will depend on the decisions to build new reactors. Canada considers to build a new hot laboratory, and so does China.

In France:

- At EDF, the AMI Chinon area has been limited: activities relating to fuel and control rods have been stopped, and all the fuel has been removed. Work is going on for irradiated metals, as well as vessel monitoring and expertises in support of the fleet. In 2004, EDF gathered its metallurgy and radiochemistry skills on the AMI Chinon site, transferring cold laboratories from Saint-Denis. The construction of a new building to replace the former one was launched in late 2009. This will be a mere radioactive classified installation for environmental protection or ICPE¹²;
- The CEA has optimized and rationalized its hot laboratory fleet: radiochemistry studies at Fontenay-aux-Roses were transferred to Marcoule (ATALANTE) in 1992, and hot laboratories (LHA: *Laboratoires de haute activité*) were closed at Saclay (2001-2003); in addition, activities relating to irradiated fuels at Fontenay-aux-Roses (RM2) and Grenoble (LAMA) were stopped to be gathered at Cadarache. Major

12. ICPE: a French acronym for *Installation classée pour la protection de l'environnement*.

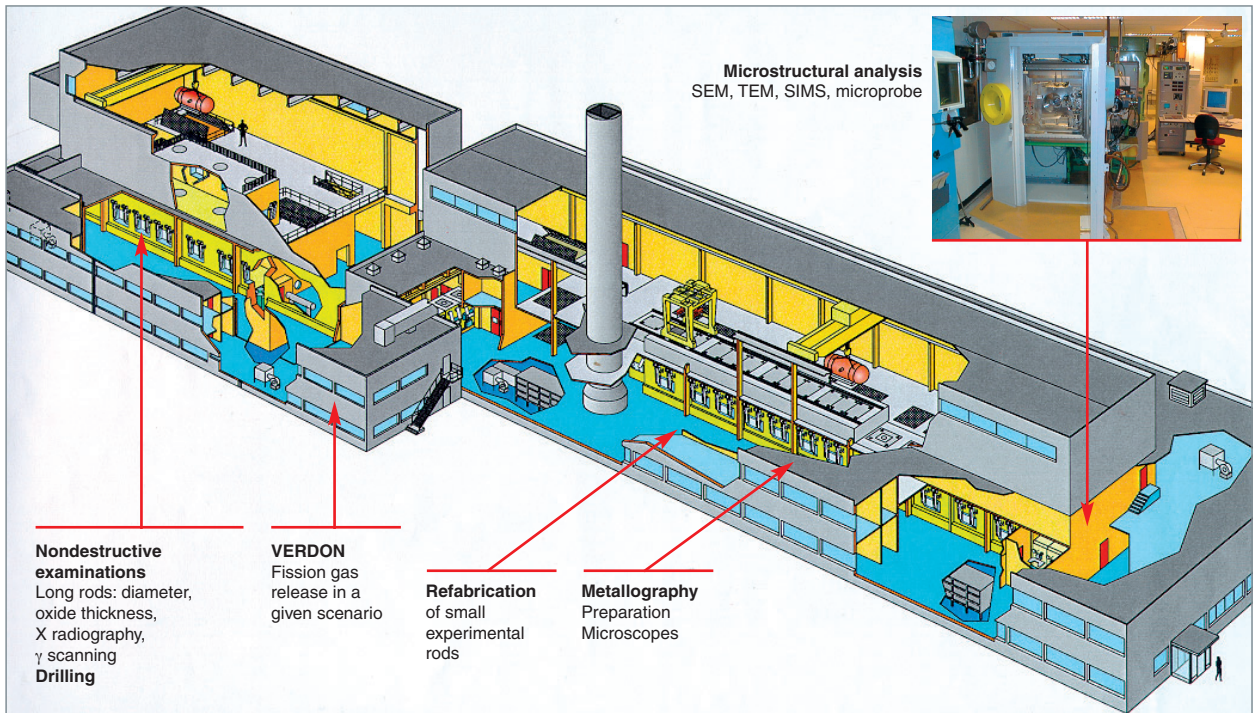

Fig. 81. The LECA-STAR at Cadarache: examinations performed on irradiated fuels.

upgradings were achieved on the remaining laboratories (LECI, LECA, LEFCA) in order to comply with present safety standards.

Hot laboratories at the CEA

Between 1995 and 2005, the CEA gathered its activities in the hot laboratories deemed to be necessary and sufficient to carry out development programs.

The rationalization performed by the CEA has resulted in the following situation:

- Irradiated fuels (LECA-STAR) at Cadarache (fig. 81);
- Irradiated materials (LECI) at Saclay;
- Back-end of fuel cycle (ATALANTE) at Marcoule.

Fuel-related activities are distributed among the following laboratories:

- The Bernard François laboratory for non-irradiated UO₂ R&D;
- The LEFCA for R&D dealing with MOX and fuels of the future, in glove boxes;
- The LECA for irradiated fuels;
- ATALANTE for minor actinide-bearing fuels.

Types of examination conducted in CEA's hot laboratories

Starting from irradiated rod sections, LECA and LECI make short rods (35-50 cm), named "Fabrices", which then undergo

power ramps in the OSIRIS reactor (type 2 transients, fig. 82) or in CABRI* (tests of the RIA*¹³-type accident transients). These rods may be fitted with a thermocouple or a pressure sensor, and even an acoustic sensor, for validating fuel simulation codes.

After in-pile irradiation, experimental fuels undergo nondestructive examinations at the LECA (visual examinations, crack detection, gammametry, deformation, X radiography), and then are punctured to quantify fission gas release, and are analyzed through microscopy (optical microscopy, SEM, microprobe, SIMS, X diffractometry) [fig. 83].

13. RIA: Reactivity-Initiated Accident, or Reactivity Insertion Accident.

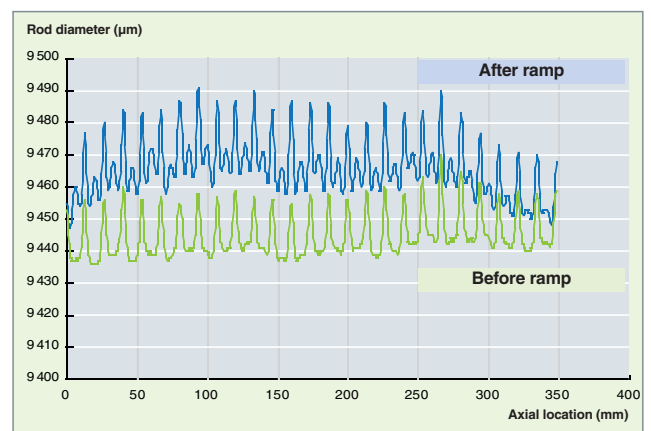

Fig. 82. Deformation measurement on a fuel rod subjected to ramp in OSIRIS.

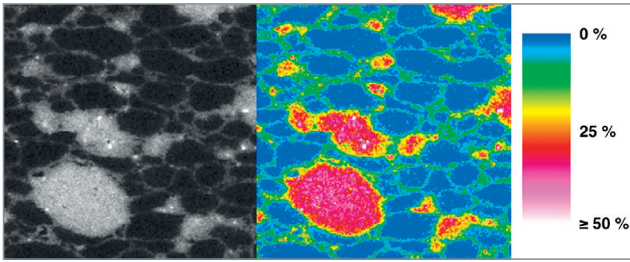

Fig. 83. MOX fuel microstructure displayed through electron microprobe (in color, Pu content). A plutonium aggregate can be seen in the bottom left hand corner.

In addition, the LECA has two facilities to investigate fission products release during irradiated fuels heating: MERARG, for studying the behavior in normal or accidental conditions, and VERDON, for simulating radioactive products release during a hypothetical severe accident on fuel freshly re-irradiated in OSIRIS (fig. 84).

The LECL at Saclay is equipped so as to be able to achieve any type of mechanical tests on metal (or even graphite or ceramic) specimens following irradiation. These tests help improve knowledge of vessel steel or fuel clad lifetime.

European hot laboratories are experiencing a deep evolution. This evolution depends on the local nuclear background, and is shown by closures, and organizational restructuring around some facilities, as well as upgrading, and even constructions. Besides, economic constraints induce a mutualization of examination tools. However, this trend is slowed by difficulties in transports and domestic legislations. European projects and international programs, such as the JHR launch, will boost this mutualization of research tools through a better integration of teams.



Fig 84. Construction of shielded cells for the VERDON experimental device at the STAR underground laboratory.

An example of research using hot laboratories: REMORA experiments to investigate fuel behavior under incident conditions

Experiments named REMORA (*RE-irradiation instruMentée dans Osiris avec mesure du Relâchement et de la température à cœur*: instrumented re-irradiation in OSIRIS and measuring of release and in-core temperature) have been conducted in the OSIRIS reactor during the recent years. They are dedicated to investigating the behavior in incidental situations of high-burnups UO_2 and MOX fuels irradiated in power reactors. These experiments, conducted in a partnership with AREVA-NP and EDF, allow the major phenomena occurring in fuel under irradiation to be better understood. They also provide the data required for validating thermo-mechanical codes which describe the overall behavior of the rod (the ALCYONE, CYRANO and COPERNIC codes, respectively for the CEA, EDF, and AREVA-NP), especially with the following studies:

- The study of thermal behavior and, in particular, of thermal conductivity degradation at high **burn-ups***;
- The study of fission gas release kinetics during power transients;
- And, in the case of MOX fuels, helium release kinetics with the aim of investigating the coupled behavior of fission gases and helium.

REMORA irradiations consist in re-irradiating high-burnup fuel rod sections, previously instrumented in a hot laboratory, during short experiments carried out in one of the OSIRIS devices (GRIFFONOS). Power histories of these re-irradiations consist of steps representative of powers in PWR reactors and of steps of incidental transient type.

These experiments have required the development and implementation of a fine instrumentation, the use of innovative fabrication processes, as well as the development of specific methods for achieving and interpreting the experiments.

Two experiments have already been achieved on high-burnup UO_2 fuels, *i.e.* a standard fuel irradiated during 6 cycles in a PWR, and a chromium oxide-doped fuel irradiated during 5 cycles in a PWR. For these first two experiments, a standard REMORA instrumentation has been installed on the fuel rod, *i.e.* an in-core thermocouple and a pressure sensor.

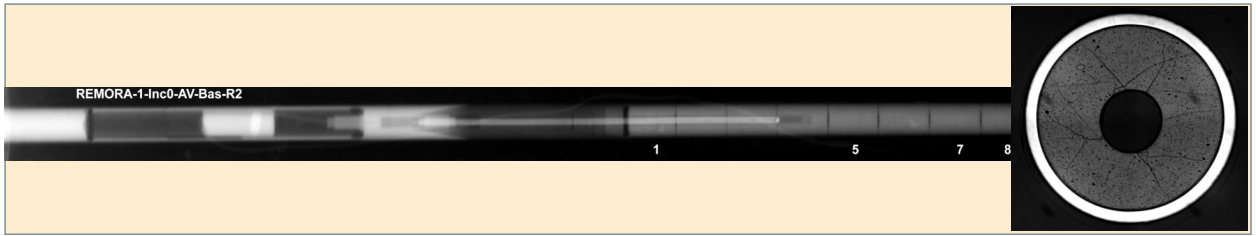

Fig. 85. Neutron radiography of the lower part of a REMORA rod, fitted with a thermocouple inserted in the rod for measuring centerline temperature.

The third experiment was performed in late 2010 on a MOX fuel irradiated during 5 cycles in a power reactor. In the case of MOX fuel, the standard instrumentation was completed with an acoustic sensor for online measuring of the evolution of gas composition during the experiment.

The design steps of the instrumented load and of the experiments were conducted so as to get reliable and precise experimental quantities, and are further detailed above:

1. For measuring the pellet centerline temperature, fuels pre-irradiated in a power reactor have been fitted with a core thermocouple (fig. 85). The implementation of this measure required the development of a drilling process without cryogeny, an innovative process specifically developed for the REMORA experiments. The qualification of this drilling process was conducted on UO_2 and MOX fuels irradiated from 2 to 6 cycles, with the aim of ensuring, first, the absence of impact on the microstructure (radial or circumferential cracking, tearing, grain alteration on the fringe of the hole...), and, second, the control of the hole geometry and the axial location of the thermocouple hot weld. The uncertainty on the temperature measure so obtained is lower than 1.5 % in a range of center temperatures measured up to 1,500 °C.

2. For measuring fission gas and helium release kinetics independently, two sensors are inserted on the fuel rod, coupled with a specific method (Tracer gas) for the uncertainty on the final helium balance to be reduced significantly:

- An innovative pressure sensor designed by the CEA, the so-called “counter-pressure sensor” (fig. 86), which is designed to carry out pressure measurements, especially during short irradiations, since the counter-pressure principle fully avoids any drift effect under neutron or gamma flux. The measurement uncertainty was determined during a qualification experiment under flux at ± 0.5 bar at 2s.
- An acoustic sensor designed for online measuring of gas composition inside the plenum. This sensor (fig. 87) was developed jointly by the CEA and the *Institut d'Électronique du Sud* (Joint Unit CNRS - Université Montpellier II), and was patented in July 2008. The general measuring principle consists in emitting an ultrasound signal in a dedicated cavity, and, starting from emitted and reflected echos, in accessing to gas composition through measuring the propagation rate of acoustic waves (time-of-flight measure). The measurement uncertainty is about 1 %, and is chiefly related to the uncertainty on the temperature of gases occurring in the measuring cavity.

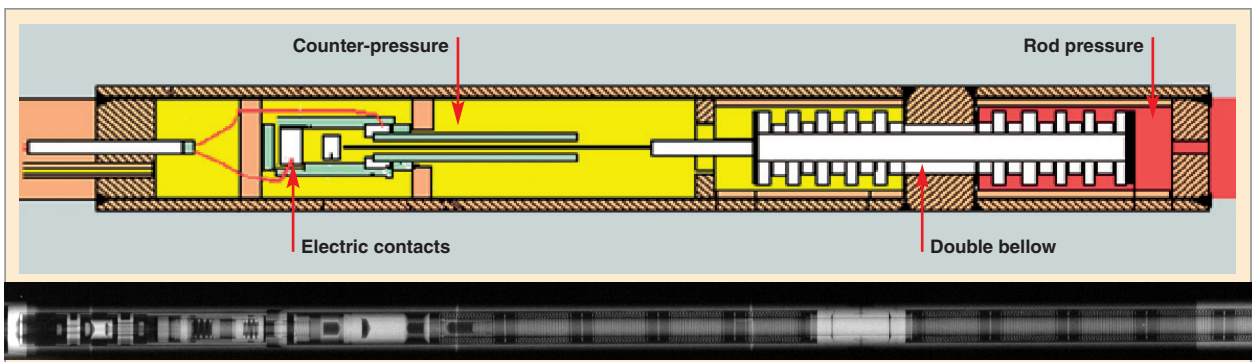

Fig. 86. Counter-pressure sensor for measuring pressure in the rod.

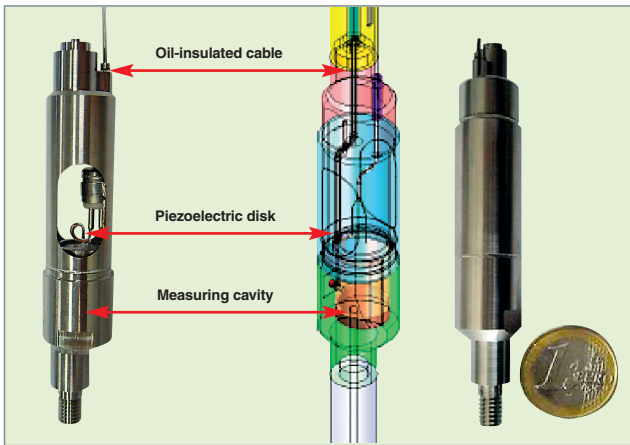

Fig. 87. An acoustic sensor fitted on a REMORA rod which makes it possible to measure the composition of the gases released in the rod. Measurement of gas molar mass.

- Adding a tracer gas to the filling gas of the experimental rod in order to reduce the uncertainty associated with helium release measuring at the end of the experiment. The principle consists in adding an additional element precisely quantified (tracer) to the filling helium, *i.e.* an element that experiences no or little alteration under neutron flux (captures) and is not generated by fission (or has a very low fission yield). Through measuring this element again after irradiation, it is then possible to precisely quantify the part corresponding with filling helium in the total (initial + released) helium measured. The resulting uncertainty on the quantification of final helium release is about 15 %.

Figure 88 displays the whole rod REMORA 3 with three instruments, integrated into the OSIRIS experimental device GRIFFONOS:

Thanks to the measures acquired and the fine interpretation of the first two experiments REMORA, it was possible to compare the behavior of standard and doped UO₂ fuels, taking simultaneously into account the thermal behavior models, the total quantity of released fission gases, and the release kinetics of these gases.

During these experiments, gas release kinetics (fig. 89) is calculated using the following items:

- The evolution of internal pressure measured on line,

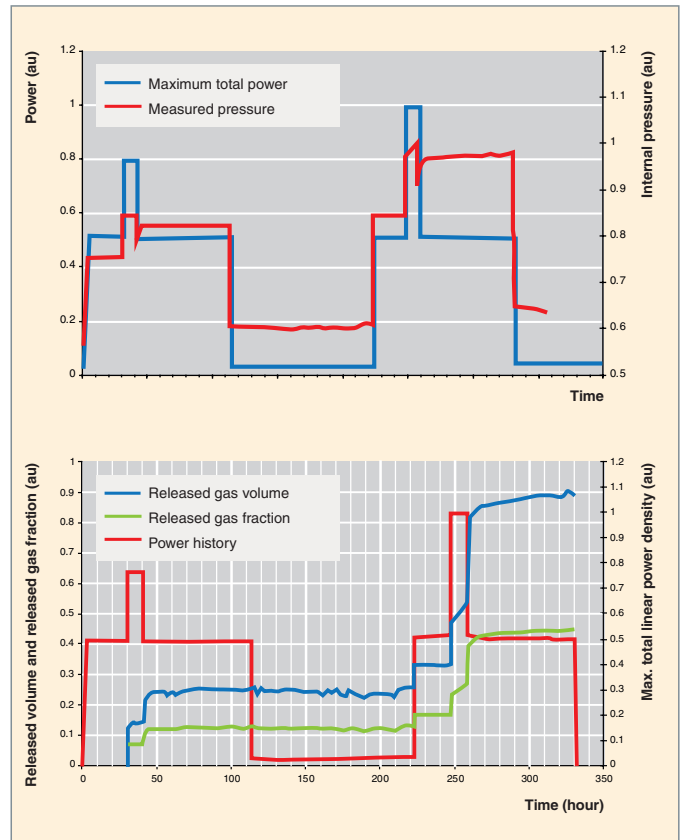

Fig. 89. Internal pressure and linear power density measured during a REMORA experiment. Evolution of the volume and of the calculated fraction of released gases.

- The evolution of the average temperature of gases in the free volume depending on linear power density: this evolution is obtained through specific thermal calculations and a particular measuring step performed at the start of the experiment,
- The evolution of the total free volume calculated with the fuel thermal-mechanics code.

So the first two experiments have evidenced the following features:

- The good agreement between the temperatures measured and calculated by the CEA fuel thermal-mechanics code over the whole of the field explored (fig. 90), with an effective con-

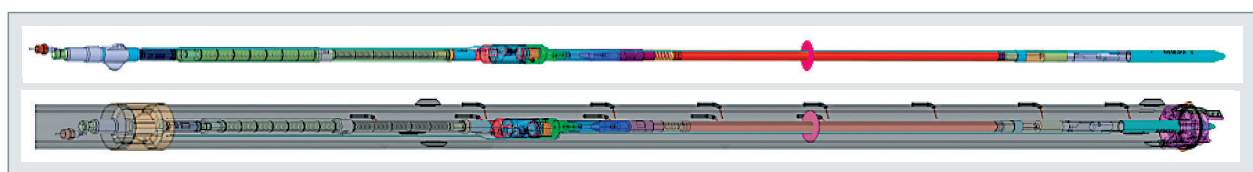

Fig. 88: Threefold instrumented rod REMORA 3 in its experimental device GRIFFONOS.

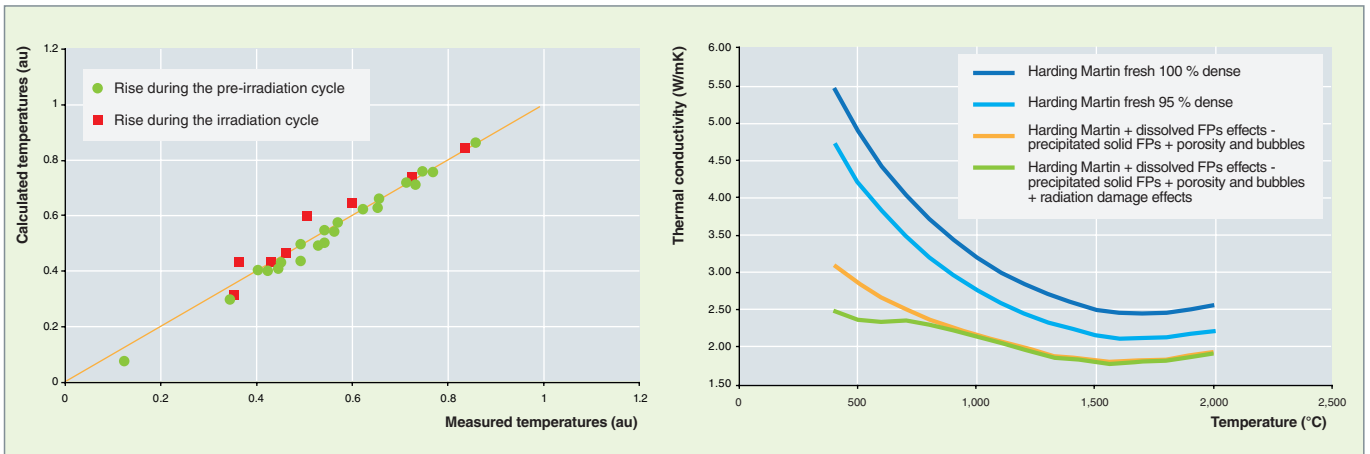

Fig. 90. Fuel temperature calculation/measurement comparison - Standard UO_2 conductivity laws.

ductivity of doped UO_2 fuel slightly degraded with respect to that of standard UO_2 .

- The best holdup capacity for the fission gases of the chromium-doped AREVA fuel in a transient condition,
- A fission gas release kinetics significantly different between the standard UO_2 fuel and the chromium-doped AREVA fuel.

The REMORA-3 experiment on MOX fuel, threefold instrumented (in-core temperature, internal pressure, gas composition), was carried out successfully in late 2010, and is under analysis. Through the online measuring of pressure evolution coupled with that of gas composition in free volumes, this irradiation gave access to specific experimental data about helium behavior and fission gas release (cracking mechanisms, occurrence of threshold temperatures, differentiated kinetics of helium and fission gas release...). It will significantly contribute to the validation of the helium release model RACHEL developed by the CEA. It will also result in the overall validation of thermal behavior models for a high-burnup MOX.

Jean-Yves BLANC,
Innovation and Nuclear Support Division

Thierry LAMBERT and Emmanuelle MULLER
Fuel Studies Department

► Bibliography

BLANC (J.-Y.), "Les laboratoires d'examens", Journée SFEN, *Les Moyens de recherche en support à l'évolution des réacteurs nucléaires*, Paris 19-20 octobre 2005.

<http://www.sckcen.be/hotlab/>

<http://www-nfcis.iaea.org/>

The Jules Horowitz Reactor

Launching the JHR Project

In the sixties, reactors designed to investigate materials and fuels under irradiation, such as OSIRIS (France), HFR (Netherlands), BR2 (Belgium), Halden (Norway), were financed and built within a domestic framework: these were the so-called MTRs (Materials Test Reactors). They brought an essential contribution to the safe development of a competitive nuclear industry.

Being near or over 50, MTRs taking part in developing the nuclear industry in the world are now victims of an increasing obsolescence. Therefore the renewal of this experimental capacity is an issue to be raised. A number of exchanges over this issue have taken place in Europe in the first half of the decade. A debate of the same nature also developed in Japan. The conclusion of these debates was that it is necessary to maintain an experimental capacity in the area of materials and fuels behavior under irradiation due to the general development of nuclear energy, the continuous evolution of safety requirements, NPP lifetime-related stakes, the search for competitiveness in NPP operation and fuels products evolution, as well as needs for innovation identified for future nuclear systems.

Given the time required for building a new MTR (over 10 years) and the importance of maintaining skills in this field, the JHR launch benefited from a consensus in Europe. A consortium of financing partners was created in 2007, thereby endowing the JHR Project with the status of an European "user-facility" open to international collaboration (fig. 91).



Fig. 91. Artist's view of the Jules Horowitz Reactor Project at the Cadarache site.

A new MTR reactor is a research infrastructure which will be structuring development capacities in fission for several decades. This is a costly investment, the initial specifications of which will determine the future added value.

On account of the following elements:

1. Water-cooled reactors will be in operation during the major part of the century; that is, the need for experimental irradiation will be tailored for several decades to the stakes relating to technological competition, lifetime control, and continuous improvement of safety referentials;
2. Meanwhile, requirements for sustainable access to nuclear energy call for the progressive development of technologies relating to fast neutron reactors;

The JHR has to be optimized in relation to two objectives, as a support to thermal neutron power reactors, and as a R&D tool for fast neutron reactors.

This compromise is delicate and has bounds:

- For thermal reactors studies, the nature of experimental needs is perfectly determined. The JHR has to meet these needs with well-controlled experimental technologies. The small size of the core requires very special efforts to control thermal and neutron flux gradients induced in specimens.
- Regarding the support to fast neutron reactors, needs are less known today. By precaution, the JHR has to be designed to provide a maximum capacity of fast neutron flux. However, in this very field, it will not be possible to conduct fully representative experiments in the JHR; only in prototype reactors of the concerned reactor systems will it be possible.
- Last but not least, for all reactor systems, the JHR will have to bring an essential experimental capacity for studying incidental and accidental operating regimes, that is it will provide displacement systems, a specific cell designed to ensure good management of fuel specimens deteriorated during experiments, a laboratory for online measuring of released fission products, etc.

The JHR design

The JHR was designed as a multipurpose 100 MW pool reactor which can house twenty or so experiments simultaneously and reproduce the specific environmental conditions of the various reactor systems and generations.

The reactor is associated with pools and hot cells which allow the experiment cycle to be managed efficiently. This whole constitutes what is called the nuclear island (fig. 92).

The reactor core, contained in a vessel about 60 cm diam. and 60 cm high, is cooled by a reactor coolant system under a 10 bar pressure.

The JHR has been designed to provide a high **flux*** of fast neutrons (a perturbed flux of $5-6 \cdot 10^{14}$ n.cm⁻².s⁻¹ and of an energy higher than 0.1 MeV) which allows a significant damage to be induced in structural materials (*i.e.* up to an approximate fifteen “displacements per atom and per year” - **dpa***/year -). Table 1 hereafter compares this damage with that to be encountered in various types of reactors.

Table 11

Representativeness of damage in materials accessible in the Jules Horowitz Reactor	
dpa undergone in the JHR / dpa undergone during the same period of time in the following reactor type:	
Water reactors	7
Gas-cooled fast reactors	1
Sodium-cooled fast reactors	0.5

The JHR was optimized so as to maximize this damaging capacity required to investigate materials for the reactors of the future (Generation IV).

The JHR also makes available a high flux of **thermal neutrons*** to study nuclear fuel behavior. Thus, regarding the present fuel, a ²³⁵U-1 % enriched rod in a geometry representative of a PWR can be heated to in-core melting of pellets. This performance is necessary to investigate the operating limits of fuels.

In addition to these two quantitative performances (fast and thermal neutron flux intensity), another essential qualitative performance is required: the ability to conduct quality experiments. In industrial reactors and prototypes, it is possible to achieve baking tests for materials or fuels; by definition, these tests are passive and are performed under conditions imposed by the reactor which houses them. Inversely, in the JHR as in all MTRs, it is possible to conduct instrumented experiments, to explore high-stress transients, to drive the experiment to specimen destruction, and to control gradients precisely, all of this with a fine control independent from the (possibly online) parameters and allowing separate effects to be investigated.

In order to reach the above mentioned performance objectives, an **under-moderated*** core had to be designed so as to get high fast neutron fluxes, with high power density, and high flow rate of the cooling water for remove the associated power. Thus, the JHR core consists of a rack 60 cm only in diameter, in which a plate fuel ensures a high density of fissile material. The gap between plates is reduced to the utmost in order to ensure core compactness and, so, its power density, and to limit the water volume and so minimize neutron thermalization. In the 37 cells of this rack, 34 to 37 fuel assemblies can be placed. A 15 m/s rate was selected for the cooling water going through the assemblies. Fuel assemblies are cylindrical in order to avoid vibrations given the cooling water rates. Neutron leakage in such a configuration is high, so it is used placing around the core a beryllium **reflector*** which ensures neutron thermalization. Thus, the peak of the resulting thermal neutron flux is obtained in the reflector a few centimeters from the core. At this location, the fast neutron flux remains significant. This provides exper-

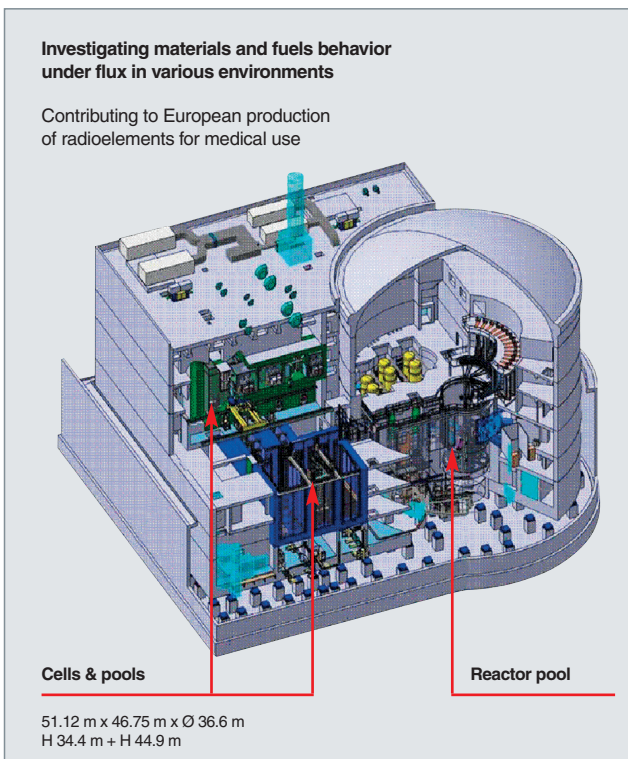

Fig. 92. Cutaway view of the nuclear island in the Jules Horowitz Reactor.

imental locations adapted to fuel studies, that require both thermal flux for the fast burning of **fissile*** material, and fast flux for the simulation of **clad*** damage.

Still with the aim of reaching flux performance targets while taking account of nonproliferation regulations which limit ^{235}U enrichment of uranium used in research reactor fuels to 20 %, the JHR uses a fuel with high density of uranium in order to compensate for reduced enrichment. This fuel is under development within an international framework (see the inset below).

Apart from neutron performances, another important field to be taken into account for reactor design basis is that of safety. If materials test reactors (MTRs) under operation are safe, it is still true, however, that their design took place almost fifty years earlier, and that the corresponding safety options are no longer acceptable today.

The JHR has been designed to meet modern safety requirements to be applied to the whole of nuclear facilities, whether they are power or research facilities.

Development of fuels for research reactors

Fuels for research reactors are characterized by high power densities so as to supply large neutron fluxes. They are designed for this purpose and, in the early decades when research reactors started to be developed, they intensively used ^{235}U highly enriched uranium (HEU), which was the simplest way to get the large fluxes required.

Since the late seventies, an international initiative has been launched so as to reduce and, at last, stop the use of HEU, considered to be proliferating, especially in research reactors: this is achieved through restricting, for their operation, to the use of Low-Enriched Uranium (LEU), in which the enriched content is lower than 20 %, and which is considered to be nonproliferating.

Fuels of research reactors display a high diversity of designs and shapes.

However, a number of experimental reactors in the world use fuels consisting of plates put together in cases or cylinders to form fuel elements (fig. 93). These thin plates (about 1 mm thick) consist of particles of a uranium metallic compound dispersed in an aluminium matrix, this metal being selected for

its good thermal conductivity, and the whole being covered with a clad most often made of an aluminium alloy.

HEU plate fuels consist of particles of a uranium-aluminium compound (named UAl fuel). The maximum uranium concentration obtained with this fuel is about 1.7 gU/cm^3 in the aluminium matrix.

Passing to low-enriched uranium requires, for both existing reactors and new reactors, an increase of this concentration so as to make for lower enrichment, and thus maintain high power density. A first step could be reached in the eighties, with the development of a fuel in which uranium particles were based on an uranium-silicon mixture (U_3Si_2 fuel), hence a uranium concentration in the aluminium matrix of 4.8 gU/cm^3 . Thanks to the implementation of this fuel, a high number of research reactors could be progressively “converted” to the use of LEU.

Yet, this U_3Si_2 fuel does not allow the “conversion” of the most performing research reactors, especially reactors dedicated to technological irradiations and reactors producing intense neutron beams to investigate matter, the latter requiring higher uranium concentrations for their performance levels to be maintained. So, in the late nineties, a new fuel started to be developed, that time consisting of molybdenum uranium particles (UMo fuel); it was expected to reach uranium concentrations of about $8\text{-}8.5 \text{ gU/cm}^3$, and was likely to undergo **treatment*** (reprocessing) as spent fuel.

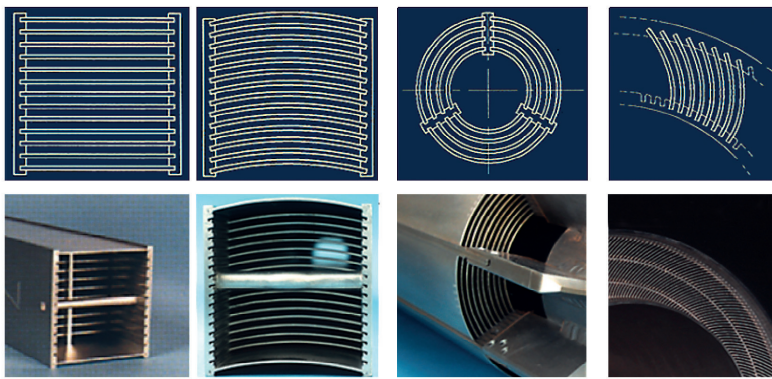

Fig. 93. Various models of plate fuels for research reactors produced by AREVA/CERCA.

The international community concerned, particularly the United States of America, Canada, France, Russian Federation, Belgium, South Korea, and Argentina, took measures to conduct the development of this fuel, including both qualifying qualification processes and demonstrating the good behavior of the new fuel under irradiation and its ability to be treated.

A number of qualification tests of this fuel under irradiation were performed in several irradiation research reactors, especially on full-scale fuel plates, under flux, fuel temperature and burn-up representative conditions. Several of these irradiations, among the most significant, evidenced abnormal swellings and blisterings in plate clads (years 2004/2006). As shown in the analyses performed, an interacting compound was formed between the UMo particles and the matrix aluminium, with bad properties with respect to both fission gas holdup and thermal conductivity. At the interface between this compound and the matrix aluminium, cavities were formed, where fission gases piled up, hence the swellings and blisterings observed in plates.

Since then, improvement paths have been defined in order to reduce or suppress these interactions between uranium and aluminium particles, and they are under qualification in irradiation reactors. These paths are, more precisely, the following:

- Silica addition in the aluminium matrix;
- Embedding of UMo particles with an insulating layer of a few microns (by oxidation, zirconium, zirconium/nitride).

Figure 94 displays the results of the UMo fuel tests under irradiation achieved in the CEA's OSIRIS reactor (IRIS Program), and the beneficial effect of silica addition in the aluminium matrix, and of the insulation of particles by their superficial oxidation.

The IRIS tests in OSIRIS have been applied to three types of UMo fuel plates:

- **IRIS 1:** Plates with UMo particles superficially oxidized and dispersed in an aluminium matrix;
- **IRIS 2:** Plates with UMo particles dispersed in an aluminium matrix;
- **IRIS 3:** Plates with UMo particles dispersed in an aluminium matrix including 2 w.% silica. [2 % en masse de silice].

The graph shows the evolution of plate swelling, in microns, as a function of the cumulated irradiation. It evidences the good behavior of the fuels for which the particles had been previously oxidized, or for which silica had been mixed with the aluminium of the matrix, in contrast with the fuel plates not including these improvements. In mid-program of irradiation, the latter exhibit excessive swellings (over 200 microns) which briskly emerged. Pursuing the irradiation would have led to clad failure in these fuels.

Last but not least, another alternative is also being developed, which consists in achieving a fuel made of a fine metal UMo plate (a fuel named "monolithic UMo") protected by a clad. This alternative makes it possible to reach uranium concentrations of about 16 gU/cm³, and so to convert the most performing existing reactors to low-enriched uranium. Hot spots requiring significant developments are related to the making of the UMo plate, whose thickness is a few tenths of a millimeter, and how to preserve fuel cohesion between the UMo plate and the clad.

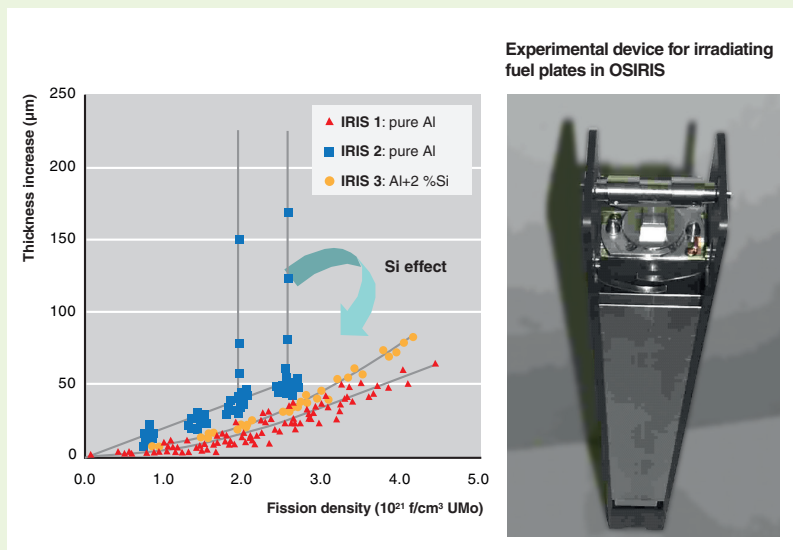

Fig. 94. Thickness evolution in fuel plates of various UMo-type fuels under irradiation in the OSIRIS reactor.

From TRITON to ORPHÉE, that is from the fifties to the eighties, the safety referentials of CEA's research reactors have been developed while a common guideline has been maintained for these reactors: simple and robust designs for controlled neutron performance, experimental concept validations, a **BORAX***-type reactivity-initiated accident taken into account, etc.

In order to meet safety requirements, a closed **primary coolant circuit*** has been adopted, which is a major disruption with respect to other research reactors developed by the CEA.

The design of the JHR core is a compromise between performance targets and safety requirements as the ring of the reactor coolant system is placed between the core rack and the reflector. This design exhibits the following advantage:

1. Core overpressurization, which helps improve fuel cooling;
2. Leaving the reflector out of the reactor coolant system. This design displays a high experimental flexibility: in particular, displacement systems can be emplaced which can make fuel specimens nearer or farther from the core, thereby simulating power transients or providing a safe position for special experiments (fig. 95).

However, this requires to subject the ring of the reactor coolant system perpendicular to the core to a higher neutron flux. So the qualification of this ring and its lifetime have become one of the more salient features of the projet.

From 1996 to 2001, the preparatory step of the JHR project allows its safety referential to be improved taking into account basic safety rules under application for power reactors, making design and construction codes for mechanical and electrical equipment, and drawing all the feedback of SILOÉ, ORPHÉE and OSIRIS safety reviews.

Modern basic principles have been applied to the safety approach: **defense-in-depth*** on several levels, application of the three **containment barrier*** principle, approach of radiation protection optimization. Other points have become a must in the demonstration of reactor safety, such as reactor-experiment coupling, human factors taken into account, handling of common-mode risks through geographic separation, materials diversification, etc. The application of these principles is based on identification and classifying in operating situations/conditions, on the study of internal and external aggressions, on the identification and classifying of safety-related elements, on the definition of quality criteria for all components, etc.

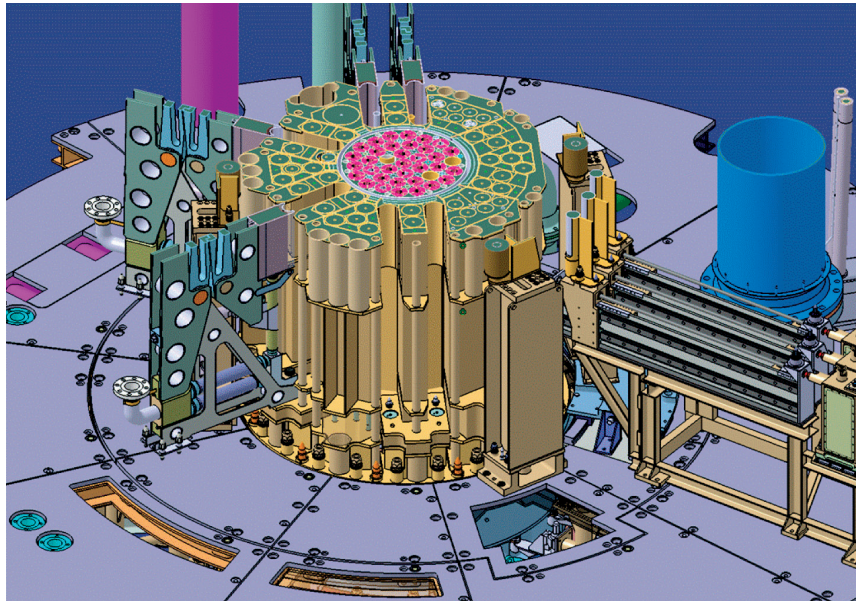

Fig. 95. Cutaway view of the Jules Horowitz Reactor core surrounded with its reflector and experimental devices.

This safety approach, validated by the Safety Authority, has resulted in the decree creating the regulated nuclear facility INB 172 – JHR on October 14, 2009.

The JHR construction started in 2007, and the commissioning is scheduled in 2016 (fig. 96 on the following page).

Daniel IRACANE,
*Innovation and Nuclear Support Division,
 JHR Program Director*

André CHABRE
Nuclear Energy Division

and Patrick LEMOINE
Innovation and Nuclear Support Division, JHR Project



Fig. 96. The Jules Horowitz Reactor construction site at CEA/Cadarache site (March 2011).

► Bibliography

DEN Monograph, *Nuclear fuels*. (See chapter on fuels for research reactors.)

VAN DEN-BERGHE (S.) *et al.*, "From high enriched to low enriched uranium fuel in research reactors", SCK/CEN (Belgium), *RGN review*, n° 6, 2010.

LAKOVLEV (V.V.) *et al.*, "The main results of investigation of modified dispersion LEU UMo fuel tested in the MIR reactor", HOTLAB Conference 2011, RIAR, Dimitrovgrad, Russia (2011).

Experimental Programs and Related Devices in the Jules Horowitz Reactor

Purpose of the JHR

MTR-type research reactors (Materials Test Reactors) are tools used to implement experimental irradiation devices with a view to the qualification of materials, fuels, or reactor components under nominal or accidental condition.

The JHR is now reaching a decisive step in a very particular background:

- On the one hand, the Generation II and III reactors under operation or to be commissioned in the following years will go on operating over several decades. Concerning these reactors, the support assumed by research reactors will mainly focus on extended operation issues (materials ageing) and improved performance, especially of fuels;
- On the other hand, the development of Generation IV reactors stands as a much more pronounced technological disruption. These reactors need new materials able to withstand fast neutron irradiations and high temperatures, and new fuels fully integrated in an optimized fuel cycle.

As a result, needs in experimental programs and related devices have been oriented according to the two following fields:

- JHR programs for supporting present and medium-term nuclear industry, which are dedicated to qualification of high-performance fuel for Generation III reactors: behavior in transient regime (ramps), analysis of released fission products, quantification of fuel clad failure margins in normal and accidental situations;
- JHR programs for the nuclear of the future: first focused on the (structures and fuels) materials considered for the corresponding reactors and, particularly, for sodium- or gas-cooled fast reactors.

Besides, it must be kept in mind that research reactors are tools to be tailored to needs and related programs which have not yet been identified at the moment of their design and their commissioning.

Experiment types in the JHR

The measures taken in research reactors and, especially, reservations of experimental areas are designed to allow a very broad range of experiment types to be achieved depending on the flux levels of interest, the available locations, the possible insertion of devices and loops with quite a variety of performances.

So the programs associated with materials and fuels development generally take place in several steps, especially as follows:

- Screening tests (searching for the most appropriate materials and the best microstructure in a situation close to nominal conditions of use): these are comparative tests for which the reactor is requested to have a high experimental capability for specimens to be tested;
- Characterization tests (a more extended area of study, but on a reduced number of specimens). Irradiation conditions then encompass a broader area than nominal situations, and generally extend to incidental, and even accidental situations. Very specific conditions, sometimes quite different from operating situations, may be required to improve physical knowledge, and to bring through experimentation basic data elements used as a support to computer modelling;
- Qualification tests that will aim at testing a product close to the industrial product (for instance, a fuel rod grouping the fissile material(s) and the various envelope(s) ensuring the containment of radioactive products;
- Safety tests used to investigate the behavior of fuel elements during hypothetical accidents (e.g. a Loss Of Coolant Accident - LOCA -).

For these different tests, experimental parameters are multiple, and will be tested individually (analytical tests) or simultaneously so as to study possible couplings, especially in qualification tests. In addition, these areas of interest are relatively broad, and imply specific environments and/or technologies tailored to each case. It is also clear that, as has already been mentioned, needs will evolve, and that the following description of the hosting devices only corresponds with the current view, even though some features are already known to be perennial over relatively long periods of time.

An experiment-oriented JHR design

The overall design of the Jules Horowitz Reactor (JHR) has been optimized to conduct the above mentioned experimental program. The JHR core, although being water-cooled, is designed to generate, first, a high fast neutron flux in the core in order to investigate materials ageing under flux or to achieve “fuel” tests requiring a fast flux, and, secondly, a high thermal neutron flux in the reflector to study fuel behavior.

The cavities likely to house irradiation devices in the core have a diameter ranging from 35 to 80 mm depending on size. In the reflector, the irradiation devices may be at a fixed position, i.e. power is then directly controlled through the reactor, or they may be mobile, i.e. power can be adjusted through simply moving the irradiation device from one location to another. The diameter is about 100 mm for the locations likely to house the mobile devices, but may be adapted (up to an approximate 200 mm) for “fixed” locations (fig. 97).

In order to create experimental conditions representative of real conditions in a nuclear power reactor, the irradiation devices inserted in the core or in the reflector reproduce a specific thermal-hydraulic / thermal environment, coupled with the flow of a coolant (pressurized water, gas, liquid metal...) displaying controlled characteristics (pressure, flow rate, temperature, impurities...). The corresponding equipment (pumps, exchangers, pressurization, purifying... systems, and related electrical systems) are located on the periphery of the pool in dedicated rooms. The facility design allows for significant ground loads, and supplies electric

power and cooling capacity of significant level, which will make it possible to install heavy, possibly shielded equipment.

In addition, it was deemed important to foresee the online follow-up of radioactive products released during an experiment, through collecting gas inside a leaktight rod under irradiation, or gas or liquid in the cooling channel in the case of clad failure.

The core is designed to operate under steady or slowly variable regimes. Experiments requiring fast power variations will be installed on displacement systems inserted in the reflector. The latter will allow adjustment of the distance from the core, and so of the power level in the device. These systems may simulate relatively fast power transients, such as, for example, uncontrolled rod withdrawal accidents. However, accident transients such as power excursions (the so-called Reactivity-Initiated Accidents, or Reactivity Insertion Accidents - “RIA” -) are too fast to be simulated using a displacement device, and are not taken into account in the reactor design basis.

The JHR experimental capability is typically twenty experiments or so simultaneously. The deployment of many simultaneous experiments in the same facility results in cost reduction for each experiment. This criterion is important in programs for materials and fuels development.

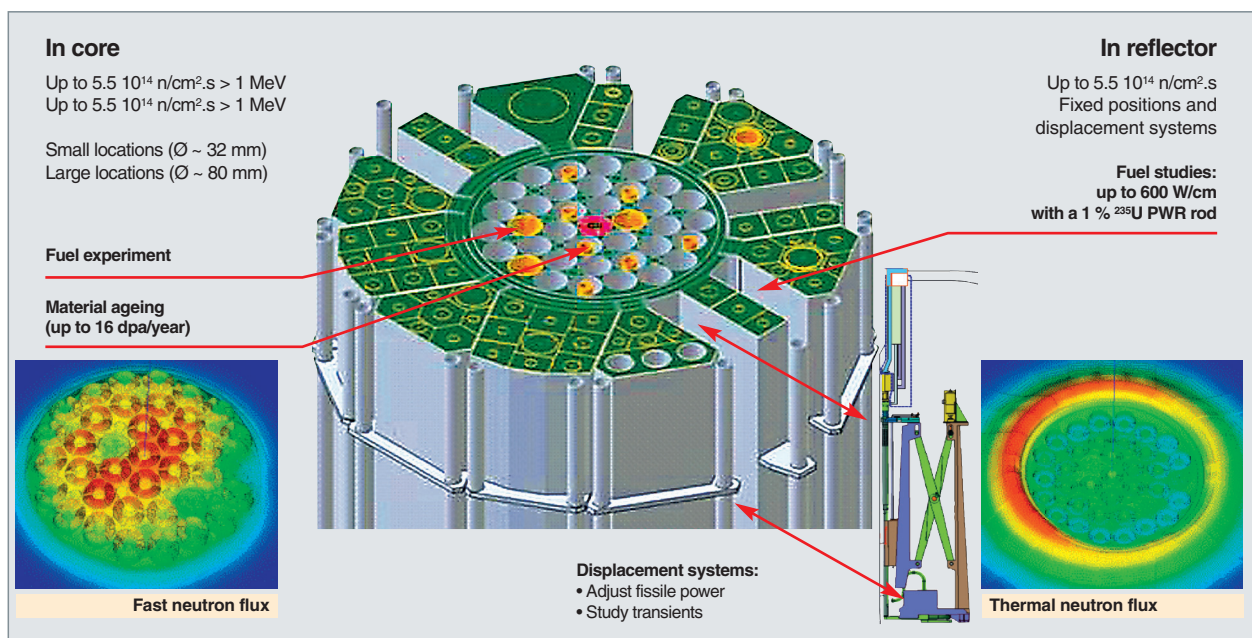

Fig. 97. Experimental device locations in the Jules Horowitz Reactor core.

Experimental hosting devices in the JHR

In the following pages, we shall mention hosting devices and “specimen holders”. Hosting devices are circuits which enable the environment of the experimental load to be controlled, and help carry out “experiment types” or “experiment families”. “Specimen holders” are introduced into these hosting devices using an appropriate instrumentation, thereby allowing one experiment to be performed. This differentiation is also representative of more or less long investment times: 40-50 years for the facility, about 10-20 years for the hosting devices, and from a few months to a few years for the specimen holders. The overall designs have to be as flexible as possible for the reactor to prove most attractive during its whole operating time: the hosting devices and the specimen holders will benefit from technologies more “focused” on the experimental need coupled to scientific or industrial news and to available technology.

Among the hosting devices under current development, to be operational as early as the first JHR operating years, let us mention:

MADISON (Multirod Adaptable Device for Irradiations of LWR fuel Samples Operating in Normal Conditions)

This irradiation loop was designed for long-term fuel irradiations in nominal conditions, such as those to be met in boiling or pressurized water reactors. These irradiations will be all the more attractive as there will provide an experimental capability for several rods, and the interest of comparative irradiations makes it necessary to get a homogeneous neutron flux level in the device (fig. 98 and 99).

This facility is especially dedicated to long-term effects; so it will be used to study fuel behavior under irradiation (microstructure evolution, fission gas release, swelling...), whether for screening experiments or for component qualification experiments. These irradiations require representative conditions not only of temperature, thermal-hydraulics, and neutronics, but also of water chemistry.

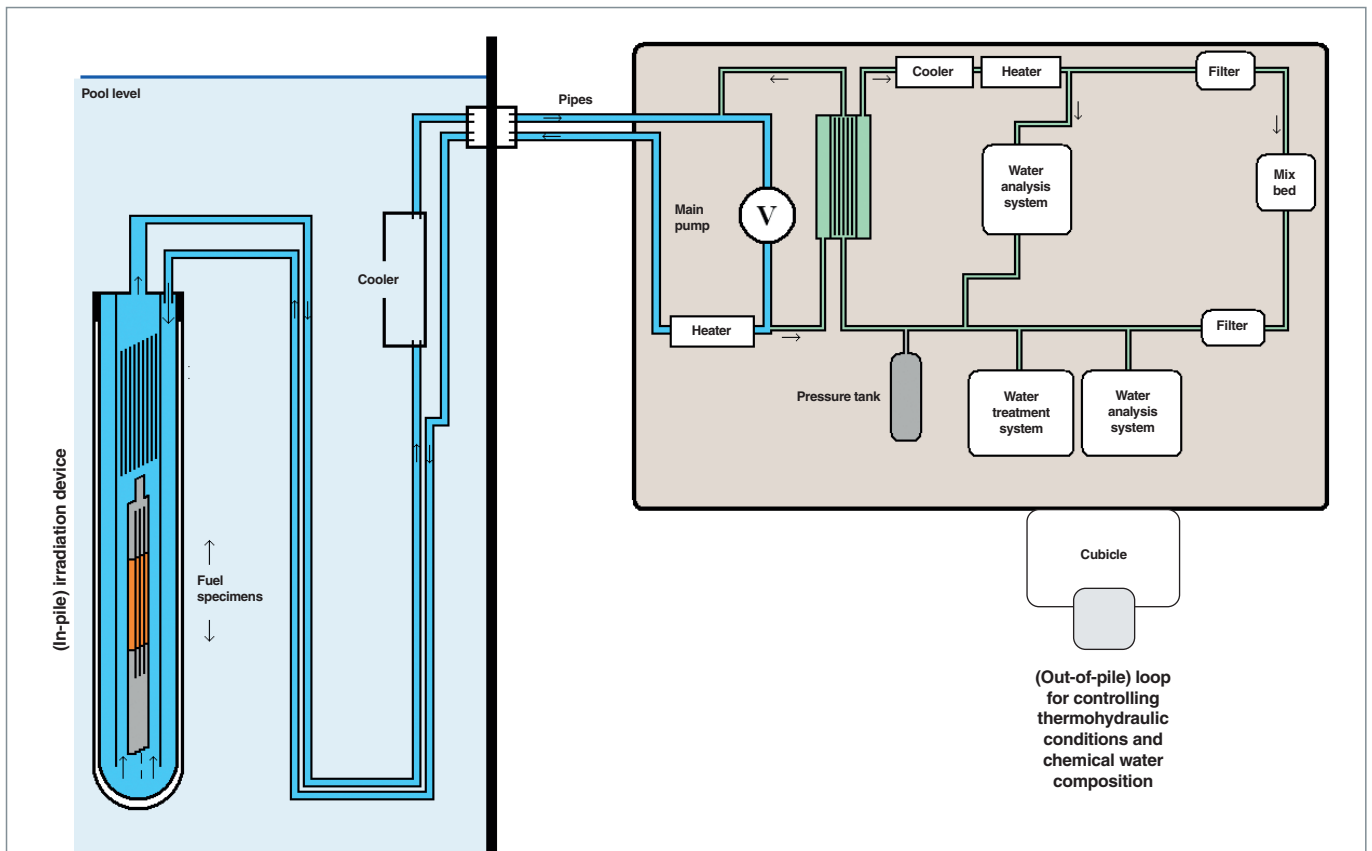

Fig. 98. The irradiation device MADISON for studying fuel behavior in “normal” conditions.

This hosting facility consists of one part located on a displacement system (for power level adjustment) so as to irradiate the test fuel, and one “on-land” part, which will ensure the thermal-hydraulic conditions (flow rate, pressure, temperature) and the chemical conditions (additives type B, Li, and H₂... This water loop also includes a purification system to remove undesirable elements).

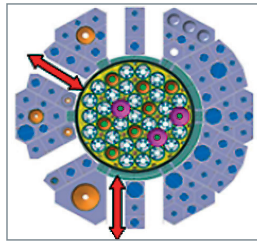

Fig. 99. Position of the MADISON device in the JHR core.

This hosting facility includes a part located on a displacement system (to subject the tested sample to the power transient of interest), and an “onland part”, which will ensure the circuit’s thermo-hydraulic (flow rate, pressure, temperature) and chemical (type B, Li, H₂... additives) conditions. It will also include an “FPs” removal system intended to remove the active elements released during the experiment.

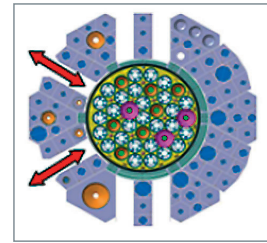

Fig. 101. Position of the ADELIN device in the JHR core.

ADELINE (Advanced Device for testing up to Limits Nuclear fuel Elements)

ADELIN is an irradiation system designed to test fuel beyond design criteria, so as to assess margins to failure, and even to operate with a failed clad (fig. 100-101).

So its aim is studying fuel in very high stress conditions. Let us mention for example the following cases:

- Behavior in power ramps;
- “Lift-off” (study of the clad lift-off risk in case of internal over-pressurization of one rod);
- Determining powers likely to induce fuel melt;
- Assessing releases of FPs and, if any, fissile materials into the primary coolant circuit under operation with clad failure.

So, tests are relatively short, that is from a few hours to a few weeks. They match with the categories of rod characterization / qualification tests.

These irradiations require that representative conditions of temperature, thermal-hydraulics and neutronics be reproduced.

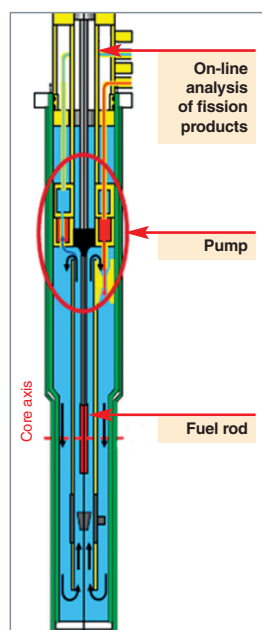

Fig. 100. The ADELIN experimental device for investigating fuel under “altered” conditions.

LORELEI (Light Water One Rod Equipment for LOCA Experimental Investigations)

This experimental device is dedicated to investigating loss of coolant accidents (see below the chapter on “Investigating Accident Situations”, pp. 113-118).

CALIPSO-MICA

These devices are dedicated to materials irradiation, and are thus aimed at investigating their mechanical behavior under irradiation in homogeneous and precise thermal conditions. In order to fulfill the second condition, these devices operate “in the NaK mode” (a sodium-potassium eutectic which is liquid at room temperature). Temperature control is achieved using gamma induced heating as a heat source (generally with additional heat from an electric source), and adjusting thermal leakage through the outer walls of the device (power removal is ensured by the core coolant water).

CALIPSO (In Core Advanced Loop for Irradiation in Potassium-Sodium): this device is dedicated to materials irradiation in the central area of the core, where the fast neutron flux makes it possible to reach relatively high “damaging rates” (16 dpa/y) (fig. 102-103). Given the rather high intensity of gamma induced heating in the central area, and in order to ensure a very good thermal homogeneity of the experimental load (*i.e.* < 6 °C for a typical load of 60 cm), NaK is sent into the circuit using an electromagnetic pump installed in the device itself (above the area under flux).

MICA: this device is dedicated to materials irradiation in the core intermediate area (half radius) or in the peripheral part of the core. The less intense gamma induced heating allows for the device to operate under a steady NaK regime, the axial thermal homogeneity being ensured by compensating the gamma heating profile with heater elements axially distributed (less powerful in the central area), and also by adapting the axial profile of thermal insulation thickness.

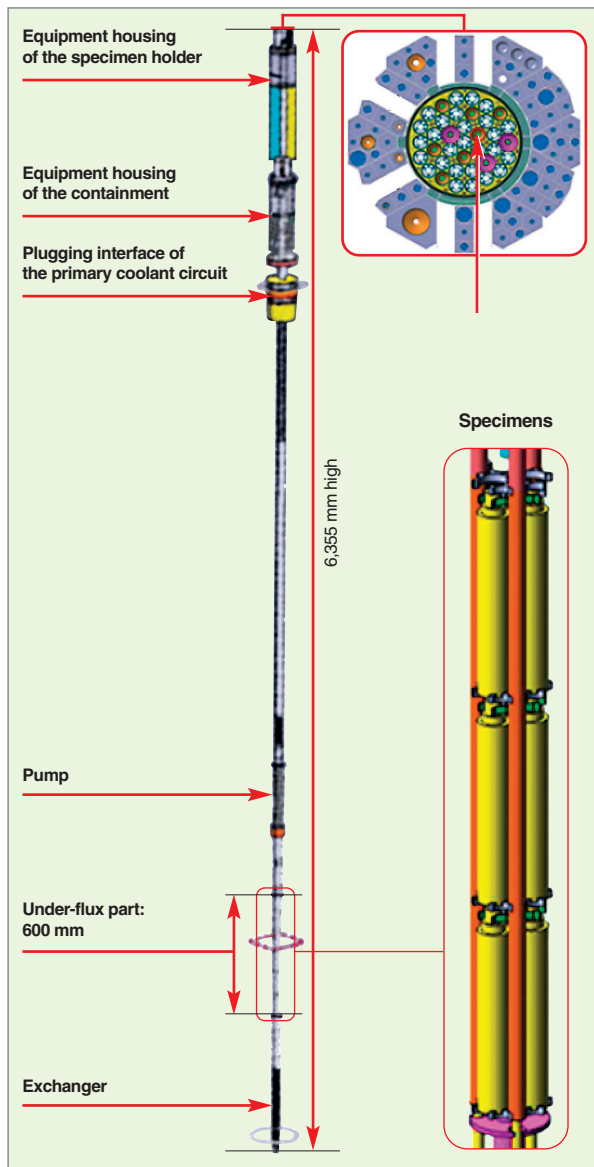

Fig. 102. The experimental device CALIPSO for studying the thermomechanical behavior of fuel under irradiation.

In the present state of their design, the devices previously mentioned are designed to operate in the 250/400 °C range, which corresponds with the light water reactor (LWR) system; their design basis will then be adapted to the 450/600 °C range in order to meet the needs of the fast neutron reactor system. As regards the high temperature ranges (1,000/1,200 °C), a MICA-derived technology already implemented on OSIRIS will be used. The principle lies in operating the device “under a gas regime” instead of using NaK as the load environment.

The previous descriptions correspond with devices which are in line with present demands, and are mainly oriented to “light water reactors” Devices dedicated to the sodium and, possibly, gas fast neutron reactor system will be designed as a function

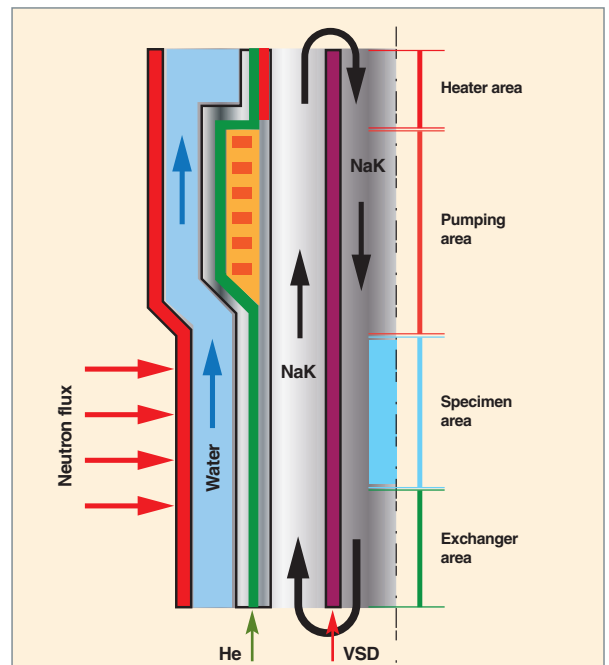

Fig. 103. The experimental device CALIPSO.

of needs expressed. Yet, as shown by first analyses, the development of technologies implemented for present devices may be, at least partially, deployed over devices dedicated to the other reactor systems, especially the main CALIPSO components (exchanger, electromagnetic pump).

A European project to investigate materials under irradiation

The European project “MTR+I3” (Integrated Infrastructure Initiative for Material Testing Reactor), launched within the framework of the 6th PCRD (Framework Program on Research and Technological Development), was aimed at establishing a durable cooperation between the European operators of irradiation reactors and related laboratories, in order to maintain the European leadership in the area of materials and fuels irradiations, and to prepare the setting up of new facilities, among which the JHR. This project gathered nearly all the European research institutes working in the nuclear energy development field (18 institutes accounting for 14 countries).

The technological developments conducted as part of this European project have encompassed areas as varied as studies on neutron shield performances, the design of devices such as gas coolant loops (and, particularly, the design of compressors, a key component of this type of facility), liquid metal loops (especially Pb-Bi), and devices simulating power transients in research reactors.

The European project also led to the design (and, for some of them, the achievement) of “fine” measuring systems in the field of materials subjected to stress and of online creep measuring, of out-of-fuel fission gas release detections, and of in-pile chemical water monitoring techniques.

Last but not least, the behavior of electronic equipment under irradiation could be tested.

An example of innovative development of a device for investigating creep under biaxial stress and under irradiation

During the normal operation of a light water reactor, fuel clads undergo variable and multi-axial thermo-mechanical stresses due to fuel rod environment and pellet-clad interactions. The modelling of fuel performances and safety assessments require reliable mechanical data on clad behavior, such as, for instance, thermal creep under irradiation of clads subjected to multi-axial stresses. This modelling is all the more complex as the cladding material (zirconium alloy) is highly anisotropic, given its hexagonal crystal lattice and the microstructure induced by the making process.

So, two innovative devices of a system for applying stresses on a clad sample, including deformation measuring, have been developed by the members of the network.

These devices are designed to apply controlled stress to the sample depending on uni-axial or bi-axial (or possibly variable) stress states, using pneumatic bellows. Progressive deformations of the sample are measured using linear differential probes (Linear Variable Differential Transformer, LVDT) with inductive sensor:

- The uni-axial device tests a clad section: a bellows system put inside the sample allows the latter to undergo a 300 N axial load through a 12 MPa pressurization;
- The bi-axial device uses a closed, pressurized clad section, which allows this section to be subjected to axial and radial stresses. In addition, it is equipped with external, pressurized bellows (to reach axial loads of about 2,500 N). Both pressures are controlled independently, which allows a fine control of the bi-axiality ratio σ_{ax}/σ_{rad} . Axial deformations are measured through a “LVDT” probe. A diameter deformation measuring through three contact points has also been investigated. The layout of this device is shown hereafter (fig. 104).

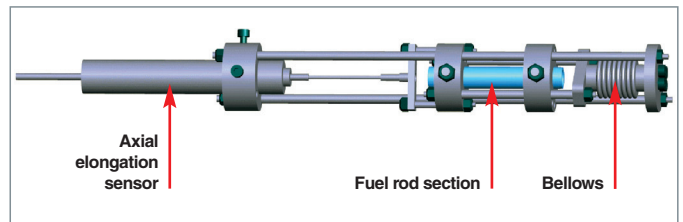

Fig. 104. Device for studying fuel rod sections under irradiation and stress.

Another application of this type of device was developed for investigating stress corrosion under irradiation of the stainless steels which the LWR core internals are made of (Irradiation Assisted Stress Corrosion Cracking – IASCC). The phenomenon includes a cracking initiation step and a cracking propagation step. The latter exhibits a deterministic behavior which has been broadly studied. This is the initiation step, less known, which is the main topic of the study. For this purpose, the corresponding stress corrosion test is to allow for the mechanical loading of the sample, and use an instrumentation likely to perform online measuring of deformations and of the cracking process, not to mention a precise control of the chemical composition of water.

Apart from the pneumatic-bellows loading system and LVDT-type displacement measuring systems, the device includes electrochemical measuring of noise in order to detect crack initiation, and specific electric measuring (potential drop method) to measure crack propagation (systems developed by PSI and the CEA). The loading and measuring systems developed are displayed on Figure 105. Additional electrochemical methods for controlling environmental (chemical) conditions have been developed by STUDSVIK, AEKI and UJV.

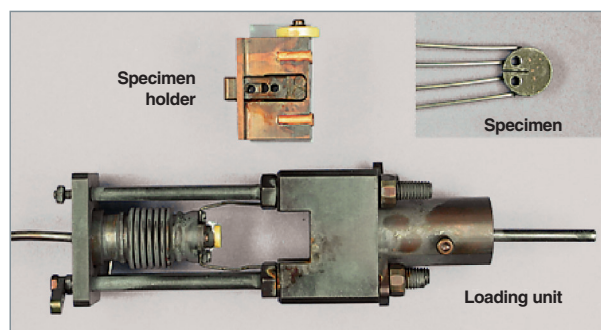

Fig. 105. Details of the equipment for investigating corrosion under irradiation and stress.

Christian GONNIER
Reactor Research Department
and Daniel IRACANE
JHR Program Director

Irradiating Materials with Ion Beams

When a neutron beam bombards a material, neutrons leave part of their kinetic energy to the target nuclei following almost merely elastic collisions. The damaging of the material then results from atomic displacements. The primary ions so generated will cause in turn new atomic displacements that will originate in the appearance of collision cascades and sub-cascades. These ballistic effects will induce an alteration in the irradiated material's microstructure. Besides, neutrons also generate nuclear reactions and transmutation reactions, which will generate new atoms: helium, hydrogen and transmutation products that will result in alterations of the irradiated material's chemical composition. Such alterations are likely to induce dimensional changes inside the material, and may affect its thermo-mechanical properties.

Simulating neutron irradiation with ion irradiation

All of these physical processes - atomic displacements, gas and secondary products generation, dimensional alterations; evolution of thermo-mechanical properties - may be simulated experimentally, basing on irradiations using ion beams in a single or multi-beam mode. For, when an ion beam bombards a material, incident ions will generate through elastic nuclear shocks **primarily knocked-on atoms** (or "PKA"), which in turn will increase the collision chain. Figure 106 shows the results relating to damage induced on iron respectively by neutron and ion beams.

These ballistic effects on atomic nuclei are accompanied by purely electronic effects such as excitations and ionizations. Respective contributions of nuclear interactions and electron interactions depend on the ion energy/mass ratio. To put it in a nutshell, nuclear slowing prevails for ions whose mass-related energy is between a few eV/nucleon and 50 keV/nucleon, with a maximum around one keV/nucleon. Electronic slowing prevails for energies larger than 1 MeV/nucleon. Within the energy range extending from a few dozens of keV/nucleon to a few hundreds of keV/nucleon, both processes intervene concomitantly, and control energy transfers.

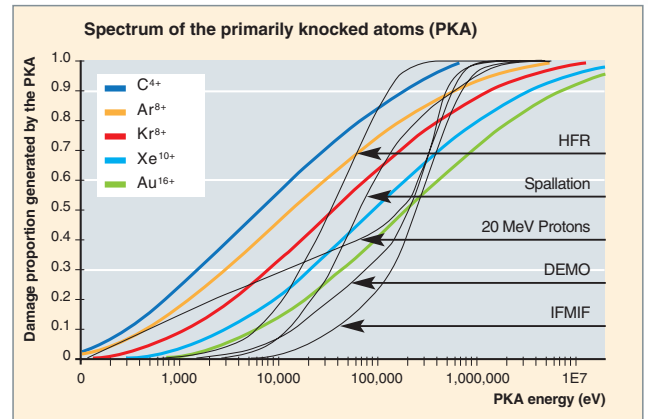

Fig. 106. Compared spectra of iron damaging by ions (curves in color) and by neutrons from various sources (curves in black).

So the simulation of neutron damaging in any material as well as the generation of new atoms can be achieved with one or several ion beams simultaneously bombarding the target [1, 2]. In contrast with neutron irradiations, ion irradiation exhibits a true flexibility in the choice of the irradiation configuration parameters, going from the total quantity of damage aimed to the irradiation temperature imposed to the material, including the control of the energy proportion deposited by electronic effect and by nuclear effect. This flexibility therefore allows for exhaustive parametric studies that would be impossible to conduct in a reactor. A certain number of *in situ* analytical diagnoses can be coupled to the irradiation containment. Besides, on account of the absence of ion activation of the irradiated samples, *ex situ* characterization can be programmed without delay. At the opposite, a few limitations exist regarding the representativeness of ion irradiations to simulate neutron irradiations. They chiefly result from the lesser penetration of ions into matter and the larger flux values (ion number.cm⁻².s⁻¹) to be reached. In the case of ion irradiation, the density of energy deposit will be much higher since the volume of the damaged material will be fairly lower. This difference will restrict the scope for post-irradiation measurements of physical and thermo-mechanical quantities on the macroscopic scale. Ion fluxes, much higher than neutron fluxes will induce secondary effects such as local gradients of temperature, the latter being likely to influence microstructure evolution (possible phase change) or the mobility of defects (recombining mechanisms).

Despite these restrictions, ion irradiation experiments are a powerful tool for investigating irradiation effects in solids, which completes neutron irradiation experiments, generally much heavier, longer and more costly. Of course, damaging mechanisms are not strictly identical for both types of projectiles, which prevents any direct transposition of the results. However, they are sufficiently close to deserve the same theoretical description.

For all these reasons, ion irradiation experiments are playing an increasingly significant role in studying materials under irradiation.

The JANNUS multi-ion beam platform

The design, installation and operation of the JANNUS multi-ion beam platform are intended to meet a threefold objective:

- Getting a tool likely to help validate experimentally atomic-scale simulation of nuclear materials behavior under irradiation;
- Being able to control physical and mechanical properties of solids through implantation/irradiation;
- Promote the teaching of ions/matter interactions and of nuclear science and technology.

The JANNUS¹⁴ platform is based on two experimental sites. The first is located at the Orsay University campus where it consists of the 2-MV Van de Graaff/Tandem accelerator ARAMIS and the 190-kV ion implanter IRMA, coupled with a 200-kV transmission electron microscope (TEM). This facility is managed by the French national Center for scientific research (CNRS: *Centre national de la recherche scientifique*). The second site is located at the Saclay Nuclear Research Center (CEA) and gathers three electrostatic ion accelerators: the 3-MV Pelletron™ ÉPIMÉTHÉE, the 2.5 MV single-stage Van de Graaff accelerator YVETTE, and the 2-MV tandem JAPET. The Pelletron™ is equipped with an electron cyclotron resonance (ECR) source of multicharged ions [3]. Figure 107 hereafter gives an insight of the ECR source performances in terms of multicharged ion production.

As regards the tandem, it is equipped with the caesium-sputtering charge-exchange ion source SNICS II (Source of Negative Ions by Caesium Sputtering).

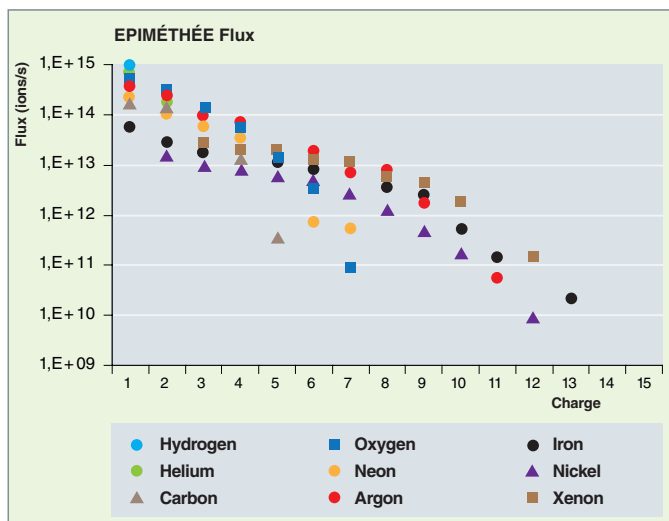

Fig. 107. Ion flux generated by the 3-MV ECR source of Pelletron™ depending on the charge state of the ion of interest.

Figure 108 below gives a schematic of the dual-beam facility + TEM of the Orsay site, while Figure 109 displays the space distribution of three accelerators of the Saclay facility JANNUS. The latter figure shows, first, the triple-beam experiment room in which the three beam lines respectively issued from the three accelerators converge, and, secondly, on the left side of the schematic, the ion-beam analytical line issues from the Van de Graaff YVETTE and, in the center, the single-beam irradiation line issued from ÉPIMÉTHÉE.

Figure 110 (next page) gathers four photographs which respectively display a) the ÉPIMÉTHÉE accelerator, b) the triggering of the bulb of the ion source YVETTE, c) the triple-beam room, and d) the tandem JAPET.

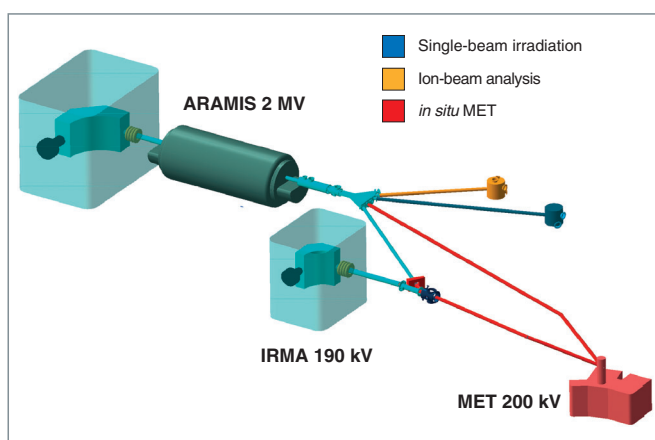

Fig. 108. Schematic description of the dual-beam facility + Transmission Electron Microscope of the Orsay JANNUS site.

14. JANNUS: a French acronym for *Jumelage d'Accélérateurs pour les Nanosciences, le Nucléaire et la Simulation*. Coupling of accelerators for nanosciences, nuclear engineering and simulation.

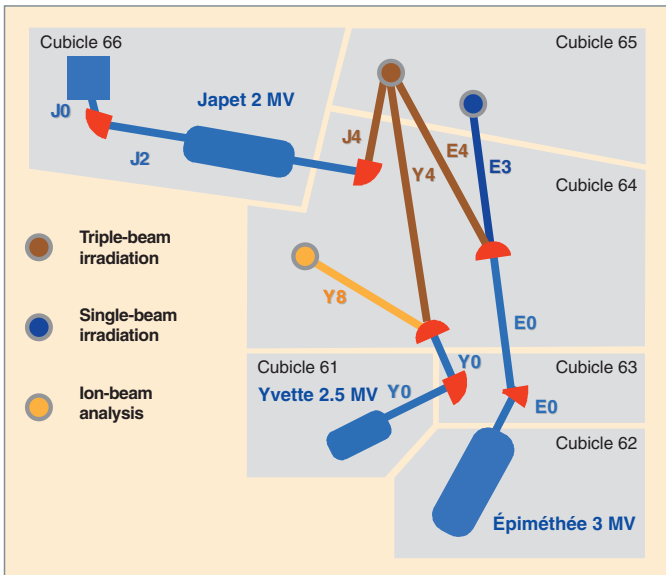

Fig. 109. Schematic of the whole triple-beam facility at the Saclay JANNUS site.

Research topics approached using the JANNUS platform

Among the major research topics in relation to the JANNUS platform, it is worth to mention the basic physics of ions/matter interactions, structural materials of water reactors (PWRs), present and advanced fuels, structural materials of Generation IV sodium-cooled fast reactors (SFRs) or gas-cooled fast reactors (GFRs), materials for fusion, confinement matrices of high-level radioactive waste, and inert matrices for long-lived radioelement transmutation. More precisely, the scientific issues raised in these various areas, to which ion irradiation experiments tend to give elements of response, are related with the following items:

- Water-reactor structural steels swelling;
- Helium bubble formation and growth mechanisms in ferritic steels;
- The damaging influence on the oxidation rate or stress corrosion kinetics of zirconium alloy clads;
- Atomic transport mechanisms such as, *e.g.*, oxygen spreading in uranium dioxide, xenon migration in transition metal carbides, or helium migration in alloys and composites;
- Irradiation-induced segregation and precipitation processes;
- Phase transitions in ceramics such as, *e.g.*, order-disorder transitions, partial amorphization of monazites or pyrochlores, or the polygonization of fluorite-structure compounds at high temperature;
- The microstructural stability, in strong fluence and high temperature conditions, of advanced materials for the reactors of the future, such as oxide-dispersion strengthened (ODS) alloys, carbide-dispersion strengthened (CDS) alloys or nitride-dispersion strengthened (NDS) alloys, silicon carbide SiC, or silicon carbide matrix and fiber composites,

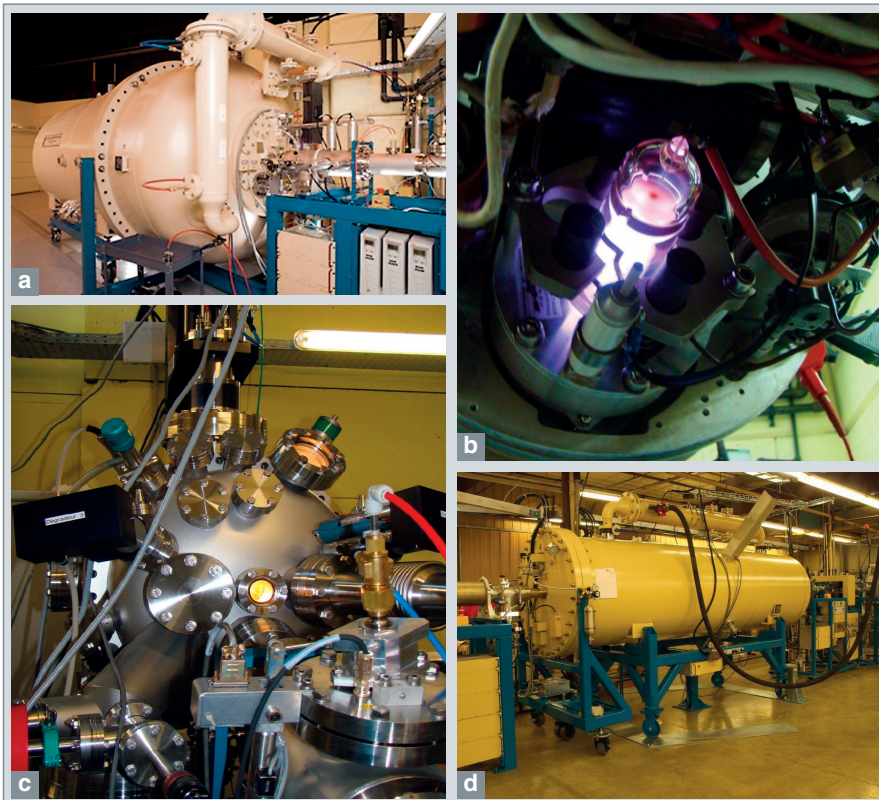

Fig. 110. Photographs respectively showing
a) the ÉPIMÉTHÉE accelerator,
b) the triggering of YVETTE ion source bulb,
c) the triple-beam chamber,
d) the JAPET tandem.

- The study of the effects of synergy between damage pile-up and gas generation (He and H) on the microstructural evolution of advanced ceramics and structural metal alloys (Fe or W) for fusion;
- The growth mechanisms of superficial flaws generated in nickel-base steels of PWR steam generator tubes, and their influence on the corrosion rate;
- Ionic mixing mechanisms in the neighboring of interfaces such as coating layers for advanced fuels or fusion materials designed to face the plasma;
- The controlled alteration of the mechanical, physical or chemical properties of components for optical, magnetic or microelectronic applications;
- The ion beam-assisted synthesis of new ceramic-type phases.

In parallel to these research works, instrumentation developments aim at designing around the irradiation facility something like a tool box, the latter gathering *in situ* or *ex situ* characterization techniques which enable experimentators to perform real-time assessments of damaging effects on their samples. In addition to *in-situ* transmission microscopy at Orsay or ion-beam analytical techniques accessible on both sites – such as Rutherford elastic BackScattering (**RBS***), ion channelling (RBS-c), elastic recoil spectrometry (ERDA), nuclear reaction analysis (NRA), and charged Particle-Induced X-ray Emission (**PIXE***) –, the utmost promising alternatives are provided by UV-visible emission spectrometry, **Raman*** spectrometry, X-ray diffraction, thermo-desorption, and **resistivity annealing***.

International ranking

There exists very few multi-ion-beam experimental facilities such as JANNUS in the world. Three of them are located in Japan (“Institute for Advanced Energy of Kyoto”, “Research Center for Nuclear Science of Tokyo”, and “Japan Atomic Energy Agency at Ibaraki”), and two in Germany (FZ Rossendorf and Iena University). Several projects have recently emerged, especially “Indira Gandhi Center for Atomic Research of Kalpakkam” (India), “*Centro de Investigaciones Energéticas, Medio-ambientales y Tecnológicas de Madrid*” (Spain) and “Lawrence Livermore National Laboratory (USA)”.

Silicon carbide irradiation with heavy ions

Owing to its refractory feature, its good mechanical strength and its good behavior under irradiation, silicon carbide is a potentially interesting material as a cladding or structural material for the nuclear reactors of the future. Two irradiation experiments were conducted on monocrystalline hexagonal silicon carbide 6H-SiC arising from two distinct supply sources. The first experiment consisted in irradiating samples from LETI on Orsay JANNUS with Au²⁺ ions of 4 MeV, and the second experiment, in irradiating samples from the CREE company on Saclay JANNUS with Ni⁺ ions of 0.92 MeV. In both cases, the dose reached is fairly higher than the amorphization threshold (about 0.5 dpa at room temperature [4]). All the data relating to these two irradiations are summarized in Table 12. After these two irradiations, Raman microspectrometry evidenced that crystalline SiC-coupled Raman peaks due to the breaking of Si-C bonds had completely vanished (fig.111). Reversely, new bands emerged, which accounted for disordered SiC and for homonuclear bonds Si-Si, and C-C at the

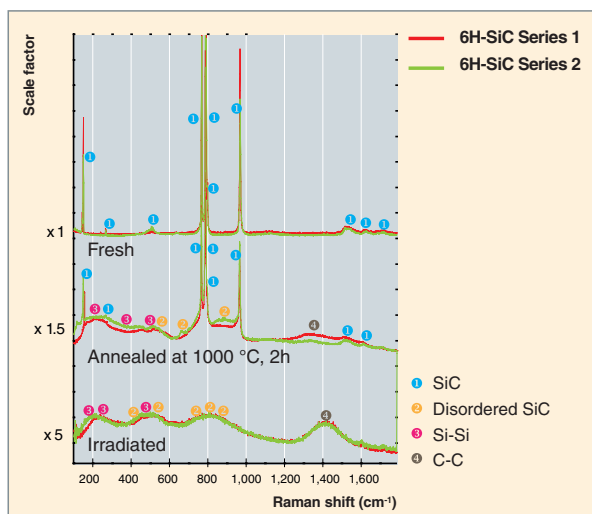

Fig. 111. Evolution under irradiation and annealing of Raman spectra obtained on 6H-SiC monocrystals arising from LETI (series 1) and CREE (series 2).

Table 12

Main data of SiC irradiation experiments both irradiations		
Sample	6H-SiC from LETI	6H-SiC from CREE
Ion	Au ²⁺	Ni ⁺
Energy	4 MeV	0.92 MeV
Fluence	10 ¹⁵ ions.cm ⁻²	1.54 x 10 ¹⁶ ions.cm ⁻²
R _p [*] (nm)	608	505
ΔRp [*] (nm)	92	120
(dE/dx) _e [*] (keV/μm)	3,691	1,029
(dE/dx) _n [*] (keV/μm)	2,726	624
dpa [*]	2.64	13.5

* Parameters calculated with the simulation code SRIM2008 [6].

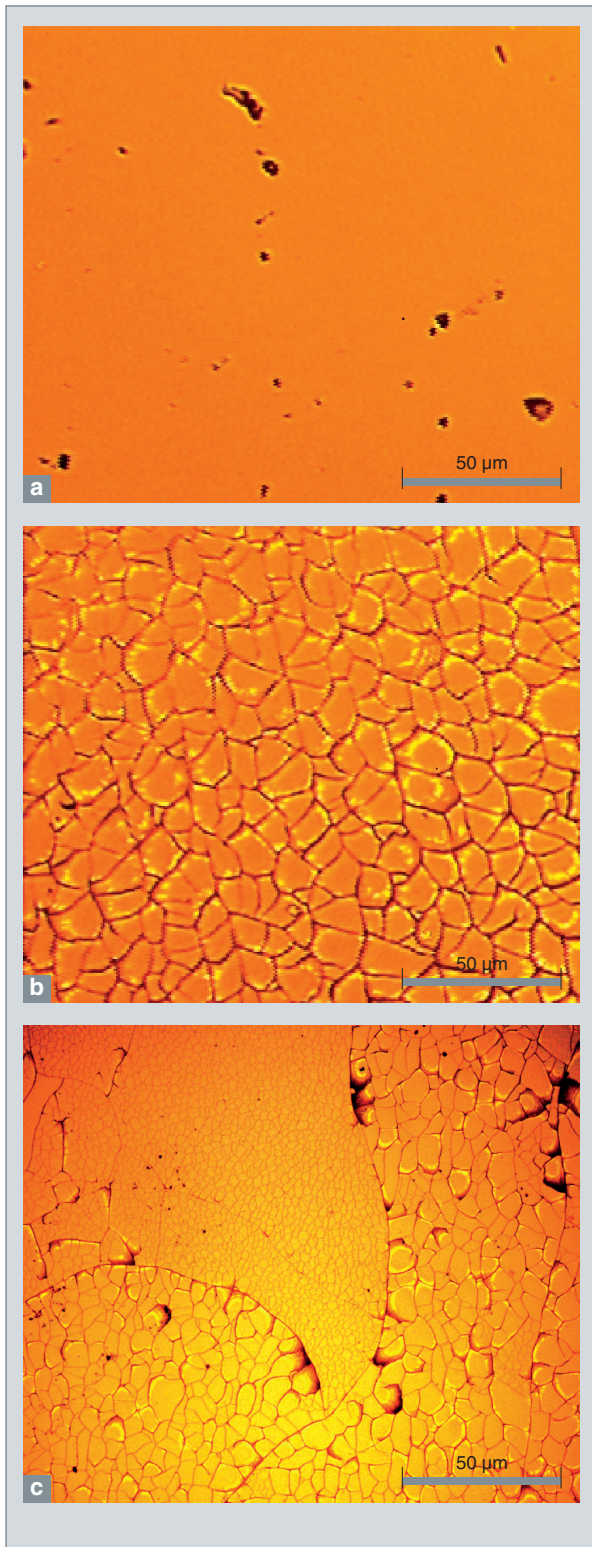

Fig. 112. Photographs taken by a polarized-light optical microscope a) of a 6H-SiC sample prior to annealing (the facies of the two fresh samples and of the two irradiated, unannealed samples are identical); b) of a sample of initially monocrystalline 6H-SiC irradiated by Au ions after annealing, c) of a sample of initially monocrystalline 6H-SiC irradiated by Ni ions after annealing.

level of secondary peaks [5]. Following a 1000 °C annealing for 2 hours (fig. 111), the crystalline 6H-SiC bands emerged again owing to the disappearance of interactions between phonons and irradiation defects, and to Si-C bond restoration. However, the bands corresponding with Si-Si and C-C homonuclear bonds are always present, and so the monocrystalline 6H-SiC was still incomplete. It is worth to mention that the spectra relating to the two samples were nearly identical prior to irradiation. They were still so after irradiation, and only exhibited slight differences after annealing. Moreover, after annealing, the appearance of many crystals could be observed, with a polarized-light optical microscope (fig. 112), on the surface of the two initially monocrystalline samples that had undergone two very different irradiations (table 12). So, the recrystallization of the amorphous area was achieved under a polycrystalline form in both cases. These two experiments are a perfect example of irradiations achieved on the two JANNUS sites and leading to very similar results, *i.e.* a **monocrystalline → amorphous phase transition after irradiation** of 6H-SiC monocrystals, and an **amorphous → polycrystalline transition phase after annealing** in the same crystalline system.

Patrick TROCELLIER, Sandrine MIRO, Jean-Marc COSTANTINI, Stéphanie SORIEUL, Lionel GOSMAIN
Nuclear Materials Department
and Pascal CHAIX
Innovation and Nuclear Support Division

► References

- [1] G.S. WAS *et al.*, "Emulation of neutron irradiation effects with protons: Validation of principle", *Journal of Nuclear Materials* **300**, pp. 198-216, 2002.
- [2] R.C. BIRTCHER, P. BALDO, "Use of ion beams to simulate reactions of reactor fuels with their cladding", *Nuclear Instruments and Methods in Physics Research B242*, pp. 487-489, 2006.
- [3] Y. SERRUYS *et al.*, "JANNUS : A multi-irradiation platform for experimental validation at the scale of atomistic modelling", *Journal of Nuclear Materials*, pp. 386-388 and 967-970, 2009.
- [4] S. SORIEUL, J.-M. COSTANTINI, L. GOSMAIN, L. THOMÉ and J.-J. GROB, *J. Phys.: Condens. Matter* **18** (2006), pp. 1-17.
- [5] W. J. WEBER, N. YU, L.M. WANG, N.J. HESS, *J. Nucl. Mater.* **244** (1997) pp. 258-265.
- [6] J.F. ZIEGLER, J.P. BIRSACK, et U. LITTMARK, "The Stopping and Ranges of Ions in Solids", vol. 1, Pergamon, New York, 1985 ; <http://www.srim.org/>.

► Bibliography

Comptes Rendus Physique **9**, 2008, Special Issue devoted to research on the behavior of materials subjected to fast neutron irradiation.

Investigating Accident Situations

Research reactors constitute privileged equipment to investigate nuclear fuel behavior under accidental conditions. Generally speaking, these accident regimes result from an unbalance between power produced by fuel and power released by **coolant***.

The whole of these situations may be gathered in two accident categories, which differ in their evolution and their impact on fuel behavior: the **loss of cooling accident***, including the **Loss Of Coolant Accident* (LOCA*)**, and the **Reactivity-Initiated Accident* (RIA)**.

These accidents are the so-called “Category-4” operating accidents, whose probability of occurrence ranges from 10^{-4} to 10^{-6} by reactor and by year. In the case of a failure of protection and safeguard systems, another accident category is then concerned, named **severe accident***, characterized by extended core destruction and melting, and associated with a high radioactivity emission, which will have to be maintained inside the reactor containment.

Regarding the first two categories (loss of cooling accidents and reactivity-initiated accidents), the safety approach has led to determining physical state and fuel behavior criteria to be complied with in any situation in order to make sure that the reactor core is maintained in a safe state and, particularly, can be cooled.

The aim of experiments conducted in an research reactor is then to simulate such accidents so as to validate the coherence of these criteria with respect to the whole of possible situations, as well as their applicability to fuel evolutions, such as increased burn-ups or the introduction of new fissile materials (MOX, doped fuels...) or new cladding materials (new zirconium alloys). This simulation may be achieved on a smaller scale, on a rod or rod assembly, or explore the influence of some parameters in order to improve understanding of the physical phenomena involved.

As regards severe accidents, studies performed in experimental reactors or high activity laboratories aim at improving understanding of complex physical phenomena of fuel degradation, and of the related fission products release, so that efficient means may be implemented to mitigate such accidents.

Loss of cooling accident

This type of accident results from a loss of core cooling. These are accidents featuring a relatively slow kinetics that may last from a dozen minutes to several hours.

For instance, concerning pressurized water reactors, the loss of coolant accident (LOCA) is considered to be the envelope accident of this reactor category: it results from the guillotine break of a main coolant pipe of the primary circuit, which induces the depressurization of this circuit, thereby leading to water vaporization. Despite the fission reactions are stopped

due to the **void effect*** on the **moderator*** and the **control rod*** drop, the fuel in the core goes on heating under the effect of **residual power*** resulting from fission products decay. It is then crucial to discharge this energy through immediate implementation of the emergency water injection system.

From loss of coolant to reflooding and core cooling, thermal-hydraulic conditions of fuel are to evolve according to the following stages, summarized below on Figure 113:

- **Decompression stage and fast ramp in temperature.**

Clad temperature quickly increases during a few dozens of seconds, with a kinetics of several dozens of °C/s. During the same time, as a consequence of the primary coolant system depressurization, the clad is subjected to an internal pressure due to filling helium and to the additional release of fission gases, which may induce a local ballooning restricting the water inlet section through the assembly. In the case of strong ballooning, this may entail a fissile column shrinkage, together with a relocalization of fuel fragments, which then alters the axial power gradient in the rod, and may lead to a local hot spot, and even to a risk or new criticality. Furthermore, the clad may be broken during this initial stage: in this case, part of the radioactive products inventory available in the rod is released into the primary circuit. These are mainly rare gases, xenon and krypton;

- **Temperature level under steam.** A temperature level is then established between 900 and 1200 °C, depending on the rods, and lasts several dozens of seconds. These conditions accelerate the outer oxidation of the clad by steam, an exothermic reaction that entails zirconia formation and hydrogen generation:

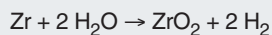

- **Reflooding under water and final core cooling.** The sharp cooling of rods takes place during core reflooding by emergency cooling systems. During this final stage, the clad, embrittled by oxidation, may happen to be broken under the effect of thermal quench shock, inducing an additional release of radioactive fission products by “washout”: rare gases, but also volatile fission products, such as iodine, caesium and tellurium. Fine fuel debris may also be transported into the primary coolant system;

- **Post-accident management:** the handling of fuel assemblies is to be performed without any further risk of rod failure.

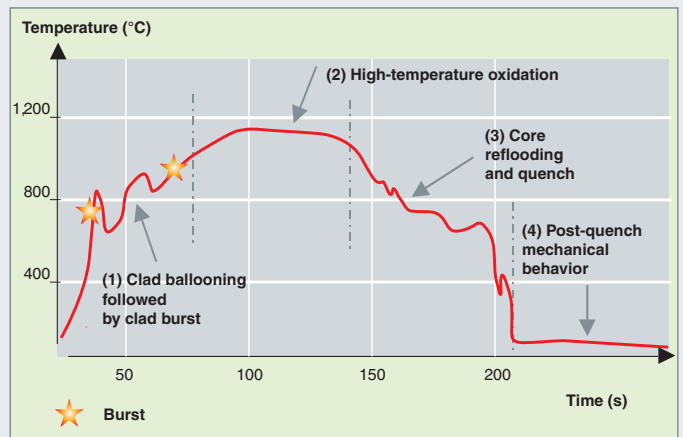

Fig. 113. Schematic of a clad temperature transient during a loss of coolant accident. Consequences on fuel clad behavior.

In order to reduce the risks of clad failure after a high-temperature oxidation phase, and to tend to preserve rod geometry at best for the core to be allowed to cool down, it was determined that fuel should comply with the following two criteria:

- Clad temperature shall not exceed 1,200 °C;
- Clad oxidation rate shall not exceed 17 % of its initial thickness after a possible ballooning.

These criteria avoid the runaway of the reaction under the effect of temperature, and so limit clad oxidation rate, the aim of which is preserving a sufficient ductility of clad to ensure its integrity during reflooding. These criteria were established in 1973 basing on analytical tests with a fresh or slightly pre-oxidized zircaloy-4 clad. They were validated by a number of programs conducted in out-of-pile facilities and in a few research reactors. In particular, it is worth mentioning CEA’s PHÉBUS-LOCA program conducted on a 25 fresh rod assembly (see the chapter on “The PHÉBUS Research Reactor for Studying Loss of Coolant Accidents”, pp. 123-126).

Developing new fuel materials requires the updating of these criteria, which are no longer adapted to high-burnup fuels and to some highly pre-hydrated clads. A privileged experimental support for such studies is provided by both the JHR (see below, pp. 131-132, the chapter on “Outlooks for Research on Accident Situations with the Jules Horowitz Reactor”) and the PHÉBUS reactor at the CEA Cadarache (see below, pp. 123-126, the chapter on “The PHÉBUS Research Reactor for Studying Loss of Coolant Accidents”).

Reactivity-Initiated Accident

As shown by its name, the Reactivity-Initiated (or Insertion) Accident (RIA) results from a **reactivity*** insertion into the core. In contrast with LOCA, its kinetics is very high, hence high constraints for reactor design basis.

Concerning pressurized water reactors, the LOCA may result from the ejection of a **control rod***, following failure and the related depressurization of its support mechanism. Another mode of reactivity insertion may be issued from an accidental dilution of borated water in the primary coolant system by non-borated water. Regarding sodium-cooled fast neutron reactors, the two types of LOCA and reactivity-initiated accidents are closely connected owing to the positive void coefficient of sodium. Thus, the plugging of a sodium coolant channel induces an instantaneous increase in core reactivity, compensated then by a neutron feedback called **Doppler Effect***, which counterbalances power excursion when fuel temperature increases.

The ejection of a control rod in a pressurized water reactor induces a quasi-instantaneous power transient, with a significant energy deposit on the fuel rods located in the neighboring of the ejected rod (fig. 114).

The first accident stage, induced by the action of fission **prompt neutrons***, extends over a few dozen milliseconds. It is characterized by a strong mechanical interaction between fuel and clad due to the volume expansion of oxide induced by the quasi-adiabatic heating, as well as the pressure applied by fission gases. In case of clad failure during this initial phase, a fuel dispersion as small fragments may lead to the sharp vaporization of the water surrounding the rod, with a risk of

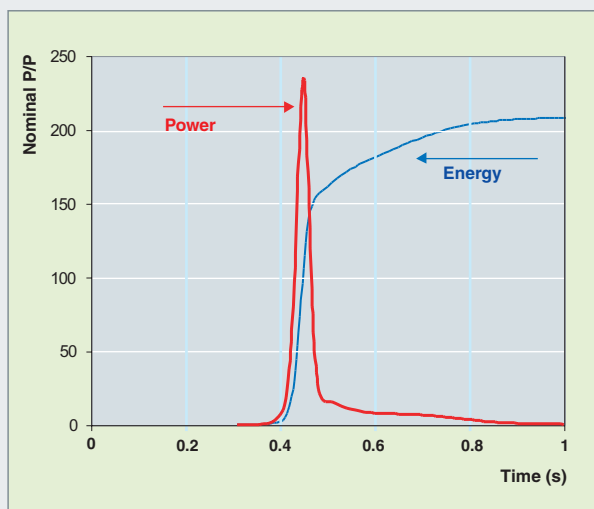

Fig. 114. Evolution versus time of power and injected energy during a reactivity-initiated accident.

steam explosion and degradation of the neighboring rods. The **chain reaction*** then stops spontaneously due to fuel internal heating and the Doppler effect.

The second accident stage, governed by the thermal evolution of the system, ranges from a few seconds to a dozen seconds. It leads to a strong rise of clad temperature, hence the risk to reach **boiling crisis*** in the surrounding water channel, and to a maintained strong internal pressure of the rod which, still, may affect clad integrity.

Concerning water-cooled reactors, present safety criteria relating with this accident were established in the early 1980s, basing on experiments achieved in the United States (SPERT and PBF Programs), and then in Japan (NSSR Program), on fresh or slightly irradiated fuel (up to 30 GWd/tU). These criteria aim at ensuring fuel non-dispersion and defining a threshold value of average enthalpy deposited in fuel, not to be exceeded during the transient (230 cal/g for fresh fuel and 200 cal/g for irradiated fuel). The issue at stake is to make sure at one and the same time that there is no significant release of mechanical energy, the core is cooled, and any risk of steam explosion is avoided.

Similarly to the LOCA, validating these criteria requires the implementation of large-scale experimental programs. Most of them are conducted in dedicated research reactors, such as the CEA's CABRI reactor (see below, pp. 119-122, the chapter on "The CABRI Research Reactor for Studying Reactivity-Initiated Accidents").

Thus, this reactor was used from 1978 to 2001 to investigate the reactivity-initiated accidents of sodium-cooled fast neutron reactors on single fuel rods, in addition to the studies conducted with the SCARABÉE reactor from 1983 to 1989, which allowed test to be performed on assemblies of up to 37 pins. CABRI was then used for the PWR reactor system, from 1993 to 2000, to achieve tests simulating the first accident stage, during which a strong pellet-clad mechanical interaction occurs with no significant internal heating of the clad. The advanced stage of the transient, under conditions representative of the reactor (clad internal heating, high internal pressure), will be studied through the CIP Program (CIP: Cabri International Program): this program was launched by IRSN in the pressurized water loop of the reactor, as part of a large-scale international cooperation conducted under the auspices of the OECD, and in a strong collaboration with EDF.

Last but not least, the SILENE-RIA program considered for CEA/Valduc pulsed reactor is an analytical program designed to quantify the dynamical effect of fission gas release in an RIA on thermo-mechanical clad loading (see below, pp. 127-129, the chapter on "The SILENE Reactor for Studying Criticality Accidents").

Severe accident

A severe accident is in fact the consequence of one of the two types of accidents mentioned above, in which the protection and safety systems have experienced a failure. Though of a very low probability of occurrence, such accidents did take place. In the past, in the three major accidents experienced by the nuclear industry, the postulated initiating event was a loss of cooling for the Three Mile Island accident in 1979 and the Fukushima accident in 2011, and a reactivity excursion for the Tchernobyl accident in 1986.

In such an accident and contrary to those previously mentioned, the aim is no longer to maintain a “coolable” core geometry, but to limit fuel melting and the potential radiological consequences through implementing the so-called “ultimate procedures”. As regards French pressurized water reactors, we can mention as an example the U5 procedure for the deliberate containment depressurization with controlled filtration of radioactive releases (filtered containment venting), which is designed to avoid containment failure in case of overpressurization.

The progression of a severe accident in a water-cooled reactor can be described as follows:

- Following the discharge of the primary coolant system and core deflooding, the fuel heats under the effect of residual power released by fission products (FPs) contained in it; the core is degraded to the formation of mixed molten materials, called **corium*** ($\text{UO}_2 + \text{ZrO}_2 +$ structural core materials), likely to reach 3,000 °C. The corium flows through the core, and is relocalized in the bottom of the vessel, which in turn is heated by the corium;
- During the stage of core degradation, FPs are released by fuel rods, first fission gases and volatile FPs (iodine, caesium, tellurium), and then a fraction of little volatile FPs and **actinides***;
- Aerosols formed and FP vapors are carried over by the hydrogen-enriched steam flow to the primary coolant system, and reach the containment. They may be partially deposited, and be resuspended later on;
- Part of FPs may then leave the containment through various paths, under the form of aerosols or gases, and induce a radioactive contamination of the environment: this is the “source term” taken into account by the safety authorities for the design basis of emergency plans. Among these FPs, iodine plays a prominent role in relation to radiological consequences owing to its high activity level in the days following the accident, its high volatility, and its ability to form gaseous species such as molecular iodine or organic iodine.

Two main experiment categories allow the source term of a severe accident to be characterized: analytical experiments conducted in a high-activity laboratory, and integral tests conducted in a research reactor.

Analytical experiments consist in heating a short rod section in an environment selected as the closest to that to be met in a severe accident, and measuring released FPs on line or after tests. Their main interest is to be able to pinpoint the various physical phenomena involved for the purpose of understanding basic mechanisms. Let us mention, for instance, in this category the VERCORS program conducted at the CEA/Grenoble from 1983 to 2002, and the succeeding program VERDON, to be launched in 2011 at the CEA/Cadarache.

Integral tests are tests on a larger scale, generally conducted on an assembly of several rods introduced in the center of a research reactor, which allow the phenomena related with core degradation to be investigated. Another interest of these tests is studying, through a dedicated experimental loop connected to the in-core circuit, the whole of physical phenomena relating to FPs transport in the primary coolant system, and their long-term behavior in the containment. This is best illustrated by the PHÉBUS-PF Program, conducted in the CEA’s PHÉBUS reactor from 1993 to 2004 (see below, pp. 123-126, the chapter on “The PHÉBUS Research Reactor for Studying Loss of Coolant Accidents”), in relation to PWRs, and by the SCARABÉE Program, in relation to SFRs.

Gérard DUCROS
Fuel Studies Department

The CABRI Research Reactor for Studying Reactivity-Initiated Accidents

Objectives of the CABRI reactor, and facility description

The CABRI research reactor was built in 1962 at the CEA/Cadarache to study the response of nuclear fuels to a power excursion. These power “jumps”, as evoked by the reactor name, are the direct consequence of a **Reactivity-Initiated Accident***. This reactor belongs to the category of safety test reactors. At the present time, the CEA conducts in it R&D programs defined and steered by the IRSN within the framework of national and international collaborations.

Since its construction, the CABRI research reactor has been adapted to meet the needs of safety studies and the French nuclear fleet constitution. When it was built, CABRI was a water-cooled irradiation research reactor consisting of plate fuel elements. In 1975, this facility underwent a core reconfiguration and was completed with a central sodium loop, which has made it possible to achieve tests adapted to sodium-cooled reactors of the fast neutron reactor system for about thirty years. As early as 1993, tests were also achieved, in a first stage, on fuel rods of the PWR system reactors in the sodium loop. The need for a more complete simulation of PWR cooling conditions, and, especially, for studies of fuel/water interaction in the case of rod failure, has led to retrofit the facility so as to insert there a pressurized water test loop in replacement of the sodium loop. In parallel, refurbishment works (mechanical upgrading, civil engineering and fire protection) have been undertaken.

This research reactor is a pool-type reactor which today consists of a core made of uranium oxide (UO_2) based fuel, with a power limited to 25 MW in steady operation, and cooled by a water circuit (fig. 115).

The reactor core, of a reduced size (65 cm wide and 80 cm high), consists of 40 fuel rod assemblies designed to withstand fast power variations during tests. For this purpose, the fuel clad of the driver core is steel-made. The core is fitted in its center with a vertical cavity designed to house the test device containing the fuel sample to be tested, and horizontally, with a channel sheltering a device called a “hodoscope”, *i.e.* a measuring system designed to display in real time the deformations and motions of the tested fuel through detecting the fast neutrons it emits. The cooling of the driver core is ensured either by natural convection with the reactor vessel water, or by forced convection with the coolant system.

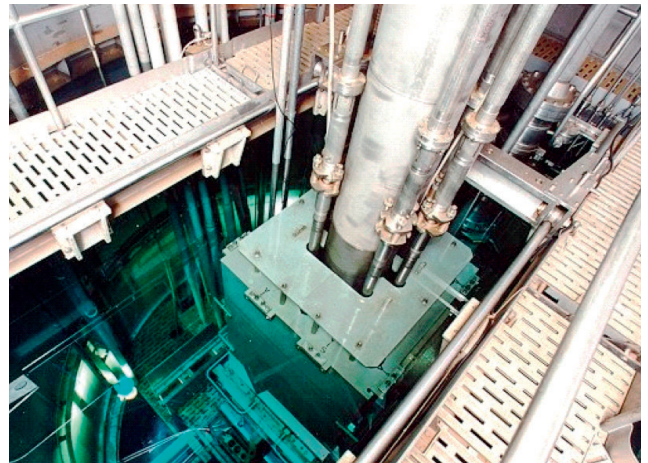

Fig. 115. The CABRI reactor: topview of the core in the pool and of the test loop going through the core vertically.

Apart from the 6 control and safety rods, the reactor is fitted with 4 specific rods filled with pressurized helium 3 (a neutron-absorbing gas) which are used to achieve a fast power transient through depressurization. The **Doppler*** effect limits the duration of power excursion to a few milliseconds, but instantaneous power during the transient may reach up to 20,000 MW...!

The test loop (fig. 116) is a device which allows a fluid to flow in a closed circuit in the reactor core. It consists of three elements:

- An in-pile cell located in the central cavity of the reactor core, designed to house the test device and the fuel pin or rod to be tested;
- A cell containing the experimental circuits which are used to reach the thermo-hydraulic conditions of interest;
- Interconnection piping and circuits for collecting liquid and gaseous waste generated by tests.

The test loop makes it possible to reproduce the same conditions of temperature, pressure and flow velocity for the fluid surrounding the test fuel, than those prevailing in the core of an industrial reactor.

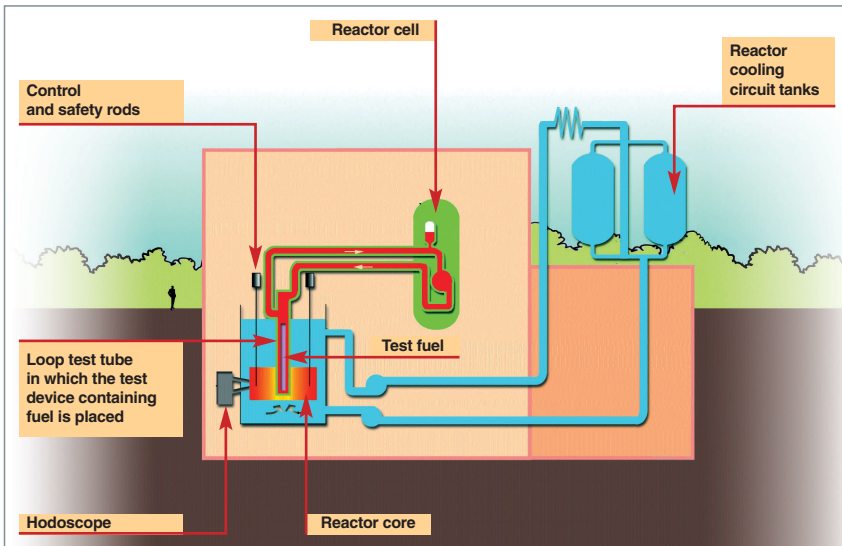

Fig. 116. The CABRI reactor: schematic of the water test loop (green). It consists of the cell designed to reproduce the thermohydraulic conditions required during tests, and of the tube through which the test device can be placed at the core of the reactor.

Tests in CABRI

In the first stage between 1962 and 1968, CABRI was used to investigate reactivity-initiated accidents of experimental reactor plate fuels as well as overpower limits on various types of cores.

In a second stage from 1968 to 1977, the facility was equipped with the sodium experimental loop designed to investigate the behavior of the fast neutron reactor fuel during a loss of flow accident leading to reactivity insertion and core melting (Containment Design Basis Accident selected for SUPERPHÉNIX).

Four main programs were conducted on the fast neutron reactor fuel between 1978 and 2001, *i.e.* 59 tests. The various mechanisms of clad failure, the contribution of fission gases to the mechanical fuel/clad interaction, and the phenomena resulting from pin failure could be so evidenced. The incidence of various parameters was assessed, such as fuel type, **burnup*** and the level of energy deposited.

In particular, these tests helped validate the computer codes used for safety studies, and, more generally, contributed to a better understanding of the behavior of fast neutron reactor fuels during accidents.

Although the PWR¹⁵ coolant is water, the sodium loop of the CABRI facility has also been used to simulate reactivity-initiated accidents in this type of reactor. For it allows the thermo-mechanical behavior of a rod in the first step of the accident

(without any significant clad heating) to be simulated under satisfactory conditions. The first tests of this type were achieved in 1993 as part of the PWR-Na Program to be continued till 2000. Twelve tests have been performed till today, among which 8 for uranium oxide (UO₂) fuel, and 4 for mixed oxide fuel (MOX fuel).

Power transients in these tests leave an energy of about one hundred J/g in the fuel rod, which is sufficient to try the rod intensively: given the extreme shortness of the transient, of about one dozen milliseconds (fig. 117); thermal gradients in the rod are fairly high and may generate thermo-mechanical effects sufficient to entail clad failure.

During these PWR-Na tests, temperature sensors are placed in and on the rod, as well as in the coolant. Diametral and longitudinal deformations of the rod, as well as fission gas release in the coolant following any clad failure, are also measured. Rods are examined post mortem: clad failures are observed as soon as the level of energy deposited by the transient in the fuel exceeds a few dozens of J/g. Failures take place mostly if the fuel rod has already experienced a significant irradiation before the transient. Its clad is then embrittled by oxidation and associated hydriding (fig. 118). A decohesion of ceramic grains by fission gas expansion can also be observed.

All of these observations were confronted with the predictions of the SCANAIR code, which calculates the system's thermal features (temperature evolution versus time in rod and coolant) (fig. 119), the mechanical behavior of the rod (elastic and plastic deformations) (fig. 120), and the amount of fission gases

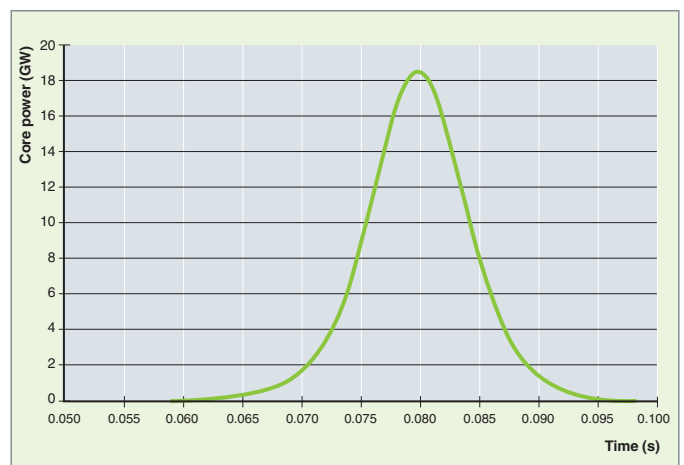

Fig. 117. A typical power transient in the CABRI reactor.

15. PWR: Pressurized Water Reactor.

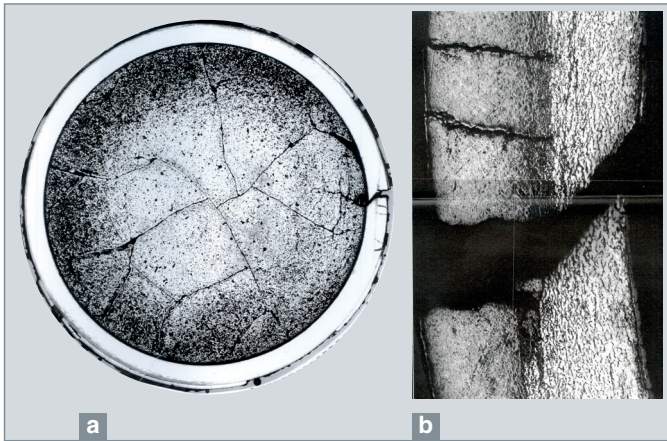

Fig. 118. Cutaway view of a failed fuel rod during a PWR-Na test in the CABRI Reactor. The fuel was pre-irradiated prior to the test up to a 60 GW.d.t⁻¹ burn-up, hence the fracturing of the fuel ceramic (a), as well as clad oxidation and hydriding (a, b).

released out of the ceramic. There is a good theory-experiment agreement on the first two observable values. In contrast, the results are a little less satisfactory for fission gases, but it is true that the phenomenology of fission gas release in a polycrystalline ceramic is complex, indeed...

Thanks to those tests, the resistance margins of the PWR fuel with respect to a power transient could be better determined. However, the PWR-Na Program has not allowed the reactivity-initiated accident to be studied in its whole owing to the lack of coolant representativeness, especially as regards the fuel-coolant interaction after clad failure.

In 2002, two tests of the CIP Program (CIP: Cabri International Program) were performed in the sodium loop, and thus

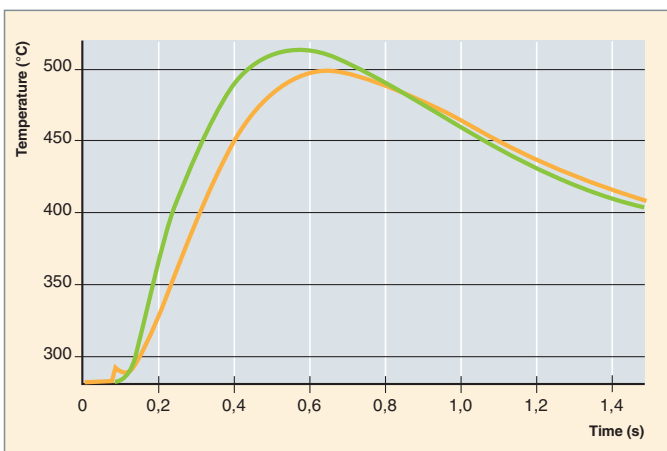

Fig. 119. The temperature transient on the outer face of the fuel rod measured during a PWR-Na test in the CABRI reactor. Comparison with calculation (green curve = SCANAIR code developed at the CEA).

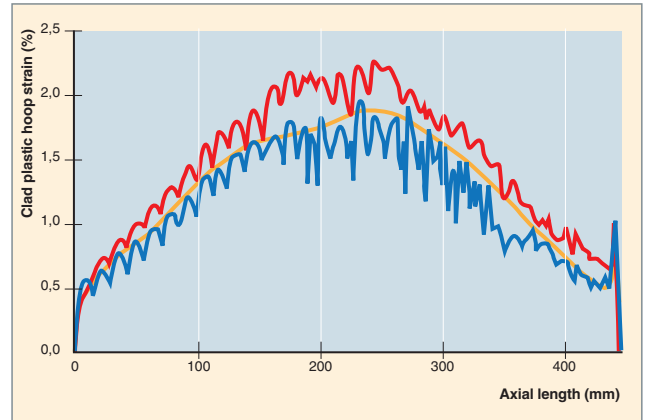

Fig. 120. Plastic hoop strain of a fuel rod during a PWR-Na test in the CABRI reactor. Comparison with calculation (orange = SCANAIR code developed at the CEA).

allowed two high burn-up (75 GW-d/t) PWR rods to be tested prior to the reactor shutdown before retrofitting and installation of the pressurized water loop.

Future experiments in CABRI

The facility upgrade undertaken in 2003 was intended to achieve tests in thermo-hydraulic conditions representative of PWRs (155 bar and 300 °C), and to bring further knowledge on fuel rod behavior during reference (design basis) accidents for the safety tests of industrial reactors: the **Reactivity-Initiated Accident*** (RIA*) and the **Loss of Coolant Accident*** (LOCA*).

Thus, as part of the first program scheduled in CABRI with a pressurized water experimental loop (CIP framework) and steered by IRSN, a dozen tests are to help investigate the behavior of high burn-up UO₂ fuels in RIA conditions, as well as MOX fuels in relation to the future management of PWR fuel.

Beyond the CIP Program, other programs dedicated to investigating PWR fuel behavior are under definition, regarding additional studies in RIA conditions and tests in LOCA conditions. LOCA-type tests could help study fuel and clad behavior during the main accident steps (temperature rise in fuel, high oxidation of clad, rod **quench*** resulting from reflooding...).

Last but not least, IRSN and CEA are considering the possibility to achieve further CABRI tests as a support to the safety analysis of future sodium-cooled fast neutron reactors.

Jérôme ESTRADÉ,
Reactor Research Department

The PHÉBUS Research Reactor for Studying Loss of Coolant Accidents

Objectives of the PHÉBUS reactor, and facility description

The PHÉBUS research reactor is a research reactor built in 1977 at the Cadarache research center. It was designed to investigate NPP fuel behavior in accidental situations such as LOCAs that can go to fuel melting. The main issue at stake in relation to studies of loss of coolant accidents in power reactors is that of fuel degradation and its consequences: from which temperature, after how much time does clad failure or, even worse, core melting take place? What is the fission products release associated with these two phenomena?

The PHÉBUS reactor belongs to the category of safety test reactors. The IRSN¹⁶ (French radiation protection and nuclear safety institute) is the main customer of the studies conducted on this reactor within the framework of an international collaboration. On its own part, the CEA is the operator of this tool, which is unique in the world indeed.

PHÉBUS is a pool-type research reactor, the core of which includes 1816 ²³⁵U low-enriched UO₂ rods. It is cooled and **moderated*** with water. Its maximum thermal power allowed is 38 MW. The reactor power control is carried out using 6 **control rods*** and safety rods (fig. 121).

16. IRSN: a French acronym for *Institut de Radioprotection et de Sécurité Nucléaire*, the French radiation protection and nuclear safety institute.

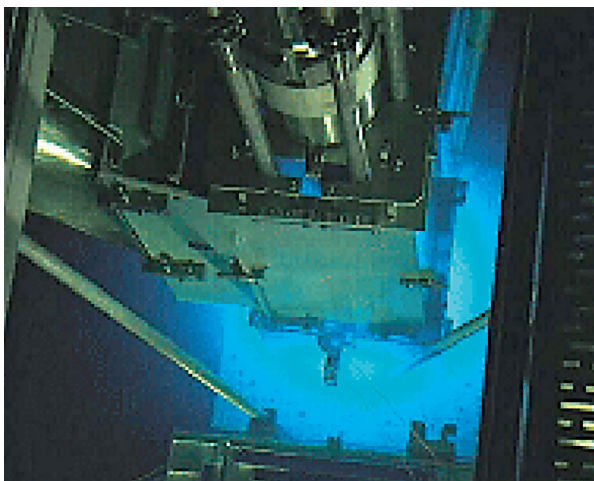

Fig. 121. The core of the PHÉBUS reactor under operation.

The core is crossed in its center by an in-pile cell that may contain a test **fuel assembly*** (this assembly consists of a maximum of 20 rods, either fresh or already irradiated in a nuclear power station). The cooling system of this cell is a pressurized water loop which allows thermal and chemical conditioning of water in the neighborhood of the test fuel. This cooling system is independent of that of the reactor, which makes it possible to simulate a loss of cooling on a few fuel rods while still preserving a nominal cooling for the rest of the core.

The so-called in-pile cell consists of two concentric tubes which go across the driver core. The inner tube, the so-called pressure tube, is made out of inconel, and the outer tube, the so-called safety tube, is zircaloy-made. The space between both tubes is kept under vacuum in order to ensure thermal insulation of the pressure tube from the driver core cooling water.

In 1990, the facility was deeply upgraded in order to carry out the PHÉBUS PF program dedicated to fuel tests in severe accident conditions, which was designed to validate computer codes implemented to predict fission products release by core fuel elements and their behavior in the reactor **coolant system***, the **steam generator*** and the **containment*** (see fig. 122 on the following page). This program is conducted in conditions representative of those of a pressurized water reactor as regards both the source of fission products, and the conditions FPs meet during their progression as well as the series of successive phenomena occurring during a severe accident. For this purpose, a metallic vessel named "FP vessel" (fig. 123) was built as an extension of the main facility. Experimental circuits have been installed so as to collect fission products issued from test fuel melting, and mimic their path in a power reactor through the fuel **clad***, the **reactor vessel***, the **steam generator*** and even the containment. They mainly consist of:

- An FPs outlet line which brings fission products from the test device to the storage tanks;
- A steam generator consisting of a single loop;
- A tank which mimics a PWR containment on a 1/5,000th scale, and is designed to house fission products.

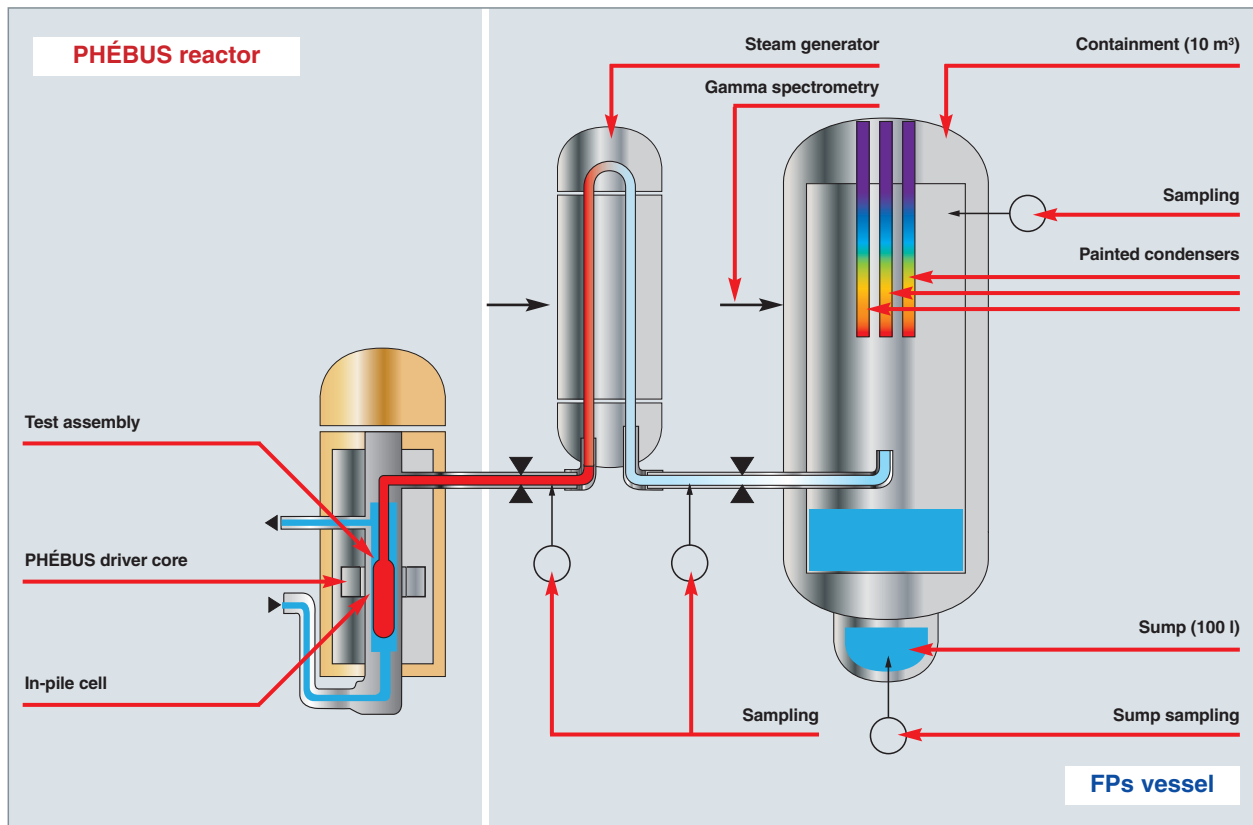

Fig. 122. Principle schematic of the PHÉBUS reactor and its experimental circuits.

Tests in PHÉBUS

From July 1982 to December 1984, six tests were carried out for the first part of the PHÉBUS program, PHÉBUS LOCA* (an acronym for Loss Of Coolant Accident).

The objective of this program was the study of a PWR fuel behavior in loss of coolant situations which corresponded with an accident situation following operation in nominal conditions. This accident was followed with the implementation of emer-

gency cooling. The phenomena investigated were related with the PWR reference accident, which does not evolve to core melting.

There were two objectives: assessing margins with respect to the two main criteria selected as part of the reactor design basis, *i.e.* maximum temperature and maximum oxidation of clads, and validating the fuel behavior codes used in safety analysis, especially, the fuel module of the computer code CATHARE* (developed by the CEA). The whole of the experimental program was conducted using fresh fuel. The maximum temperature reached was 1,300 °C.

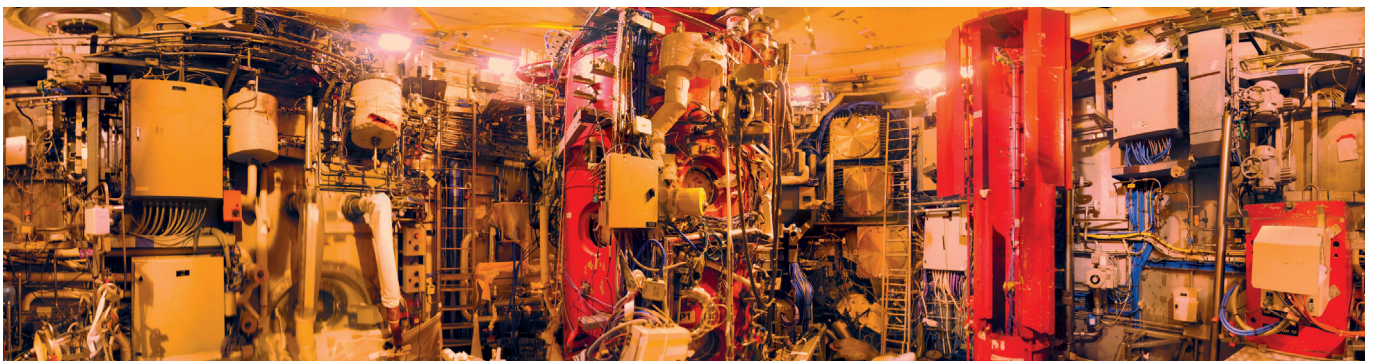

Fig. 123. General view of the FPs vessel.

The PHEBUS CSD¹⁷ program, conducted between 1986 and 1989, included 6 tests. The aim of the program was investigating the PWR fuel behavior in accidental, but beyond-design-basis situations, the so-called “severe accident”. Thus, the program was focused on the study of fuel degradation at a temperature level higher than the temperature corresponding with the PWR design basis criterion, and lower than the uranium oxide melting temperature. This program was used in the validation of the ICARE-1 code models, especially as regards the phenomenology of clad oxidation. This knowledge is used today in the safety analysis of severe PWR accidents.

The PHEBUS PF¹⁸ program, conducted between 1993 and 2004 after the facility was upgraded, was focused on the phenomena prevailing in the evolution of the state of a PWR, assumed to be in a severe accidental situation. The situations considered postulated the total or partial failure of the protection and safety systems of the core. They also assumed the failure of the operative procedures used to avoid core melting or limit its radiological consequences.

The program exhibited two features:

- Studying phenomena which determine core degradation, core melting and then the solidification of components;
- Studying the evolution of fission products, under the form of steam or aerosols, from the release of these products by fuel to their dissemination into the atmosphere. This step includes the study of active products transport and deposition in the reactor primary and secondary coolant systems, and of the physico-chemical evolution of these products in the containment.

This experimental program made it possible to validate the computer codes used for safety analysis in source term assessment, or for the study of operating procedures designed to minimize the accident effects. The FP program is part of the general R&D program, related with the approach selected by the safety analysis to prevent and manage severe PWR accidents.

The aims of the FPs Program

A first group of 3 tests (FPT-0, FPT-1 and FPT-2) was used to investigate the effect of burn-up and of the (oxidizing or reducing) environment on fuel degradation, on fission products (FPs) release and transport, and on their behavior in the reactor containment. These 3 tests were achieved with an AG-In-Cd alloy control rod representative of Westinghouse-type PWRs, whose influence on fission products behavior was evidenced.

Another FPT-4 test concerned the ultimate step of the accident, studying the release of little volatile FPs and of transuranians from a debris bed and a molten fuel bath.

The fifth test FPT-3 helped determine the influence of a boron carbide (B₄C) control rod on fuel degradation and FPs behavior. B₄C is a material used in more recent PWRs, but also in boiling water reactors under operation in Europe and in some VVER-type reactors operating in Eastern Europe.

The results of the PHÉBUS PF tests are a significant source of improvement in core melt accident simulation.

Progress of a typical test on PHÉBUS

A test is taking place in two successive steps:

- A core degradation step, of a few hours, during which increasing PHÉBUS core power induces a rise of test fuel temperature up to liquefaction and materials delocalization (between 2,300 °C and 2,500 °C), thereby entailing the release of fission products and their transport in the circuit and the containment. At the end of this step, the PHÉBUS reactor is shut down;
- A “containment” step, of a few hours, during which are measured the quantities of interest to understand transport phenomena, materials depositions, as well as iodine chemistry in the circuit and the containment.

The analysis and interpretation of the results of one test extend over seven years or so.

17. CSD: a French acronym for *Cœur Sévèrement Dégradé*, severely degraded core.

18. PF: a French acronym for *Produits de Fission*, Fission Products (FPs).

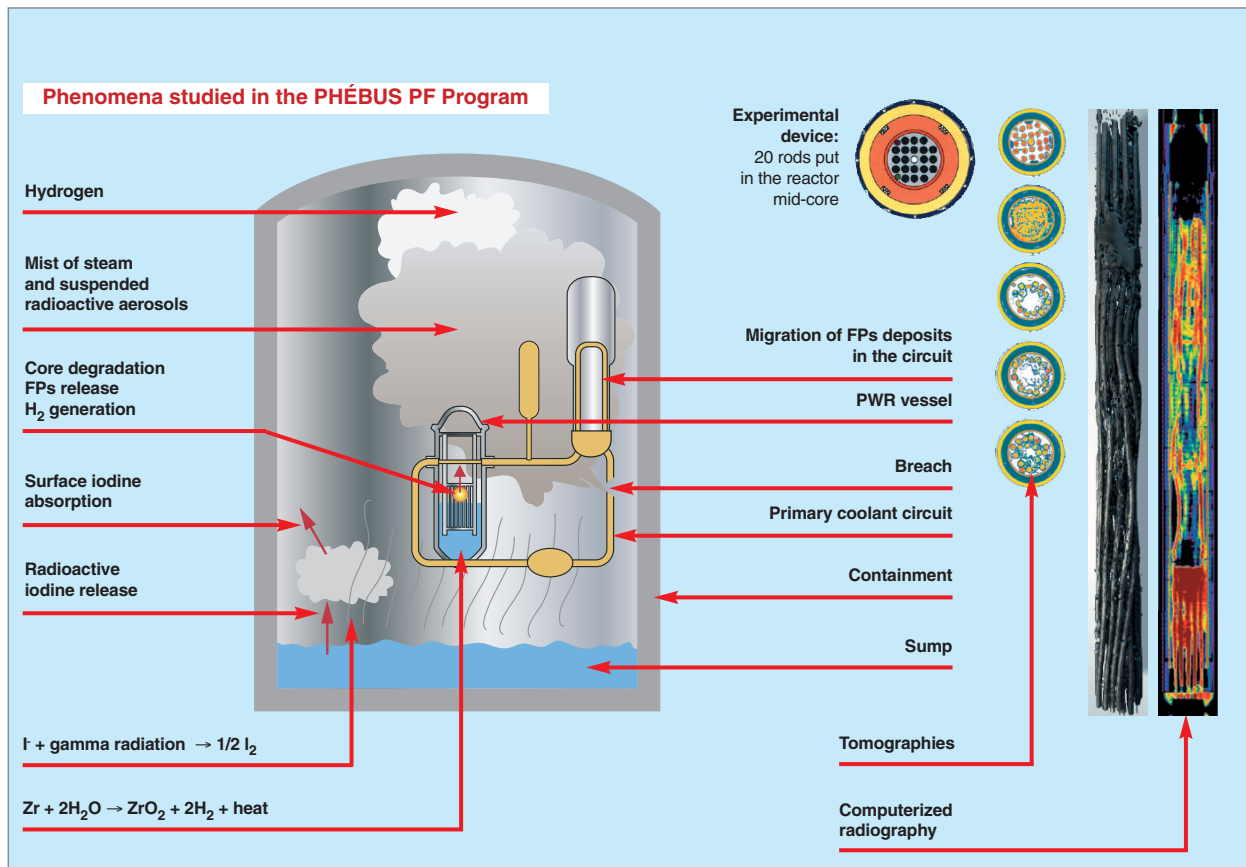

Fig. 4. Principle of a test on PHÉBUS PF, and results on fuel behavior.

The PHÉBUS reactor has conveniently reached its goals. It has led to a better understanding of fuel behavior in loss of coolant accident conditions, and to a justification of the margins taken with respect to this type of accident. It was permanently shut down in 2009.

Jérôme ESTRADÉ,
Reactor Research Department

André CHABRE
Nuclear Energy Division

and Bernard BONIN
Scientific Division

Series of measures illustrating fission products behavior during a PHÉBUS PF test

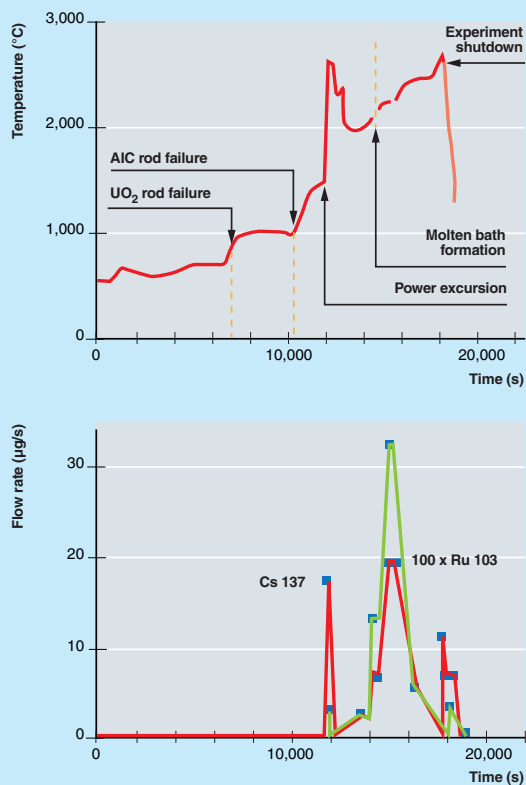

The SILENE Reactor for Studying Criticality Accidents

Criticality accidents

Criticality* accidents result from the triggering of an uncontrolled **nuclear reaction*** which takes place when present amounts of fissile nuclear materials (uranium and plutonium) accidentally exceed a threshold called **critical mass***. As soon as the critical state is exceeded, the chain reaction turns divergent and exponential, hence a fast evolution of the number of fissions generated within the fissile medium, *i.e.* the so-called criticality excursion. This phenomenon is expressed by a fast release of energy (fig. 125), mostly under the form of heat, this release being accompanied with the emission of intense neutron and gamma radiations, as well as by a fission gas release. The exposure to these intense radiations constitutes the main risk in case of criticality accident, and may prove deadly for the staff located in the immediate neighbourhood of the facilities.

This type of accident occurs most often in the facilities where fissile masses are likely to vary, such as fuel cycle plants and research facilities, especially research reactors of the critical mockup type, owing to possible human interventions, which are the main causes of this type of accident.

Since 1945, about sixty criticality accidents have been reported in the world, among them 22 in fuel cycle plants (9 persons died), and about 36 in research facilities (12 persons died). Most of them took place in the United States of America and the former Soviet Union.

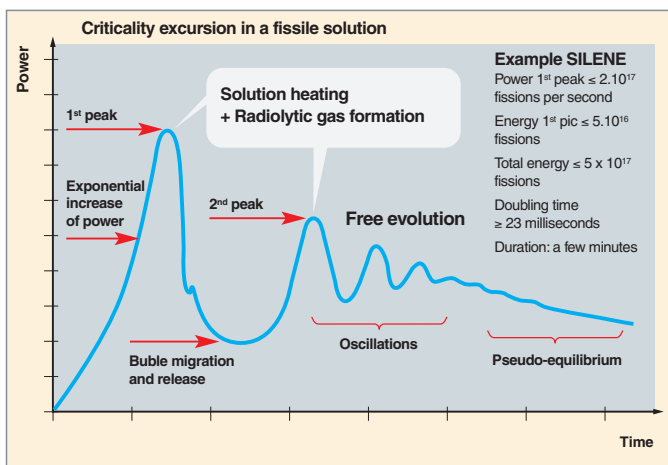

Fig. 125. Power evolution during a criticality accident: typical evolution in a liquid fuel medium.

The experimental study of criticality accidents resulted in the implementation of specific research reactors which allow fast increases of reactivity to be generated by removing neutron absorbers or by putting together fissile materials. In France, the SILENE reactor installed at the CEA Valduc Center is representative of this type of reactor.

The SILENE reactor

The SILENE reactor was commissioned in 1974, initially to meet needs in relation to criticality accident studies in liquid media. In this reactor, fuel consists of highly enriched uranium nitrate contained in a steel vessel, which is diverged through withdrawing a control rod located in its center (fig. 126).

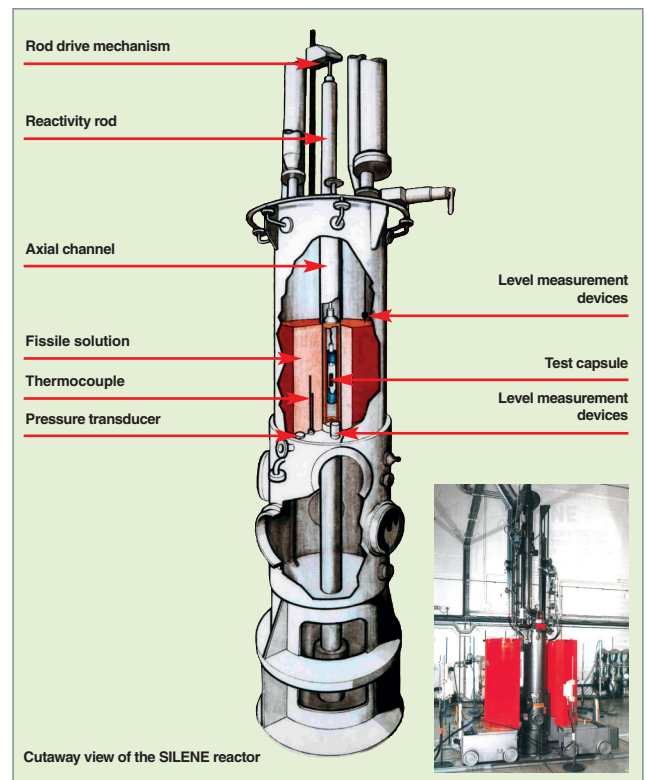

Fig. 126. The SILENE reactor: cutaway view of the reactor block.

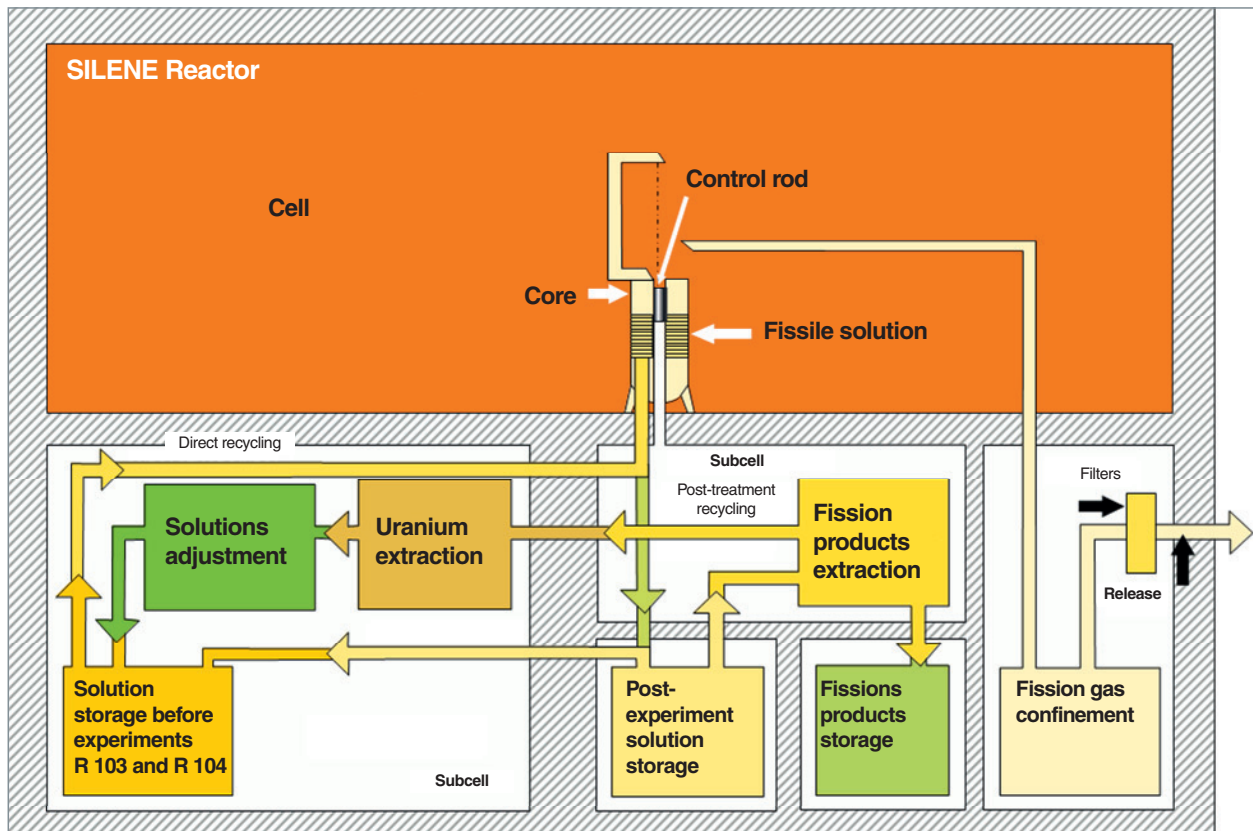

Fig. 127. General features of the SILENE reactor.
 Top cell: the so-called reactor.
 Bottom cell: fuel, radiolytic gas and fission products treatment.

The operation of the reactor requires an infrastructure including means for storage, analysis, fuel concentration adjustment, and recycling of fuel fissile solution, as well as specific equipment for radiolytic gas retrieval. The whole of these means is gathered in premises located under the reactor (fig. 127).

The kinetics of a divergence and the characteristics of leakage radiation are adjustable. Three operating modes are possible (see fig. 128, on the following page):

- In a “burst” mode: the central cavity of the core is accessible, which permits irradiation of samples of a diameter < 56 mm, with a delivered neutron fluence of about $1.6 \cdot 10^{16} \text{ n} \cdot \text{cm}^2 \cdot \text{s}^{-1}$. The neutron and gamma leakage radiations can be altered through placing shields around the core. These are lead, steel and polyethylene-cadmium shields. The first two significantly reduce the gamma component and, in addition, the steel shield allows an increase in the intermediate component of the neutron spectrum. The third one reduces the neutron component;
- In a “free evolution” mode, the excursion rod is slowly withdrawn (at a rate lower than 2 cm/s) in presence of an auxiliary neutron source which allows a deterministic triggering

of the chain reaction. Power increase is slow, and results in a peak very soon damped by temperature and volume feedback mechanisms due to radiolysis (fig. 129). The injected reactivity is limited to 4 β_{eff} to avoid solution boiling to take place. After an oscillatory behavior, reactivity and reactivity feedback at last reach an equilibrium to a power plateau of a few hundred watts or so.

- In a “plateau” mode, obtained through adjustment of control rod position: it leads to power levels between 0.01 W and 10 kW.

The first interest of the SILENE reactor is to allow the criticality accident phenomenology in a liquid medium to be studied in its “burst” and, above all, “free evolution” modes. Thanks to the flexibility brought by SILENE operation, physicists could perform the following actions:

- Characterizing the possible dynamics of the accident as a function of the accidental reactivities likely to be injected;
- Characterizing the radiation field emitted by the accident, developing detection tools (EDAC), and defining a methodology for sheltering persons (evacuation zone) and goods (stopping the accident);
- Characterizing the source term corresponding with the emission of radioelements (aerosols and fission gases).

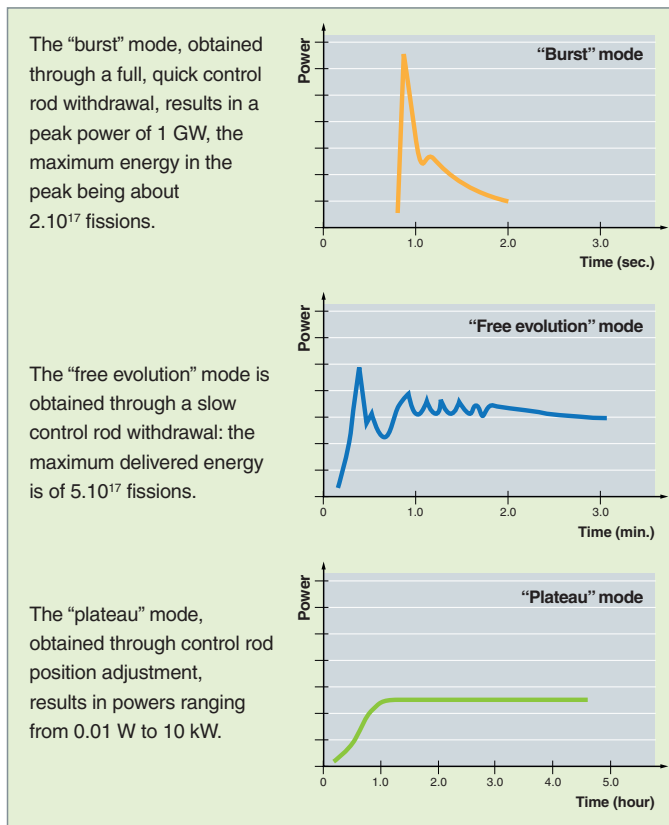

Fig. 128. The SILENE Reactor: an illustration of the three possible operating modes.

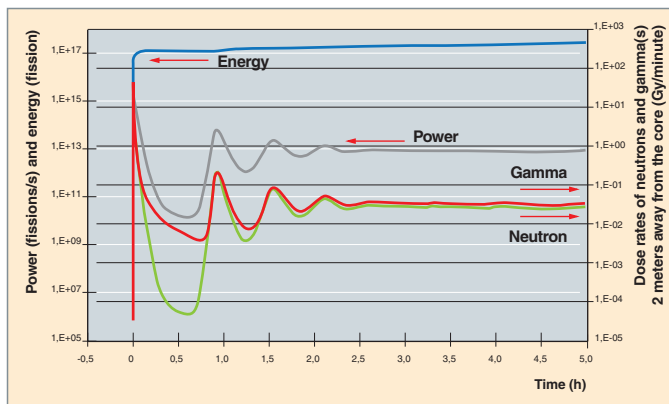

Fig. 129. Dose and dose rate measured during a dosimetry experiment on SILENE in a "free evolution" mode.

Such a tool is unique, indeed. It permitted experimental validation of a certain number of criticality accident computer codes (CHATEAU, CRITEX, POWDER... accident codes). The performed experiments stand as references for validating this type of codes.

The second interest of SILENE and its various shields is to be an intense, continuous or pulsed, gamma and neutron radiation source, whose **fluence*** and fluence ratio n/g can be tailored to demand.

The irradiated materials may be of various natures: biological materials, electronic materials, nuclear or nonnuclear materials. Every year, a radiation protection benchmark is achieved around SILENE, and this benchmark is regularly extended to the international community. For there does not exist any equivalent reactor in the world, likely to be used to carry out such benchmarks that imply dozens of international teams and use the simultaneously irradiation of several hundreds of biological dosimeters or samples. Moreover, intense and transient neutron heatings may be simulated on samples using the central cavity of SILENE. In this cavity were carried out measurements relating to fuel state equation and to the mechanical behavior of PWR rods put in an accident situation (IRSN program named "Reactivity Insertion Accident").

Francis BARBRY
IAEA Expert
André CHABRE
Nuclear Energy Division
and Patrick FOULLAUD
Division of Military Applications

► Bibliography

BARBRY (F.), "A Review of the SILENE Criticality Excursions Experiments", Proceedings of the Topical Meeting on Physics and Methods in Criticality Safety, Nashville, Tennessee, September 19-23, 1993, American Nuclear Society, 1993.

BARBRY (F.) *et al.*, "Review of the CRAC and SILENE Criticality Accident Studies", *Nucl. Sci. Eng.*, 161, pp. 160-187, 2009.

MEDIONI (R.), DELAFIELD (H.J.), AEA Technology and IPSN Report HPS/TR/H/1(95) 1995 : "An International Intercomparison of Criticality Accident Dosimetry Systems at the SILENE Reactor, Valduc", Dijon, France, 7-18 June 1993.

VERREY (B.) *et al.*, "SILENE Reactor: Irradiation Tool for International Exercise of Criticality Accident Dosimetry Systems", 9th Symposium on Neutron Dosimetry 28/9-03/10, Delft, Netherlands, 2003.

Outlooks for Research on Accident Situations with the Jules Horowitz Reactor

The Jules Horowitz Reactor (JHR) provides an extended range of experimental alternatives in terms of neutron flux, and locations available in the core or the reflector. Consequently, and though experimental programs relating to accidental situations are most often achieved in a dedicated reactor, this flexibility is likely to be used in the JHR to treat such situations, especially loss of cooling accidents and overpower accidents. For this purpose, the facility will make use of the technological developments implemented for the construction of experimental devices. As regards fine power control in the experimental load, it can be achieved putting the irradiation device on a displacement system which is located in water channels arranged in the reflector. The irradiation device can be positioned farther from or closer to the core through the displacement system, which allows for a precise, flexible adjustment of power without significantly interfering with the reactor itself. The device may also be placed at a fixed position, but in this case, power control is ensured by the core itself, which may impede the other experiments conducted in parallel.

Loss of cooling situations

In order to simulate loss of cooling situations, the experimental protocol consists in simulating a temperature rise generally obtained by controlling the power injected into the device. This temperature rise allows a loss of cooling at rated power to be simulated representatively. The device is designed with a thermal insulation adjusted so as to ensure the safety of the experiment. The temperature rise kinetics are generally rather slow (from a few tenths of degree to a few degrees per second), which remains compatible with the study of loss of coolant transients.

The irradiation device design strongly depends on the objectives, according to whether the study is focused on fuel and clad behavior at various temperature and power levels (likely to evolve to melting), or on radioactive products release (also depending on the temperature and/or the atmosphere prevailing around the fuel). From these conditions are drawn the device design (structures, nature and thickness of the insulator put between fuel and the outer walls), the appropriate number of rods and their geometry, and power homogeneity required in the various test rods.

Given the technologies already implemented for this type of experimentation, the facility provides in-core capacities which are expected to be compatible with assemblies going up to 7 rods in the core. In the reflector, assemblies of about 15 to 20 rods can be considered. Larger test volumes would require more detailed siting studies which could go up to reflector upgrade. Relatively homogeneous power distributions can be obtained through neutron adjustments, making use of the part of the fast neutron flux which exists near the reactor vessel.

Concerning the circuit, the latter may be a mere tool for controlling thermohydraulic conditions (steam flow rate, pressure), or getting a more complex experimental function, for instance by transferring released fission products towards measuring devices located in the “experimental cubicles”. Authorized ground loads (6 t/m^2) allow a shield (biological shielding) to be emplaced around the measuring lines and instruments, as well around fluid collecting tanks. The connection between the irradiation device and the circuits will have a major impact on the facility. For the experiment may be compatible or not with the implementation of the irradiation device on a displacement system. In this case, the experiment will take place simultaneously with other experiments. Reversely, in the case of an in-core experimentation, the facility operation will have to be temporarily dedicated to the experimentation.

An example which may be mentioned is the “LORELEI” device under design. It will be used for safety studies relating to “loss of coolant accidents” in light water reactors.

The fields investigated are related with the “thermo-mechanical” features of the fuel rod and the radiological consequences (source term assessment) in accidental situations of this type.

This device will be emplaced in the JHR reflector, on a displacement system (to adjust the power level in the device) (see fig. 130, on the following page).

It will consist of an outer tube of about 80 to 90 mm diameter, in which the experimental rod will be emplaced, displaying a length adapted to the phenomena investigated (40-100 cm). Thermal insulators placed between the rod and the outer tube will allow the sample to be brought to temperature levels representative of this type of accident, *i.e.* about

1,200 °C. The internal structures will bear an instrumentation adapted to this type of experiment (temperature, pressure, deformation measure...). The device will be connected to an “out-of-pile” circuit, whose functions will be to control the system pressure, to inject water or gas, and, last but not least, to collect the fluids coming from the device.

Overpower situations

In the field of experimentations relating to power transients, it is clear that displacement systems provide an interesting experimental capacity for experiments called “power ramps”: for example, the neutron characteristics of the core and the performances of the displacement system allow ramps at 600 W.cm⁻¹.min⁻¹ for ²³⁵U 1 % enriched fuel (corresponding with high burnups)

In contrast, the JHR is not designed to cover the area of reactivity-initiated accidents (RIA), with power peaks extending over a few dozen milliseconds. The CABRI reactor is better adapted to this type of simulation. Yet, the high neutron flux occurring in the core can be used to carry out an analytical study of some mechanisms associated with fast thermal transients, still without reaching conditions representative of the RIA.

For this purpose, it could be designed a device containing capsules loaded with fuel samples, which would go across the flux area according to a short and precise kinetics. Heating kinetics of a few hundred degrees per second in the fuel could be reached with the help of this technique.

As a conclusion, beyond its main mission, the JHR will make it possible to carry out more thorough studies on LOCAs on the basis of those undertaken in PHÉBUS, and will complete the studies conducted in CABRI in relation to fast transients.

Christian GONNIER
Reactor Research Department

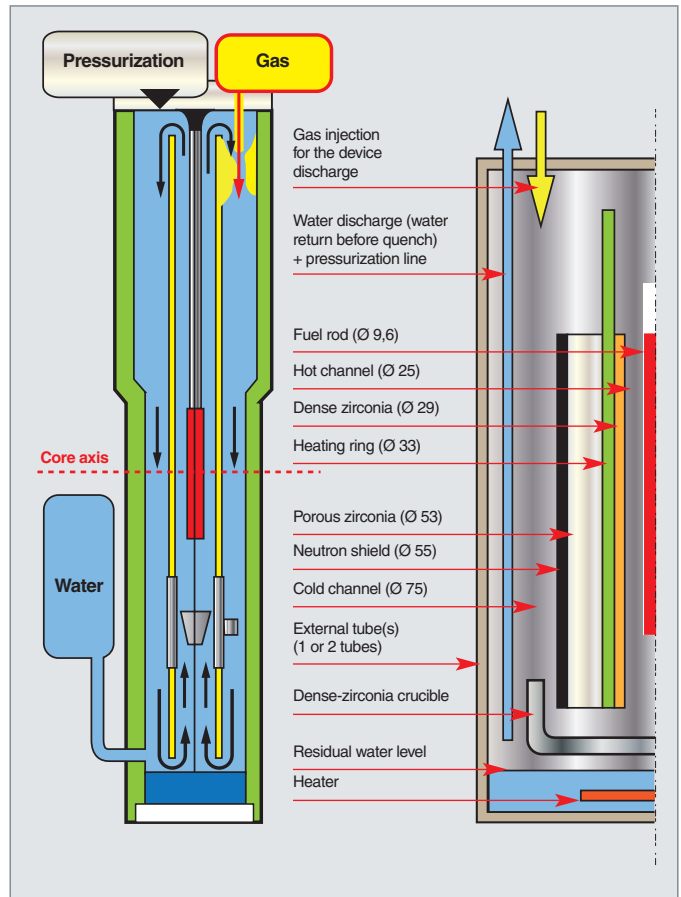

Fig.130. Schematic of the LORELEI experimental device designed to investigate LOCA accidents. A fuel rod section is put in the JHR reflector in conditions representative of a water reactor fuel, and is then subjected to a loss of coolant accident scenario. The rod results uncovered, which induces its degradation. The LORELEI device is used to analyze the behavior of the rod and of FPs released during this accident sequence.

Worldwide Overview of Research Reactors

Research Reactors in the World

The status of the research reactor fleet

Since the early fifties, over 670 research reactors of all types have been built in the world and registered. Today, 234 among them are under operation in 58 countries, while the others are definitely shutdown, dismantled, or pending dismantling.

Tables 13 and 14 hereafter show the distribution of reactors under operation per continent, as well as countries endowed with the major fleets of operating research reactors.

Table 13

Distribution of operating research reactors per continent	
Continent	Number of operating research reactors
Europe (including Russian Federation)	100
North and South America	66
Asia/Pacific	59
Africa	9

Table 14

Countries endowed with the major fleets of operating research reactors	
Country	Number of operating research reactors
Russian Federation	48
USA	41
China	15
Japan	13
France	11
Germany	10

Those constructions took place in successive waves. The first wave, from the fifties to the seventies, characterized the industrialized countries of the Western world and the countries of the communist block, which placed high hopes in the outlooks displayed by the civil applications of nuclear energy; most of it was induced by the United States and the Soviet Union, which benefited from the experience gained with nuclear energy developments for military applications.

In this first period displaying a very high boost, research reactors of any type were built; for, then, there were needs of development and qualification in every field: nuclear physics, neutronics, nuclear power reactor systems, and fuels. From the seventies, the rate of construction of research reactors strongly declined, for major choices relating to power reactor systems had already been made, and the research reactor abilities in technological irradiations, training, etc. had reached a sufficient level to meet demand.

The second wave, less strong, took place from the seventies to the nineties, and most particularly concerned the major developing countries in the period in Asia and in the Pacific, especially Japan, China, South Korea, and India, which in turn were starting to develop nuclear energy.

Figure 131 (on the following page) displays the evolution over time of the research reactor number, with the quick rise in the 1950-1970s up to a peak of 367 operating reactors towards 1975, the relatively fast decline in the following decades, partly compensated by the commissioning of experimental reactors in developing countries and the commissioning of specialized reactors (for matter studies, tests in accidental situations...), and then the present stabilization. It is worth to mention that only about 30 % of research reactors exhibit a power exceeding 1 MWth, and that only about ten percent of them have a power over 25 MWth.

As was already mentioned, research reactors are tools which often carry out several types of activities. Among the 234 reactors under operation:

- Over 50 percent of them are materials test and multipurpose reactors (*i.e.* also producing radioisotopes, providing neutron beams for research...);
- About 20 percent of them are critical mockups of very low power;
- About 13 percent of them are small reactors mostly dedicated to teaching and training.

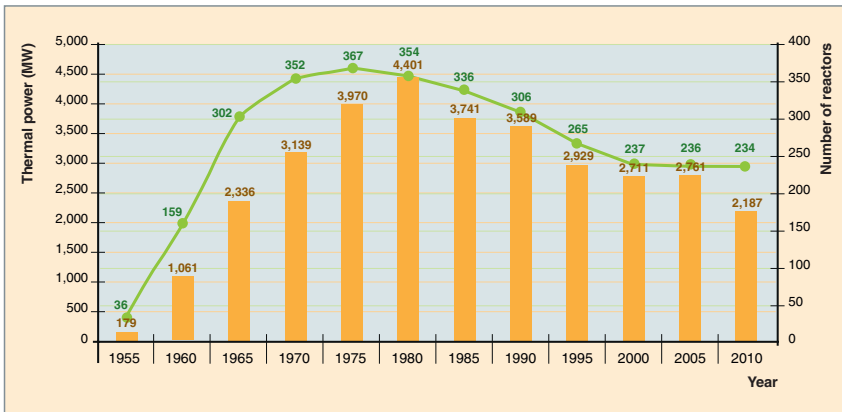

Fig. 131: Evolution of the number of operating research reactors registered in the world.

The following figures 132 and 133 show the current situation for the main materials test reactor which strongly contribute to the development and use of nuclear power reactors [1].

Figure 134 (p. 138) displays the status of the main reactors used as neutron sources for fundamental research.

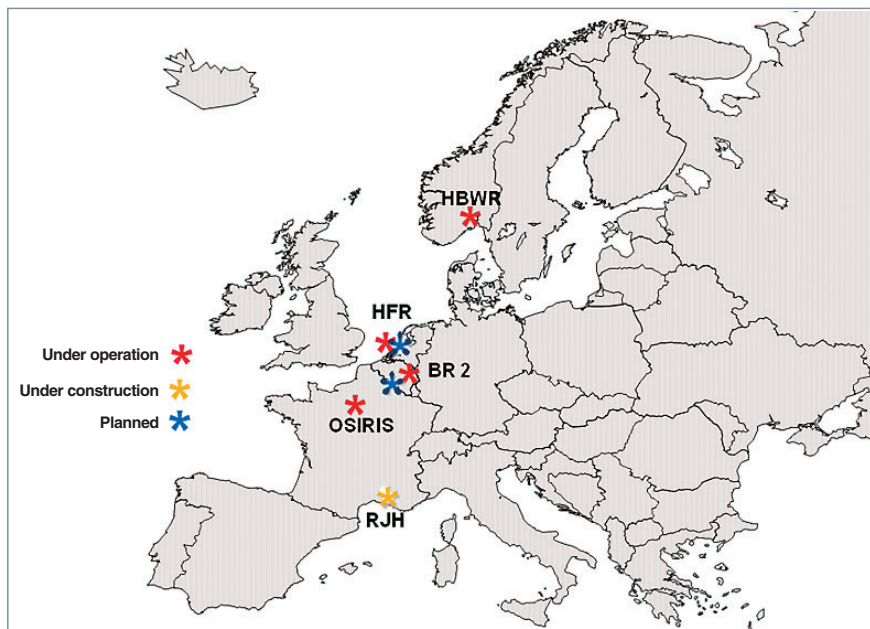

Table 15

Main materials test reactors in Western Europe

Country	Situation	Reactor	Divergence	Power
France (Saclay)	Under operation	OSIRIS	1966	70 MW
France (Cadarache)	Under construction	JHR ¹	2016	100 MW
Belgium (Mol)	Under operation	BR2	1961	100 MW
Belgium (Mol)	Planned	MYRRHA ²	2022/2023	50/80 MW
Netherlands (Petten)	Under operation	HFR	1961	45 MW
Netherlands (Petten)	Planned	PALLAS ³	2017/2018	30-80 MW
Norway (Halden)	Under operation	HBWR	1959	25 MW

1. Note: Scheduled to succeed OSIRIS.
 2. Note: Scheduled to succeed BR2.
 3. Note: Scheduled to succeed HFR.

Fig. 132: Main materials test reactors in Europe (In bold type: reactors under operation).

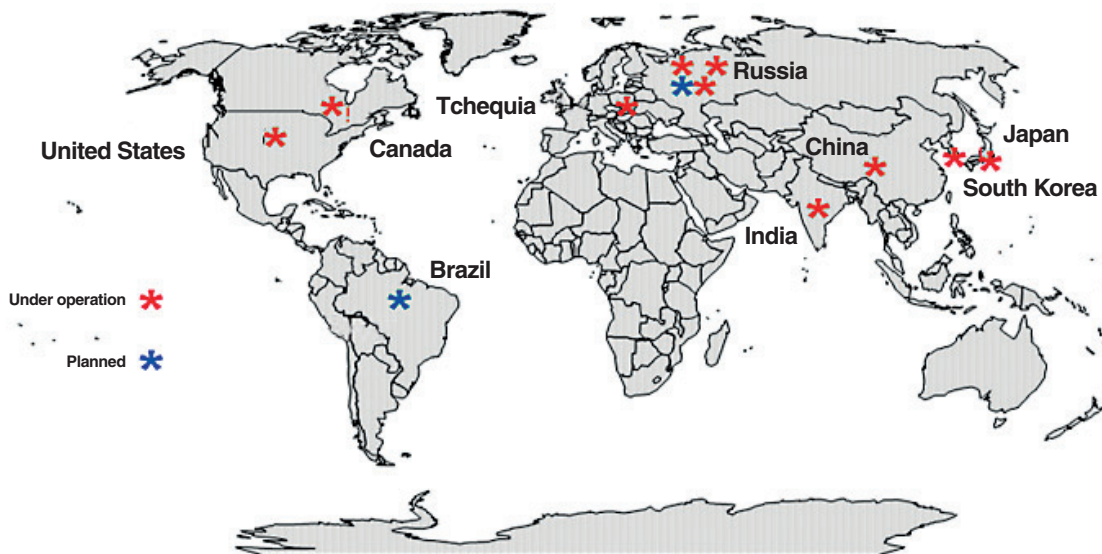

Table 16

Main materials test reactors in the world outside Western Europe				
Country	Situation	Reactor	Divergence	Power
EASTERN EUROPE				
Russia (Dimitrovgrad)	Under operation	SM-3	1961	100 MW
Russia (Dimitrovgrad)	Under operation	MIR	1966	100 MW
Russia (Dimitrovgrad)	Under operation	BOR-60	1969	60 MW
Russia (Dimitrovgrad)	Planned	MBIR ¹	2019	150 MW
Tchequia (Rez)	Under operation	LVR-15	1957	10 MW
NORTH AND SOUTH AMERICA				
United States (Idaho)	Under operation	ATR	1967	250 MW
Canada (Chalk-River)	Under operation	NRU	1957	135 MW
Brazil (Ipero)	Planned	RMB	Undetermined	30 MW
ASIA - OCEANIA				
China (Omei)	Under operation	HFETR	1979	125 MW
Japan (Oarai)	Under operation	JMTR	1968	50 MW
South Korea (Daejong)	Under operation	HANARO	1995	30 MW
India (Bombay)	Under operation	DHRUVA	1985	100 MW

1. Scheduled to succeed BOR-60.

Fig. 133. Main materials test reactors outside Western Europe. (In bold type: reactors under operation).

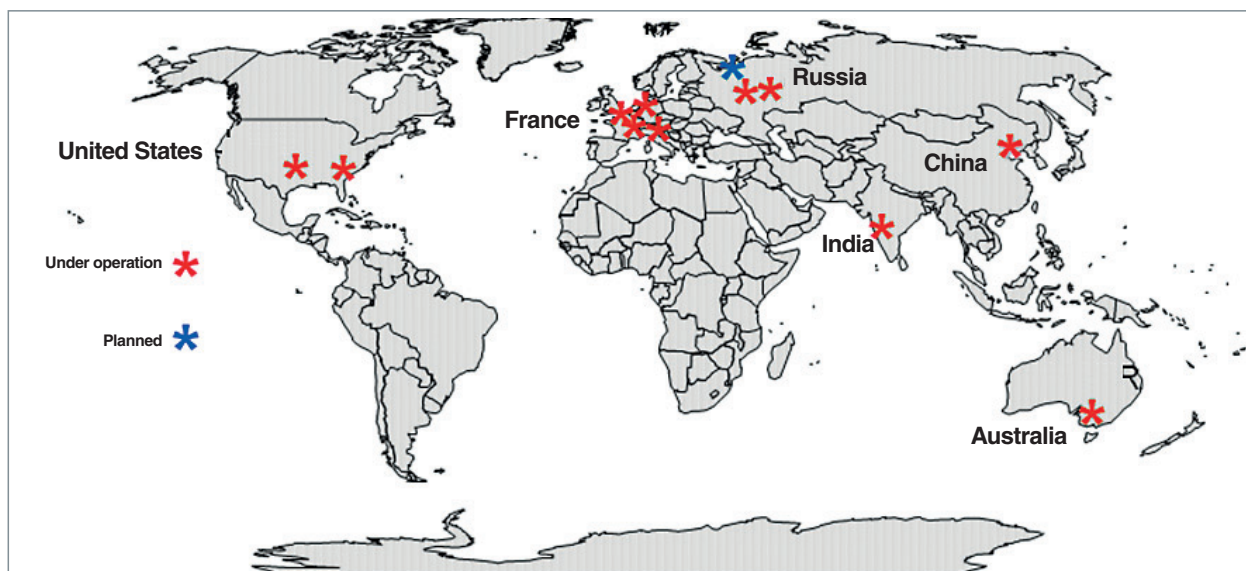

Table 17

Main research reactors used as intense neutron sources for research				
Country	Situation	Reactor	Divergence	Power
EUROPE				
France (Saclay)	Under operation	ORPHÉE	1980	14MW
France (Grenoble)	Under operation	RHF	1971	57 MW
Germany (Garching)	Under operation	FRM-II	2001	20 MW
Germany (Berlin)	Under operation	BER-II	1973	10 MW
Russia (Moscou)	Under operation	IRT	1967	2,5 MW
Russia (Sverdlovsk)	Under operation	IVV-2M	1966	15 MW
Russia (Saint-Petersburg)	Under commissioning	PIK	2011	100 MW
NORTH AND SOUTH AMERICA				
United States (Gaithersburg)	Under operation	NBSR	1967	20 MW
United States (Oak-Ridge)	Under operation	HFIR	1965	85 MW
ASIA - OCEANIA				
China (Beijing)	Under operation	CARR	2010	60 MW
India (Bombay)	Under operation	DHRUVA	1985	100 MW
Australia (Lucas-Heights)	Under operation	OPAL	2006	20 MW

Fig. 134. Main research reactors used as intense neutron sources for fundamental research. (In bold type: reactors under operation).

Features of the research reactor fleet and related problems

Fleet ageing and under-use

A number of research reactors are getting old today: 70 % of operating research reactors in the world are over 30, and 50 % are over 40 [2].

This ageing particularly concerns the research reactors of the “first wave” built in America and Europe and, especially, the materials test reactors shown on Figures 132 and 133, all of them totalizing between forty and fifty years of operation today.

For these reactors, the question of whether they go on operating or are shut down, with or without the construction of a substitutional reactor, is pending, as a function of the following factors:

- Use of nuclear energy and related outlooks in the country considered, and resulting needs;
- Impact of their upgrading, given the safety and regulatory requirements to be implemented;
- Their environment, which often evolves along decades;
- Available financing;
- The existence or not of reactors of similar capacities in the region, in the continent considered, and, more generally, in the world.

In addition to this status, an increasing under-use, especially of small-power research reactors, has been evidenced by the audits conducted by the IAEA, which, for 50 % of operating research reactors, assesses their yearly activity as being lower than 4 conventional operating weeks (7 days of 24 hours) at rated power.

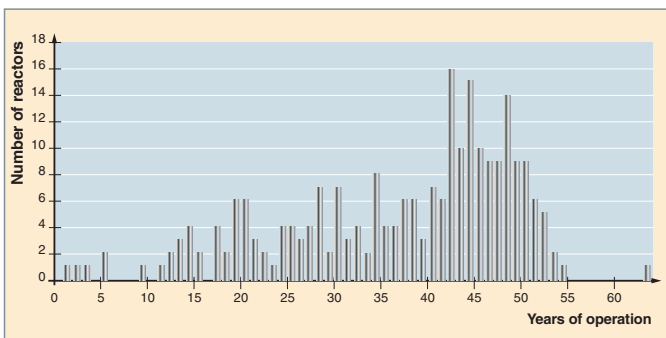

Fig 135. Age distribution of operating research reactors in the world.

Consequently, in the projections carried out by the IAEA, 100 to 150 research reactors would be operating by the year 2020, against 234 currently operating.

Nonproliferation policy and its consequences on research reactor fuel

The fifties and sixties have been an exceptional period of expansion for research reactors. In the Western world, this trend has been integrated into the policy “Atoms for Peace” initiated by the United States. A parallel approach has developed in the whole of the “Communist block” countries under the impulse of the USSR. On either side, in order to operate these reactors, the United States and Russia supplied significant amounts of enriched uranium and, especially, of Highly Enriched Uranium (HEU), likely to reach a 93 % ^{235}U enrichment. The latter can help provide high neutron fluxes in the best conditions, an essential feature of research reactors. As the number of experimental reactors was quickly increasing, it soon became obvious that using this HEU, even as part of scientific and technological developments, induced inevitable risks of **proliferation***, due to deliberate misuses or theft of this HEU.

So, in 1978, the United States launched the RERTR (Reduced Enrichment for Research and Test Reactors) Program in order to reduce the HEU use in research reactors, developing fuels likely to “convert” these reactors to the use of the so-called “low-enriched” uranium (LEU), deemed to be “nonproliferating”. The ^{235}U enrichment percentage of “nonproliferating” LEU was then fixed by the United States at a maximum of 20 %, taking into account both the so-called risk of diversion or theft of non-irradiated HEU, and the risk arising from plutonium generation during fuel irradiation [3].

This initiative, initially oriented to reactors supplied with enriched uranium by the United States, was extended in the early eighties, in collaboration with Russia, to countries supplied with enriched uranium by the latter.

At last, in 2004, this initiative was strengthened and integrated into a broader initiative, the GTRI (Global Threat Reduction Initiative) under the aegis of the United States, the Russian Federation, and the IAEA [4]. The GTRI gathers 130 countries and concerns:

- The conversion to LEU of research reactor fuels using HEU, and of uranium targets used in these reactors to produce the radioisotope Mo-99 for medical purposes (see above the chapter on “What are Research Reactors Used for?”, *supra*, pp. 11-30, and the inset on “Artificial radionuclide production”, *supra*, pp. 24-26);
- The elimination or removal to safe sites of nuclear and radiological materials likely to be used to make nuclear weapons;

- The protection of the sites containing nuclear and radiological materials likely to be used to make nuclear weapons.

Today, after 30 years of efforts, the GTRI conclusion regarding the “conversion” of research reactors using HEU is as follows:

- 67 among them were converted or shut down;
- 35 among them are under conversion or awaiting conversion, the latter being possible with present standard fuels usually implemented in research reactors;
- 27 top-performing reactors are awaiting the development and qualification (under way) of a fuel using LEU, but with high-density uranium, to be converted in satisfactory cost and performance conditions (see the inset on fuels developments for research reactors in the chapter on “The Jules Horowitz Reactor”, pp. 95-96).

The objective announced by the GTRI is to reach the finalization of these conversion activities around 2020.

- Last but not least, 78 reactors are deemed to be “nonconvertible” owing to their national defense activities or their special designs.

This trend of “conversion to LEU” has a strong impact on research reactors and, especially, many small-power reactors for which owner institutes and organizations do not always have the technical and financial means to ensure the conversion despite the support of major powers, mainly the United States and the Russian Federation, and of the IAEA.

It also concerns highly performing research reactors awaiting the qualification and industrialization, launched in 1995, of high-density LEU fuel, which calls for development efforts and investments far from being negligible, and whose success will depend from both its ability to reach the expected performances and its implementation cost, expected to be comparable to that of present fuels.

The back-end of research reactor spent fuels

Most of research reactor fuels consist of uranium powder type UAl or U_3Si_2 , the second type not allowing for spent fuel treatment after irradiation in today’s industrial conditions.

Operators of research reactors can, however, send back their spent fuels to the United States and the Russian Federation when these countries have supplied them with the corresponding enriched uranium. This alternative is very important for the operators of research reactors located in countries which do not have industrial nuclear facilities. For instance, it avoids them to assume the management of long-lived “ultimate waste” contained in spent fuels. So they intensively use this alternative, as spent fuel management costs are matched with their financial capacities.

As regards reactors located in countries which have industrial nuclear facilities, their operators also make use of this alternative, or adapt specific provisions such as spent fuel treatment when the latter is possible, as is the case in France, or long-term storage.

In the future, spent fuel outcome will very much depend on the following items:

- Regarding the research reactors located in countries which do not have industrial nuclear facilities, on whether the United States and the Russian Federation maintain or not their spent fuel return policy, or on alternative provisions considered within an international framework, particularly a joint storage/disposal in a willing country;
- On the results of the development and implementation of the new UMo-type fuel under qualification, which can be treated. Yet, for small reactors and reactors located in countries with low financial capacities, assuming spent fuel treatment cost may be a crucial condition.

What about the future of research reactors?

Energetic needs and outlooks of the world’s nuclear power fleet

After a halt due to the Tchernobyl accident, nuclear power has started again in the world due to the planet’s increasing needs in energy, and to hydrocarbon depletion. Other factors are favorable to nuclear power: the latter produces an economically competitive kWh, without generating greenhouse effect gases. The Fukushima accident may perhaps harness the development of nuclear energy in the Western World and in Japan, but it is not expected to have a determining impact on the development of nuclear energy in the rest of the world, especially in emerging countries, *i.e.* China, India, Brazil. It is

also worth to mention, without pretending to provide an exhaustive list, the numerous other countries which have declared their intention to make use of nuclear energy: in the Middle East, the United Arab Emirates (two reactors ordered), Saudi Arabia, Jordania, Egypt, Turquia; in Asia, Vietnam, Thailand, Indonesia; in Africa, Morocco, Tunisia; in Europe, Poland, and the Baltic Countries.

In order to meet these needs, the evolution of nuclear power reactors takes place according to the two successive approaches:

- An approach which privileges continuity, and consists in pursuing the valorization of known and proven technologies of the latest reactors commissioned, significantly improving their safety level, first, and their economic competitiveness, and integrating them in a sustainable development approach (particularly, minimizing generated waste). These evolutionary reactors, the so-called “Generation III” reactors (see on Fig. 136 the four generations defined for nuclear power reactors) are designed to meet the demand for the next 30 to 40 years. In France, the leader of this generation is the EPR (European Pressurized water Reactor);
- On a longer term, a technological disruption is under preparation with fast neutron reactors, which are to help:
 - Strengthening the sustainable character of nuclear energy using all the potential energy contained in uranium, *i.e.* fission energy not only of the U 235 isotope, as is the case in most of current reactors, but also of the much more abundant U-238 isotope, which multiplies by a 50 to 100 factor the energy production capacities for a given uranium mass!
 - Strongly reducing ultimate waste generated in volume, lifetime and toxicity;
 - Extending the scope of nuclear energy in order to adapt it at best to needs (heat, hydrogen... generation).
- On the other hand, a trend is emerging towards the implementation of small-power reactors (from 300 MWe to a few dozen MWe) and medium-power reactors (from 600 to 300 MWe) in order to meet local and diversified energetic needs. Projects are very numerous: they often refer to innovative concepts with the aim of displaying simultaneously the utmost safety, a relatively simple operation, and competitiveness in their context of use.

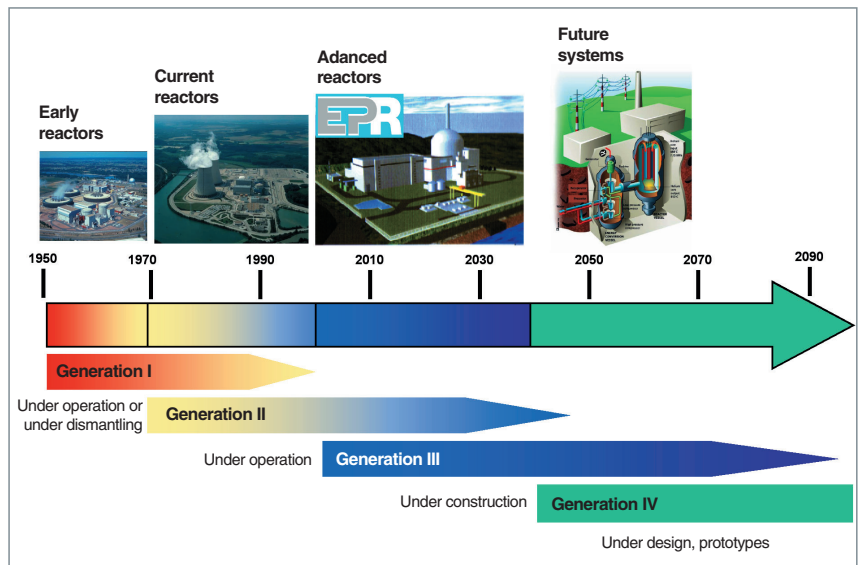

Fig. 136. The four generations of nuclear power reactors.

Evolution prospects for research reactors

The overview of outlooks for nuclear power put forth in the previous paragraph shows that the need for research reactors of all types does exist, indeed, for the following purposes:

- To go on improving the operation, safety and performance of operating nuclear power reactors, the number of which is increasing;
- To take part in the important developments associated with the nuclear systems of the future under consideration, especially with materials test reactors and safety test reactors;
- To accompany the numerous countries considering access to nuclear power for the first time (“newcomers”), especially with training and radioisotope production reactors.

Given these needs, the situation of research reactors can be summarized as follows:

- Research reactors are expected to have long lifetimes up to 50 years and beyond, due to the simplicity and low power characterizing many of them. However, the world fleet of these reactors is strongly ageing for the most part, and the construction of new units at the current rate (8 reactors under construction today) will not compensate shutdowns for a long time.

- Many small research reactors are under-used whereas, *a contrario*, several nuclear power “newcomers” combine their prospects of using nuclear power reactors with that of buying research reactors. Such is the case, in particular, of Jordania, which has recently ordered an experimental reactor, and of Tunisia, Singapour, Azerbaïdjan... Hence the idea to focus the efforts around a few research reactors shared on a regional scale. For this purpose, the IAEA gathers the countries which have research reactors, as well as those interested in the latter’s activities. Four groups are under operation, and several others are in preparation, especially for the areas “Mediterranean countries” and “Asia-Pacific”;
- As regards high-power research reactors designed to perform technological irradiations and safety tests;
 - There exists quite a number of authorities likely to foster concertation: the IAEA, OECD’s Nuclear Energy Agency, initiatives such as the Generation IV International Forum (GIF), which care for the availability of the research reactors needed to develop these projects, within the framework of a shared use;
 - Europe has integrated experimental facilities in its strategic plan relating to technologies for energy [Strategic Energy Technology Plan of the European Union, the so-called “SET Plan”]. Several initiatives, described below, have been taken to induce a coherent policy in this field.

The emergence of a European policy relating to research reactors

In 2001, the European Commission for Atomic Energy expressed concerns about European abilities in materials test reactors, the latter being an indispensable and determinant support in the development of fuels and materials for nuclear power reactors, and launched the Future European Union Needs in Material Research Reactors (FEUNMARR) Program, gathering the most representative European research institutes with a view to examining needs for the 2020 (Generation III reactors) and 2040 (Generation IV reactors) deadlines. In 2003, this program concluded that it was necessary to have at least one new materials test reactor in Europe in the 2010-2020 decade, likely to succeed reactors currently operating as a European platform playing a prominent international role. This is the Jules Horowitz Reactor, whose construction was launched by the CEA at Cadarache, which is to meet most of this need by the year 2016 (for the description of the JHR and of its experimental programs, see above the chapters on “The Jules Horowitz Reactor”, pp. 95-100, and “Outlooks for Research on Accident Situations with the Jules Horowitz Reactor”, pp. 131 and 132).

In order to meet a more general organization need, in the context of a global shared view, the European Commission has set up an energy-related strategic development plan, approved by the Member States and including nuclear energy, within the framework of the European Research Area (ERA): the European Strategic Energy Technology Plan (SET-Plan) and, in 2007, a forecast and coordination organization for nuclear energy studies and developments of nuclear energy, the SNETP (Sustainable Nuclear Energy Technology Platform), intended to examine, at a European level, needs in developments for fission reactors, define the corresponding research axes, organize their deployment, and determine and promote the achievement of infrastructures and test facilities required to conduct these research programs. The developments and achievements arising from this organization’s works are conducted through initiatives launched in co-operation with concerned companies.

Thus, the today SNETP includes nearly 80 organizations issued from 20 countries which practically gather all European power utilities, all nuclear engineering branches, all European nuclear research organizations, and numerous European Universities and learned societies.

Figure 137 (on the following page) displays the objectives considered by the SNETP for major facilities to be implemented in Europe in the field of research reactors and, more particularly, in relation to materials test reactors and reactors “demonstrating” nuclear reactor system concepts, that is:

- The Jules Horowitz Reactor, a CEA materials test reactor in France put forth in detail in the chapter titled “Jules Horowitz Reactor” (see above, pp. 95-100), which is a 100 MWth pool-type reactor under construction at Cadarache within the framework of an international consortium. The JHR start of operation is scheduled by the year 2016 (fig. 138, on the following page). By this date, the reactor and related facilities will constitute a technological irradiation platform of reference likely to meet operational and development needs of Generation II, III and IV nuclear power reactors;
- The MYRRHA reactor project of SCK/SEN in Belgium: this is a 100 MWth reactor of the **ADS*** (Accelerator Driven System) type, *i.e.* consisting of a particle accelerator and a “target” (made of lead-bismuth in this case), which generates an intense fast neutron beam by spallation (see fig. 139 on the following page). The aim of this reactor is twofold: being the demonstrator of the operation of an ADS system at a representative power, as well as of the concept of Generation IV reactor of the lead-bismuth fast neutron spectrum reactor type, a technological alternative to sodium-cooled fast neutron spectrum reactors; and being a high-performance materials test reactor, especially for materials irradiations, thanks to its high fast neutron flux.

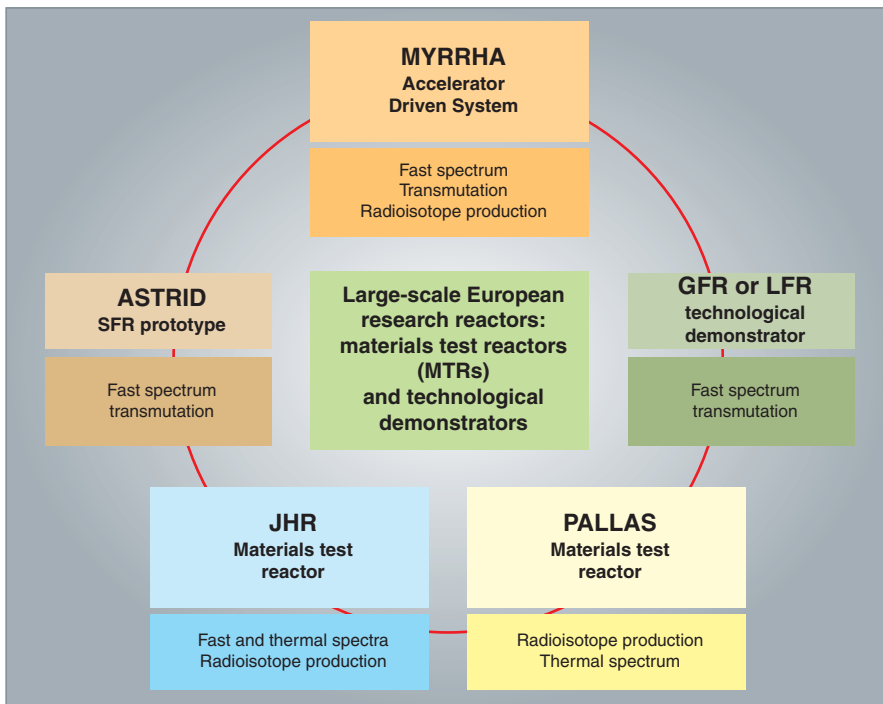

Fig. 137. European outlooks considered by the SNETP for research reactors categorized as materials test reactors, technological demonstrators and prototypes.

- The MYRRHA reactor is under design: similarly to the JHR, its achievement is to take place as part of a broad international co-operation. The present planning schedules a construction stage in 2016/2018 on the SCK/SEN site of Mol, with a view to a commissioning around the years 2023/2024.
- The PALLAS reactor of NRG in the Netherlands, a 30-80 MW_{th} pool-type research reactor designed for the intense production of radioelements for medical applications and, especially, of Mo-99, an essential radioelement today for achieving a very high number of medical examinations. PALLAS will also perform technological irradiations in addition to those of the JHR and MYRRHA; it is to induce a call for bids with a view to an achievement on the Petten site (Netherlands), and a commissioning by the years 2016/2018.

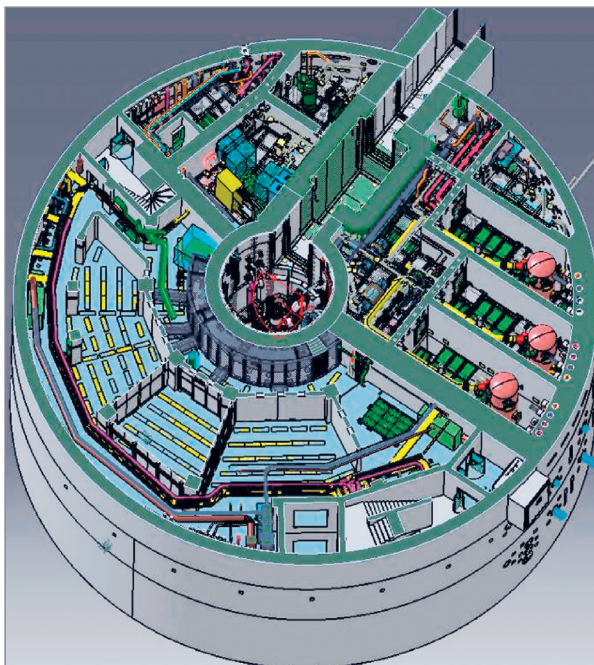

Fig. 138. Cutaway view of the Jules Horowitz Reactor and the associated experimental devices.

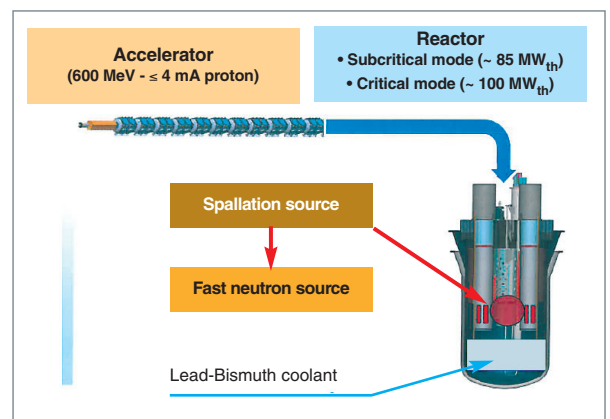

Fig. 139. MYRRHA reactor: a materials test reactor and technological demonstrator of the concept of fast-spectrum, lead-bismuth Generation IV reactors. The reactor is designed for ADS operation (it is then in a **subcritical*** mode), or for operation in a critical reactor mode with no accelerator, when the aim is getting the highest neutron fluxes to carry out irradiation programs.

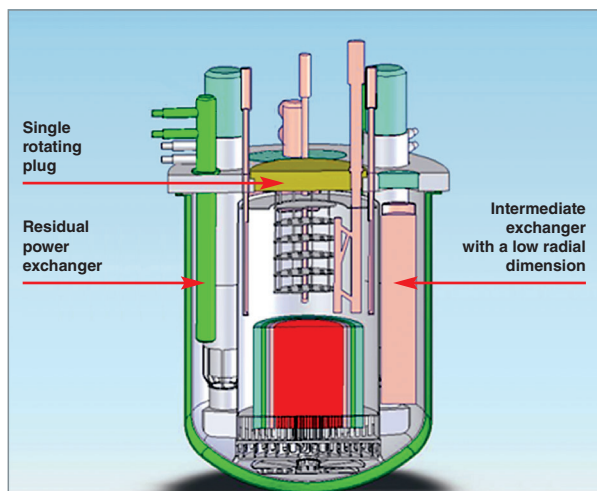

Fig. 140. Cutaway view of the sodium-cooled fast neutron reactor ASTRID.

- The CEA's ASTRID reactor project in France, a prototype of the reactor concept of the Generation IV sodium-cooled fast neutron reactor system (fig. 140). This reactor, with a 250-600 MWe scheduled power, is in a preliminary design stage prior to the decision to go on, to be taken in 2012. It is to be built at CEA/Marcoule site in France, within the framework of a partnership with industries, with a commissioning by the

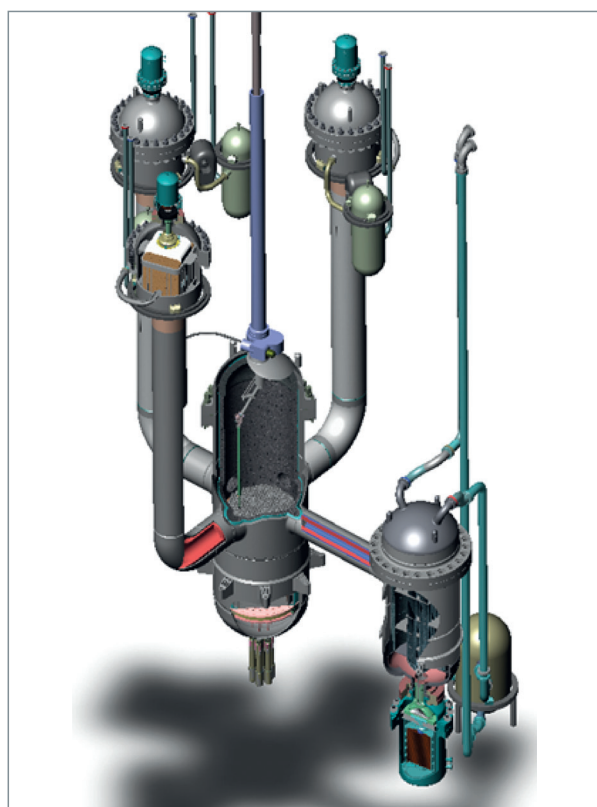

Fig. 141. ALLEGRO, the gas-cooled fast reactor prototype.

years 2020/2025. The ASTRID reactor project would also include the achievement of the fuel fabrication and treatment plant so as to provide a full demonstration of the concept.

- The project of reactor demonstrating the concept of gas- or lead-bismuth-cooled Generation IV fast neutron reactor, depending on the status of these two techniques, as an alternative to the sodium-cooled Generation IV reactor. A first design of the "gas-cooled" version of this reactor named ALLEGRO has been undertaken at the CEA (fig. 141). If this reactor is selected, it will be built within a European framework.

André CHABRE
Nuclear Energy Division

► References

- [1] A. ALBERMAN, "Panorama des réacteurs expérimentaux dans le monde" CEA, RGN, May-June 2002.
- [2] "The IAEA Activities towards Enhanced Utilization, Sustainability and Applications of Research Reactors", RRFM 2010, March 22-25.
- [3] A. GLASER, "About the Enrichment Limit for Research Reactors: why 20 %", 24th RERTR Meeting, 2005.
- [4] N. BUTLER, « Conversion of Research and Test Reactors », Last Performance, Future Plans, DOE/NNSA, 2007.

► Bibliography

- IAEA Research Reactors database, March 2010.
- IAEA Research Reactors Purpose and Future, November 2010.
- DOE/NNSA-GTRI Office of global Threat Reduction, Strategic plan, January 2007.
- CEA Future European Union Needs in Material Research Reactors (FEUNMARR). Final Report (2003), May 2009.
- SNETP Strategic Research Agenda.

Conclusion

Research reactors have been unique tools for nuclear power development. Today their role is threefold:

- Pursuing the development of present NPPs and prepare the nuclear systems of the future, and this all the more as a technological disruption step is considered;
- Producing radioelements for medicine;
- Contributing to scientific research tools for investigating matter.

As regards nuclear energy

The use of research reactors is essential to achieve:

- The selection of reactor concepts;
- The validation and qualification of the technical solutions selected;
- The evolutions and improvements of existing reactors;
- The establishment of behavior laws for materials used under irradiation.

For, despite the paramount boost of simulation, with, especially, the widespread use of Monte-Carlo-type calculations, there remain fields where experimentation is still indispensable: model readjustment, validation of basic phenomena description, and, of course, qualification of technological objects (reactors, components, fuels).

In addition, there is a constant need, increasing with the emergence of the so-called “nuclear power newcomers”, to implement small- and medium-power research reactors (SMRs) designed to foster a “nuclear culture”, with teaching and training activities, basic experiments, and derived activities such as radioisotope production.

It is a matter of fact that most of research reactors built during the nuclear power developing period, in the sixties-seventies, are rather old, even if their design, simple for most of them, has enabled them to get old in good conditions, and if they have adapted themselves to the evolution of needs.

The question of whether to upgrade or replace these reactors is now raised, in relation to the development of nuclear power and of research reactors, in expanding countries in Asia, South America, Africa and Middle East, and in “newcomers” which are developing nuclear power, or are contemplating to do so, to meet their energetic needs.

Such upgradings, replacements, and new sitings of research reactors take place in an increasingly international background for reasons of consistency and economics, as research activities in the nuclear field are increasingly organized through networks and groups spreading far beyond domestic frontiers.

In such a background, evolution outlooks are as follows:

- Regarding the most performing research reactors, *i.e.* materials test reactors and safety test reactors, which tend to become increasingly complex and costly, and have to be coupled with sophisticated experimental devices, as well as expertise means, the trend is to resort to regional or international consortia for their achievement as well as their operation, and for program achievement (see the chapter on “Outlooks of Research Reactors”);
- Regarding small and medium-sized power research reactors dedicated to teaching, training, access to nuclear techniques, an enhanced collaboration between existing reactors has been undertaken, with, presumably, a decrease in their total number and a rationalization of future achievements in this field.

These outlooks reflect general trends which are, of course, to be modulated as a function of the technical and financial capabilities of each country, its geographical situation, and its own policy.

Medical radioisotope production by research reactors

At the present time, research reactors are at the heart of the crisis relating to medical radioelements, more especially molybdenum-99, mainly produced in high-power research reactors through irradiation of highly-enriched uranium targets, and which is today used to achieve 80 % of medical diagnoses using radioelements (see above, pp. 25 and 26, the inset of

the chapter on “What are Research Reactors Used for?”, dealing with the use of artificial radionuclides in the medical sector). Resulting from the coincidence of several technical problems that occurred on producing reactors and entailed long-time shutdowns of these reactors, this crisis has evidenced the fragility of the structure for producing this radioelement.

The concertation conducted at the international level between medical authorities, research institutes, and industries has highlighted the need to start again on a sounder basis so as to:

- Rely on a network of reactors able to supply the market with sufficient redundancy;
- Be able to finance the institutions which implement irradiation reactors, at the real cost corresponding to the real services (in production capacity, availability, etc.), instead of treating this activity as accessory, as has been the case till now.

Research reactors, intense neutron sources for research

As could be seen in the first pages of this Monograph (see above, pp. 11-30, the chapter on “What are Research Reactors Used for?”, and, more precisely, the inset on neutron scattering and diffraction as a matter probe), investigating with neutrons for fundamental research displays additional features of high interest compared with the use of other radiations, due to the electrical neutrality and the mass of neutron, which help its penetration into matter and energetic exchange with light nuclei. Applications initially oriented to investigating the crystal structures of matter are now focused on soft matter, complex systems, living systems...

Nowadays, neutrons are mainly produced by research reactors specifically designed for this activity, selected among the highest performing reactors. However, another process likely to provide intense neutron sources is now increasingly used: this is the implementation of pulsed spallation neutron sources. These systems give access to intense neutron flux sources (up to 10 times those obtained in a reactor), which are pulsed. In Europe, apart from the existence of two spallation neutron sources already under operation (the ISIS source in Great Britain, and SIN Q in Switzerland), it is contemplated to build the European Spallation Source (ESS) Project, which gathers 17 partner countries, at Lund (Sweden), with a commissioning scheduled by the year 2020, and a full operational activity scheduled in 2020/2025.

For the next two decades (from 2010 to 2030), it is considered that reactors producing neutron sources for research will pursue their activities in parallel to the expansion of pulsed neutron sources, as both types of neutron sources exhibit ranges of performances and areas of excellence which are complementary.

Are research reactors a “must”?

Even if their major period of expansion is now over, they remain unique today as a support to nuclear-power-related research, as further developments are still required in this field. Besides, they have become precious tools, indeed, in both fundamental research and their industrial and medical applications.

As shown in the various chapters of this Monograph, France is endowed with a consistent fleet of research reactors able to meet the needs of present and future developments on the European scale. The evolutions scheduled and considered are intended to preserve this potential within the framework of collaborations and associations, as is already the case for the Jules Horowitz materials test reactor, whose construction today and the operation tomorrow will take place in a European infrastructure open to a high international partnership.

André CHABRE
Nuclear Energy Division

Glossary - Index¹⁹

AAS: Atomic Absorption Spectroscopy. **27.**

Accelerator-driven system (or **ADS**, also called **Hybrid system**): a hybrid reactor that couples a **subcritical*** reactor core with a high-energy proton accelerator. The latter uses **spallation*** reactions to provide the additional **neutrons*** required to maintain the **nuclear chain reaction***. **143.**

ADS: an acronym of **Accelerator-driven system***.

Amorphous: of a solid with a disordered crystalline structure. **111.**

Assembly (fuel): see **Fuel assembly***.

Atomic pile: a historical term, a former synonym for the term **nuclear reactor***.

Barrier (confinement): see **Confinement barrier***.

Beta: **delayed neutron*** fraction. **26, 128.**

Blanket: an area located in the peripheral part of a reactor core and containing fertile material. **59.**

Boiling crisis: For a **coolant*** in contact with a heated surface, the passage from **nucleate boiling*** to **film boiling*** which results in a sharp degradation of the heat transfer coefficient. In a nuclear reactor, a specific follow-up is given to boiling crisis, for this phenomenon may entail a severe damage in **fuel clad*** and so affect the integrity of the first **containment barrier***. **117.**

Boiling water reactor (BWR): a reactor in which water boiling directly takes place in the **core***. **12, 49, 51, 61-63, 80.**

BORAX: a **reactivity-initiated accident*** caused by the ejection of a **control rod*** in a pool-type research reactor. The dissemination of instantaneous power induces a steam explosion in the reactor pool which is likely to result in severe damages in the facility. The so-called "BORAX" accident is the maximum reactivity-initiated accident likely to affect a pool-type research reactor. This accident was investigated experimentally in the reactor bearing this name. **99.**

Boron-lined ionization chamber: a chamber intended for neutron detection that is based on the ionization due to alpha particles and lithium nuclei generated by the nuclear reaction of neutrons with boron. **63.**

BR2: a research reactor located at Mol (Belgium). **13, 87, 95, 136.**

Breeding gain: in a nuclear reactor operating with the U-Pu cycle, a net excess of plutonium-239 generated, *i.e.* the difference between the equivalent plutonium-239 produced through capture and the equivalent plutonium-239 destroyed through fission and capture, relative to a fission in the whole reactor. **59.**

Buckling (material and geometric): in a fundamental theory of neutronics, the flux (*i.e.* the spatial distribution of **neutrons***) is a solution of the Laplace equation. This solution shall, on the one

hand, comply with the constraints relating to the reactor shape and dimensions, and, on the other hand, take into account the features of the reactor constitutive material. These two aspects may be conveyed by an equality expressing the **critical*** condition of the system: **geometric buckling = material buckling**, where the first term is a parameter which explicits the geometric constraints, and the second, a parameter which synthesizes material's ability to regenerate neutrons. **38.**

Burnable poison: a neutron poison deliberately introduced into a reactor so as to take part in the control of long-term variations of **reactivity*** through its gradual disappearance. **49, 63, 79, 87.**

Burnup (or **burn-up**) (also called **burn-up fraction** or **burnup rate**): strictly speaking, it corresponds to the percentage of heavy atoms (uranium and plutonium) that have undergone **fission*** over a given time interval (referred to as the "**burnup fraction**"). It is commonly used to determine the thermal energy produced in a reactor per unit mass of **fissile*** material, between fuel loading and unloading operations, expressed in megawatt.days per ton (MW.d/t). (See also **Specific burnup***.) The **discharge burn-up*** is the value for which a fuel assembly must be effectively unloaded (*i.e.*, after several irradiation cycles). **37, 51, 63, 64, 79, 80-84, 87, 90, 93, 98, 115, 116, 120, 121, 132.**

Burnup rate (or **burn-up rate**): see **Burn-up***.

BWR: see **Boiling water reactor***.

CABRI: a research reactor located at Cadarache (France), used to investigate **Reactivity-Initiated Accidents***. **31, 36-40, 51, 89, 116, 117, 119-121, 132.**

Capture: the capture of a **neutron*** by a nucleus. The capture is said to be "radiative" if it is immediately followed by emission of gamma radiation. It is said to be "**fertile***" if it induces the generation of a **fissile*** nucleus. **24, 26-28, 41-43, 50, 60, 63, 64, 92.**

Cell: see **Hot cell***.

Chain reaction: see **Nuclear chain reaction***.

Clads: see also **Fuel clads***.

Collectron: see also **Self-Powered Neutron Detector***.

Confinement barrier (or **containment barrier**) **+**: a device able to prevent or limit dissemination of radioactive materials. **148.**

Containment: most of reactors are enclosed in a concrete, thick-walled building covered with a dome called "containment building". In the case of radioactive materials released in the reactor containment building, the containment retains these emissions and prevents them from being released out of the reactor. In a Canadian CANDU reactor, the core is partially housed in a concrete or steel vault. The whole structure is enclosed in a second containment about one meter thick. **118, 123-126.**

Containment barrier: see **Confinement barrier***.

Control rod: a movable rod, or group of mobile interconnected rods, containing a neutron-absorber material (boron, cadmium...), and acting on reactivity depending on its position in the core of a nuclear reactor. **15, 115-118, 120, 125, 129.**

19. Note to readers.— This set of terms and definitions is strictly intended to be a translation of the French DEN Monograph Glossary and is provided only for convenience purposes. Accordingly, the definitions herein may differ from standard or legally-binding definitions prevailing in English-language countries.

Coolant: a liquid or gas used to remove heat generated by **fissions***. In a **pressurized water reactor*** (PWR), water plays the role both of coolant, and **moderator***. **31, 57, 60, 71, 80, 102, 105, 109, 115, 120, 121.**

Core: the central area of a nuclear reactor that contains fuel assemblies, coolant and moderator and in which the **nuclear chain reaction*** takes place. **11-18, 20-22, 31, 33-38, 40, 41, 47, 49-53, 55-61, 64-66, 71, 73-82, 85, 90, 91, 93, 95, 96, 99, 102, 104, 106, 115, 116, 118-120, 123-126, 128, 131, 132, 146.**

Corium: a mixture of molten materials resulting from the accident melting of a nuclear reactor core. **118.**

Critical: of an environment in which a **nuclear chain reaction*** is maintained, during which the number of neutrons generated equals the number of lost neutrons. **9, 11, 12, 14, 31, 33-40, 47, 49-62, 64-67, 127, 135, 143.**

Criticality: a configuration characteristic of a mass of material containing fissile elements, and possibly other elements, with a composition, proportions, and a geometry such that a **nuclear chain reaction*** can be maintained within it. **60, 65, 66, 116, 117, 127, 128.**

Cross section: the measure of the probability of interaction between a particle and a target nucleus, expressed in barns (1 barn = 10^{-24} cm²). In the case of the **neutron***, for instance, this defines its probability of interaction with nuclei in the material of the various core constituents. The cross section measures the probability of occurrence of a given reaction between incident particles (e.g. neutrons) and a target (e.g. uranium nuclei). As regards nuclear reactors, the main reactions of interest are those induced by neutrons: fission, capture, and elastic diffusion. **27.**

Defense in depth: a concept in which several successive lines of defense are set in place in a nuclear facility so as to prevent the occurrence of accident situations due to technical, human or organizational failures or, if ever they occur, to limit their effects. **99.**

Delayed neutrons: neutrons* emitted by fission fragments within a few seconds' delay on the average following fission. Although they account for less than 1 % of emitted neutrons, they are those which allow reactor control *in fine* using this time delay. The delayed neutron fraction is also called "**beta***".

Discharge burnup: see **Burn-up***. **27, 33, 44, 59.**

Dissolver: a component of the process of spent fuel treatment in which the fuel is dissolved in a concentrated solution of hot nitric acid. **61-63.**

Divergence: the initiation of the **chain reaction*** process in a reactor. **16, 17, 20, 34, 36, 38, 40, 47, 49, 51, 128, 136-138.**

Doppler effect: in neutronics, the widening of neutron absorption resonances under the effect of thermal stirring of target nuclei. This effect contributes to ensure the stability of a nuclear reactor as it reduces the reactivity of its core during a temperature rise. **117, 119.**

Dosimeter (also called **dosemeter**): a device used for dose measurement. It consists of one part sensitive to ionizing radiation, and of one or several filters that allow its response to be tailored to the radioactive flux to be measured. Several physical principles of detection are used (fission chamber, ionization chamber, activation dosimeter, luminescent dosimeter...). **41, 42, 50, 53, 58, 66, 129.**

Doubling time: in the field of nuclear reactor operation, the time required for the reactor neutron flux to be multiplied by 2. In the case of a breeder reactor, the term "doubling time" also has another meaning: this is the time required for a breeder reactor to generate as much fissile material as was initially available in it. Deployment capabilities of a reactor type are characterized by this doubling time. **38, 50, 53, 59, 127.**

Dpa: Displacements Per Atom, *i.e.* the number of times that each atom of a given material sample has been ejected from its site under irradiation. This is an appropriate unit to quantify irradiations in metals. **12, 96, 102, 104, 110.**

Effective full power days: see **EFPD***.

Effective multiplication factor (k_{eff}) (also called effective multiplication constant): see **Multiplication factor***.

EFPD, ERPD: units of reactor operating time respectively expressed as "Effective Full Power Days" (EFPD) and "Effective Rated Power Days".

Epithermal neutrons: neutrons located in an approximate 1 eV*-20 keV energy range which thus display a higher velocity than **thermal neutrons***. In this energy range, neutron-nucleus interaction cross sections are affected by the presence of resonances, and may so vary by several orders of magnitude. **27.**

Fast neutron reactor (or **fast reactor**): referred to in French as "RNR" (standing for *Réacteurs à Neutrons Rapides*). A reactor with no moderator in which most of fissions are generated by **neutrons*** displaying energies of the same order of magnitude than their initial energy on their generation by fission. **31, 35, 37, 55, 58, 59, 84, 109, 118-120, 143, 144.**

Fast neutrons: neutrons* released during fission which move very quickly (20,000 km/s). Their energy is about 2 million electronvolts.

Fast reactor: see **Fast neutron reactor***. **29, 101, 103.**

Fertile: refers to a material the nuclei of which yield **fissile*** nuclei when they absorb neutrons. This is the case with uranium-238, which yields plutonium-239. Otherwise, the material is said to be sterile. **55, 57, 59.**

Fissile: refers to a nucleus capable of undergoing **fission*** through **neutron*** absorption. Strictly speaking, it is not the so called "fissile" nucleus that undergoes fission, but rather the compound nucleus formed after neutron capture. **6, 43, 49, 50, 55, 57-59, 65, 96, 97, 101, 104, 115, 116, 127, 128, 149.**

Fission: the splitting of a heavy nucleus into two fragments of approximately equivalent masses. This transformation, a special case of radioactive decay in some heavy nuclei, releases a large amount of energy and is accompanied with neutron and gamma radiation emission. The fission of the so-called "**fissile***" heavy nuclei can be induced by a collision with a neutron. **9, 11, 22, 24, 25, 34, 37, 39, 41-44, 50, 52, 53, 58-60, 63-66, 71, 74, 81, 82, 84.**

Fission chamber: an ionization chamber used for neutron detection, in which ionization results from the fission products induced by the nuclear reaction of neutrons on a fissile material deposit. **34, 38, 42, 43, 50, 52, 53, 58, 83.**

Fission products (FPs): nuclides* generated either directly through nuclear fission, or indirectly through disintegration of fission fragments. **37, 38, 43, 50, 59, 60, 63, 64, 71, 81-84, 90, 96, 101, 104, 115, 118, 123, 125, 126, 128, 131, 132.**

Fission rate: the proportion of nuclei that has undergone a **fission*** reaction in a population of nuclei subjected to a given irradiation. **43, 50, 52, 53, 59, 60.**

Fluence: a dose unit used to quantify materials irradiation. This is the number of particles (for example neutrons) brought by unit area during irradiation. **109, 110, 129.**

FPs: see **Fission products***.

FR: Fast Reactor. See **Fast Neutron Reactor***.

Fuel assembly (or **assembly**): in the core of a water-cooled reactor, fuel rods are grouped into clusters of suitable stiffness which are set in place with a definite position in the reactor core. The so-

called “assembly” is that structure as a whole, gathering from 100 to a few hundred rods, which is loaded into the reactor as a single unit. [9](#), [11](#), [47](#), [51](#), [53](#), [55-57](#), [59-62](#), [65](#), [66](#), [71](#), [78](#), [97](#), [116](#), [117](#), [119](#), [123](#), [124](#).

Fuel clad (also called **clad** or **cladding**): the sealed envelope surrounding the fuel, intended to ensure its containment and mechanical resistance in the reactor core. [43](#), [51](#), [52](#), [54](#), [71](#), [75](#), [79](#), [80](#), [81](#), [84](#), [90](#), [97](#), [98](#), [102](#), [104](#), [106](#), [116](#), [117](#), [119](#), [121-125](#), [131](#).

Gamma heating: see **Gamma-induced heating***.

Gamma-induced heating (also called **gamma heating**): a heating taking place in the core of a reactor as a result of the absorption of gamma photons emitted during nuclear reactions. [53](#), [58](#), [59](#), [73](#), [76](#), [79](#), [80](#), [104](#).

Gamma scanning: a nondestructive examination through **gamma spectrometry*** intended to follow up the nuclear reaction rate in a reactor **core*** performing post-irradiation measurements on the fuel elements of the core. [50](#).

Half-life (radioactive): see **Radioactive half-life***.

Heavy-water reactor (HWR): a nuclear reactor in which the **moderator***, and usually the **coolant***, are heavy water.

HFR: a high-flux research reactor located at Petten (Netherlands).

Hot cell: a containment intended for radioactive materials treatment which ensures containment and radiation protection with shielded walls. [13](#), [24](#), [73](#), [77](#), [83](#), [87](#), [96](#).

Hybrid system: see **Accelerator-driven system***.

HWR: see **Heavy-water reactor***.

ICP-MS: Inductively-Coupled Plasma Mass Spectrometry.

Inconel: an austenitic alloy of nickel, chromium and iron much used in water-cooled reactors due to its good resistance to corrosion.

Infinite multiplication factor (k_{∞}) (also called **infinite multiplication constant**): see **Multiplication factor***.

Integrated flux: see also **Fluence***.

Irradiation cycle: the operating period of a reactor between two successive fuel reloading operations. In France the irradiation cycles of nuclear power reactors are of 12-18 months. [74](#), [75](#).

ITU: Institute for Transuranian Elements (ITU). A European laboratory set up at Karlsruhe.

JANNUS: a research tool platform including particle accelerators and characterization tools for studying materials under irradiation. [108](#), [111](#).

LECA: a hot laboratory located at Cadarache for studying irradiated fuels. [84](#), [88-90](#).

LECI: Laboratory for irradiated fuels and materials studies (CEA/Saclay). [84](#), [87-90](#).

LEFCA: a laboratory for fuel fabrication or refabrication located at Cadarache. [88](#), [89](#).

Light water reactors (LWR): a reactor family which gathers **pressurized water reactors*** and **boiling water reactors***. [35](#), [40](#), [49-51](#), [62](#), [63](#), [81](#), [105](#), [106](#), [131](#).

Linear power density: power generated per unit length of active fuel rod*. [80](#), [81](#), [83](#), [92](#).

LOCA (also called **Loss of coolant accident**): this type of accident is retained as a design-basis criterion for water-cooled reactor safety owing to the related risks of fuel failure and radioactivity release. [101](#), [115](#), [117](#), [121](#), [122](#), [131](#), [132](#).

Loss of coolant accident: see **LOCA***.

Minor actinides: heavy nuclei formed in a reactor through successive **neutron captures*** from fuel nuclei. These **isotopes*** mainly are neptunium (237), americium (241, 243), and curium (243, 244, 245). [64](#), [81](#), [87-89](#).

Mixed OXide fuel: see **MOX fuel***.

Moderating ratio: in **fissile*** material, the ratio between the **moderator*** volume and the fissile material volume. [51](#), [52](#).

Moderation: a process likely to help slow down neutrons in order to bring them progressively to a thermal equilibrium with the matter in which they are scattered. [51](#), [53](#), [58](#).

Moderator: a material formed with light nuclei which make **neutrons*** slower through elastic collisions. Moderators are used to reduce the energy of neutrons emitted by uranium atoms during fission, so as to increase their probability to induce other fissions. The moderating material has to be little absorbing to avoid “wasting” neutrons, and to be sufficiently dense to allow for an efficient **moderation***. [21](#), [22](#), [33](#), [34](#), [49](#), [52](#), [57](#), [59](#), [61](#), [65](#), [66](#), [116](#).

Monte-Carlo method: a statistical method for approximating the value of an integral by using a set of dots randomly distributed according to a certain probability. It consists in repeating the assignment of a digital value depending on the progression of a process in which hazard is involved, then calculating an average and its statistical dispersion (as an expression of its accuracy) on all of the values collected. In the field of particle transport in matter, this method consists in simulating the path of a very high number of particles taking precisely into account the geometry and nuclear interactions, and then computing the results of interest.

MOX fuel (also called **Mixed OXide fuel**): a nuclear fuel containing Mixed OXides of (natural or depleted) uranium and plutonium. [29](#).

MTR (Material Test Reactor): a research reactor dedicated to investigating the behavior of materials and fuels under irradiation. [36](#), [49](#), [61](#), [85](#), [95](#), [96](#), [99](#), [101](#), [105](#), [143](#).

Multiplication factor (infinite k_{∞} and **effective k_{eff}**): the average value of the number of new **fissions*** induced by the **neutrons*** generated by an initial fission. If the multiplication factor is of infinite dimensions, and so without neutron leakage, this factor is known as the “infinite multiplication factor” and is noted k_{∞} . In the opposite case, it is said to be “effective”, and is noted k_{eff} . [34](#).

NaK: a coolant used in the devices of some research reactors which consists of a liquid sodium-potassium eutectic at room temperature. [13](#), [41](#), [80](#), [84](#), [104](#).

Neutron: an electrically neutral fundamental particle of a $1.675 \cdot 10^{-27}$ kg mass. The nature of this nucleon was discovered in 1932 by the British physicist James Chadwick. Neutrons, together with protons, constitute atomic nuclei and induce fission reactions of fissile nuclei, the energy of which is used in nuclear reactors.

Neutron (slow or thermal): a **neutron*** in thermal equilibrium with the matter in which it moves with a velocity of about 2-3 km/s. Its energy is lower than 1 eV.

Neutron absorber: a material likely to absorb **neutrons*** through a reaction of **neutron capture***. [51](#), [64](#), [79](#).

Neutron flux: the number of neutrons which go through a unit area by unit time. [11](#), [13](#), [17](#), [22](#), [23](#), [27](#), [42](#), [43](#), [73](#), [76-80](#), [95](#), [96](#), [99](#), [102](#), [104](#), [108](#), [131](#), [132](#), [143](#), [146](#).

Neutron poisons (also called **poisons**): elements displaying a high potential for **neutron*** capture, used to compensate, at least in part, excess **reactivity*** in **fissile*** media. Four natural elements are particularly neutron-absorbing: boron (due to its **isotope*** ^{10}B), cadmium, hafnium, and gadolinium (due to its isotopes ^{155}Gd and ^{157}Gd). Some poisons are referred to as “burnable” poisons,

because they gradually vanish during in-pile burnup. **Fission products*** are neutron poisons. They absorb neutrons. **49, 63, 79, 87.**

Neutron radiography: a radiography sensitive to light elements which is performed using **neutrons***. **19, 22, 28, 80, 83, 91.**

Neutron spectrum: the energy distribution of the neutrons occurring in the core of a reactor. **52, 59, 60, 62, 66, 79.**

Neutronics: the study of the paths followed by **neutrons*** in **fissile*** and nonfissile media, and of the reactions they induce in matter, in particular in nuclear reactors, with regard to their multiplication, and the initiation and control of the **nuclear chain reaction***. **11, 12, 15, 17, 23, 31, 34, 37, 38, 41, 42, 58, 60, 66, 82-84, 103, 104, 135.**

Nuclear chain reaction (or chain reaction): a series of nuclear **fissions*** during which released **neutrons*** generate new fissions, which, in turn, release new neutrons generating new fissions, and so on. **127.**

Nuclear reactor: a device in which a **nuclear chain reaction*** may be initiated, maintained and controlled. Its essential components are fissile fuel, **moderator***, shielding, **control rods*** and **coolant***. **29, 44, 71.**

Nuclide: a nuclear species characterized by its number of protons Z, its number of **neutrons*** N and its mass number A, equal to the sum of proton number and neutron number ($A = Z + N$).

OSIRIS: a research reactor located at Saclay and dedicated to investigating materials and fuels under irradiation. **13, 15, 26, 27, 30, 31, 36, 37, 40, 44, 73-77.**

Pellet-Clad Interaction (PCI): the mutual influence between fuel pellets and **fuel clad***. The mechanical contact between these two components induces high constraints in the clad, which can result in its failure, with stress corrosion as the prominent mechanism. **80, 106.**

PHÉBUS: a research reactor for studying **loss of coolant accidents***. **31, 37, 40, 51, 88, 116-118, 123, 124.**

PIXE: Proton-Induced X ray Emission. This analytical technique consists in measuring the spectrum of X-rays emitted by a target bombarded by protons. It gives information about the elemental composition of the target. **110.**

Pressure tube: a CANDU reactor contains hundreds of separate zirconium alloy tubes under pressure. Each pressure tube contains 12 or 13 natural uranium fuel rods in which hot heavy-water coolant goes through for heat removal. Each pressure tube is surrounded by low-temperature heavy water, while being separated from it by a thin-wall vessel tube. The space between neighboring vessel tubes is filled with heavy water. **123.**

Pressurized Water Reactor (PWR): a reactor in which heat is transferred from the core to the heat exchanger by water kept at high pressure in the **reactor coolant system*** in order to prevent its boiling. **36, 37, 49, 51, 115, 117, 119-121, 124.**

Primary coolant circuit: see **Reactor coolant system***.

Primary cooling system: see **Reactor coolant system***.

Primary system: see **Reactor coolant system***.

Proliferation: an uncontrolled dissemination of military nuclear technologies, or of materials used by these technologies. **87, 97, 139.**

Prompt neutrons: **neutrons*** directly emitted at the very moment of **fission***. **65, 66, 117.**

PSI: Paul Scherrer Institut. A Swiss organization for nuclear research. **88, 106.**

PWR: see **Pressurized Water Reactor***.

Quench: the cooling of a metal or an alloy which is often fast and, generally, deliberate and controlled. Quench impacts on the material's crystalline structure as well as on its mechanical characteristics. **116, 122, 132.**

Radioactive half-life: the time it takes for half the initial number of atoms in a radioactive nuclide sample to disappear by spontaneous decay. The radioactive half-life is a property characterizing every radioactive isotope. **28, 42.**

Radionuclide: an unstable **nuclide*** of an element which spontaneously decays emitting radiation. **78, 84, 140, 146.**

RAMAN spectrometry: the spectrum of light scattered by a substance illuminated with a monochromatic infrared radiation exhibits rays that result from coupling between the emitted radiation and the vibrations and rotations of the molecules which it goes through (Raman effect). Analyzing these rays brings information about the molecules in the substance. **110.**

RBS: Rutherford Back Scattering. This analytical technique consists in analyzing the backscattering of alpha particles sent onto a sample. It gives access to the local composition of the sample in the neighboring of its surface. **110.**

Reactivity Insertion Accident: see **Reactivity-Initiated Accident.**

Reactivity: a no-dimension quantity which allows small variations of the **multiplication factor*** k to be assessed around the critical value and which is defined by the formula $\rho = (k - 1)/k$. As its value is very small, it is generally expressed in hundreds of thousandths, taking the percent thousand as a unit. In a reactor, reactivity is nul when the reactor is **critical***, positive when it is **overcritical***, and negative when it is **subcritical***. **14, 31, 33, 34, 37, 38, 41, 49, 53, 54, 59-61, 63-65, 75, 89, 99, 115, 117-121, 127, 128, 132.**

Reactivity-Initiated Accident (also called Reactivity Insertion Accident or RIA): an accident induced by an uncontrolled increase in the reactivity of a nuclear reactor core. **99.**

Reactor coolant system (also called primary coolant circuit, primary cooling system, primary system): a closed loop system or a set of closed loops which allows heat to be removed from **fuel elements*** in the **reactor core***, through circulation of a **coolant*** in direct contact with those fuel elements. **12-14, 71, 74, 75, 77, 96, 99, 104, 105, 115, 116, 118, 123.**

Reactor vessel (also called vessel): a vessel that contains the core of a reactor and its coolant. **11, 12, 18, 21, 40, 49-52, 59, 71, 75, 78, 79, 87, 88, 90, 118, 119, 123, 126, 127.**

Recycling (or recycle): the reuse in a reactor of nuclear materials derived from spent **fuel treatment***. **51, 62, 63, 81, 87, 128.**

Reflector: a reactor component positioned near the core to send it back leakage neutrons. **21, 51-53, 57, 59, 60, 61, 74, 77, 97, 99, 102, 131, 132.**

Reprocessing: see **Treatment (of spent fuel)*.**

Residual power: the thermal power generated by a nuclear reactor at shutdown, arising mainly from **fission products* activity***. **19, 29, 77, 82-84, 116, 118, 144.**

Resistivity annealing: a technique for analyzing a metal sample which consists in measuring its resistivity after annealing at various temperatures. This technique informs about the type of crystal defects occurring in the solid. **110.**

Resonance integral: the average value of the reaction cross section in the field of resonance energies. **27, 34, 62.**

RIA: see **Reactivity-Initiated Accident*.**

Screening: a type of experiment in which one or several parameters are systematically varied in order to study their effects. **101, 104.**

Self-Powered Neutron Detector (SPND) (or collectron): a neutron or gamma radiation detector with no external power source which emits a signal resulting from electron emission by an electrode following neutron capture or gamma photon absorption. [42](#), [43](#), [81](#).

SIMS: Secondary-Ion Mass Spectrometry. A powerful method for analyzing the elemental composition of a material's surface. [88](#), [89](#).

Spallation: a nuclear reaction in which are involved a heavy target nucleus and a particle, most often a proton, which is accelerated up to an energy of a few hundred millions of **electronvolts***. By successive collisions against the nucleons of the target nucleus, the incident particle expels a high number of **neutrons***, among other particles. Thus, a proton of 1 billion electronvolts propelled onto a lead target may generate from 25 to 30 neutrons. [20](#), [23](#), [60](#), [87](#), [143](#), [146](#).

Specific burnup (also called **specific burn-up** or **burn-up rate** or **burn-up**): the total energy released by unit mass in a nuclear fuel. Generally expressed in megawatts x days per ton (MW-d/t). See also **Burnup***. [81](#).

Spectrometry: measuring and interpreting of quantity spectra relating to the physical or chemical constituents of a body or to the analysis of a wave. For example, mass spectrometry is based on the separation of the atoms or molecules of a body according to their mass. Gamma spectrometry consists in measuring gamma radiation energy emitted by a source. It informs about the nature and activity of the radionuclides occurring in this source. [13](#), [17](#), [26](#), [42](#), [50](#), [52](#), [53](#), [80](#), [81](#), [84](#), [110](#).

Spent fuel treatment: see **Treatment** (of spent fuel).

Spin: the intrinsic angular momentum of a quantum object. Sometimes the use of the word spin is restricted to particles considered to be elementary. [19](#).

Steam generator (SG): In a nuclear reactor, an exchanger that allows heat transfer from the primary coolant to the water of the secondary coolant circuit, and turns it into steam to drive the turbo-generator. [18](#), [110](#), [123](#), [124](#).

Subcritical: in neutronics, of a multiplying medium in which the number of **neutrons*** emitted by **fission*** is lower than the number of neutrons vanishing by absorption and leakage. In this case, the number of fissions observed during successive time intervals decreases, and the **chain reaction*** cannot be maintained in the medium without additional neutrons from an outside source. For example, there exist planned subcritical reactors in which the additional neutrons are brought to the reactor core by an accelerated particle beam. The interest of these reactors lies in their high capability for actinide **transmutation***. [14](#), [47](#), [50](#), [59](#), [60](#), [62](#), [143](#).

Supercritical: a system in which the number of **neutrons*** emitted by **fission*** is higher than the number of neutrons vanishing by absorption and leakage. In this case, the number of fissions observed during successive time intervals increases. [65](#), [66](#).

Temperature coefficient: a coefficient which expresses the variation of the neutron **multiplication factor*** in a reactor when its temperature changes. A negative temperature coefficient is an important criterion of core stability. [49](#), [53](#).

Test loop: an experimental device dedicated to specific studies under dynamic or recirculation conditions (closed loop, purification, desired conditions maintained). [119](#), [120](#).

Thermoluminescence: a process by which some substances pre-irradiated emit a luminous radiation under thermal stimulation. This physical phenomenon makes it possible to trace back to the dose received by an object. [18](#), [34](#), [61](#), [87](#), [88](#), [128](#), [140](#), [144](#).

Toughness: a characteristic quantity for a material, expressed in MPa.m^{1/2}, a measure of its resistance to crack propagation. [79](#).

TR-XRF: Total Reflexion-X-Ray Fluorescence. [27](#).

Transmutation: the transformation of one **nuclide*** into another through a nuclear reaction. Transmutation considered in relation to radioactive waste management aims at converting a long-lived nuclide into a shorter-lived or stable nuclide. See also **radioactive half-life***. [23](#), [24](#), [28](#), [29](#), [37](#), [41](#), [59](#), [60](#), [107](#), [109](#), [143](#).

Transmutation target: a material inserted into a reactor core or a particle accelerator beam in order to turn a significant part of its atoms into other elements through nuclear reactions. [23](#), [59](#), [60](#), [142](#).

Treatment (of spent fuel) (also called **reprocessing** or **spent fuel treatment**): an operation that consists in separating valuable materials in spent fuel from the remainder, which can be then considered as waste and conditioned accordingly. [7-10](#).

Undermoderated: of a multiplying medium, the reactivity of which increases with the **moderating ratio***. [62](#), [63](#), [96](#).

UNGG: a French acronym for *Uranium Naturel-Graphite-Gaz*, used to refer to the natural-uranium, graphite-moderated and (CO₂) gas-cooled reactor system. [34](#), [35](#), [39](#), [40](#).

UOX: the standard **light-water reactor*** fuel, consisting of uranium-235-enriched* uranium oxide. [47](#), [51](#), [53](#), [63](#), [64](#), [81](#).

Uranium oxide fuel: see **UOX***. [47](#), [51](#), [53](#), [63](#), [64](#), [81](#), [120](#).

VERCORS: a research program conducted at the CEA to investigate nuclear fuel behavior and **fission products*** release in the case of a severe accident. [118](#).

Void coefficient: a coefficient which expresses the variation in the **multiplication factor*** of a reactor when more voids (*i.e.* areas of lower density, such as bubbles) are formed in the **coolant*** than in normal conditions. If this coefficient is positive, a void increase will result in increased **reactivity*** and, so, increased power. In contrast, if negative, the void increase will tend to bring the reactor to shutdown. [117](#).

Void effect: the variation in the **multiplication factor*** of a reactor when more voids (*i.e.* areas of lower density, such as bubbles) are formed in the **coolant*** than in normal conditions. If the **void coefficient*** is positive, a void increase will result in increased **reactivity*** and, so, increased power. This void effect is an important element to be taken into account in relation to the stability and safety of nuclear reactors. [59](#).

VTT: Finnish technological research center. [87](#).

Zircaloy: an alloy of zirconium and one or several other metals (tin, iron, chromium, nickel), which displays outstanding mechanical strength and chemical resistance. It is used for water-cooled reactor **fuel clads***. [116](#), [123](#).

Table of Contents

Foreword	5
Research Reactors, their Use and History	7
What are Research Reactors Used for?	11
How to define them?	11
Research reactors and nuclear power: critical mockups, materials test reactors, safety test reactors, training reactors, prototypes	11
Research reactors: tools for the benefit of basic research, industry and health.	
Neutron diffraction, isotope production, neutron activation, neutron radiography and semiconductor doping	19
French Research Reactor History	33
ZOÉ, the first French atomic pile, started operation in 1948	33
The fifties or the study of the early reactor types	33
The flourishing age of the sixties	35
The seventies' major achievements	37
What about the future of research reactors?	37
Instrumentation for Research Reactors	41
Neutron measurements	42
Thermal measurements	43
Mechanical measurements	44
Fission gas release measurements	44
Validating Neutronics Calculations	45
The Water Critical Mockup ÉOLE	49
Objectives of the ÉOLE critical mockup, and facility description	49
Experimental techniques used on the ÉOLE mockup	50
Experimental programs of the ÉOLE mockup	51
MASURCA: an Air Critical Mockup Dedicated to Fast Neutron Reactor Study	55
MASURCA objectives and facility description	55
MASURCA experimental programs	58
The Water Critical Mockup MINERVE	61
Objectives of the MINERVE reactor and facility description	61
Experimental programs of the MINERVE mockup	62
CALIBAN: a Pulsed Research Reactor	65
Objectives of the CALIBAN reactor and facility description	65
CALIBAN applications	66
Testing Materials under Irradiation	69
The OSIRIS Reactor	73
Why the OSIRIS reactor?	73
OSIRIS design	73

OSIRIS operation	75
OSIRIS reactor safety	76
Conducting experiments	77
Industry applications	78
Irradiation experiments to investigate materials	78
Irradiation experiments to investigate nuclear fuels	80
Irradiation experiments for Generation IV reactors	84
The Laboratories Associated with Research Reactors	87
Areas of activity of hot laboratories	87
Hot laboratories in Europe	88
Hot laboratories at the CEA	89
Types of examination conducted in CEA's hot laboratories	89
An example of research using hot laboratories: REMORA experiments to investigate fuel behavior under incident conditions	90
The Jules Horowitz Reactor	95
Launching the JHR Project	95
The JHR design	96
Experimental Programs and Related Devices in the Jules Horowitz Reactor	101
Purpose of the JHR	101
Experiment types in the JHR	101
An experiment-oriented JHR design	102
Experimental hosting devices in the JHR	103
A European project to investigate materials under irradiation	105
Irradiating Materials with Ion Beams	107
Simulating neutron irradiation with ion irradiation	107
The JANNUS multi-ion beam platform	108
Research topics approached using the JANNUS platform	109
Investigating Accident Situations	113
Loss of cooling accident	115
Reactivity-Initiated Accident	117
Severe accident	118
The CABRI Research Reactor for Studying Reactivity-Initiated Accidents	119
Objectives of the CABRI reactor, and facility description	119
Tests in CABRI	120
Future experiments in CABRI	121
The PHÉBUS Research Reactor for Studying Loss of Coolant Accidents	123
Objectives of the PHÉBUS reactor, and facility description	123
Tests in PHÉBUS	124
The SILENE Reactor for Studying Criticality Accidents	127
Criticality accidents	127
The SILENE reactor	127
Outlooks for Research on Accident Situations with the Jules Horowitz Reactor	131
Loss of cooling situations	131
Overpower situations	132

Worldwide Overview of Research Reactors	133
Research Reactors in the World	135
The status of the research reactor fleet	135
Features of the research reactor fleet and related problems	139
What about the future of research reactors?	140
Conclusion	145
Glossary - Index	147

Contributors to this Monograph:

André Chabre (Topic Editor)
Alain Alberman,
Michel Auclair,
Nicolas Authier,
Daniel Beretz,
Gilles Bignan,
Jean-Yves Blanc,
Bernard Bonin,
Jean-Christophe Bosq,
Xavier Bravo,
Pascal Chaix,
Jean-Marc Costantini,
Gérard Ducros,
Philippe Durande-Ayme,
Jérôme Estrade,
Philippe Fougeras,
Danielle Gallo,
Christian Gonnier,
Lionel Gosmain,
Daniel Iracane,
Jean-Christophe Klein,
Thierry Lambert,
Patrick Lemoine,
Richard Lenain,
Stéphane Loubière,

Clarisse Mariet,
Loïck Martin-Deidier,
Frédéric Mellier,
Alain Menelle,
Sandrine Miro,
Emmanuelle Muller,
Joseph Safieh,
Philippe Jucker,
Henri Safa,
Stéphanie Sorieul,
Patrick Trocellier,
Caroline Verdeau,
Jean-François Villard,
Alain Zaetta.

... along with, of course, all the members of
the DEN Monographs Editorial Board:

Bernard Bonin (Editor in chief),
Martine Dozol (CEA Cadarache Center),
Michaël Lecomte (CEA Valhro Center),
Marie-José Lovérini (Communication
Division),
Alain Forestier (CEA Saclay Center).