



HAL
open science

Gas-cooled nuclear reactors

Pascal Anzieu, Bernard Bonin, Philippe Pradel

► **To cite this version:**

Bernard Bonin, Philippe Pradel (Dir.). Gas-cooled nuclear reactors. Pascal ANZIEU. CEA Saclay; Groupe Moniteur, 2006, E-den, Une monographie de la Direction de l'énergie nucléaire, CEA, 978-2-281-11343-3. cea-01151547

HAL Id: cea-01151547

<https://cea.hal.science/cea-01151547v1>

Submitted on 13 May 2015

HAL is a multi-disciplinary open access archive for the deposit and dissemination of scientific research documents, whether they are published or not. The documents may come from teaching and research institutions in France or abroad, or from public or private research centers.

L'archive ouverte pluridisciplinaire **HAL**, est destinée au dépôt et à la diffusion de documents scientifiques de niveau recherche, publiés ou non, émanant des établissements d'enseignement et de recherche français ou étrangers, des laboratoires publics ou privés.

Commissariat à l'énergie atomique

e-den

A monograph of the Nuclear
Energy Directorate

Gas-cooled nuclear reactors

DEN monographs

A monograph of the Nuclear Energy Directorate
Commissariat à l'énergie atomique,
91191 Gif-sur-Yvette Cedex.
Tel.: +33-1 64 50 10 00

Scientific comitee

Michel Beauvy, Georges Berthoud, Mireille Defranceschi,
Gérard Ducros, Yannick Guérin, Yves Limoge, Charles Madic,
Gérard Santarini, Jean-Marie Seiler, Pierre Sollogoub,
Étienne Vernaz, Directeurs de Recherche.

Thematic supervisor: Pascal Anzieu.

The following people participated in this work:

Pascal Anzieu, Bertrand Barré, Florence Bart, Michel Beauvy,
Philippe Billot, Jean-Pierre Bonal, Bernard Bonin, Bernard Boullis,
Jean-Louis Boutard, Jean-Claude Brachet, Hélène Burlet,
Jean-Louis Carbonnier, Marc Delpech, Patrick Dumaz,
Sophie Ehster, Gian-Luigi Fiorini, Jean-Louis Flèche,
Jean-Claude Garnier, Jean-Paul Grouiller, Michel Guttmann,
Michaël Lecomte, Yves Limoge, Bernard Marini, Philippe Martin,
Michel Masson, Xavier Raepsaet, Cécile Reynaud,
Jean-Charles Robin, Nicolas Tauveron, Anne Terlain,
Jean-Baptiste Thomas, Alain Vallée.

Editorial Director: Philippe Pradel.

Editorial Board: Bernard Bonin (Managing editor),
Bernard Bouquin, Martine Dozol, Michel Jorda,
Jean-Pierre Moncouyoux, Alain Vallée.

Administrator: Fanny Bazile.

Editor: Jean-François Parisot.

Graphic concept: Pierre Finot.

Correspondence: all correspondence can be addressed
to the Editor or to CEA/DEN Direction scientifique, CEA Saclay
91191 Gif-sur-Yvette Cedex.
Tel.: + 33-1 69 08 16 75.

© CEA Saclay et Groupe Moniteur (Éditions du Moniteur),
Paris, 2006

ISBN 2-281-11343-4

The information contained in this document can be freely
reproduced, with the agreement of the Editorial Board
and due mention of its origin.

Preface

After a dazzling start in the 1950s as a promising, inexhaustible, cost-effective energy source, nuclear energy was rejected by majority opinion in several countries in North America and Western Europe three to four decades later, suddenly bringing its development to a halt.

Although the 1973 and 1979 oil crises marked the beginning of massive construction programmes in the countries most heavily penalized by oil imports, France and Japan in particular, they were paradoxically followed by a gap in nuclear spending, first in the United States and then in Western Europe. However, more recent oil market tensions and emerging concerns over non-renewable natural resources should have increased such spending.

There are surely many reasons for this pause, which can in part be explained by the accidents in Three Mile Island in 1979 and Chernobyl in 1986, which deeply impacted public opinion. On top of this, ecological movements and Green parties made their (highly publicized) fight against nuclear energy a key part of their platform.

In France, whose population, with the exception of one case, had never disputed nuclear plant construction, negative attitudes began to surface in the late 1980s concerning the nuclear waste issue. Given Andra's growing difficulties in finding an underground laboratory site, the Government decided to suspend work in favour of a one-year moratorium and submitted the issue to the OPECST (French parliamentary evaluation office for scientific and technological choices).

The Act of 30 December 1991 on nuclear waste management implemented the essence of the OPECST's recommendations, in particular its definition of a diversified research programme and the basis for democratic discussion, thus helping calm the debate. That said, although it is now an accepted fact that long-term nuclear waste management is a necessity, there is still no guarantee that France will continue its electronuclear programme: for this reason, the recent energy act of 13 July 2005 merely aimed to "keep nuclear options open through 2020".

However, this century should be marked by renewed collective awareness that our generation's energy needs cannot be met without concern for the environment and without preserving future generations' rights to satisfy these same needs. This concept of sustainable development is an inevitable challenge to our society.

Today, it goes unquestioned that global warming due to increasing greenhouse gas emissions is a human-caused problem. The only remaining debate concerns the consequences of this climate change. Industrialized nations, which are for the most part responsible for the current situation, should feel particularly obliged to voluntarily take steps towards reducing emissions of these gases. Nuclear energy should gain considerable ground since, by nature, it does not produce this type of emissions and yet is an abundant, reliable and cost-effective energy source.

The situation varies from country to country. On one hand, European countries such as Germany and Belgium have chosen to progressively stop using nuclear energy, even without making plans for reversibility. On the other hand, countries like China, South Korea, or,

closer to home, Finland, are making huge investments in developing this technology. Furthermore, according to a recent statement by President Bush, the United States has decided to launch new nuclear power plant construction projects over the next ten years, picking up a process that had been on hold for over a quarter-century.

Following France's national energy debate that took place in the first half of 2003, the parliamentary bill on energy adopted in June 2005 established the decision to build a demonstrator EPR in preparation for the switchover when currently operating plants will be shut down.

Several signs lead us to believe that there could soon be a nuclear energy "renaissance", especially if the barrel of crude stays at or above the 70 USD mark. Nevertheless, the future of nuclear energy in our country, as in many others, will depend largely on its capacity to properly address the following two concerns:

- First, its social acceptability: nuclear energy must be deployed under stringent safety and security conditions, generating as little final waste as possible, with perfect control of the waste that is produced in terms of its possible impact on human health and the environment.
- Secondly, the availability of nuclear resources: it is important to guarantee a long-term supply of fuel, by preparing to resort to more economical natural fissile material systems which are less dependent on market fluctuations.

These topics are a key part of the CEA Nuclear Energy Division's work. Indeed, this division is a major player in the research that aims to support the nuclear industry's efforts to improve reactor safety and competitiveness, providing the Public Authorities with the elements necessary for making decisions on the long-term management of nuclear waste, and, finally, developing the nuclear systems of the future, essentially fast neutron reactors, which offer highly promising innovations in waste management and raw material use.

As a fervent partisan of sharing as much scientific and technical knowledge as possible to a broad public, I believe that this research work, which calls upon a diverse array of scientific disciplines often at top worldwide level, should be presented and explained in priority to anyone who would like to form their own opinion on nuclear energy. For this reason, it is with great satisfaction that I welcome the publication of these DEN monographs. Through close reading of these works, they can become an invaluable source of information for the, I hope, many readers.

I would like to thank all the researchers and engineers who, by contributing to this project, helped share their experience and knowledge.

Bernard BIGOT
High Commissioner for Atomic Energy

Introduction

The challenges of future nuclear systems

Nuclear energy production is a recent technology. The first nuclear reactor demonstrating the feasibility of a sustained and controlled chain reaction was built in Chicago in 1942. In 1957, a nuclear reactor produced electricity for the first time. For the past 50 years, significant technological progress has been achieved.

Three generations of nuclear reactors have been successively developed and a fourth is currently being developed, demonstrating the constant progress and technical and industrial vitality of nuclear energy. The technology is mature, with approximately 450 nuclear reactors currently providing 17% of the world's electricity, without greenhouse gas emissions.

It must also be stressed that the technological progress and innovations achieved or currently being developed are all based on the same fundamental physical principles of nuclear fission, whose feasibility was demonstrated 60 years ago. Heavy nuclei are fissioned by neutrons and release heat within the fuel material confining the radioactivity. This heat is extracted while simultaneously cooling the fuel by circulating a coolant (water in current French reactors). The heat recovered is used to run a turbine and a generator, which produces electricity.

Progress of 4th generation nuclear systems

What progress is expected from 4th generation nuclear systems?

Optimal use of natural resources and minimisation of waste

These objectives address the challenges of sustainable energy production, *i.e.*, using fuel far more efficiently and significantly reducing the volume and potential radiotoxicity of radioactive waste. Regarding fuel consumption, the objective is to use 50 to 70% natural uranium (current water-cooled reactors use only 1%) and thus ensure a sustainable use of nuclear energy compatible with the uranium resources currently available.

Regarding radioactive waste, the objective is to reduce to a few hundred years the time needed to reach the radiotoxicity level of the original uranium ore.

In order to achieve such progress, it is necessary to recycle all valuable materials (fissile heavy actinide nuclei, uranium, transuranians - plutonium, americium, curium, neptunium) for subsequent fission and energy production, and to only consider as final waste (*i.e.*, fission products whose radiotoxicity decreases far more rapidly) the ultimate radioactive waste. The capacity of 4th generation nuclear systems to recycle and consume the actinides (Pu, Np, Am, Cm) produced by 2nd and 3rd generation water-cooled reactors is also an important factor.

In addition, the neutron energy within the reactor must be increased so as to consume all recycled heavy nuclei.

The nuclear reactor is only one of the components of the system to be implemented in order to achieve these objectives. It must be associated with fuel cycle plants capable of producing the necessary fuel and reprocessing it after its passage through the reactor. This is why we use the term 4th generation system (reactor/fuel/fuel cycle) rather than reactor.

Proliferation resistance

It must be stressed that such a fuel cycle (*i.e.*, global recycling of actinides) is highly proliferation-resistant, since all fissile materials are processed together and recycled for subsequent consumption as they are produced, and they are not present in the final waste.

Nuclear safety excellence

Like the previous generation, this 4th generation of nuclear systems is aimed at ensuring an optimal level of operating safety and reliability, with certain models featuring robustness characteristics making them easier to operate, particularly for countries that do not have infrastructures or operating capacities comparable to our own.

Cost saving

Cost saving is a key factor, both for developed countries with strong competition among energy sources and for developing countries requiring a stable and economic energy supply. The current generations of nuclear reactors have strong advantages in this respect, and the future generation should reinforce these advantages, namely by reducing investment costs and construction times. Certain 4th generation reactor models are modular, allowing for standardized construction and better investment progressivity.



© D.R.

Fig. 1. Sea water desalination plant.

Satisfying broader requirements (hydrogen production, desalination)

Like current systems, 4th generation systems will produce electricity. The demand is strongly increasing, since one third of the world's population is currently without electricity. They will also make it possible to produce drinking water very economically, by desalinating sea water using the residual heat from systems operating at very high temperatures (Fig. 1). This is also an important challenge, since there are currently 1 billion people without access to drinking water under satisfactory conditions.

They are also intended to produce hydrogen without CO₂ emission (unlike current technologies). Hydrogen is a future energy vector to supplement or substitute hydrocarbons, whose resources are clearly limited (Fig. 2).

Technological breakthroughs for 4th generation nuclear systems

What technologies need to be developed to ensure the maturity of 4th generation nuclear systems?

Launched by the US Department of Energy in 2000, the Generation IV International Forum comprises 11 partners

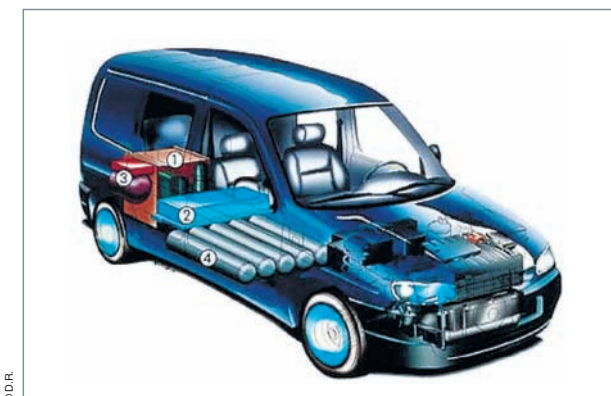

© D.R.

Fig. 2. Principle of a hydrogen-powered vehicle. Hydrogen can be used to power an internal combustion engine or a fuel cell.

(Argentina, Brazil, Canada, Euratom, France, Japan, South Korea, Switzerland, United Kingdom and United States) and is one of the main international frameworks for the development of future nuclear systems. It has selected six systems considered as most promising (Fig. 3), using the following types of coolants:

- Gas (high-temperature helium)
- Liquid metal (sodium or lead)
- Water (at very low density and in “supercritical” state – exceeding 22.0 MPa and 500 °C)
- Molten salt (with the fuel and coolant forming a single fluid so as to continuously reprocess the nuclear materials)

Very high temperature gas-cooled systems: A promising technology

The high-temperature gas-cooled reactor concept has significant advantages for achieving all the objectives described above. It benefits from the development of high-temperature reactors from 1970 to 1980 in the United States, France (in cooperation with General Atomics), Germany and the United Kingdom. Five reactors of this type have been built, accumulating a total of 60 years of operating feedback. 4th generation gas-cooled reactors will draw on the technological and industrial progress made since then, namely the development of high temperature gas turbines and high temperature-resistant materials. The United States, Japan and France (CEA, AREVA, EDF) are actively engaged in their development.

What are the technological breakthroughs required for the development of 4th generation gas-cooled reactors?

1) Achievement of higher temperatures (~1,000 °C)

A coolant temperature in the order of 1,000 °C would improve electrical production efficiency by up to 50%, *i.e.*, to produce 1 GW of electricity, only one 1 GW of heat would need to be released (as opposed to 2 GW with current water-cooled reactors). This increase in coolant temperature would also allow enable efficient hydrogen production. In order to achieve this, it is necessary to develop and qualify the materials, components (fuel, reactor vessel, heat exchangers, etc.) and general technology of high-temperature helium systems. In particular, it is necessary to implement technological test and qualification loops, including core material qualification loops in irradiation reactors. The Japanese have built a small high-temperature test reactor (HTTR) that achieved a temperature of 950 °C in April 2004.

2) Development of hydrogen production processes

Thermochemical processes can be used to decompose water molecules and produce hydrogen (and oxygen) at temperatures close to 900 °C. They are the subject of active and cooperative research in Japan, the United States and France. A small-scale test loop has been implemented in Japan, producing approximately 30 l/h of hydrogen. At present, the research teams have established the feasibility of a production efficiency

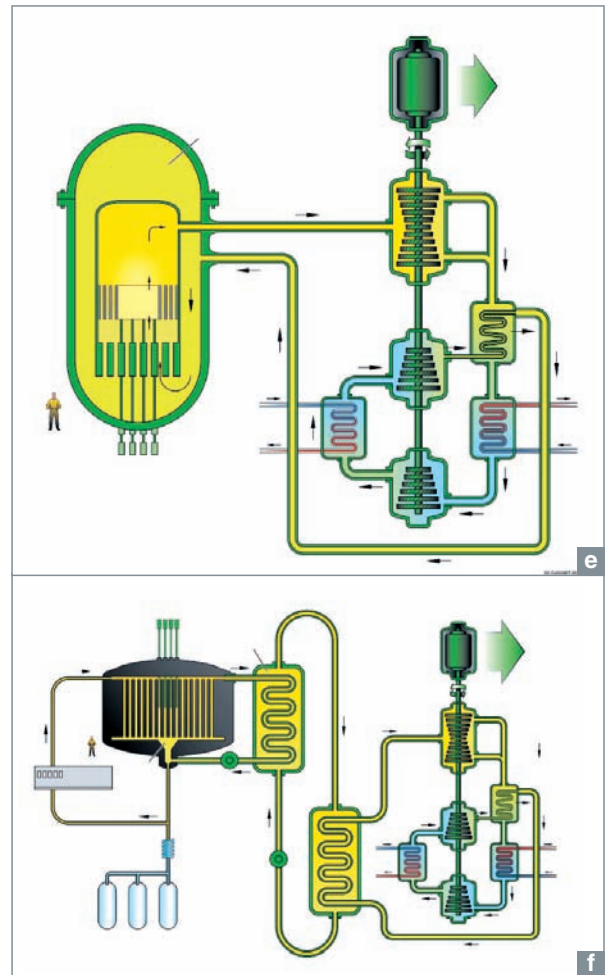
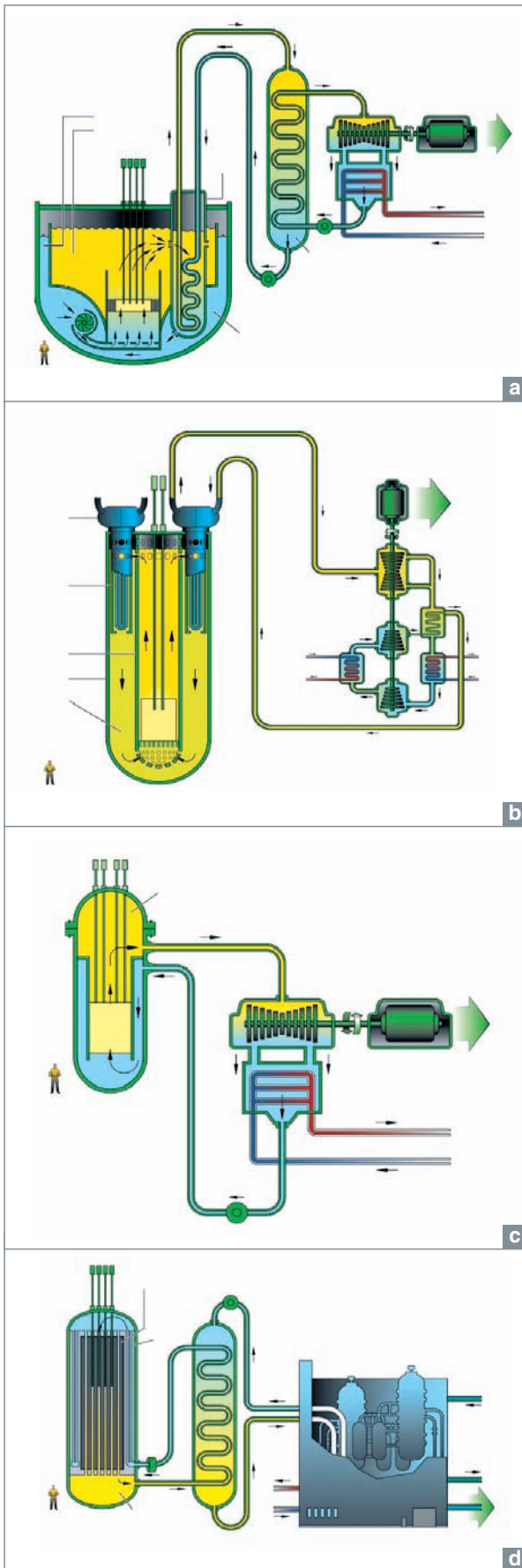

Fig. 3. Six systems selected by the Generation IV International Forum. Starting from the top left: a): SFR (sodium-cooled fast reactor); b): LFR (lead-cooled fast reactor); c): SCWR (supercritical water-cooled reactor); d): VHTR (very high temperature gas-cooled reactor); e): GFR (gas-cooled fast reactor); f): MSR (molten salt reactor). Two of the six systems chosen are gas-cooled.

of 35%. The objective is now to achieve a production efficiency of 50 to 55%.

Another possible method is to use high-temperature water vapor electrolysis, which also requires very high temperatures to obtain sufficient efficiency.

All such systems require the development of specific processes, materials, components and large-scale qualification test loops (1 MW and a hydrogen production of 100 m³/h).

Their design is based on the physical separation of the reactor and the hydrogen production unit. The United States plan for the construction of a 600 MWth prototype reactor producing both electricity and hydrogen towards 2015-2020.

3) Development of reactor fuel and fuel cycle technologies

Gas-cooled systems have numerous advantages, including the remarkable properties of helium (chemically neutral and transparent to neutrons). The gas-cooled reactors built up to now were thermal neutron reactors. In order to make better use of uranium resources and consume all recycled actinides, a sufficiently high neutron energy domain must be achieved with fast neutrons.

For this purpose, it is necessary to develop a fuel with an actinide density approximately three times higher than that of the fuel developed for high-temperature reactors.

It is also necessary to operate the reactor (and its fuel) at high power levels, and to test and qualify the safeguard systems used to cool the reactor, ensure fuel integrity and confine nuclear radioactivity in all situations, particularly under loss of pressure and helium circulation conditions.

Finally, it is necessary to develop reprocessing and refabrication methods for these new fuels, which have interesting properties (resistance to high temperatures, good heat conduction and good containment of radioactive elements) but for which no processing or recycling methods are yet available. Such promising methods have been identified and subjected to preliminary tests, with encouraging results:

- Destruction of ceramic cladding layers, to access the fuel for subsequent reprocessing;
- Extraction and recovery of all actinides, so as to recycle them and only consider fission products as final waste (packaged to ensure durable containment). The extraction molecules and processes benefit from the results of developments pursuant to the French law of December 30th 1991 on nuclear waste;
- Refabrication of a new fuel containing the actinides to be recycled.

This will require fabrication tests and implementations in shielded cells, behavior tests in irradiation reactors, and fuel reprocessing tests in hot laboratories such as the CEA's ATALANTE laboratory in Marcoule.

Sodium-cooled fast reactors: Application of achievements with a view to perfecting this technology

Even though they are more limited, in terms of temperature, than high-temperature reactors (which makes hydrogen production less accessible), liquid metal reactors are well suited for fast neutron conditions (Fig. 4).

France has strongly contributed to the development of sodium-cooled reactor technology and intends to apply its achievements to pursue future developments within the scope of international cooperation, namely with Japan, which has become the leader of this concept in the Generation IV International

Forum. The main required technological breakthroughs are:

- Improvement of in-service inspections;
- Cost saving;
- Replacement of water in sodium-water heat exchangers with a gas that does not react with sodium in case of leakage.

Active technological watch on other reactor concepts

A technological watch is maintained for other concepts so as to fully profit from collaborations and not disperse efforts.

In 2002, the Generation IV International Forum selected a lead-alloy-cooled reactor concept within the scope of a collaboration (planned at the time) with Russia, the only country to have sufficiently developed this technology (for nuclear submarine propulsion) and developed a basis to consider its application in 4th generation commercial reactors. To date, Russia's participation in the Generation IV International Forum has been delayed.

Technological breakthroughs for the supercritical water-cooled reactor concept, upheld by Canada, mainly concern the control of thermal exchange conditions and flow instability risks, corrosion, safety (namely core cooling and sub-criticality control under accident conditions), and the development of fast neutron cores allowing recycling and fission of all actinides.

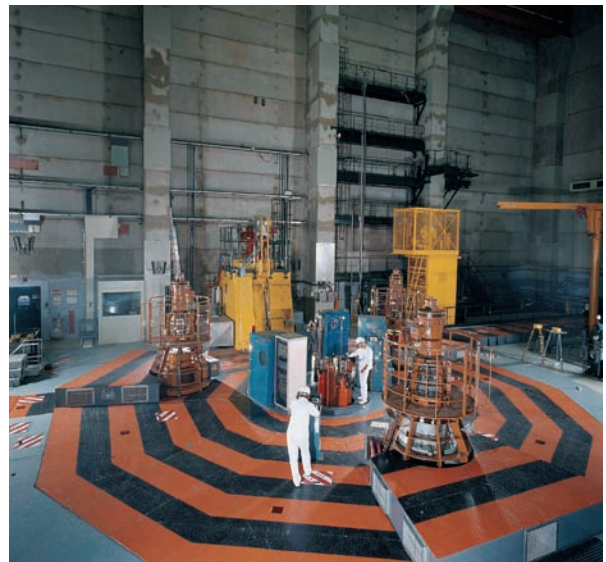

Fig. 4. Reactor hall in the Phénix plant. Located on the Rhone riverbank, the Phénix plant is an integral component of the Marcoule nuclear site (Gard province) and a prototype of the sodium-cooled fast neutron reactor series (RNR-Na). The experimental program mainly concerns the transmutation of actinides, but the experience acquired also benefits research on future nuclear systems.

The molten salt reactor concept is considered as an option for a more distant future and has less support at present. Nevertheless, there are plans to conduct basic research, particularly on continuous reprocessing methods for fuel-containing salts, corrosion control, and safety.

Research on thermonuclear fusion

Energy production through thermonuclear fusion is another possible option for the future. Research on this technology is largely internationalized, namely through the ITER experimental reactor project, and aimed at demonstrating its scientific and technical feasibility towards 2020. A working demonstration at a significant scale (*i.e.*, a first reactor producing electricity) could then be pursued simultaneously with the deployment of the fission systems described herein, possibly followed by an industrial implementation to supplement other energy sources available at that time.

Prospects

Given the energetic and environmental challenges facing our planet in the 21st century (doubling of energy requirements and increase in population by 3 billion before 2050 – see Figure 5, increase fossil fuel costs and depletion of resources, fight against global warming), we are going to require important and sustainable energy sources without greenhouse gas emissions. Nuclear energy can provide a significant contribution to meet these requirements, with long-term resource availability and the possibility to minimise radioactive waste.

Current reactors have demonstrated the maturity of the nuclear industry. The most recent and industrially available 3rd generation systems (*e.g.*, EPR) benefit from this maturity and produce further improvements (operation, safety, cost saving). The 4th generation systems address new objectives: sustainable development (waste minimisation, optimal use of resources) and new applications (hydrogen for transport). They are currently being developed. Test reactors have been built, technological breakthroughs have been clearly identified and promising options to achieve them are indeed available, but

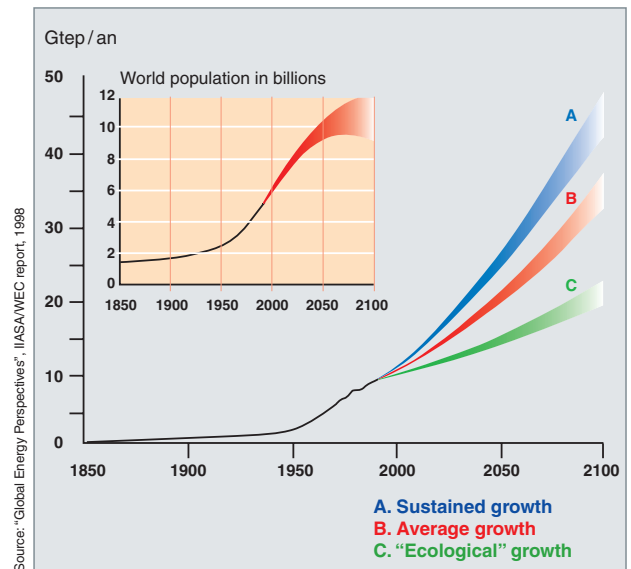

Fig. 5. Estimate of world energy requirements.

significant developments are still needed in order for 4th generation systems to attain the technical maturity allowing for industrial deployment. New materials, processes, components and systems need to be developed and qualified (test loops), and demonstration reactors need to be built, followed by prototypes and the subsequent exploitation of operating feedback. This will take the amount of time typically needed to develop a new generation of nuclear systems, *i.e.*, approximately 20 years. The first prototypes will probably be built towards 2020, but the effective deployment of 4th generation systems will probably take place towards 2030-2040.

It must be stressed that, for the first time since the beginning of nuclear energy, these next-generation systems are being developed within an international framework, making it possible to gather and coordinate the scientific and technical expertise of the various partners and thereby distribute development efforts over a significant period of time.

Pascal ANZIEU,
Nuclear Development and Innovation Directorate

Generation IV: Methodology and selection criteria for nuclear energy systems for the future

Much energy has been vested in international cooperation to define goals for the nuclear energy systems of the future, and also select the key technologies for achieving them. The effort has been made primarily through the Generation IV International Forum (GIF) that the American Department of Energy launched during the course of 2000.

The GIF is a major initiative in the effort to revitalize nuclear energy. The technological orientation phase, enshrined in the Technology Roadmap (<http://gif.inel.gov/roadmap/>), is the starting point in the process to identify and organise the R&D required to develop a new generation of nuclear energy producer systems due to go on stream around 2030-2040. Each

4 Goal Areas	8 Goals	17 Criteria	26 Metrics
Sustainability	SU1 Resource Utilization	SU1-1 Fuel Utilization	• Use of fuel resource
	SU2 Waste minimisation and management	SU2-1 Waste minimisation	• Waste mass • Volume • Heat load • Radiotoxicity
		SU2-2 Environmental impact of waste management and disposal	• Environmental impact
Economics	EC1 Life Cycle Cost	EC1-1 Overnight construction cost	• Overnight construction cost
		EC1-2 Production cost	• Production cost
		EC1-3 Construction duration	• Construction duration
	EC2 Risk to Capital	EC2-1 Overnight construction cost	• Overnight construction cost
		EC2-2 Construction duration	• Construction duration
Safety and Reliability	SR1 Operational Safety and Reliability	SR1-1 Reliability	• Forced outage rate
		SR1-2 Worker/public – routine exposure	• Routine exposure
		SR1-3 Worker/public – accident exposure	• Accident exposures
	SR2 Core Damage	SR2-1 Robust safety features	• Reliable reactivity control • Reliable decay heat removal
		SR2-2 Well-characterized models	• Dominant phenomena – low uncertainty • Long fuel thermal response time • Integral experiments scalability
	SR3 Offsite Emergency Response	SR3-1 Well-characterized source term / energy	• Source term • Mechanisms for energy release
SR3-2 Robust mitigation features		• Long system time constants • Long and effective oldup	
Proliferation Resistance and Physical Protection	PR1 Proliferation Resistance and Physical Protection	PR1-1 Susceptibility to diversion or undeclared production	• Separated material • Spent fuel characteristics
		PR1-2 Vulnerability of installations	• Passive safety features

Fig. 6. Separating out the goal areas into criteria and metrics for evaluating Gen. IV systems.

of the systems comprises a nuclear reactor, an energy conversion system and the necessary fuel cycle, fuel manufacturing, spent fuel and final waste management equipment.

The goal areas adopted for the fourth generation systems were originally put forward by a Nuclear Energy Research Advisory Committee sub-committee that advises the American Government on nuclear energy issues. GIF members subsequently discussed, developed and ratified these areas. There are four major goal areas: aptitude for developing sustainable energy, economic competitiveness, more robust safety and reliability and nuclear materials proliferation resistance along with physical protection for installations.

Evaluation and selection method

A standard evaluation methodology is essential if objectivity and consistency are to be guaranteed across the evaluations of the potential offered by the systems initially proposed. It has been applied to selecting the nuclear energy systems planned for international development through GIF collaboration ventures.

The four major goal areas presented above have been separated out into fifteen criteria and twenty-four performance indicators or metrics (cf. Figure 1). While these metrics characterize the systems according to set criteria acknowledged as being important, they do not claim to offer a comprehensive evaluation.

Twenty families of nuclear systems were initially presented by nuclear engineers and scientists. A one hundred-strong international expert panel evaluated the performances of each family against the twenty-four metrics, producing a theoretical distribution representing an estimate of the performance level and uncertainties surrounding it, bearing in mind that most of the system definitions were still in their infancy. Final selection of the systems also brought into play other considerations such as the selection's completeness in terms of diversity of tech-

nologies, deployment lead times, the possibility of staged development and the ability to meet the identified needs of electricity production, hydrogen production, fissile material regeneration and transmutation of long-lived waste for forthcoming decades. Figure 7 summarizes the timetable envisaged for these various applications.

A final selection criterion was the degree of technological innovation in the candidate systems – which really gives good grounds for wide-reaching international cooperation – and the possible spin-offs for the other nuclear systems, or for the current or next generation of reactors.

Figure 8 summarizes the most significant performance evaluations of the initial set of system families.

The following six systems deemed the most promising at the end of this evaluation exercise were called on to rally Forum cooperation on development work starting from 2004:

- VHTR - Very High-Temperature Reactor system, over 1,000 °C, helium-cooled, dedicated to hydrogen production or hydrogen/electricity cogeneration;
- GFR - Gas-cooled Fast Reactor system – Helium-cooled fast reactor;
- SFR - Sodium-cooled Fast Reactor system;
- SCWR - SuperCritical Water-cooled Reactor system;
- LFR - Lead-cooled Fast Reactor system – Lead or Pb-Bi alloy-cooled Fast reactor;
- MSR - Molten Salt Reactor.

As Figure 8 shows, the gas-cooled nuclear systems scored well against the selection criteria. Two of the six selected systems are gas-cooled.

VHTR offers the strengths of economics and safety in particular. Because an open cycle is used, its aptitude for sustainability is deemed to be similar to that of a 2nd generation reactor. Likewise, the radiotoxicity and volume of VHTR waste are characteristically high.

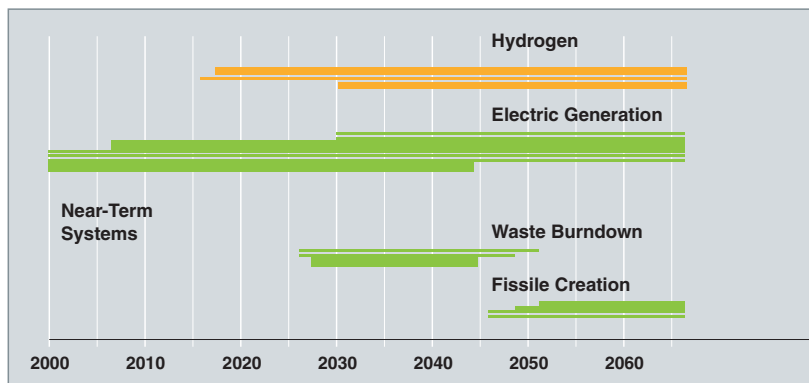

Fig. 7. Timetable envisaged for the various applications.

During the 2000 discussions, the French Generation IV Forum representatives expressed their interest in the Very High Temperature advanced gas-cooled (VHTR) and fast neutron with full actinide recycling reactor (GFR) systems, while committing to assisting in the sodium-cooled fast neutron reactor (SFR) system. The international cooperation development plans of these three systems, which are also strongly supported by the United States and Japan, are the most advanced.

Identifiers of the evaluated nuclear systems

Water-cooled reactors

- W1 – IPSR, Integral Primary System Reactor
- W2 – SBWR, Simplified Boiling Water Reactor
- W3 – Advanced CANDU 700 Reactor System
- W4 – SCWR, Supercritical Water Reactor, Thermal Spectrum
- W5 – SCWR, Supercritical Water Reactor, Fast Spectrum
- W6 – HC-BWR, High-Conversion Boiling Water Reactor

Gas-cooled reactors

- G1 – PBR, Pebble Bed Modular Reactor
- G2 – PMR, Prismatic Modular Reactor
- G3 – VHTR, Very High Temperature Reactor, Open Cycle
- G4 – HTGR, Generic High Temperature Reactor, Closed Cycle
- G5 – GFR, Gas Fast Reactor

Liquid metal fast breeder reactors

- L1 – Sodium-Cooled, Oxide fuelled, Aqueous Reprocess Reactor
- L2 – Sodium-Cooled, Metal alloy fuelled, Pyroprocess Reactor
- L4 – Small α Pb/Bi Reactor
- L5 – Large α Pb/Bi Reactor
- L6 – Pb/Bi “battery” Reactor

Unconventional reactors

- N1 – MSR, Molten-Salt Reactor
- N2 – VCR, Vapour Core Reactor
- N3 – AHTR, Advanced High Temperature molten salt-cooled Reactor

Fig. 8. Performance assessments of Generation IV systems applying the criteria of aptitude for sustainability, safety and risk and economics. The scores awarded to the various systems range from 0 to 1, the highest score corresponding to the most satisfactory system against the criterion under consideration.

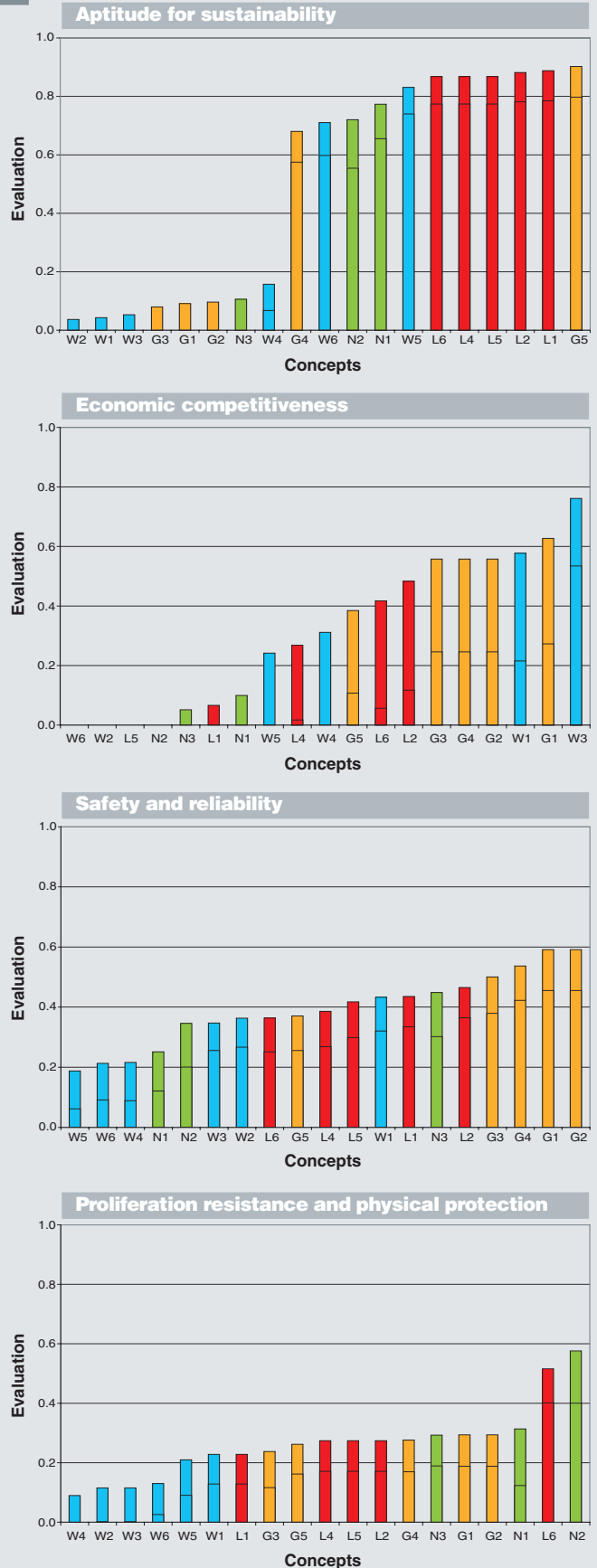

GFR offers a different picture: its closed fuel cycle makes both waste and its aptitude for sustainability positive strengths. On the other hand it meets the economics and safety criteria somewhat less satisfactorily, without for that matter constituting problem areas.

They are followed by the Supercritical Water (SCWR) system, on behalf of which French efforts are concentrated on research into the essential systems for its feasibility, safety and performance levels. The molten salt reactor (MSR) comes last in line. France will also be involved in the MSR while the Forum's activity amounts to sharing major results for the system's feasibility rather than actual development,

The activities of the European Commission's 6th Framework Research and Technological programme, relating to new nuclear energy systems (new and innovative concepts) is organized along the same lines, particularly as regards gas-cooled systems.

The Generation IV forum has scored a major point: it is the first time that specialists from across the world have agreed on the development goals for the nuclear systems of the future, and on the principle of evaluating the various conceivable systems to achieve these goals. Up to now, the relevant criteria had never been clarified or published, and many of them were purely national. However, the criteria retained by the GIF broadly transcend national interests and have been inspired on purely civilian grounds. This approach should represent major progress for nuclear energy's credibility as viewed by the public and for its peaceful development.

Gian-Luigi FIORINI,
Nuclear Development and Innovation Directorate

Research on an international scale

French stakeholders from the nuclear industry are keenly involved in many areas of the Generation IV International Forum (GIF). Their prime concern is to lend their support to nuclear energy's ambitious innovatory goals, such as resource-saving and minimising waste, so that they are adopted in sustainable energy development programmes on a world scale. Furthermore, this commitment should redouble French research and development efforts for these innovations by sharing the effort and the co-funding opportunities for major research facilities and prototype reactors in France and Europe.

The level of commitment varies in line with the system involved. In the SFR field, France and the European Community seek to validate the expertise they have acquired on sodium-cooled fast reactors. As for GFR, they favour cooperating with European, American and Japanese partners to remove the outstanding technological obstacles and make an international project of the Research and Technological Development Reactor demonstrator. Experience acquired through research into radioactive waste management and developing processes capable of full Generation IV System fuel recycling with sufficient proliferation risk resistance, will

find its logical outlet. Moreover, despite their limited resources, French researchers will be able to take part in developing key technologies for a number of systems, and thus postpone having to choose a fast neutron system for the second French nuclear power plant base renewal phase until 2015. Lastly, cooperation is useful for continuing evaluation of more forward-looking systems such as Supercritical Water-cooled Reactors (SCWR) and Molten Salt Reactors (MSR) through the Forum's extended panel of experts.

In Europe, the European Commission's publication of the report "Towards a European Strategy of Energy Security" in November 2000 and the entry of the Euratom signatory member countries as the eleventh member of the GIF have resulted in organizing the part of the Framework Programme for Research and Technological Development (FPRTD) dedicated to nuclear energy systems for the future into projects that mirror the Forum's projects, thus enhancing exchanges between the two programmes (Cf. Table 1). Recommendations are being drawn up for the 7th FPRTD proposing setting up a fully-dedicated research section into nuclear energy systems for the future.

Equivalence between the organization of the European projects and the Generation IV International Forum Project			
5 th European FPRTD	6 th European FPRTD	Generation IV International Forum	7 th European FPRTD
HTR – Technology Network	V/HTR-IP (integrated project)	Very High-Temperature Reactor (VHTR)	V/HTR-IP (integrated project)
Gas-Cooled Fast Reactor (GCFR)	Gas-Cooled Fast Reactor (Strep ¹)	Gas-Cooled Fast Reactor (GCFR)	Gas-Cooled Fast Reactor (Strep or IP)
High Performance LWR (HPLWR)	HPLWR-II (Strep ¹)	Supercritical Water-Cooled Reactor (SCWR)	Supercritical Water-Cooled Reactor (Strep)
Molten Salt Technology review (MOST)	LICORN Scientific Feasibility of Molten Salt Reactors (MSR) for Energy Production and Waste Minimisation (Strep ¹ proposed in 2006)	Molten Salt Reactor (MSR)	Molten Salt Reactor (Strep)
–	ITSR Innovative Technology for the Sodium-Cooled Reactors (Strep ¹ proposed in 2006)	Sodium-Cooled Fast Reactor (SFR)	To be defined
–	ELSY European Lead-Cooled System (Strep ¹)	Lead-Cooled Fast Reactor (LFR)	To be defined

1. Strep: "Specific Targeted Research Project".

The international organizations have also opted to contribute to preparations for the nuclear energy systems of the future. In 2001 the IAEA launched its International Project on Innovative Nuclear Reactors and Fuel Cycles (INPRO) initiative that involves many non-GIF countries, such as Russia. This initiative subscribes to the major GIF-declared goals for nuclear energy systems for the future: economics, sustainability and environmentally-friendliness, safety, waste management and proliferation resistance. The IAEA is represented at GIF. The OECD conducts prospective studies in this field through its international energy agency, the IEA and nuclear energy agency, the NEA.

The CEA's Nuclear Energy Division is involved in all these initiatives in addition to the many bilateral working arrangements to which it is committed, primarily with various European countries, Russia and China as well as GIF members. Discussions on nuclear systems safety have recently opened up with India.

► References

"Innovative Nuclear Reactor Development – Opportunities for International Cooperation", IAEA document – OECD, 2002.

PERERA (J.), *"Fuelling Innovation"*, in *Nuclear Engineering International*, January 2004, P. 24-29.

Towards a European Strategy of Energy Security (Nov. 2000) – COM(2000) 769 – European Commission.

Pascal ANZIEU,
Nuclear Development and Innovation Directorate

Participation of the CEA's Nuclear Energy Division

Among the systems selected by the Generation IV International Forum, the CEA gives priority to fast neutron systems with a closed fuel cycle to support sustainable energy development and key technologies for nuclear hydrogen production. It conducts research on fast neutron systems (Generation IV sodium-cooled and gas-cooled reactors) based on a twofold approach: innovation research on the technological difficulties of sodium-cooled systems, and in-depth R&D on the specific technological obstacles to the development of gas-cooled fast neutron systems (namely the fuel). It also conducts research on new methods to process spent fuels and recycle all major and minor actinides, uranium and plutonium. In addition, the CEA contributes to specific developments for very-high-temperature thermal neutron reactors (Generation IV VHTR) in collaboration with its industrial partners.

These choices correspond to the strategy adopted by the CEA in 2000 for its research on future nuclear systems, *i.e.*, maintaining an optimal level of expertise on sodium-cooled fast neutron reactors through R&D on the residual difficulties specific to these systems, and developing an evolutionary range of gas-cooled systems together with processes for full fuel recycling which are proliferation-resistant.

Lesser priority is given to the development of other systems, since certain doubts remain as to their feasibility or performance. They include the uncertainties of using supercritical water cooling for fast neutron systems which, *de facto*, constrains the research challenges to increasing the energy conversion efficiency of thermal neutron systems; they also include the very long-term delay in the development of molten salt systems (due to the technological obstacles to be overcome and the difficult transition from the fuel cycle of current water-cooled reactors towards the uranium/thorium cycle) and they finally handicap significantly the use of lead as a coolant for reactors in the one gigawatt range (due to reasons of weight, corrosion, and in-service maintenance and inspection conditions).

The development strategy for gas-cooled systems (VHTRs and GFRs) is based on the fact that they involve a common and complementary line of research. It is therefore necessary to make the most of research results on VHTRs as a resource for GFRs, *i.e.*, development of high temperature-resistant materials, development of helium circuit technologies, and choice of energy conversion systems, hydrogen production systems and computation tools.

The pursuit of R&D on themes common to VHTRs and GFRs makes it possible to limit research on fast neutron reactors to a few main aspects, such as the development of an innovative fuel and associated processing and refabrication methods, and the design of the reactor itself (taking into account its very different characteristics, mostly as regards safety). GFRs therefore offer a long term perspective for VHTRs, associating high temperatures and fast neutrons with fuel recycling.

The next-generation gas-cooled reactors are not entirely new systems. Reactors of this type have been built and operated in the past. The first generation (medium-temperature systems) was tested in several countries after World War II. At the time, CO₂ was used due to its transparency to neutrons and low chemical activity. These reactors were used to produce plutonium while supplying electricity. Industrial models were developed in France (graphite-moderated gas-cooled natural uranium systems) and the United Kingdom (Magnox and AGR systems), and more efficient versions were developed in the 1970's, in the United States and Germany in particular (to compete with the growing industrial development of PWRs). The development of high-temperature reactors therefore resulted from the use of helium (allowing high temperatures and efficient electrical production) and the development of high temperature-resistant microparticle fuels. The construction and operation of several prototypes enabled the development and validation of most of the associated technology. These achievements constitute the basis for the new research program. The constant progress in the field of metallurgy, the development of very-high-temperature gas turbines for the aeronautics industry and the desire to surpass the intrinsic limitations of conventional water-cooled reactors have led to the formulation of ambitious objectives such as described above.

Pascal ANZIEU,
Nuclear Development and Innovation Directorate

The first gas-cooled graphite-moderated reactors: History and performance

At the end of the second world war, those countries that decided to develop a nuclear generating capability were faced with a wide choice of possible reactor technologies. The possible options arise from a combination of three elements: **coolant***, **moderator*** and fuel.

While France had access to sufficient quantities of uranium ore, the country had no **heavy water*** or **enrichment*** facilities, and this severely limited the choices available. Graphite has many advantages as a moderator as it absorbs few neutrons enabling the use of natural, unenriched uranium as a fuel. The graphite industry was also a mature one as the material had been used for a long time in the electro-chemical and electro-metallurgical industries. Carbon dioxide was chosen as the coolant. This gas offers a number of advantages. It is readily available, cheap, and well known in industry. It has good heat transfer characteristics (for a gas) and good neutronic properties. It is also chemically compatible with the use of graphite as the moderator and with the cladding material and fuel used, provided that certain precautions are observed.

In France, the decision was rapidly taken to build reactors using a graphite moderator, a carbon dioxide coolant and natural uranium fuel.

Great Britain had made the same choices a short while before and was ready to develop this technology more extensively than in France with the original MAGNOX design followed by the Advanced Gas-cooled Reactor (AGR).



Fig. 9. The NUGG plant in Chinon.

Natural Uranium Graphite Gas (NUGG) reactors and the British MAGNOX variant

While it is certainly possible to use natural uranium in a graphite moderated reactor, the fuel must be in its metallic state in order to achieve a high enough density of fissile material. It must also be renewed at regular intervals to minimise the number of **sterile*** neutron **captures*** by the fission products. The MAGNOX and NUGG reactors used bars of uranium clad in a magnesium alloy. These were inserted into channels in a massive graphite pile through which carbon dioxide was circulated under pressure. These reactors were built using fairly primitive technology – that available in France immediately after the war – but the poor slowing-down power of graphite meant that the size of the plants had to be large in order to achieve significant power levels, and this in turn led to a high capital cost. Their sensitivity to the **xenon effect*** made them very inflexible in operation, but the ability to unload the fuel without having to shut down the reactor made it possible to produce almost pure Pu 239 for military applications.

Nine NUGG reactors were built in France. The first three reactors, at Marcoule, were used almost exclusively for the manufacture of plutonium. The electrical power generation program began with the successive commissioning of Chinon 1 (1957), Chinon 2 (1958), and Chinon 3 (1961), with power capabilities of 70, 200 and 480 MWe net respectively (Fig. 9). There was no question of waiting for these reactors to go critical, even less of waiting for the first operational results, before starting work on the next design. These three reactors were prototypes, and each very different from the others. The next reactors were built at Saint Laurent des Eaux (1963 and 1966) and Bugey (1965). The Fifth Plan (1966-1970) included projections to build a total capacity of 2,500 MWe of NUGG reactors. The construction of a new unit at Fessenheim began in 1967 but was abandoned at the end of 1968. By that time, water-cooled reactors had become the favored option.

The characteristics of NUGG reactors are listed below, using Saint Laurent 2² as an example.

2. See table, p. 23.

The low specific power of the reactor meant that the core had to be very large. This core was enclosed in a vessel that also contained the coolant circuit and its heat exchanger. The vessel was a pre-stressed concrete structure, 33 meters in diameter and 48 meters high. The internal face of the vessel was lined with steel 25 mm thick in order to prevent any leakage of the CO₂ under a pressure of 29 bar.

The graphite pile in the reactor was in the form of a vertical cylinder 10.2 meters high and 15.7 meters in diameter. It consisted of a network of columns locked together by mortise and tenon joints. The pile weighed no less than 2,680 tonnes.

The four CO₂ – steam **heat exchangers*** were single tube cross circulation types. The water inlet was in the lower section, while the hot CO₂ entered the upper section. The total CO₂ flow rate was 8.6 t/s, and the steam flow rate was 0.6 t/s.

The fuel elements were replaced while the reactor was in operation at a rate of around 2 to 3 channels per day, requiring the use of a sophisticated handling system.

A system for detecting the presence of fission gasses in the coolant was used to detect and locate any cladding failure.

The fuel elements used in the NUGG reactors were developed over time. In the latest versions, each element consisted of a tube of fuel material (an alloy of uranium with 0.07 % aluminum and 0.03 % iron) surrounding a graphite core. The borderline neutron balance of the NUGG reactors resulted in a fairly low fuel **burn-up rate*** of 6.5 GWj/t. The maximum operating temperature of the reactor was determined by the maximum permissible temperature of the uranium. This was set at 650 °C at the internal surface of the tube.

Safety of NUGG and MAGNOX reactors

The containment of the fission products is provided by two **barriers***; the fuel element **cladding*** and the pre-stressed concrete vessel.

As the cladding is exposed to conditions close to its technological limits during operation, specific precautions must be taken in order to ensure that it remains within these limits. The core cooling is an essential factor in maintaining the integrity of the cladding. Four independent cooling systems are used.

The monitoring of the cladding integrity is also a crucial factor in maintaining the safety of NUGG and MAGNOX reactors. The monitoring system works by preventing the operation of the reactor if any of the claddings are damaged. This is to avoid the oxidation of the metallic uranium by the CO₂ and to keep the coolant gas as clean as possible.

In the event of a failure of the first barrier, the vessel is purged through filters trapping aerosols and radioactive iodides.

The reference accident for these reactors is a loss of pressure in the vessel via a fuel loading well or following a break in a gas pipe. A backup cooling system maintains the integrity of the barriers in the event of a total loss of the normal cooling systems. Studies of the radiological consequences of an accident do not indicate any major environmental risks. The addition of an additional containment vessel was not considered necessary.

The only notable incidents occurring in this type of reactor were the meltdown of five fuel elements at Saint Laurent 1 and four fuel elements at Saint Laurent 2. Both had only minor consequences for the operating personnel, and the environmental impact was negligible.

Releases and waste

The main component of the solid waste produced by these reactors are the graphite sleeves from the fuel elements. The annual volume produced by a 500 MWe NUGG or MAGNOX reactor is around 25 m³, equivalent to a mass of 45 tonnes³.

Experience feedback

The main problem with this type of reactor was the corrosion of structural components by oxidizing radicals produced by **radiolysis*** of the carbon dioxide gas. The power levels of MAGNOX and NUGG reactors had to be reduced slightly in order to minimise this effect. For the same reason, the gas outlet temperature has been limited to a maximum of 400 °C.

Other problems associated with these old graphite-moderated gas-cooled reactors include friction wear, noise and vibration.

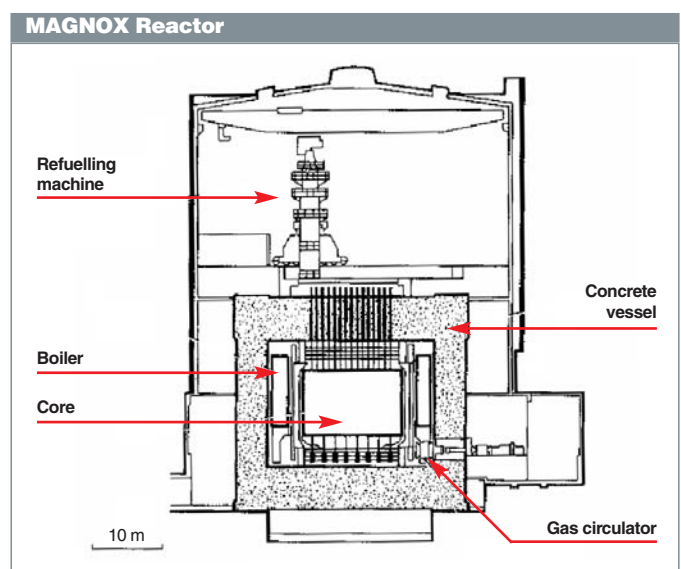

Fig. 10. MAGNOX Reactor.

3. For more details, see Section pages 27-32 dealing with graphite waste.

The Advanced Gas-cooled Reactor (AGR)

Great Britain has developed the concept of the gas-cooled reactor further than any other country with the MAGNOX (Fig. 10) and AGR designs (Fig. 11). The AGR is a direct descendent of the MAGNOX reactor and has only been built in Great Britain. When enriched uranium became commercially available in the early 1970s, it was used in gas-cooled reactors relieving some of the constraints on the reactor neutron economy. AGRs use a fuel consisting of lightly enriched uranium oxide, with reloading carried out while the reactor is in operation. The power density is four times that of a MAGNOX reactor, and the volume of the heat exchangers is smaller. The chemical compatibility of UO_2 and CO_2 and refractory nature of the oxide make operation at higher temperatures possible. The coolant is at $650\text{ }^\circ\text{C}$ on leaving the core, giving the AGR an excellent electrical efficiency (42 %). The first reactors suffered from a number of problems, partly due to failures in industrial organization, and partly due to a failure to control corrosion. Methane was added to the coolant gas in order to reduce radiolytic corrosion by CO and the oxidizing free radicals formed by the irradiation of the CO_2 . Controlling the concentration of this gas proved to be difficult. Fourteen AGRs were built in Great Britain in the early 1970s. They are still operating well at the present time, but the design has not been adopted in any other country.

Graphite-moderated gas-cooled reactor technology has gradually been abandoned in France, Italy, Spain and Japan, and only accounts for 4 % of worldwide nuclear capacity. The British AGR and MAGNOX reactors are the only types still in operation. The shut-down of the MAGNOX reactors began in 2002.

This first generation of gas-cooled reactors has an excellent operating record, generating electrical power continuously with no major accidents. However, these old NUGG, MAGNOX and AGR designs are now obsolete for economic reasons. The gas-cooled reactor concept still has a future, however, as a result of important advances in the fields of materials and fuel. It is now possible to operate at much higher temperatures than in the past, and this makes these systems much more attractive. Will it be possible for gas-cooled reactors to displace water reactors and take a leading position among the current third generation or future fourth generation systems? It is still too early to say. The remainder of this monograph summarizes recent advances in this field.

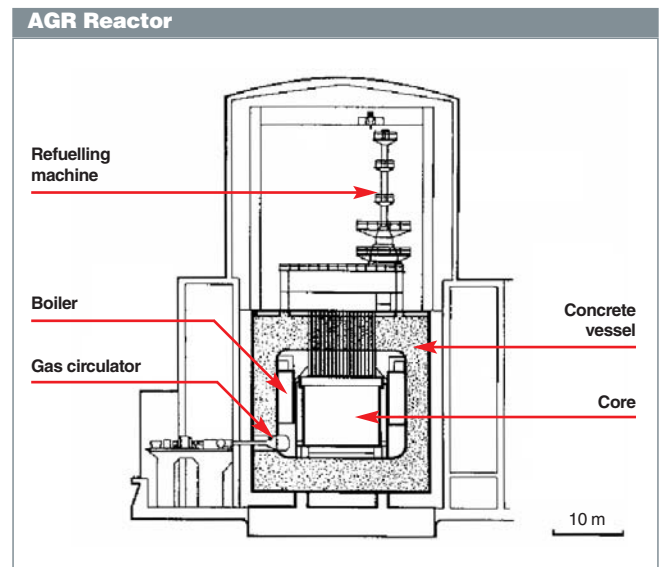

Fig. 11. Cross-section of an AGR.

Comparison of the characteristics of an AGR (Hinkley Point B), a MAGNOX reactor (Wylfa) and a NUGG reactor (Saint Laurent 2)				
	Units	AGR	MAGNOX	UNGG
Mass of U	t	114	395	430
Fuel		UO_2 Oxide Steel cladding	U metal Mg alloy cladding	U metal Mg alloy cladding
Power density	MW/m ³	3	~1	1
Enrichment	%	2.1 à 2.6 %	U natural (0.7 %)	U natural (0.7%)
Cladding		Stainless steel	Mg alloy	Mg-Zr alloy
Coolant gas pressure	bar	41.9	27.6	29
Number of heat exchangers		12	4	4
Gas outlet temperature	°C	645	414	400
Maximum cladding temperature	°C	825	450	473
Mass of graphite pile	t	1,248	3,735	2,440
Net electrical power	MWe	625	590	480
Net efficiency	%	41.7	31.4	28.7
CO ₂ flow rate	t/s	3.8	10.2	8.6
Burn-up rate	GWj/t	18	4	6.5

Advantages and disadvantages of gas coolants for nuclear reactors.

The table below compares the main characteristics of gas, water and sodium coolants.

	Water	Sodium	Gas
Operating temperature of the coolant, directly affecting the efficiency of the energy conversion system.	★ Temperature limitations due to boiling and corrosion.	★★	★★★
Heat transfer performance merit figure: Thermal capacity and conductivity	★★	★★★	★ Solid-gas heat transfer is mediocre, imposing high coolant flowrates and pressures and limiting the core power density. Coolant circulation is expensive in terms blower power consumption.
Neutronic aspects, transparency to neutrons	★ Light water absorbs neutrons. Liquid water has a high moderating capacity, limiting its use to thermal spectrum reactors.	★★ Low neutron absorption. Very low moderating capacity, compatible with fast spectrum reactors.	★★★ Very low neutron capture. Zero moderating capacity, compatible with thermal or fast spectrum reactors.
Corrosion	★ High-temperature water is corrosive.	★★ Very low corrosive effect on reactor structures.	Gases can be easily purified. Chemical properties and corrosion behavior depend on the gas considered (see next table).
Technology: Seals, leaktightness	★★	★★ Sodium-cooled reactors operate at atmospheric pressure.	★ Leaktightness problems.
Technology: Core inspectability	★★★	★ Sodium is not transparent. Periodic surface inspections in opaque mediums are difficult.	★★★ Gas transparency facilitates in-reactor maintenance and interventions.
Safety	★★ Risk of vaporization, with large modification of neutronic and heat transfer characteristics of water.	Very little risk of vaporization, but burns with air and reacts violently to water.	★★ No change in chemical phase and reactivity, but high pressure drops result in a loss of cooling capacity.

The two gases considered for gas-cooled reactors are helium and CO₂. The table below compares their respective advantages.

	CO ₂	He
Thermodynamic properties	Good heat capacity (for a gas). Good energy conversion capacity (low Cp/Cv ratio).	Good thermal conductivity (for a gas).
Chemical stability, corrosion	CO ₂ has a high chemical reactivity above 650 °C (carburization of metals and graphite oxidation above this temperature). This reactivity increases further under exposure to radiation (due to the radiolytic decomposition of CO ₂ , which produces oxidizing and corrosive agents in response to gamma flux).	Chemically inert, regardless of temperature. No usage limitation under high temperatures.
Availability, resources	Abundant and very inexpensive.	Available and inexpensive (see below).

Helium is formed in the Earth's crust by radioactive disintegration of uranium and thorium alpha emitters. It is a sub-product of the natural gas industry, with certain deposits containing up to 7% helium. The world's reserves are estimated at 30 billion m³ NTP⁴, with main reserves located in the USA (13 Gm³), Russia (9), Algeria (2.1), Canada (2.1) China (1.1), Poland (0.8) and Holland (0.7). The world's annual consumption of Helium is close to 100 million m³ NTP, with a cost of approximately 2 €/m³ NTP⁴ (2005 price). The main current uses of Helium are cryogenics,

inert gas welding, leak detection, vessel pressurization, and controlled atmospheres (eg, for deep diving). Given the Helium inventory in a gas-cooled reactor, and its renewal rate (approximately 14,000 m³ NTP per installed gigawatt, with an annual loss rate of less than 10%), the coolant will represent a negligible fraction of the installation cost, and 5% of current resources would be sufficient to supply a world fleet of gas-cooled reactors with twice the capacity of the current fleet.

Bertrand BARRÉ (AREVA)

& Bernard BONIN (CEA),

Nuclear Energy Division, Scientific Directorate

4. NTP: in normal temperature and pressure conditions.

Graphite: a fascinating material

Thermal spectrum reactors require the use of a neutron moderator. The characteristics of graphite make this material particularly suitable for this application. It is together a moderator, a poor absorber of neutrons, it is refractory and resistant to corrosion, cheap, and well understood in industry as it is used in many other applications. Graphite has been used since the early days of the nuclear industry and it remains the material of choice for future gas-cooled reactors. Its importance as a nuclear material means that it continues to be the object of research. Its use and behavior in a reactor makes it unique among materials.

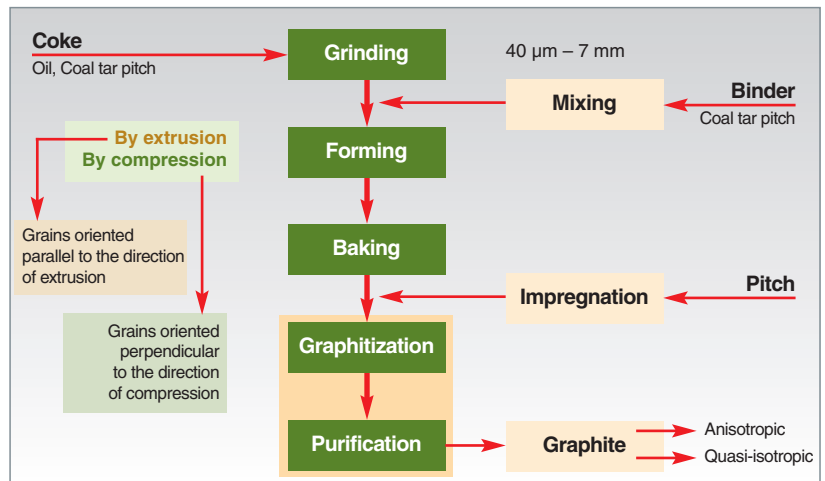

Fig. 12. Manufacture of graphite.

The various forms of graphite used in gas-cooled reactors

Carbon exists in a variety of forms, including vitreous carbon, coke, anthracite, pyrocarbon, carbon black, carbon nanotubes, and fullerenes. However, there are only two **allotropic*** forms; diamond and graphite.

Provided it is sufficiently pure, graphite is a good moderator of neutrons as it slows them down without absorbing them. The capture **cross section*** of C 12 is small, while the elastic diffusion cross-section is large. Graphite possesses good mechanical properties at high temperature, it is relatively easy to machine, and it only becomes slightly radioactive when irradiated.

Graphite used in nuclear applications needs to have good mechanical properties, and must therefore be of high density. It must have a good dimensional stability when irradiated, requiring it to be highly isotropic. Finally, it must capture as few neutrons as possible and must retain as low a level as possible of radioactivity when it becomes waste after irradiation, meaning that it must contain few absorbent or activable impurities.

Polycrystalline graphite is used as a structural material in gas-cooled nuclear reactors with a thermal neutron spectrum. The graphite is manufactured as shown in Figure 12 from oil or coal tar pitch coke and a binder. The calcined coke is ground up and sieved. The various size particles are then mixed in the correct proportion to obtain the required density and to allow the evaporation of the volatile components of the binder. The coke mixture is usually mixed with coal tar pitch at 165 °C and either extruded or compressed under unidirectional or isostatic pressure. It is then baked at between 800 °C and 1,200 °C in order to carbonize the binder. The product is then impregnated one or more times, usually with oil tar pitch, in order to increase the density and improve the mechanical properties. Finally, the product is heated to between 2,500 °C and 3,000 °C in order to convert it to graphite with the hexagonal crystalline structure shown in Figure 13. This graphitization process is carried out in the presence of purifying agents (NaF, MgF₂, Cl₂, etc.) in order to obtain nuclear quality graphite with low impurity content.

The type of coke used and the forming techniques used are crucial as they determine the isotropy of the final graphite, and hence the changes in macroscopic properties when exposed to radiation. For an equivalent grain size, coke derived from oil is generally more anisotropic than coke from coal tar pitch.

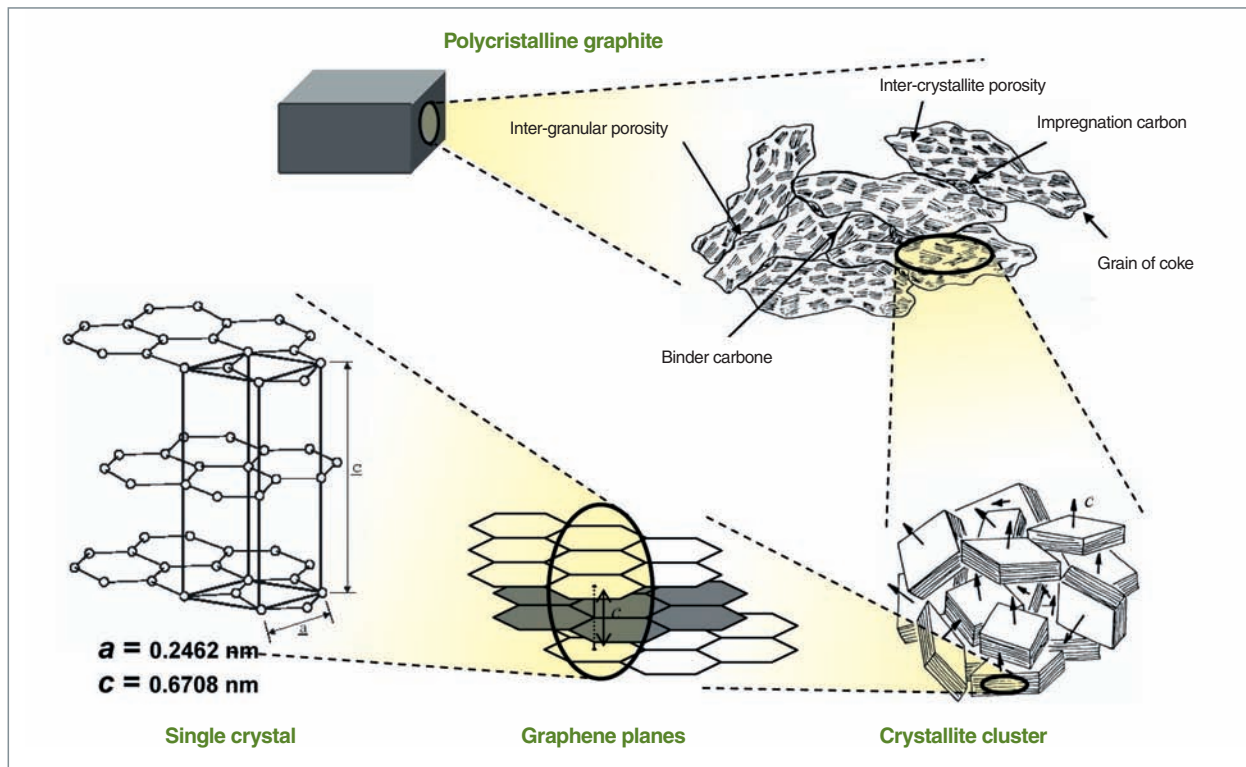

Fig. 13. Structure of graphite.

However, the smaller the grain size, the more isotropic is the final graphite. Anisotropic or quasi-isotropic graphite is formed by extrusion or by unidirectional compression. Isotropic graphite is formed by isostatic compression.

Wigner energy: A problem for reactor safety?

When graphite is irradiated by fast neutrons, some of the carbon atoms are displaced from their equilibrium positions creating interstitial and vacancy defects (see Fig. 14). This phe-

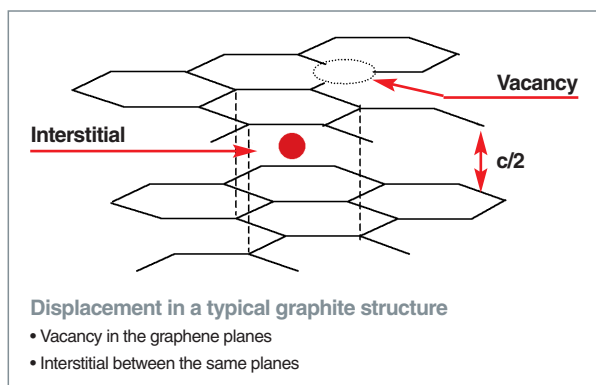

Fig. 14. Irradiation by neutrons displaces carbon atoms to interstitial sites between two graphene planes, leaving vacancies in the planes themselves.

nomenon results in an accumulation of energy known as Wigner energy. The stored energy may reach $2,000 \text{ J.g}^{-1}$. When the atoms return to equilibrium, this energy is released in the form of heat that can raise the temperature of the graphite from ambient to $1,200 \text{ }^\circ\text{C}$. This accumulation of energy constitutes a potential fire risk in air-cooled reactors operating at low temperatures. The absence of preventive measures can result in accidents, such as that which occurred in the experimental Windscale reactor in England in 1957.

At irradiation temperatures below $120 \text{ }^\circ\text{C}$, the isolated defects (1 to 4 atoms) are largely immobile and the stored energy accumulates rapidly. These defects may be healed by raising the temperature. The recombination of the defects is accompanied by the release of heat, resulting in a peak in the differential enthalpy ($dH/d\theta$). This peak is located at around $200 \text{ }^\circ\text{C}$ and it may exceed the specific heat of non-irradiated graphite. Irradiated graphite is energetically stable if the differential enthalpy is lower than the specific heat of non-irradiated graphite at all temperatures. If the graphite is heated, the energy starts to be released above a threshold temperature θ_S . As soon as the trigger temperature θ_D is reached, the temperature rises **adiabatically***, causing the spontaneous release of heat, until the final temperature q_f is reached. The relationship is as follows:

$$\int_{\theta_D}^{\theta_i} \left(\frac{dH}{d\theta} \right) d\theta - \int_{\theta_D}^{\theta_i} C_p(\theta) d\theta = \int_{\theta_i}^{\theta_f} C_p(\theta) d\theta - \int_{\theta_i}^{\theta_f} \left(\frac{dH}{d\theta} \right) d\theta$$

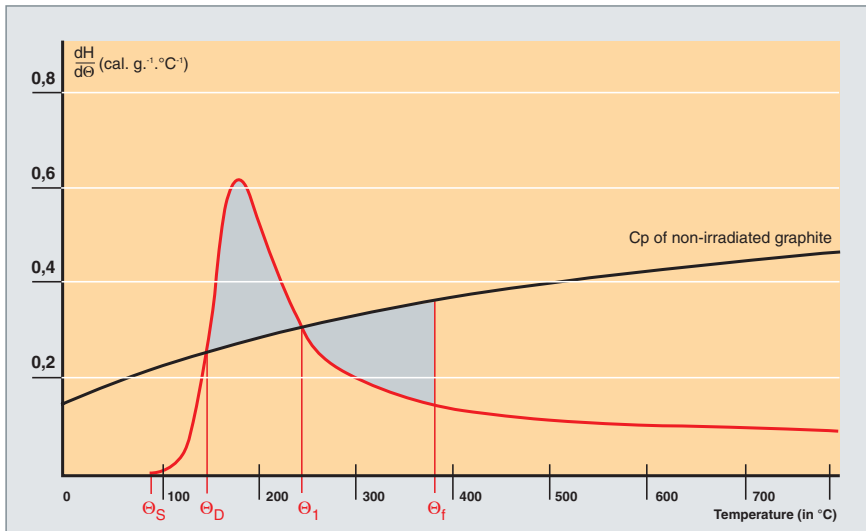

Fig. 15. The Wigner energy spectrum for irradiated graphite at 60 °C having received a neutron fluence of $1.74 \cdot 10^{20}$ n.cm⁻² ϕ FG (*i.e.* 0.12 displacement per atom).

Where θ_1 is the temperature at which the dH/dq curve intersects with the C_p curve for non-irradiated graphite (Fig. 15).

The following two conditions must be met together for graphite to become thermally unstable due to Wigner energy:

- Irradiation temperature less than 115 °C;
- Neutron fluence greater than $1.6 \cdot 10^{20}$ n.cm⁻² ϕ FG⁵, *i.e.* 0.11 displacement per carbon atom.

In practice, for graphite irradiated at between 30 °C and 120 °C, the majority of the stored energy is concentrated in the peak at around 200 °C. The height of this peak decreases as the irradiation temperature increases. At irradiation temperatures above 170 °C, the Wigner energy peak at 200 °C disappears. This means that irradiation defects in graphite do not accumulate at high temperatures, as the defects recombine as fast as they form.

There is therefore no risk of a spontaneous release of Wigner energy for graphite irradiated at above 300 °C.

Behavior of irradiated graphite at high temperature

In future high-temperature reactors, the graphite will be irradiated at temperatures of between 500 °C and 1,200 °C depending on the component concerned. These temperatures are considerably higher than those at which graphite is irradiated in AGR, MAGNOX and NUGG reactors. As has been

shown above, Wigner energy will not be a problem in this type of reactor. However, other phenomena affecting graphite will still have to be taken into account.

Dimensional variations

At the scale of the crystallites, whose size varies according to the crystallographic axis c (L_c) between 20 nm and 140 nm and which behave in a similar manner to monocrystals, the fast neutron flux displaces the carbon atoms to interstitial sites between the graphene planes leaving vacancies in the planes themselves (see Fig. 3). The accumulation of these vacancies leads to a contraction in the crystalline lattice

along axis a , with a corresponding expansion along axis c due to the interstitials. When irradiated, the size of the crystallites along a (L_a) decreases while L_c increases. As the irradiation temperature rises, the mobility of the defects increases and the concentration of isolated interstitials and vacancies falls. The magnitude of the changes in L_a and L_c at a given fluence becomes smaller. Obviously, the dimensional variations in polycrystalline graphite are not completely identical to those of crystallites. The actual variations depend mainly on the following parameters:

- **The irradiation temperature:** Between 300 °C and 700 °C, the graphite contracts in the two preferred directions for polycrystalline graphite (parallel and perpendicular to the graphene planes) with the largest deformation in a direction parallel to the grains (Fig. 16). The rates of deformation as a function of the fluence and the dimensional variations become smaller as the irradiation temperature rises. Above 700 °C, the graphite still contracts in the two directions, but the rate of deformation increases with the irradiation temperature.

- **The size of the crystallites:** The size and perfection of the crystallites increases with the graphitization temperature. The larger the size of the crystallites, the more dimensionally stable is the graphite when irradiated.

- **The isotropy of the graphite:** In general, the rates of deformation as a function of the neutron fluence and the dimensional variations both decrease with increasing graphite isotropy.

5. ϕ FG: Equivalent fission fluence for graphite. A fluence of 10^{21} n.cm⁻² ϕ FG corresponds to a fluence of $0.96 \cdot 10^{21}$ n.cm⁻² ($E > 0.1$ MeV).

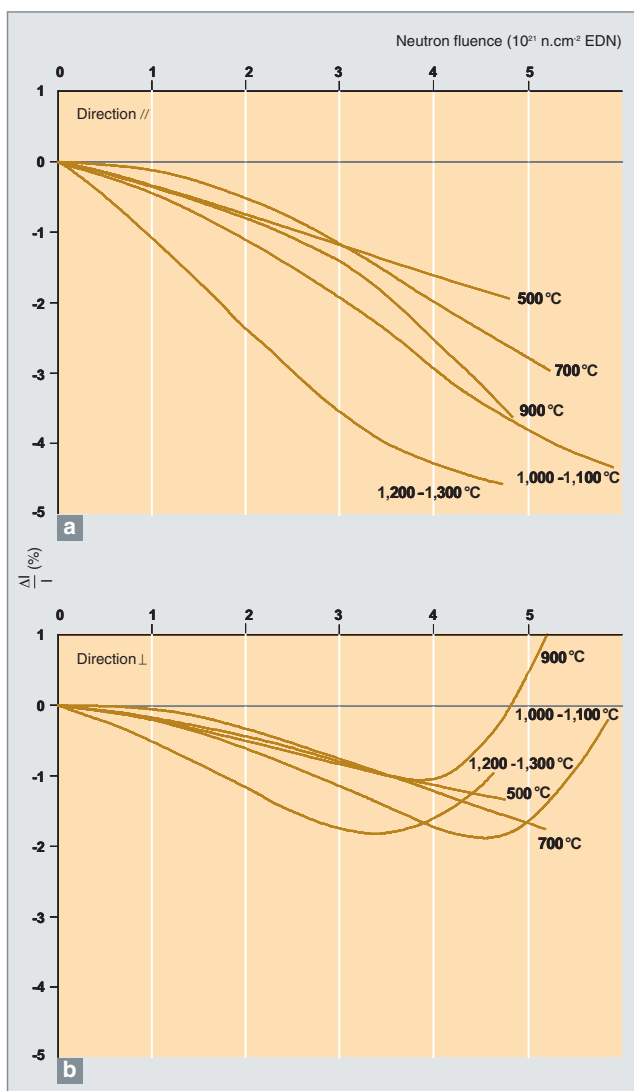

Fig. 16. Relative dimensional variations in quasi-isotropic polycrystalline graphite derived from coal tar pitch coke as a function of the neutron fluence (EDN)⁶ for various irradiation temperatures, a) in the direction of the extrusion; b) in a direction perpendicular to that of the extrusion.

Thermal conductivity

When irradiated, defects are created to a greater or lesser extent in the crystallites. These cause a rapid fall in the mean free path of the phonons. The change in the thermal conductivity of the crystallites is therefore largely dependent on the concentration of isolated vacancies and vacancy loops. The thermal conductivity of polycrystalline graphite begins to degrade at very low levels of neutron fluence (10^{18} n/cm² [$E > 0.1$ MeV]).

6. EDN: Equivalent DIDO Nickel. A fluence of 10^{21} n.cm⁻² (EDN) corresponds to a fluence of $1.76 \cdot 10^{21}$ n.cm⁻² ($E > 0.1$ MeV).

At a given temperature, and in all types of graphite, the thermal conductivity falls monotonically with the fluence at a rate that decreases as the fluence increases (Fig. 17). The thermal conductivity reaches saturation above $4 \cdot 10^{21}$ n.cm⁻² ($E > 0.1$ MeV) for irradiation temperatures of between 500 °C and 1,000 °C.

At a given fluence, the degradation in the thermal conductivity of graphite when irradiated decreases with increasing temperature. At 1,200 °C and a fluence of 10^{21} n.cm⁻², the normalized conductivity (λ_i / λ_0)_{1200 °C} is close to 1.

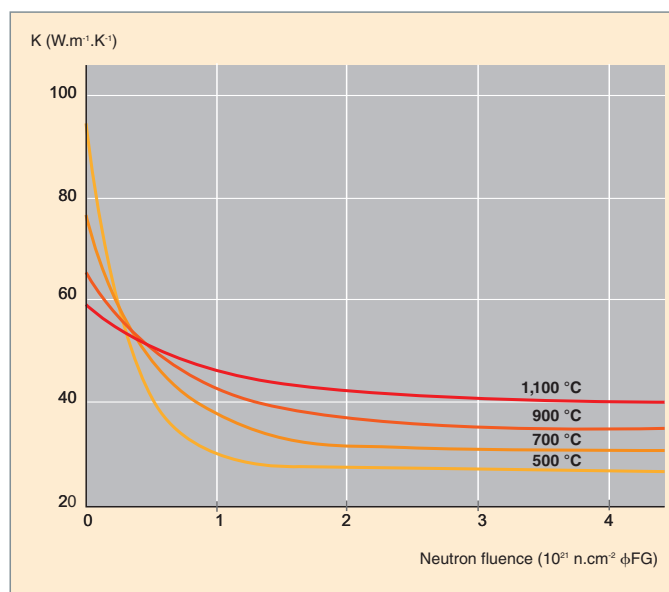

Fig. 17. Variation of the thermal conductivity K of quasi-isotropic polycrystalline graphite derived from coal tar pitch coke in the direction of extrusion as a function of the neutron fluence at various irradiation temperatures. The thermal conductivity is measured at the irradiation temperature.

Elastic modulus

When irradiated, the Young's modulus (E) of polycrystalline graphite increases considerably. This is due to shear movements being blocked by the interstitial defects and may result in the material becoming brittle. This increase begins at low values of fluence, and the effect is greater at lower irradiation temperatures (Fig. 18). When the irradiation temperature increases, the mobility of the defects rises, and the isolated interstitials agglomerate forming new graphene planes. Shear deformations are blocked less and less, limiting the increase in Young's modulus.

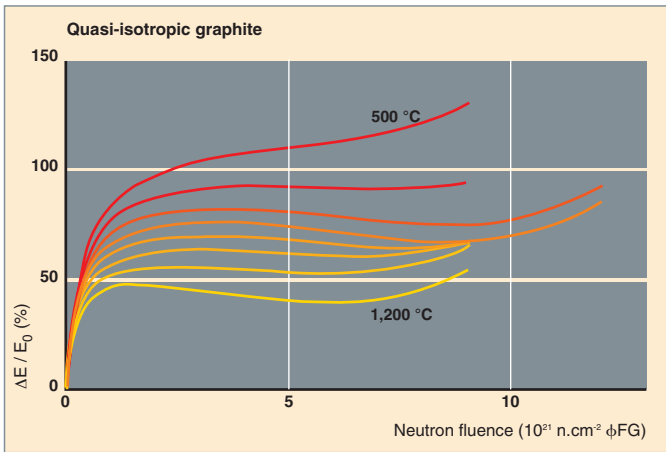

Fig. 18. Relative variation in Young's modulus E_0 of quasi-isotropic polycrystalline graphite derived from coal tar pitch coke as a function of the neutron fluence at various irradiation temperatures.

In the case of quasi-isotropic graphite, irradiated above 300 °C at $3 \cdot 10^{21}$ n.cm⁻² ($E > 0.1$ MeV), the value of Young's modulus remains constant up to $9 \cdot 10^{21}$ n.cm⁻² ($E > 0.1$ MeV). At higher levels of fluence, the value of E again begins to rise due to the closure of the porosity. Finally, above $1.5 \cdot 10^{22}$ n.cm⁻², the value of E falls suddenly as new porosity is generated corresponding to the changeover from contraction to expansion of the graphite.

Radiation-induced creep*

While thermal **creep*** in graphite does not noticeably occur until above 2,000 °C, radiation-induced creep begins at 100 °C and can lead to deformations ten times greater than those occurring without irradiation. The deformation due to radiation-induced creep ϵ_f for graphite is given by:

$$\epsilon_f = \frac{\sigma}{E_0} (1 - e^{-k\gamma}) + k\sigma\gamma$$

where σ is the stress, E_0 is the Young's modulus for graphite, and γ is the **neutron fluence***.

The deformations due to primary and secondary creep correspond to the two terms in the equation. They are both proportional to the applied stress σ .

- Primary creep only occurs at low fluence levels. During this phase, the rate of deformation of the graphite decreases continually. If the stress is removed during this phase, while continuing the irradiation, the deformation ϵ_f is recovered. The deformation can also be recovered by reheating the graphite. There are few measurements available of the primary creep b and these are fairly widely dispersed.

However, it does appear that this value increases with the irradiation temperature.

- The secondary creep is a steady state condition with the rate of deformation constant and dependent on the neutron fluence. The deformation occurring during this phase is permanent and cannot be recovered by removing the applied stress. At irradiation temperatures between 500 °C and 1,400 °C, the secondary creep constant k increases with temperature.

Corrosion of graphite

While the mechanical characteristics of graphite at high temperatures are good, the material is very sensitive to presence of oxidants in the helium. The oxidation of graphite results in a range of gaseous products (CO, CO₂, H₂, etc.) depending on the oxidant gas. This is accompanied by a degradation of the material which, in some cases, can affect the safety of the plant. In the High Temperature (HTR) and Very High Temperature (VHTR) reactors, it is planned to introduce traces of an oxidant (water) into the helium in order to control the coolant chemistry. The main purpose of these oxidants is to maintain a protective film on the surface of the metallic materials. The accident scenarios in this type of reactor envisage a massive entry of air into the coolant circuit. This could occur, for example, following a breach in the hot duct connecting the two vessels in the current designs. It would therefore appear to be essential to understand the behavior of graphite in the presence of oxidants, both in normal operational and incident situations.

In practice, the oxidation of graphite by air is determined by a number of different processes depending on the temperature (Fig. 19).

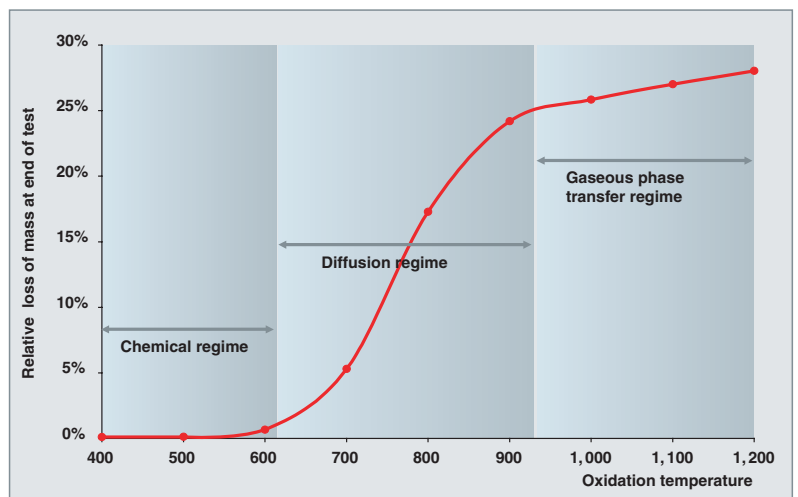

Fig. 19. Oxidation kinetics of graphite in terms of thermogravimetry (relative loss of mass after four hours of oxidation in dry air) as a function of the oxidation temperature (°C).

- At low temperatures, up to around 500 °C – 600 °C, the oxidation of graphite is determined by the chemical reaction between oxygen and the graphite. The oxidation process is slow, but uniform throughout the volume of the graphite component which can lead to a major degradation in the mechanical properties of the graphite. Under these conditions, the presence of certain impurities such as iron, vanadium or lead can act as a catalyst and accelerate the kinetics of the oxidation reaction.
- At higher temperatures, the limiting factor is the diffusion of the gasses in the porosity of the graphite. The rate of oxidation increases, but the depth of penetration into the solid is reduced. The most important parameter from the kinetics point of view is the porosity of the graphite as this controls the access of the oxidant gas to the interior of the graphite. This phase extends from 500 °C – 600 °C up to 900 °C – 1,000 °C, depending on the type of graphite concerned.
- Above 1,000 °C, the oxidation of the graphite is determined by the supply of gas to the surface of the sample, as the rate of transportation of the oxidants through the porous material

increases at a slower rate with temperature than that of the reaction between oxygen and graphite. The oxidation process is more rapid and it progresses from the outside of the sample. The mechanical properties are therefore less affected directly other than by the reduction in the overall size of the sample.

Experience has shown that it is extremely difficult to use the measurements taken on one type of graphite under a given set of conditions as a basis for extrapolation to cover the oxidation of graphite under all conditions, given the number of factors intrinsic to the material and associated with the gaseous atmosphere.

The choice of an acceptable type of graphite for use in a reactor, especially from a safety point of view, must be based on an analysis of the behavior of the most likely candidates in an oxidant atmosphere, coupled with an analysis of their mechanical characteristics.

Jean-Pierre BONAL
Nuclear Materials Department

Jean-Charles ROBIN
Nuclear Technology Department

The recent past and near future of gas-cooled reactors: HTRs

High-Temperature Reactors (HTRs) differ drastically from first-generation gas-cooled graphite-moderated reactors (GCRs, MAGNOX reactors and AGRs) in that they use a finely divided **coated-particle** fuel and a new gas coolant: **high-pressure helium**.

The combined use of a refractory fuel and a chemically inert coolant allows HTRs to operate at high temperature (above 800 °C) with high thermodynamic efficiency. In addition, the very high irradiation resistance of the particle fuel allows very high **burn-up***. The specific composition of the fuel also provides high operating flexibility and makes HTRs well suited for consuming various types of nuclear materials.

As in the case of first-generation gas-cooled graphite-moderated reactors, the use of a graphite moderator imposes a low power density. The large mass of graphite contained in the core gives HTRs a significant thermal inertia. These two characteristics are theoretically economically penalizing, but combined together they give HTRs interesting safety characteristics.

More recent modular designs further increase the advantage of HTRs regarding safety, cost-effectiveness and industrial deployment. Finally, the use of gas turbines allows a direct energy conversion cycle (Brayton cycle), further improving the efficiency and compactness of the system. These are the reasons that contribute to the renewal of interest in HTRs.

	MAGNOX*	GCR*	AGR*	HTR*
Unit power (MWe)	50-600	45-500	600	200-1,000
Electrical efficiency (%)	31	28-30	42	48
Coolant	CO ₂	CO ₂	CO ₂	He
Pressure (bar)	28	29	40	50-70
Outlet temperature (°C)	approx. 400	approx. 400	645	750-950
Moderator	Graphite	Graphite	Graphite	Graphite
Core power density (MW/m ³)	0.5-1	1	3	2-7
Fissile material	Natural uranium	Natural uranium	Low enriched U	Enriched uranium
Fuel element	Metal fuel rod with Mg alloy cladding	Metal fuel rod with Mg alloy cladding	Steel-clad oxide pellets	Particle coated with SiC and graphite
Burn-up (GWd/t)	3.5-4.5	6.5	18 - 20	100 or far greater

Comparison of the characteristics of different gas-cooled reactor systems, showing the advantages of HTRs with respect to first-generation graphite-moderated gas-cooled reactors.

	HTR*	Boiling water reactor*	Pressurized water reactor*	Sodium-cooled fast reactor*
Unit power (MWe)	200-1,000	1,100	1,450	1,200
Efficiency (%)	48	33	33	41
Coolant	He	Water	Water	Na
Pressure (bar)	50-70	70	155	1-4
Inlet temperature (°C)	400	278	290	390
Outlet temperature (°C)	750-950	287	325	550
Moderator	Graphite	Water	Water	None
Core power density (MW/m ³)	2-7	50	100	250
Burn-up (GWd/t)	100-800	30	60	100-200

Comparison of main nuclear reactor systems, showing the very specific characteristics of HTRs.

HTR design principles

Particle fuel

The use of a particle fuel is the major innovation of HTRs. First conceived in the early 1950's by Harwell researchers in the UK, this fuel consists of a small sphere of millimetric diameter comprising a fissile material kernel, possibly **fertile***, coated with various layers of refractory materials.

In the reference designs currently adopted, the core is composed of actinide oxide and coated with 4 layers of different materials (Fig. 20). Starting from the fuel kernel, first there is a **buffer** layer of porous carbon serving as a reservoir for fission gases released by the kernel and as a protective buffer for the external layers, followed by two layers of dense pyrolytic carbon contributing to the mechanical resistance of the particle and separated by a layer of silicon carbide that serves as a fission product diffusion barrier.

This design offers very high flexibility in terms of geometric parameters, arrangement of layers and choice of materials.

These particles are not disposed freely within the core. Instead, they are agglomerated within a carbon matrix so as to constitute manipulable objects. This agglomeration may consist of small cylinders 1 to 2 centimeters in diameter and 5 to 6 centimeters long, referred to as compacts, placed in channels within hexagonal graphite blocks also pierced with cooling channels to allow the passage of cooling helium. This is the American design. In the German design, these particles are conditioned in spherical graphite matrixes approximately 6 centimeters in diameter, referred to as pebbles. The core is then constituted by bulk piling of these pebbles, with the cooling helium circulating in the free spaces.

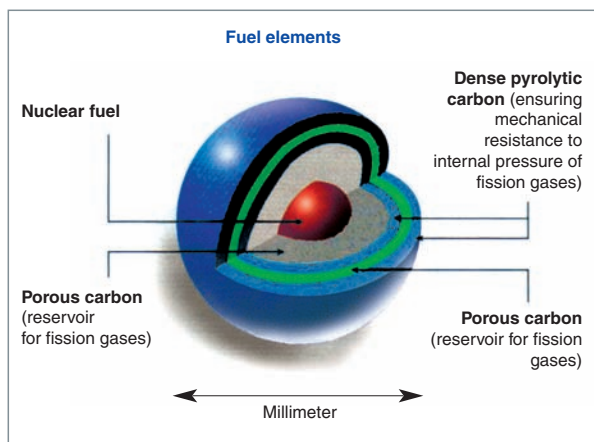

Fig. 20. TRISO* particle.

This results in very significant dilution of the fuel in the **core***, *i.e.*, first in the particles, with the actinide kernel representing only 10 to 15% of the volume, and then in the compacts or pebbles, where it amounts to only a few %. These designs are clearly associated with low core power densities (approximately 5 MW/m³, as compared to 100 MW/m³ for water-cooled reactors).

An HTR core will contain considerable quantities of particles (billions). This greatly modifies the fuel concept, since performance will be assessed statistically.

The fuel fabrication process comprises three different steps: fabrication of kernels (sol-gel or dry agglomeration process), fabrication of coatings (CVD, vapor phase chemical process), and fabrication of graphite matrixes, compacts or pebbles. Specific analyses and characterizations of samples (statistical inspections) are required during each stage. In addition to verifying the geometry (diameter, sphericity and thickness of the various layers), these inspections must ensure that the fraction of non-sealed particles is less than 10⁻⁵. These inspections are an essential part of the HTR fuel fabrication process and have required the development of reliable and economically realistic methods for large-scale production.

Moderator and structural graphite

The graphite in which the particles are diluted acts both as a structural element and a moderator. In addition, the core itself is surrounded by replaceable or permanent graphite reflector elements. The core and its reflectors rest on large support structures also made of graphite. These different functions are clearly associated with different stresses (thermal stress, mechanical stress, irradiation effects, etc.) and therefore different specifications. As a result, various grades of graphite may be used in an HTR.

Graphite purity is an important parameter to ensure moderation performance, and also to limit the contamination of the gas by corrosion or activation products possibly generated during operation. Large quantities of graphite are introduced (due to its moderation characteristics), hence the significant dilution of the fuel.

Graphite is highly refractory and a good heat conductor. It exhibits interesting mechanical properties at high temperatures.

The helium inlet temperature (approximately 400 °C) prevents the Wigner effect, but irradiation significantly reduces the thermal conductivity of the graphites, increases their creep capacity, and causes dimensional variations (contraction followed by swelling). This is what limits their lifetime in the reactor.

Graphite is intrinsically oxidizable. The safety analysis must therefore cover potential air or water ingress problems, minimising or even preventing them in the design. Oxidation behavior is highly sensitive to the content of certain impurities, so these must be minimised.

The **temperature coefficient*** of the moderator is generally highly negative, which has a stabilizing effect on the core.

He coolant

Helium and CO₂ are the only coolant gases currently used in gas-cooled reactor projects, and only helium is used for high-temperature research activities, mainly due to the temperature limitations of CO₂ with regard to graphite corrosion problems (at temperatures above 500 °C).

Helium is chemically neutral and does not exhibit phase changes. It is nearly transparent to neutrons, which limits the reactivity effects associated with variations in coolant density (*e.g.*, depressurization) to negligible values. It does not become radioactive and is not subject to radiolysis under irradiation (with the exception of the tritium formed by neutron capture in He 3 impurities).

It is one of the gases with the highest heat transfer and transport coefficients (specific heat, thermal conductivity). The operating pressure is determined by considerations of core energy extraction (low density of helium) and thermodynamic efficiency, the optimal value being approximately 7 MPa (using a direct cycle), as observed in recent projects.

Helium diffuses very easily, which calls for particular vigilance with regard to static and dynamic sealing problems. Past experience shows that there are technological solutions for circuits and components to reduce leak rates to acceptable levels (a few % per year).

HTR performance

Fuel

The performance of the particle fuel used in HTRs has been proven in numerous irradiation experiments in the United States and Europe. Since each sample irradiated comprises a few thousand particles, the results obtained have a statistical value that allows them to be transposed to power reactors. Highly varied microstructures have been tested. The recognized performance characteristics of the particle fuel are as follows:

- Excellent confinement of fission products (except silver) and very low particle failure rate up to 1,800 °C. Operating temperatures remain low (below 1,200 °C) due to the good thermal conductivity of graphite and the low power density. They are well below the technological limits, namely the maximum

temperature of 1,600 °C permitted under accident conditions;

- Temperature limit associated with the degradation of the SiC, which loses its efficiency at temperatures above 1,800 °C and decomposes at 2,200 °C. Replacing the SiC with ZrC, which is even more stable, could further increase the temperature limits of the particle fuel;
- Extremely high burn-up capability. In certain experiments, burn-ups of 780 GWd/t have been achieved without apparent damage to the particles. This allows for the possibility of consuming certain actinides such as plutonium.

The mechanical resistance of the particles composing it makes the HTR fuel difficult to reprocess. This can be penalizing when it is used in material recycling strategies such as the U/Th regeneration cycle at one point considered for HTRs. However, it can be considered as an advantage for applications where the objective is to burn or consume materials for achieving very high burn-ups. The resulting spent fuel has a very low residual energy and may possibly be stored as such, if current studies confirm that the excellent confinement of fission products by the particle coating layers is maintained over long periods of time.

Neutronics and fuel cycles

HTRs offer the advantage of accepting a large variety of mixtures of fissile and fertile materials without significant changes in core design. This flexibility is mainly due to the separation of the parameters determining the cooling geometry from those characterizing neutronic optimisation (concentration and distribution of heavy nuclei, or moderation ratio). It is possible to influence the replenishment rate of the coated particles in the graphite matrix composing the fuel without modifying the dimensions of the fuel elements (number and diameter of cooling holes in prismatic blocks, or outside diameter of pellets). It is also possible to vary the size of the nuclei or even the relative proportion of various types of particles containing different nuclear materials.

HTRs also allow the freedom to choose the distribution and concentration of fissile and fertile materials, which determine two fundamental neutronic parameters: **moderation ratio*** and **self-shielding***. Other more physical factors favor the fuel-cycle adaptability of HTRs, as compared to reactors using a liquid moderator, such as water-cooled reactors. For example, the drainage effect that limits the plutonium content in **MOX*** fuels for water-cooled reactors is obviously absent in a graphite-moderated reactor. In addition, HTRs have a far better neutron economy than PWRs due to the significant reduction of sterile captures in the graphite moderator (100 times less neutron captures than in water), in the structural materials (no metallic materials capturing neutrons) and in the fission products (due to the harder spectrum, whereas fission products ensure better capture of thermal neutrons).

Safety

The excellent fuel performance, refractory fuel materials, acceptable thermal conductivity, low specific power, high thermal inertia and highly negative moderator **temperature coefficient***, combined with the virtual absence of coolant density effects, are the main characteristics that make HTRs safer than existing reactors and particularly well suited to satisfy the requirements of future reactors.

Fission product confinement is an essential safety requirement for any nuclear facility. This is ensured through proper observance of the maximum fuel temperature of 1,600 °C for all accident conditions taken into account in the design.

The observance of this requirement is associated with two main safety functions:

- **Reactivity*** control, to prevent unacceptable **power excursions***. This is ensured by a highly negative temperature coefficient and practically negligible coolant density effects. In addition, the absence of phase change in helium eliminates brutal variations in reactivity or thermal exchange conditions. Risks of criticality through core reconfiguration are deemed inexistent for these types of reactors;
- Evacuation of heat generated (normal and residual), to prevent core overheating. Recent small reactor designs have further increased the ability of HTRs to offer very safe passive mechanisms using the inherent properties of the concept, namely to extract **residual power*** in case of interruption of cooling;
- The good thermal conductivity provides a significant margin between the fuel operating temperature and the temperatures possibly induced by a degradation of its condition;
- This good thermal conductivity combined with a low specific power and an annular core surrounded by reflectors conferring high thermal inertia (significant graphite mass) make it possible to store residual power and then transfer it to the exterior merely through physical conduction and radiation phenomena.

It has been shown that the temperatures thus attained by the pressure vessel radiating towards cooling panels in the reactor pits does not exceed the temperature limits required to ensure mechanical resistance.

These sequences do not require the presence of helium. As a result, HTRs are the only reactors that do not require a coolant to evacuate residual power (*i.e.*, the gas in HTRs does not ensure a safety function).

This simplicity clearly eliminates the need for a large number of active safety systems that are essential in conventional reactors, thereby contributing to the economic competitiveness of HTRs.

The possibility of using a non-sealed ventilated building (under certain conditions) provides an additional advantage with regard to economic competitiveness. The fuel's excellent capacity to retain fission products (associated with the observance of the 1,600 °C limit for all accident situations taken into account in the design) has led certain manufacturers to deduce that the doses received by workers and the public would remain below regulatory limits without requiring leak tightness of the reactor building. This is the case with the GT-MHR project presented by General Atomics, as well as the PBMR project developed by Eskom in South Africa.

In HTRs, an additional function needs to be analyzed: control of core degradation due to chemical reactions. Even though water ingress has been significantly minimised or even eliminated using the direct Brayton cycle, the impact of air ingress (from the reactor building) further to accidental depressurization needs to be carefully established. Nevertheless, it has been shown that such a scenario (highly improbable) only causes limited oxidation of the graphite present in the core, without affecting the fuel particles.

HTRs worldwide, and operation feedback

The first HTR built was the Dragon experimental reactor (20 MWth). It went critical at Winfrith (UK) in 1964 and operated until 1975, demonstrating the feasibility of HTRs. This first implementation, conducted in an international context under the aegis of the OECD, led the way by introducing HTRs in Europe and arousing interest in the United States and subsequently Japan. The most interesting operating experience concerns the particle fuel behavior, the operation of the reactor coolant system, and the manipulation of the core components.

Further development was pursued symmetrically in the United States for prismatic fuel reactors and in Germany for pebble bed reactors (Fig. 21). First two demonstration reactors were built (Peach Bottom and AVR), followed by two 300 MWe steam cycle prototype reactors (Fort Saint-Vrain and THTR300). These prototypes were intended to precede higher power reactors (500 to 1,200 MWe) in both the United States and Germany, which were never built.

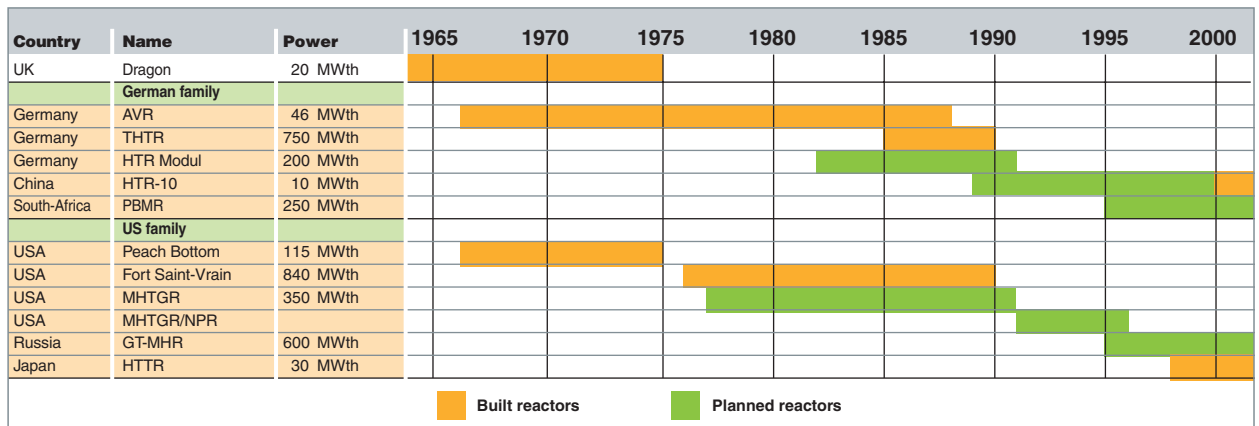

Fig. 21. HTRs worldwide (above) and main characteristics of HTRs built (below).

	Dragon	Peach-Bottom	AVR	Fort St-Vrain	THTR300	HTTR	HTR10
Site	Winfrith (UK)	Pennsylvania (US)	Jülich (Germany)	Colorado (US)	Schmehausen (Germany)	Oarai (Japan)	(China)
Criticality	1964	1966	1966	1974	1983	1998	2001
Shutdown	1975	1974	1988	1989	1989	-	-
MWth	20	115.5	46	842	750	30	10
MWe		40	15	330	300		
He Pressure (bars)	20	24,6	10	48	40	40	30
Inlet temperature (°C)	335	343	175	406	262	395	250-300
Outlet temperature (°C)	835	715	850	785	750	850-950	700-900
Power density (MW/m³)	14	8.3	2.3	6.3	6	2.5	2
Fuel elements	Prisms	Prisms	Pellets	Prisms	Pellets	Prisms	Pellets
Cycle	Varied	U/Th	U 235/Th	U 235/Th	U 235/Th	Enriched U	Enriched U

Pebble bed reactors

The main characteristic of the German design is the conditioning of compacted microparticles in a graphite matrix in the form of 60-mm diameter spheres (Fig. 22). They are continuously inserted in and extracted from the reactor at a rate of one pebble approximately every 20 seconds. When a pebble reaches its maximum depletion rate, it is replaced with a new one.

The first German HTR was the AVR built at the Jülich research center. This center has maintained very high competence in this technology. The AVR set new records (for HTRs) in terms of performance and operating duration. Its construction began in 1961. It was connected to the electric power network in 1966 (15 MWe) and shut down in 1988. It served as an experimental platform for fuel technology development within the scope of cooperation between the Jülich research center and NUKEM, the fuel industrial manufacturer still considered as a reference today. The core temperature of 850 °C at the start of operation was increased to 950 °C. The steel pressure vessel design served to achieve design **transients*** (e.g., core cooling loss) that contributed to validating the safety concepts applied in this type of reactor.

The AVR showed the viability of the pebble bed concept and demonstrated its reliability through physical tests for which the plant was not initially designed. A loss of coolant flow without scram was simulated in 1970, and a loss of coolant transient was also achieved prior to final shutdown.

The fuel has undergone significant developments and improvements at the Jülich center, in partnership with NUKEM (manufacturer).

The second HTR built in Germany was the THTR-300 (Thorium High-Temperature Reactor), which went critical in 1983. This was a 300 MWe commercial reactor with a concrete vessel, built by Brown Boveri. The operation of the THTR was marked by a number of technical problems that did not seem impossible to overcome. In particular, a planned inspection in 1988 revealed the rupture of a number of bolts securing hot duct insulation plates which, combined with an unfavorable political context, led to the decision to permanently decommission the facility in 1989 after only 423 equivalent full power days (EFPD*).

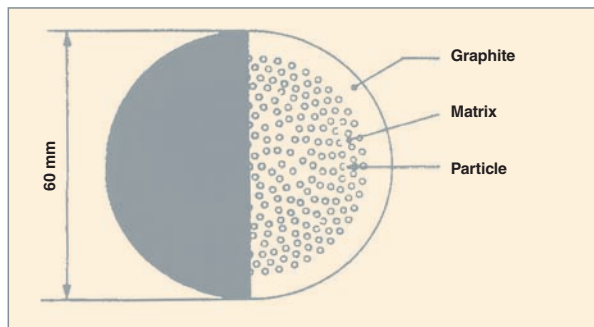

Fig. 22. Fuel pebble.

Prismatic reactors

The American family differs from the German family mainly in terms of core and fuel organization. The core is composed of prismatic graphite blocks containing the fuel compacts (Fig. 23).

The first commercial implementation was Peach Bottom (40 MWe), which went critical in early 1966 and was shut down in 1974. After the discovery of an increasing number of fuel cladding ruptures, a second core was fabricated using a more advanced technology improving the quality of the first porous graphite layer and the characteristics of successive layers. 93% availability was achieved during irradiation of this second core, and reactor coolant system activity remained extremely low, indicating the excellent quality of the new fuel. The reactor subsequently operated without major problems and was shut down for economic reasons.

The second implementation was Fort Saint-Vrain (330 MWe), whose construction began in 1968 and which went critical in 1974. Its operation was marked by technical problems (namely accidental water ingress in the reactor coolant system causing accelerated corrosion of steel components and poor availability) and it was finally decommissioned in 1989. Despite the negative functional aspects of its operation, the excellent leaktightness of the fuel elements led to very positive radiological results for operation and maintenance activities, with the exception of tritium releases due to water leaks.

Simultaneously with the construction of Fort Saint-Vrain, several orders were placed with General Atomics in the early 1970's, but they were quickly canceled as these reactors did not seem economically competitive with regard to water-cooled reactors.

On the whole, the operating experience from German and American prototypes has largely confirmed the technical expectations regarding HTRs, *i.e.*:

- Very good behavior of the particle fuel under irradiation, even at high temperatures, and low release of fission products in the coolant gas providing very clean reactors;
- Possibility of using high-temperature helium as coolant gas;
- Easy control, high thermal inertia and significant operating safety margins (demonstrated at real scale with the AVR).

The operating difficulties of Fort Saint-Vrain and the THTR are due to solvable and minor technological problems or design flaws. The main reason HTRs have not been industrially deployed is that they were not economically competitive at the time of the worldwide industrial breakthrough of water-cooled reactors.

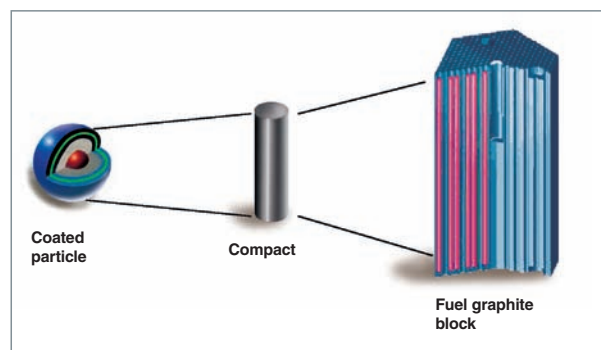

Fig. 23. Multilayer fuel particles and prismatic blocks.

Recent evolution: Numerous new projects

The aborted HTR projects contemporary of the Fort Saint-Vrain and Peach Bottom prototypes aimed to achieve high power output (770 and 1,160 MWe for the American projects), probably to compete with the already largely implemented water-cooled reactors, and still operated using a steam cycle.

More recent context factors led the United States to renew the concept of modular reactors in the 1980's so as to eliminate the scale effect through standardization and in-factory production of low-power modules progressively assembled to constitute a high-power unit. This theoretically makes it possible to limit financial risks (through better control of manufacturing schedules) and start producing energy while the next modules are being built.

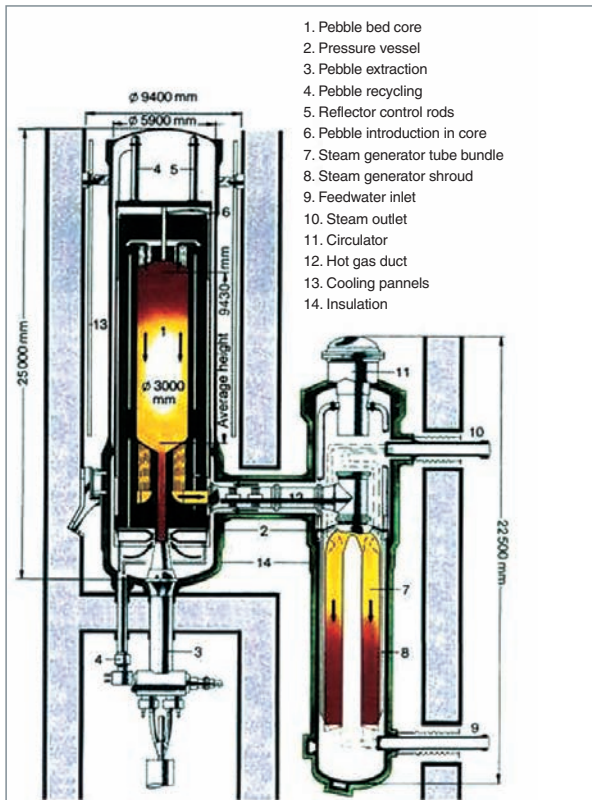

Fig. 24. German HTR-Modul project.

In addition, the impact of the Three Mile Island accident and the excellent intrinsic safety characteristics of HTRs (thermal inertia, good apparent core conductivity, low power density) have led to research on configurations allowing completely passive residual power evacuation. Low-power HTRs are particularly well suited to satisfy this new **passive safety** requirement.

As of 1982, Interatom (Siemens subsidiary), developed the **HTR-Modul*** (Fig. 24), an innovative concept based on the technology developed by the Jülich research center. This 80 MWe reactor uses the radiating capacity of a metal vessel to ensure passive cooling of the fuel, whose temperature remains below 1,600 °C regardless of accident conditions. A detailed design has been completed.

The discontinuation of financial support from electricity producers and industrial partners led Siemens to interrupt these developments. Further to an agreement with the German government, Siemens and ABB have created HTR GmbH, a common subsidiary serving as a platform for all German technologies, including the NUKEM fuel fabrication technology (which has been transferred to China and South Africa for the development of their HTR programs).

Simultaneously with these developments, the industrial progress achieved with gas turbines and high-temperature materials has opened the way for direct-cycle HTRs, offering new perspectives for improved thermodynamic efficiency. In addition, the high-temperature characteristics of HTRs favor their use for massive hydrogen production applications using thermochemical processes, and significant developments in heat exchanger and magnetic bearing technologies have enabled the design of more compact, cleaner and safer plants.

These factors have led to the development of modular **direct-cycle*** HTR concepts, illustrated by industrial projects such as the **GT-MHR*** designed by General Atomics (Fig. 29 et 30) and the **PBMR*** developed by Eskom in South Africa (Fig. 30).

The current design trends for HTRs are therefore the following:

- Modular reactors with unit power ranging from 100 to 300 MWe;
- Direct-cycle operation according to the Brayton cycle;
- Passive residual power evacuation without any reliance on the coolant fluid.

Learning from the negative experience of Fort Saint-Vrain, General Atomics developed its concept and proposed a tritium production reactor (MHTGR) to the American government in the early 1990's. This option was abandoned, and General Atomics subsequently established a partnership with Minatom (Russia) for the development of the GT-MHR, designed to consume excess military plutonium. An agreement on the basic design was signed in 1995 and included the participation of Framatome and Fuji Electric.

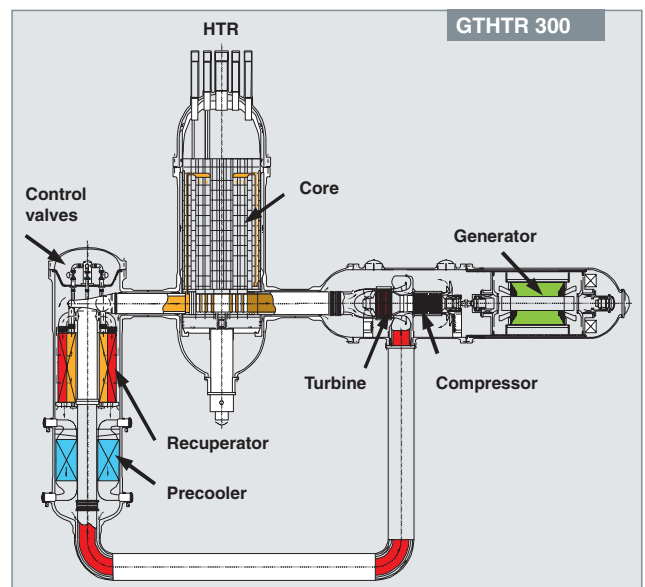

Fig. 25. Japanese GTHTR-300 project.

The GT-MHR has an annular core geometry favoring heat transfer (through conduction) and storage (in the internal and external reflectors). The use of a non-cooled steel vessel allows thermal transfer through radiation towards external cooling panels using natural convection of water. To accommodate the highly improbable hypothesis of the failure of all cooling panels, heat conduction in the ground around the silos is sufficient to maintain the fuel temperature at acceptable values.

The GT-MHR power output (600 MWth, corresponding to approximately 280 MWe), core geometry and pressure vessel dimensions are optimised so that the maximum fuel particle temperature during a residual power evacuation transient without coolant gas does not exceed 1,600 °C (at which tem-

perature the microparticles maintain their integrity and continue to ensure fission product retention).

In 1993, ESKOM (South African electricity producer) decided to explore HTR technology and initiated the development of the **PBMR*** (Pebble Bed Modular Reactor), licensed by HTR GmbH and with the assistance of the Jülich research center. This reactor combines Interatom's HTR-MODUL concept with a direct-cycle gas turbine. Support for its development was rapidly obtained from the South African government. The search for development funds led to strong media coverage, and BNFL (UK) and EXELON (USA) contributed to financing the studies. EXELON withdrew from the group in 2002. PBMR Co. (ESKOM subsidiary aiming to sell reactors) completed the detailed design of the PBMR in late 2003 and is now searching for funding to build a demonstrator in South Africa.

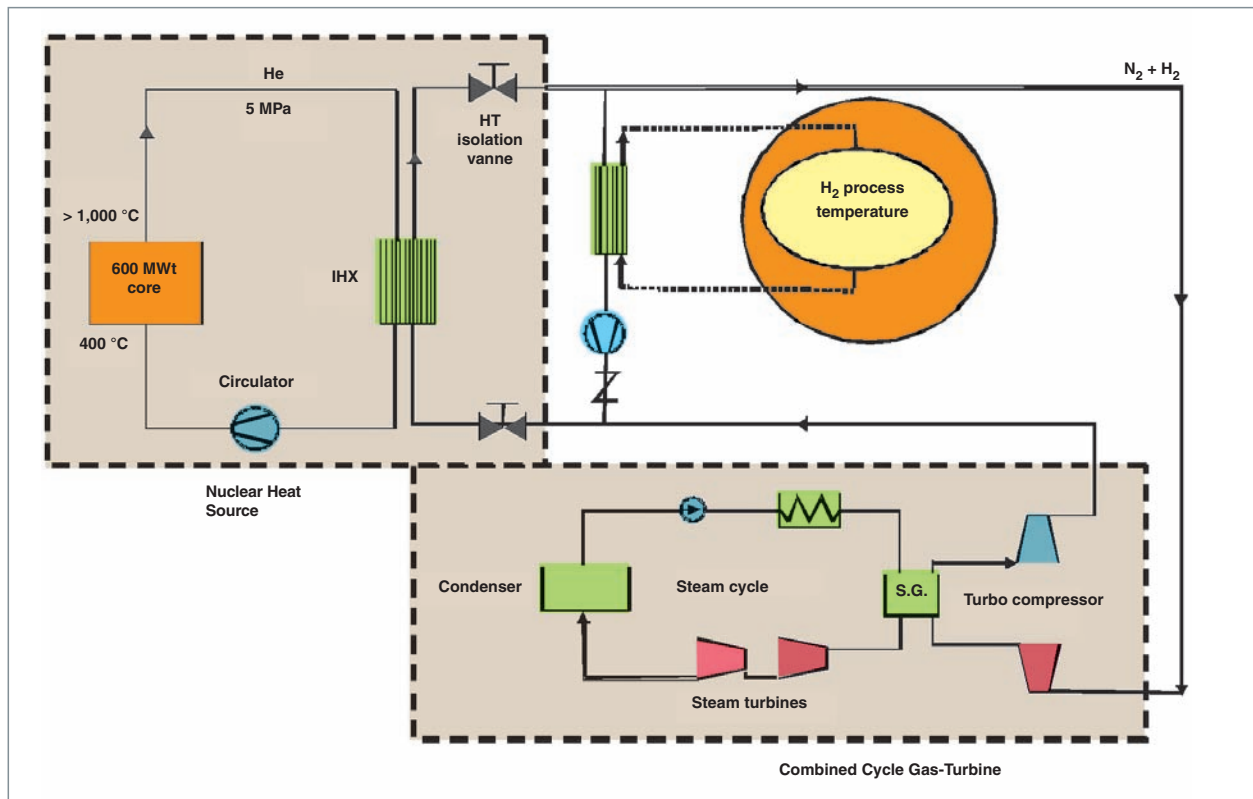

Fig. 26. Basic diagram of the ANTARES project. Due to the technological difficulties associated with the design and construction of a helium-cooled turbocharger, the ANTARES project is based on the implementation of an indirect cycle with an intermediate heat exchanger and a secondary circuit using nitrogen (whose properties are similar to those of air). This concept makes use of proven air turbine and compressor technologies. AREVA adds 20% helium to the nitrogen carrier gas so as to improve its exchange properties. This has the advantage of optimising the intermediate heat exchanger design without significantly affecting the conventional turbocharger technology implemented. The energy conversion system used in the ANTARES project implements a combined cycle consisting of a variation of the Brayton cycle with the turbine exhaust recuperator replaced by a steam generator powering a steam turbine. This combined cycle is similar to the one intended for combustion gas turbines, except that it uses a

closed gas cycle. Efficiency is excellent, since the system benefits from the advantages of the gas cycle for high temperatures and also those of the steam cycle for low temperatures, namely due to the ability to condensate steam at the heat sink. Gross and net efficiencies in excess of 50 and 46%, respectively, can be achieved, at the cost of a certain apparent complexity as compared to a Brayton cycle with recuperator. Since a proven combined cycle technology is used, this apparent complexity does not necessarily lead to a higher cost than the Brayton cycle with recuperator, which remains to be developed and whose cost is not yet known. Moreover, this particularly flexible concept is well-suited for cogeneration configurations, possibly representing most of the market for these reactors.

At the same time, Japan (JAERI) has engaged in HTR development activities, with hydrogen production as the main objective. It has adopted the American technology for the core design and the German technology for the fabrication of microparticles. **The HTTR* (30 MWth)** went critical in 1998. Its operating temperature (initially 850 °C) has been increased to 950 °C for a limited period. The HTTR will be used as a test facility for fuel elements, high-temperature irradiation of materials and demonstrations of industrial heat applications. It should be eventually linked to a hydrogen production unit.

Various concepts comprising a high-temperature modular reactor linked to a gas turbine are currently being developed in Japan. These projects are coordinated with HTTR developments.

They include the **GTHTR-300*** (Fig. 25), a 600 MWth reactor using a direct-cycle turbine. One of its specific characteristics is the presence of three main vessels, one for the core, one for the turbomachine and one for the heat exchangers. The core is composed of hexagonal graphite blocks.

The latest reactor built using German technology is the **HTR-10*** in China. It is installed at Tsin Hua – INET University in Peking. It has a power output rating of 10 MWth and went critical in 2001. Its construction should increase China's knowledge and control of these reactors systems. After a series of tests and experiments, the reactor will be linked to a gas turbine (after 2005). Its fuel is fabricated in China using equipment transferred from a German fabrication plant.

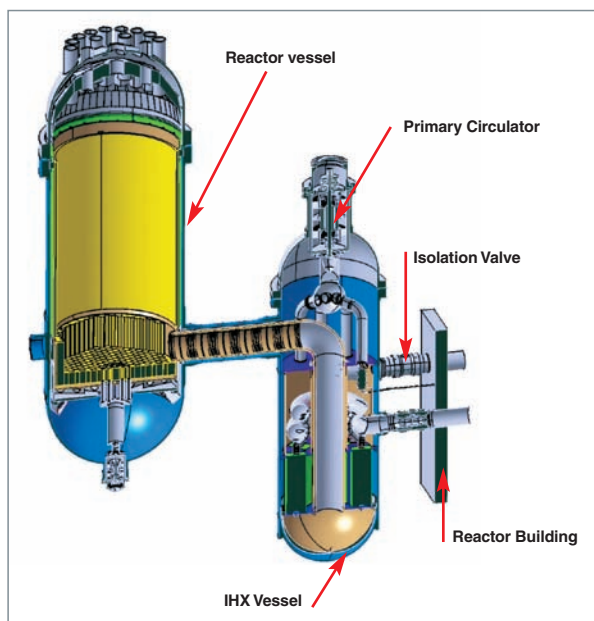

Fig. 27. Framatome-ANP ANTARES project (nuclear island).

Benefiting from the experience acquired through the development of the HTR-MODUL in Germany during the 1980's, its participation in the GT-MHR studies with General Atomics, Minatom and Fuji Electric, and the support of the CEA for all R&D activities, Framatome-ANP proposes an innovative indirect cycle concept using combined cycle gas turbine technology. A basic diagram of the ANTARES project is shown in Figure 26. It includes an optional bypass of a fraction of the power for hydrogen production. Figure 27 presents a general view of the nuclear island, showing the reactor vessel and the vessel containing the intermediate heat exchanger.

Comparison of two third-generation reactor projects: GT-MHR and PBMR

These two reactors have undergone detailed design these past years and perfectly illustrate the main design options available for HTRs in the near future. The consortiums developing them are currently seeking funding to build the first demonstrator and thus facilitate industrial deployment in the world market.

These two reactors have a number of common characteristics different from those of previous HTRs:

- They are equipped with a steel pressure vessel that maintains the fuel temperature below 1,600 °C (through heat radiation) during design-basis accident conditions (*i.e.*, helium pipe rupture with loss of electrical power supply and without emergency shutdown);
- They use a direct Brayton cycle with a gas turbine.

Their main differences are the following:

- The core power density is lower in the PBMR, due to the random distribution of the fuel pellets. In the GT-MHR, the power distribution is well known and controlled, allowing a higher mean core power density;
- In the GT-MHR, the turbogenerator and the LP and HP compressors are on the same shaft line. In the PBMR, they are three different components (Fig. 28);
- The PBMR designers have chosen conventional steels for the pressure vessel and turbo-generator. This requires cooling by specific helium circuits (at the cost of a loss of electrical production efficiency) but has the obvious advantage of reducing development time and costs. For the GT-MHR, General Atomics has chosen a 9Cr steel with better temperature resistance characteristics, but requiring specific development and qualification;
- The continuous refueling of the PBMR leads to better use of the fuel and allows for lower uranium enrichment (approximately 8.5% vs. approximately 12% in the GT-MHR for one-

Description	Unit	PBMR	GT-MHR Pu	GT-MHR U
Net electrical power	MWe	165	278	
Total power	MW	400	600	
Efficiency	%	41.2	46.3	
Facility lifetime	Years	40	60	
Reactor coolant flowrate	Kg/s	140	316	
Reactor system pressure	MPa	8	7	
Coolant temperature at core inlet	°C	536	488	
Coolant temperature at core outlet	°C	900	850	
Core dimensions	Inside diameter	m	2.00	2.96
	Outside diameter	m	3.70	4.84
	Height	m	11.0	8.00
Core power density	MW/m ³	4.8	6.5	
Core refueling fraction		Continuous refueling	1/3	1/2
Diameter of fuel pebbles	mm	60	-	
Diameter of fuel compacts	mm	-	12.5	
Height of fuel compacts	mm	-	49.3	
Fuel		UO ₂	Military PuO ₂	UO ₂
Enrichment	%	8.5	12	
Consumable poison	-		Ernat	

Comparison of the main characteristics of the GT-MHR and PBMR.

year cycles). On the other hand, for an equivalent size, the GT-MHR allows higher power (see power density in table above), thus improving economic performance (which is the weak point of the PBMR).

- The integration of the compressors, turbine and generator on the same shaft line in the GT-MHR is a major initiative. The benefit of this is a higher thermodynamic efficiency (approximately 46% higher), but to date no rotating machine

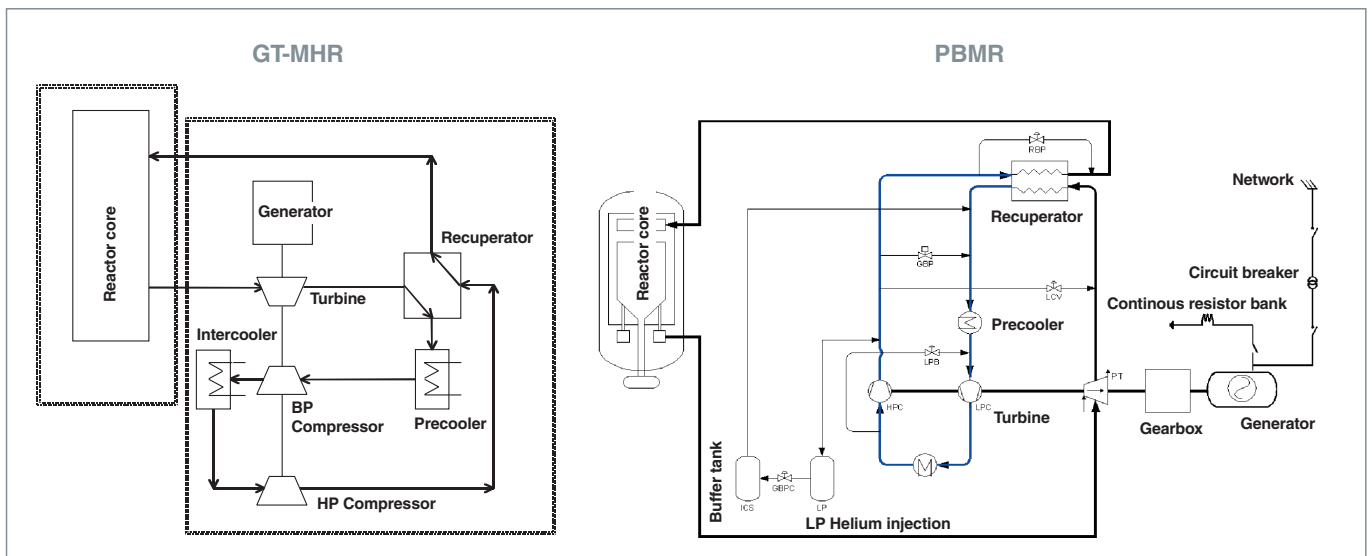

Fig. 28. Comparison of GT-MHR and PBMR energy production circuits.

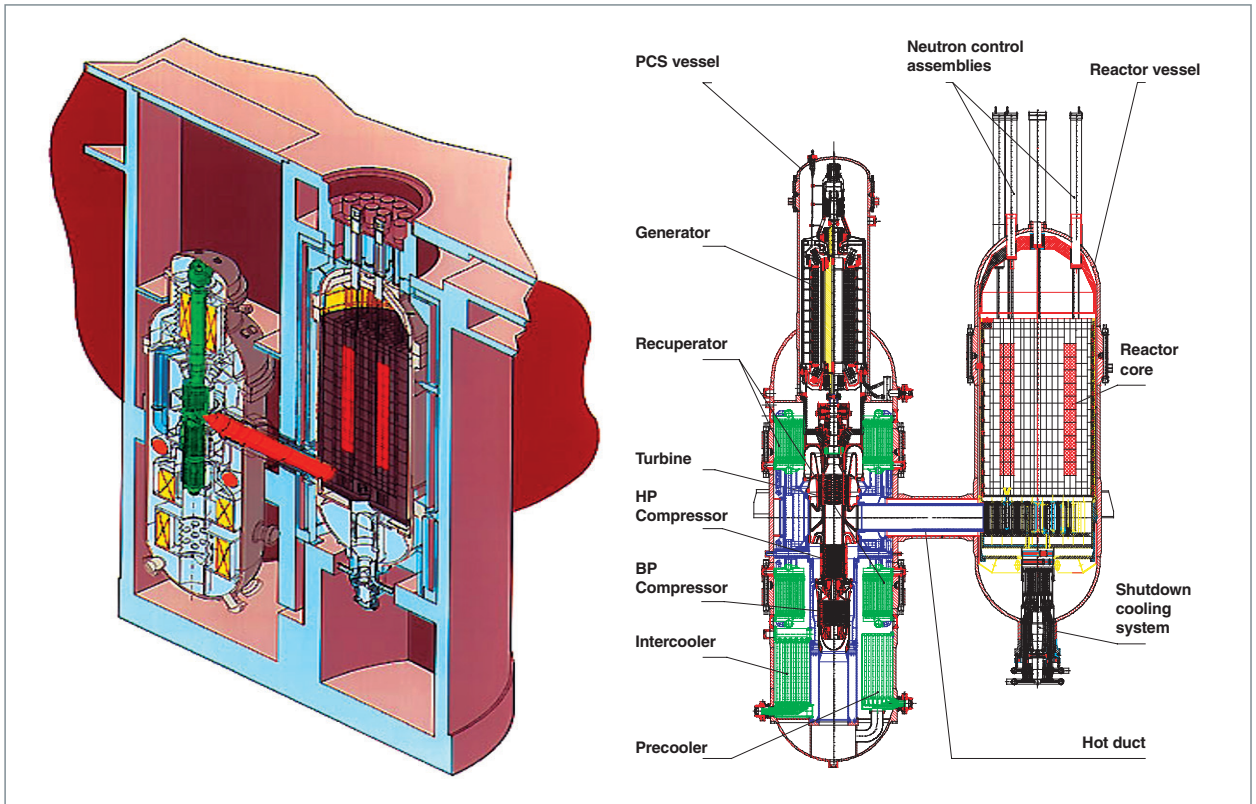

Fig. 29. General Atomics GT-MHR project (USA).

of this weight has been controlled by electromagnetic bearings, and the possibility of load recovery by a static bearing in case of malfunction remains to be demonstrated.

Generally speaking, the PBMR privileges existing technological solutions requiring no R&D, but at the cost of more complex engineering and limited performance (the use of a direct cycle provides no gain in efficiency as compared to first-generation HTRs). However, the feasibility of the GT-MHR is not fully guaranteed. The feasibility and performance of certain equipment such as the compressor-turbine-generator assembly can only really be demonstrated by building the first prototype.

These two projects are currently sufficiently advanced to begin construction.

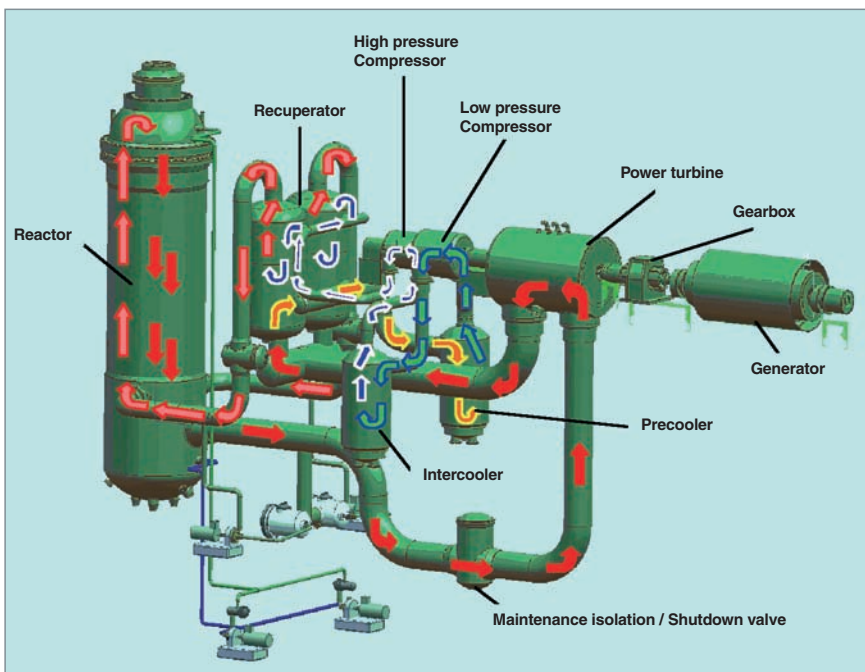

Fig. 30. ESKOM PBMR project (South Africa), in 2004.

Conclusion

The current interest in HTRs is reflected by the implementation of various projects at the international level.

These reactors exhibit significant potential: intrinsic characteristics favoring safety, electrical and heat generation applications, possibility of cogeneration, good plutonium consumption capability, etc.

Faced with **LWRs*** already well established, highly optimised through significant operating experience and benefiting from series effects, what are the chances of developing HTRs? HTRs are still far from representing an asymptotic technology. Future technical developments regarding materials, fuel particle coatings and high thermal efficiency cycles should further improve their performance.

However, despite all their advantages, it may be difficult for HTRs to develop in direct competition with LWRs. A niche market is more likely to allow their initial industrial implementation. HTRs are interesting for achieving low unit powers with a moderate investment. The passive safety of the reactor may con-

stitute an economic advantage for low-power units (due to saving on engineered safeguard systems). The possibilities offered by HTRs in terms of non-electrogenous applications of nuclear energy (desalination, hydrogen production, industrial heat) also favor their chances of industrial implementation.

The CEA and Framatome-ANP are actively involved in current developments, namely within a European framework. They consider that the most advanced HTR designs have interesting technical and economic characteristics. The major design options for current projects have been identified: helium coolant, particle fuel, modular reactors with steel pressure vessels, passive safety, direct cycle, and gas turbines. Significant engineering and development work remains to be completed in order to confirm and optimise concepts, choose the best options and reduce development uncertainties.

Bernard BONIN,

Scientific Directorate

Alain VALLÉE,

Saclay Nuclear Activities Directorate

Particle fuel

Nuclear fuels must meet a number of precise criteria in order to guarantee operation of a reactor in its optimum state (operating flexibility and availability), good management of the fuel cycle (full exploitation of the fissile material), and the safety of the nuclear plant (containment of fission products). A mix of different materials is usually used in order to satisfy all of these criteria as fully as possible. When a high density of fissile atoms in the fuel element is not required, **fissile isotopes*** of uranium 235 or plutonium 239 and 241 may be diluted in a matrix which is inert from a nuclear point of view, *i.e.* with small **cross sections*** for the absorption of neutrons and a very low level of activation.

The advantage of this type of fuel is that the thermal conductivity and irradiation response of the composite material is essentially determined by the inert matrix. With a careful choice of matrix, it is possible to achieve a good behavior of the fuel in the reactor while maintaining reasonable values for the temperature gradients and coefficients of diffusion of the fission products in the reactor core.

There are three possible solutions (Fig. 31):

- The fissile actinide is diluted in the matrix in the form of a solid solution, *i.e.* the actinide forms an integral and relatively homogeneous part of the crystalline lattice of the matrix: This is a single-phase fuel material;
- The fissile actinide is in the form of a compound finely and homogeneously dispersed throughout the inert matrix. This is a two-phase fuel material. This fuel is said to be “micro-dispersed”;
- In the third solution, the fissile actinide is contained within a compound (oxide, nitride or carbide) macroscopically and uniformly distributed throughout the inert matrix in the form of particles. This fuel is known as “macro-dispersed” or “macro-mass” fuel.



Fig. 31. The various morphologies of inert matrix fuels.

The first solution (single-phase fuel) is already in widespread use as the majority of fuels do not consist of 100% fissile metals, but rather as compounds in which the atomic concentration of fissile isotopes lies between 0.25 and 25 at.% (*e.g.* UOX and MOX ($U_{1-y}Pu_yO_2$)). These compounds of the form AnO_2 (where An represents the actinide) in which the solid solution consists of cubic oxides have relatively low thermal conductivities of around 2 W/m.K at 1,000 °C. They are, however, highly resistant to irradiation. Nitrides and carbides are better conductors of heat but they have never been used on a large scale [1].

The second version (micro-dispersed fuel) was developed during research into the transmutation of actinides. The disadvantage of these fuels is that the fuel throughout the element is damaged uniformly during irradiation, and this can result in the rapid total degradation of the material [2].

The third option (macro-dispersed fuel) was developed during the 1960s for high temperature gas-cooled reactors. HTR fuel is a macromass fuel, *i.e.* it consists of particles of the fissile isotope (spheres of between 200 and 800 μm in diameter) dispersed throughout an inert carbon-based binder (Fig. 32). The particles are composites, designed to retain the fission products.

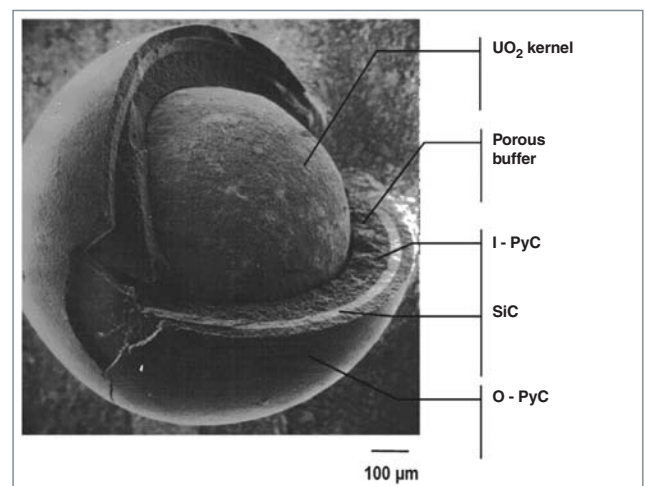

Fig. 32. Section through a particle of TRISO HTR fuel.

This fuel design is of particular interest as it combines a number of beneficial characteristics: The macro-dispersion of the particles gives the designer the freedom to vary the density of the fissile material and the proportion of moderator within the core of the reactor. This provides a high degree of flexibility in the reactor neutronics, especially in the control of the neutron spectrum. There are, however, limits on this flexibility as the spherical form of the particles limits the density of fissile material and this places a limit on the power density of the core. The spherical geometry of the fuel particles makes them mechanically robust. Careful allocation of the various concentric layers surrounding the kernel confers a high degree of resistance to irradiation and a high level of retention of fission products. The fuel contains no metals enabling it to withstand high temperatures without the risk of a core meltdown. Macro-dispersed fuel has a high surface area in contact with the carbon matrix, limiting the temperature rise within the kernel.

Taken together, these characteristics enable a high **burn-up rate*** and make particulate fuel particularly suitable for use in high-temperature reactors.

Morphology of the fuel particles

The kernel

The kernel of the particle containing the fissile isotopes (U or Pu) or fertile isotopes (Th or U) consists of a sphere of actinide oxides AnO_2 crystallized in a cubic fluoride type lattice. The spheres have diameters between 200 and 800 μm , and a density between 80 and 100 % of the theoretical density depending on the manufacturing procedure used. The oxide form was used as the behavior of these compounds under irradiation is very well understood: UO_2 is used in France, Germany, Japan, Russia and China, mixed oxide $(U_{1-y}Th_y)O_{2+x}$ is used in France, Great Britain and the USA, and PuO_2 is used in Russia. Composites containing UO_2/UC , UC_2 or even $(U_{1-y}Th_y)C_2$ are also in use in France, Great Britain and the USA in order to achieve better thermal conductivities of around 20 W/m.K at 1,000 °C.

The coating

The original feature of particulate fuels compared with traditional fuels is that the kernels are covered with a coating intended to prevent the release of fission products. Such a coating requires an impenetrable outer containment barrier surrounding an inner buffer layer in which the fission products are held. The difficulty is to develop a design that maintains its reliability under irradiation and large variations in temperature. A number of different types of coating have been developed, including the two-layer BISO particle for fertile isotopes and the TRISO particle for fissile isotopes.

The containment barrier consists of a layer of dense silicon carbide. This layer is sandwiched between two layers of dense pyrolytic carbon in the case of fissile particles, or surrounded by a single layer of pyrolytic carbon in the case of fertile particles. Each layer is around 40 μm thick.

The buffer layer holding the fission products (especially gasses) consists of a thicker layer of porous pyrocarbon deposited directly on the kernel by CVD. The thickness of this layer is around 100 μm and its density is 50 % of the theoretical value. This first layer, also known as the “**buffer**”, also limits damage to the kernel due to irradiation. Most damage to the fuel material is caused by irradiation with fission fragments. These have an average free path of 10 μm in the UO_2 core and around 20 μm in the porous graphite buffer. The kernel and buffer are therefore the only layers subjected to this type of irradiation. The porous structure of the buffer enables it to absorb this irradiation damage without the containment barrier and fuel element being affected. These only need to withstand neutron irradiation which is less severe.

The dense **pyrocarbon*** forming the final outer layer of the particle plays an important role in determining the mechanical properties of the entire particle. This layer becomes more dense under irradiation and compresses the SiC, reducing the stresses due to a build-up of fission gasses in the inner layers.

The binder

The particles are finally incorporated homogeneously in a carbon-based binder to form a cylindrical (prism) or spherical (pebble) fuel element.

Irradiation tests on particulate fuels have been carried out in the SILOE, Osiris, Pegase and Rapsodie reactors in France, the Dragon in Great Britain, the AVR in Germany, and in the Fort Saint-Vrain reactor in the USA. These tests have confirmed the excellent behavior under irradiation and the capability to retain fission products at burn-up rates of up to 75 % (**FIMA***) and at temperatures of between 1,000 °C and 1,400 °C. The thermo-mechanical behavior has also been satisfactory with very little cracking of the kernel coating layers [3].

Current R&D relating to the manufacture of particulate fuels

The only countries active in the development of HTRs in the 1990s were Japan and China with the manufacture and irradiation of particulate fuels and the commissioning of the low-power JAERI reactor in O'Arai, Japan.

Research into manufacturing has restarted with the launch of the Generation IV Forum, including a Very High-Temperature Reactor (VHTR) program as a precursor for Gas-cooled Fast Reactors (GFR). In France, however, the knowledge and experience gained by the CEA (Grenoble and Saclay) and certain manufacturers (CERCA) in the 1970s has largely been lost, and new pilot plants have been required in order to provide for an eventual manufacturing capability

This R&D activity has been relaunched with an experimental program and numerical simulation studies. The simulation of uranium oxide by stabilized cubic zirconia has been used at CEA Grenoble to develop a process for manufacturing particles with TRISO coatings applied by CVD.

A new production line named GAIA is currently being installed in partnership with AREVA at Cadarache for the manufacture of particle fuels with UO_2 kernels [4]. This plant will produce up to 1 kg of uranium oxide kernels in each production cycle using a sol-gel process. The plant will also produce fuel elements. The furnaces within the GAIA plant will also be capable of manufacturing both SiC and the more advanced ZrC

coatings. The ZrC coatings have a potentially higher performance enabling the fuel to be used at higher temperatures.

The current reference process for the manufacture of fuel kernels is a sol-gel process. In this process a mixture of actinide nitrate and a soluble organic polymer is gellified by dropping the droplets of the mixture into ammonium hydroxide. These gel droplets then act as a support for the precipitation of the actinides. The spherical shape of the droplets is maintained as the spheres are washed and dried. They are then transformed into actinide kernels by calcination at high temperature.

The results of initial tests using the GAIA facility have been used to refine certain important parameters in the Kernel manufacturing process.

- The formation of droplets is affected by the vibration frequency, the feed rate and viscosity of the mixture, and the diameter of the nozzle.
- The sphericity of the kernels depends on the concentrations of U and NH_4OH , and on the types of polymer and additives used.
- The densification of the UO_2 kernels is determined by the atmosphere, the temperature and the rate of change of temperature.

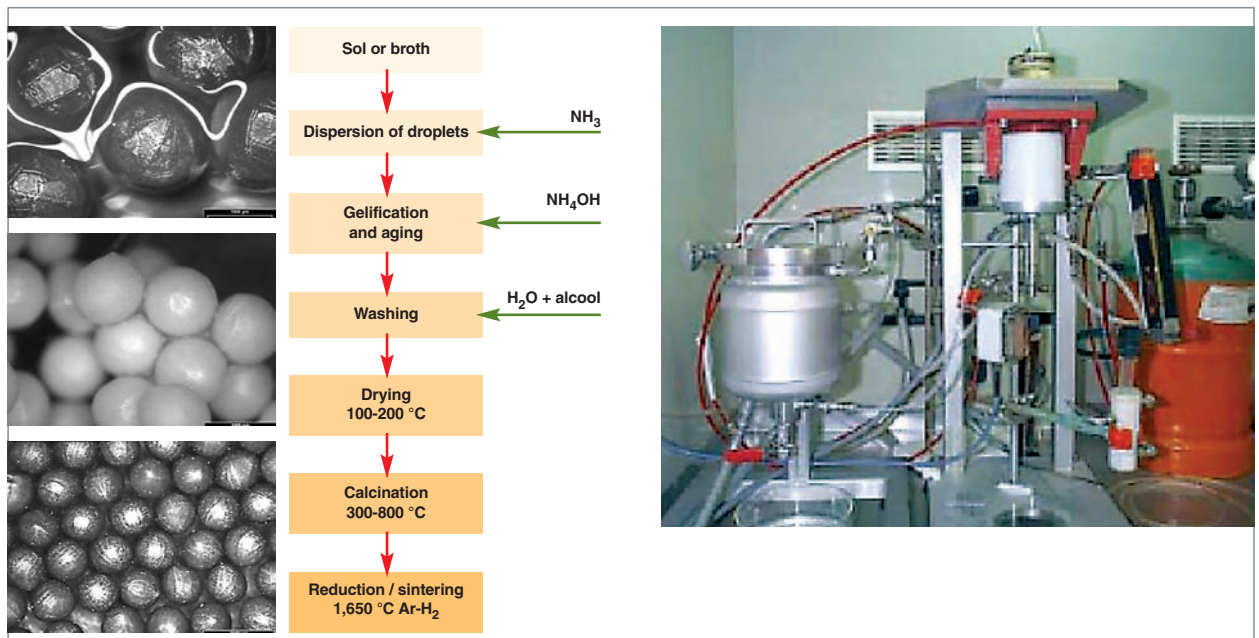

Fig. 33. The sol-gel process for the manufacture of kernels as used in the CEA GAIA facility.



Fig. 34. The operating principle of the CVD coating process, the CEA furnace, and initial results for the coated particles.

The coating layers are then applied by chemical deposition by the decomposition of a precursor gas in a fluidized bed that keeps the particles in suspension during the reaction (see Fig. 34). The dense and porous pyrocarbon layers are deposited by cracking propylene and acetylene respectively at 1,300 °C. The SiC layer is deposited using Methyl-Trichloro-Silane (MTS: CH_3SiCl_3) with the addition of hydrogen. The layer of SiC obtained is mainly cubic in structure, but not single phase (cubic SiC + hexagonal SiC + Si) [5].

The behavior of the TRISO particles described above is highly dependent on the quality of their manufacture. It is particularly important to control the diameter, sphericity and density of the fuel kernels. The important factors affecting the coatings are the thickness and density of the layers, and the anisotropy of the pyrocarbon layers. The entire process requires an understanding of the relationships between the parameters of the manufacturing process, the micro-structures obtained, and the behavior under irradiation.

The future for particle fuels

Current particle fuels of the TRISO type are perfectly suitable for use in an HTR, and this design will certainly be retained for any HTRs built in the medium to long term. Current research is aimed at extending the boundaries of this design even further in order to enable use at very high temperatures (see the Section relating to the VHTR, *infra*, p. 71-108), or with fast neutron spectra (see Section relating to the Gas-cooled Fast Neutron Reactor, *infra*, p. 109-156).

► References

- [1] H. BAILLY (*et al.*), *Le combustible nucléaire des réacteurs à eau sous pression et des réacteurs à neutrons rapides*, Eyrolles, Paris, 1996.
- [2] C. CHAUVIN (*et al.*), *J.Nucl. Mat.*, 274, [1-2], 105, 1999.
- [3] C. MOREAU (*et al.*), *AIEA Symposium*, CN 36/270, 1977.
- [4] F. CHAROLLAIS (*et al.*), *Conférence Atalante 2004*, Nîmes, 2004.
- [5] C. MOREAU, *Techniques de l'ingénieur*, coll. "Génie nucléaire", vol. BN3, n° B3640, 1983.

Michel BEAUVY

Fuel Research Department

HTR neutronics

Physical and neutronic characteristics of High-Temperature Reactors

The neutronic behavior of very high temperature gas-cooled reactors is very specific, mainly due to the use of particle fuel and a graphite moderator. Contrary to water-cooled reactors, in which water acts as both coolant and moderator, the helium coolant used in HTRs plays practically no role in the neutron moderation process. This separation of functions gives designers great freedom in the choice of neutronic characteristics for HTRs.

The relatively high atomic weight of carbon makes graphite a mediocre moderator. Fission neutrons must undergo a large number of elastic scattering events before reaching the thermal energy range (120 collisions on average, as compared to the 18 required for a hydrogen moderator). This results in a high number of neutrons in the **epithermal*** range (a few eV to a few tens of keV), as compared to other reactor series, with a high probability of absorption in heavy nuclei **resonances*** during the slowdown phase. Figure 35 shows the neutron energy distributions for several types of reactors. The second curve (non-carbon matrix particles) does not correspond to a specific reactor series, but it enables us to quantify the impact of the graphite moderator. Particles deprived of the surrounding graphite matrix and bathed directly by the gas have their neutron spectrum shifted toward the high-energy side. Nevertheless, the graphite has a very low neutron absorption cross-section (~ 3 mbarn*, two orders of magnitude less than that of hydrogen), which improves the reactor **neutron balance*** (less sterile captures) and makes the graphite better than water in terms of moderator/absorption tradeoff. Moreover, due to the very low absorption coefficient of natural graphite and the large quantities of it present in HTRs, impurities play an important role in the absorption of neutrons by the graphite. It is therefore essential that the level of impurities produced during fabrication of the graphite be taken into account in the neutronic calculations.

The use of highly **fragmented fuel** also favors neutron absorption in heavy nuclei resonances. With conventional plate or rod fuel elements, a portion of the absorbent heavy nuclei, particularly uranium 238, is transparent to neutrons, which are preferentially captured in the fuel periphery. In HTRs, the micro-grain fuel elements increase the capture probability.

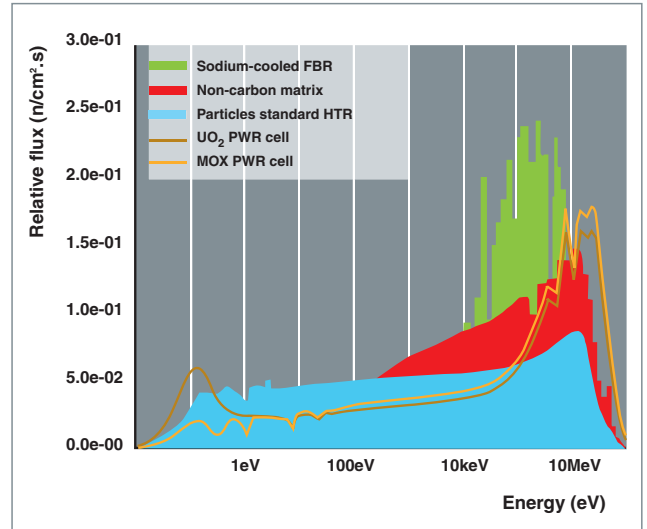

Fig. 35. Neutron spectrum* for different reactor types.

Since **helium is transparent** to neutrons, the use of a graphite matrix containing fuel microparticles leads to the following characteristics:

- HTRs have a **moderation ratio*** of 500 to 1,000 carbon atoms per heavy nucleus. This results in large moderator volumes, and therefore large **cores***.
- HTRs have a high heavy nuclei conversion rate, due to the high neutron capture rate in the fuel. For example, core configurations using fertile matter (Th 232-U 233 cycle) with conversion factors close to 1 (iso-generation of fissile material) have been studied.
- HTRs have a high uranium 235 enrichment requirement, due to the high neutron absorption of uranium 238. This requirement is also necessary to fully benefit from the high burn-up performance of the fuel particles and thereby compensate for the disappearance of fissile material through fission.
- HTRs are characterized by an important neutron **migration area***, corresponding to the sum of the square of the distances effectively covered by neutrons prior to absorption, during slowdown, and during thermal diffusion. The slowdown distance on HTR graphite moderators is very large, and the large migration area resulting from this (450 cm^2 , as

compared to 50 cm² in a PWR) leads to significant neutron leaks. For example, 10% of neutrons exit the annular core of a GT-MHR without being absorbed. These leaks give the reflectors an important role as regards the core neutronic behavior. In particular, the reflectors have a non-negligible positive temperature coefficient, making it necessary to take the associated temperature feedback effects into account (in addition to core temperature feedback effects). For a given moderating ratio, the migration area in a pebble-bed core is at least two times larger than in a prismatic core, due to the greater particle dispersion in the graphite volume.

Resulting modeling difficulties

Fuel particles constitute the first modeling difficulty, as they are randomly distributed in the graphite matrix of the fuel compact or pebble. This stochastic geometry requires the formulation of a fuel particle distribution hypothesis in the core modeling and somewhat questions the absolute reference image derived from **Monte Carlo*** type probabilistic algorithms. This is all the more problematic as there is currently very little experimental data available to qualify the calculation tools. It must be noted that pebble-bed HTRs exhibit the random geometry problem at two levels: microparticle distribution in the pebbles, and pebble distribution in the reactor cavity. This problem has been studied at the CEA only on the basis of Monte Carlo simulations using the TRIPOLI4 code [1] (Fig. 37). A comparison with feedback from the Chinese HTR-10 tests reactor has shown that results are very sensitive to the in-core pebble distribution hypothesis adopted. On the other hand, the type of modeling adopted to represent the random distribution of the particles in the fuel sphere has been shown to have little impact (less than 100 pcm*).

The highly fragmented nature of the fuel reduces the volume of heavy nuclei transparent to neutrons, making it possible to achieve very high burn-up fractions that seem to be confirmed

by the particle technology. This attractive characteristic poses the challenge of controlling the evolution of **reactivity*** and predicting the fuel composition after long irradiation periods. Uncertainties regarding cross sections, the propagation of such uncertainties in calculations of changes in composition during the irradiation cycle, and the impact of absorption by fission products on the neutron balance are criteria that must be carefully considered for these fuels, characterized by the destruction of up to 70% of the heavy nuclei initially present. The continuous refueling process of the pebble-bed fuel further imposes simultaneous calculations of burn-up and fuel pebble rearrangement for each irradiation flux step in order to estimate the core reactivity over time.

The association of the graphite and highly fragmented fuel maximizes neutron absorption in heavy nuclei resonances. This makes the choice of hypotheses for resonant cross sections particularly difficult (**self-shielding*** calculations). The imperfections of self-shielding models, leading to uncertainties currently controlled in PWR calculations, may be amplified in the case of HTRs.

In addition, the choice of helium as coolant leads to large gas flow cross-sections in the core. These gas channels constitute preferential leak paths (**streaming***) for neutrons whose orientation is close to that of the gas flow, since helium is transparent to them. The processing of these leaks in the core calculations is one of the key problems in HTR modeling, namely for the gas channel regions where the control rods are located. On the other hand, there is no reactivity effect due to in-core coolant drainage.

Contrary to PWRs, the separation of parameters used to determine the cooling geometry (core porosity) from those allowing optimal neutron moderation (carbon ratio in heavy nuclei) gives HTRs a wide flexibility of fuel usage (adjustment of particle type and size, volume occupation ratio, presence of consumable poisons, etc.). To benefit from this flexibility, it is possible to design complex and strongly heterogeneous core configurations. Moreover, certain HTR concepts must ensure a passive evacuation of residual power, leading to the implementation of annular cores. Annular configurations produce important spatial variations of the neutron spectrum, and therefore core-reflector interfaces that are more difficult to model. In addition to these 3D heterogeneous annular core configurations, the presence of control rods and temperature feedback effects in the reflectors must also be taken into account. Figure 37 shows the multi-scale modeling difficulties with the prismatic block annular core reactor.

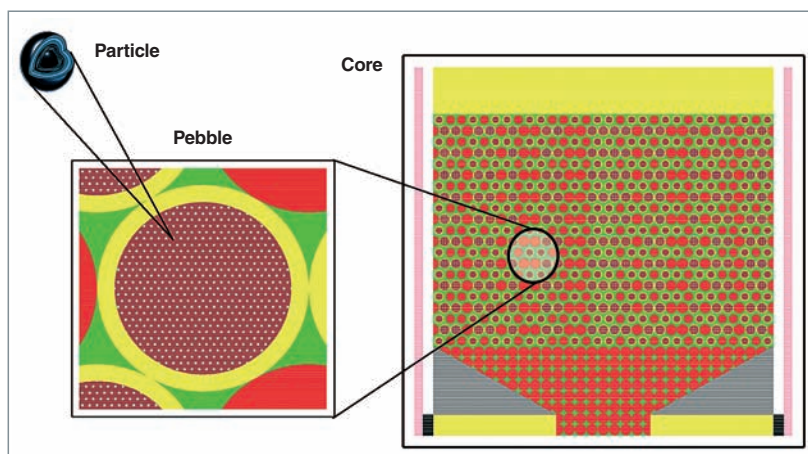

Fig. 36. Calculation geometry for the Chinese HTR-10 test reactor.

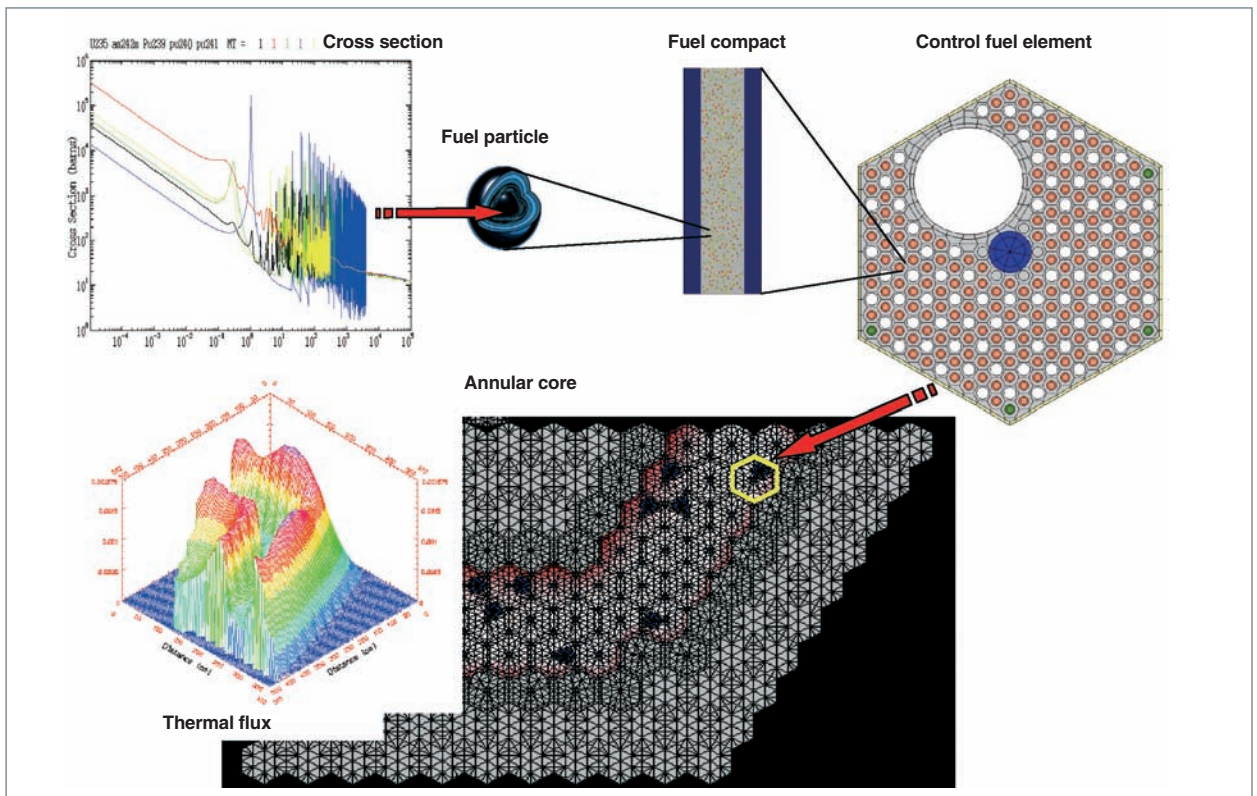

Fig. 37. Modeling of prismatic block HTR cores.

These various difficulties make the modeling of HTR core physics a true challenge. Calculation tools and methods have been developed in the past. Unfortunately, these methods have been partly validated and qualified on fuels and core configurations different from those considered today (Th fuel, highly enriched uranium, little validation under temperature and core operating conditions).

A calculation scheme has been recently developed at the CEA based on the SAPHYR system implemented for PWRs, combined with the CASTEM code for temperature feedback effects. AREVA will be able to use this calculation scheme for its HTR design studies [2]. Core-level validation is first ensured through intercomparison exercises (calculations by different teams for the same core, and comparison with Monte Carlo type reference calculations). Calculation/experience comparisons are currently possible with the Japanese HTTR test reactor (prismatic core) and Chinese HTR-10 test reactor (pebble-bed core), which went critical in 1998 and 2001, respectively. However, these comparisons do not concern calculations of changes in core composition according to irradiation or calculations taking into account temperature feedback effects.

In particular, the intercomparison of HTTR startup calculations (Fig. 38) integrates all the modeling difficulties of this type of core. It has enabled an assessment of the capacities of the SAPHYR system to model a compact, strongly heterogeneous HTR core (consumable poisons, different enrichments) in annular configuration with control rods in the reflector and important streaming effects.

HTTR example

The HTTR first criticality analysis has been proposed as a calculation intercomparison exercise by an IAEA workgroup. The initial calculations performed in various countries all overestimated the core reactivity and presented highly dispersed results (10 to 17 fuel columns predicted as required to go critical, as opposed to 19 in reality [3]), clearly illustrating the modeling difficulties for HTRs regardless of the method employed, whether deterministic (transport and diffusion theory) or probabilistic (using the Monte Carlo code).

After adjusting the experimental data (impurity content in the graphite, first criticality in air, not helium), the participants in the exercise analyzed their deviations and models. This time-consuming work, supported by the European Community, yielded a second series of results showing significant progress [4]. The calculations presented in Figure 39 show the impact

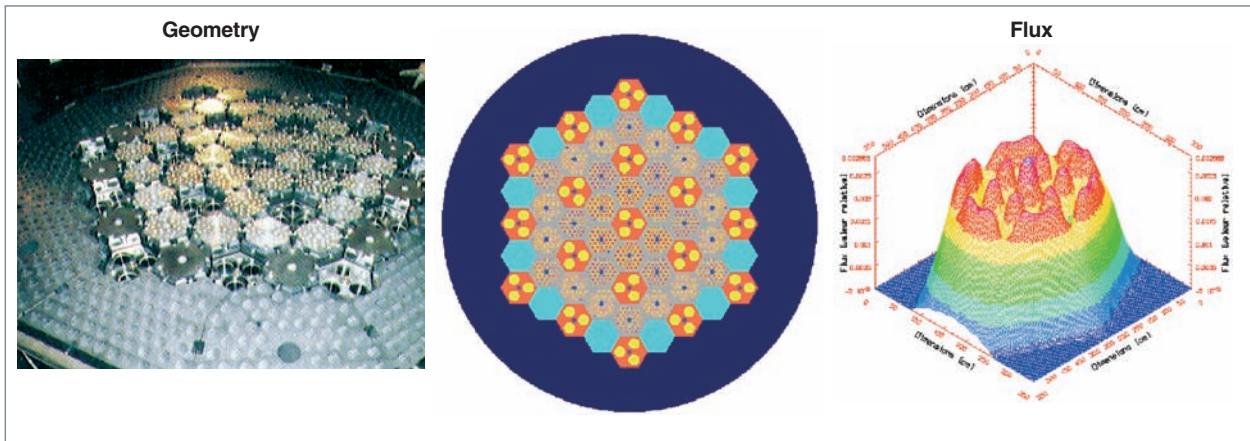

Fig. 38. HTTR calculation geometry and thermal flux. The center image shows the fuel elements containing the fuel compacts (which contain the particles). The control elements present in the core and reflector are also shown.

of the refined modeling (taking into account of heterogeneities, streaming, etc.) on the prediction of the number of columns required for first criticality.

The general conclusions indicate a good agreement between the results obtained from deterministic calculations, probabilistic calculations and experience, for the full core configuration (30 columns). On the other hand, deviations are observed for intermediate configurations (e.g., 24 columns). The calculation results for the annular configuration (18 columns) close to first criticality continue to overestimate reactivity as compared to experience, but to a lesser extent. At best, the Monte Carlo codes predict core **criticality*** with 18 columns (i.e., with approximately 600 to 800 pcm of excess reactivity). The hypotheses formulated to explain these deviations are the following: **experimental uncertainties** (impurities, reactivity measurements, etc.), modeling of the random geometry (particles in fuel compacts) and general accuracy of cross sections.

The 3D neutron diffusion calculations performed for an annular core configuration also show a deviation of approximately 900 pcm with respect to the Monte Carlo calculations and clearly illustrate the limitations of applying a two-step deterministic scheme based on fuel transport and core diffusion calculations. However, the difficulties encountered with this annular HTTR core configuration are not directly transposable to other reactors of this type (GT-MHR, PBMR, etc.). In particular, the startup annular core, strongly heterogeneous,

of low thickness and comprising a central reflector with a large number of “pierced” elements maximizing the streaming effect (Fig. 40), is not representative of a power reactor. The HTTR remains a reference in terms of modeling difficulties.

Similar studies on the distribution of fuel pebbles in the PBMR core have shown that the use of ordered structures should be considered with precaution. The observance of both the void fraction and the respective proportions of the various types of pebbles (fuel, graphite, consumable poison, etc.) makes this approach very complex. It may generate preferential neutron leak channels (gas columns between the fuel spheres), and it does not make it possible to take into account a replenishment rate gradient near the reflector.

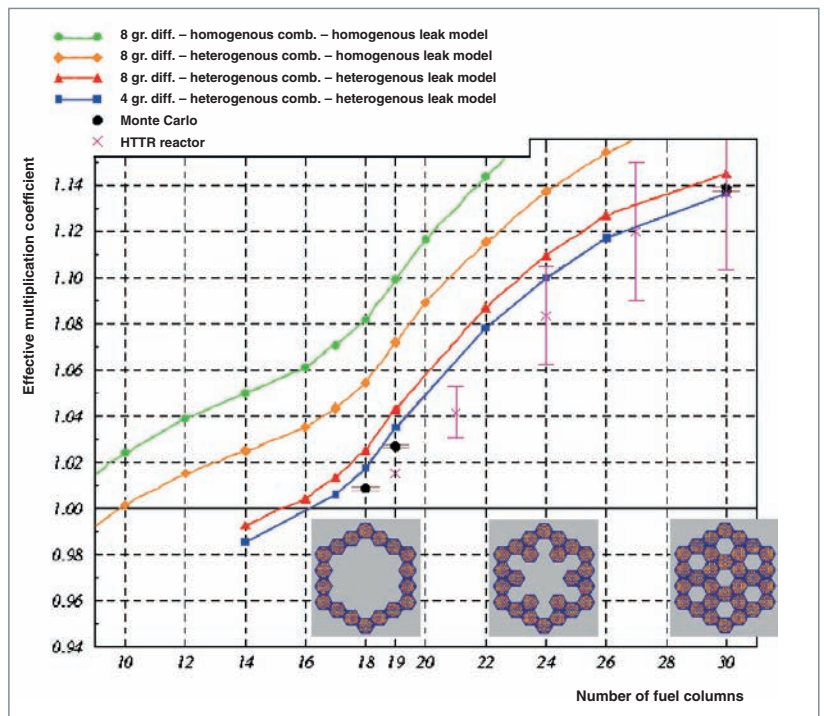

Fig. 39. HTTR reactivity according to number of fuel elements.

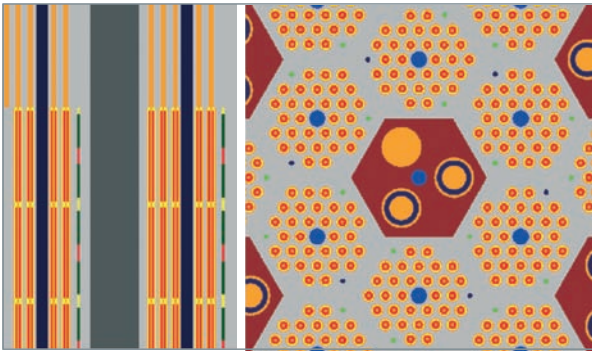

Fig. 40. Axial and radial details of HTR heterogeneities. Each fuel element contains annular fuel compacts (red) comprising the fuel particles, two consumable poisons (green) and an unused position (blue). The control element comprises three channels to receive two annular B_4C rods.

The recent interpretation of the ASTRA experiment with the TRIPOLI4 code clearly shows a strong dependence of the position of the absorbent pebbles in the core, resulting in reactivity deviations largely exceeding the statistical uncertainties of the Monte Carlo model itself (Fig. 42).

Faced with stochastic geometries, there is no longer a reference calculation representative of the core. Even with a numerically perfect neutronic calculation, each specific representation of the core geometry will yield a different reactivity result. The reactivity range associated with all possible representations of the random geometry is intrinsic to the core design and not dependant on calculation refinement. How can this reactivity and its associated uncertainty be estimated? The Monte Carlo simulation is certainly a promising tool for core physics, but the best way to use it to describe HTR fuel and core geometries still remains to be identified. It will undoubtedly result from a tradeoff between the facility to enter these geometries in Monte Carlo codes (associated with reasonable calculation times) and the generation of acceptable results (with controlled uncertainty and in agreement with validation tests).

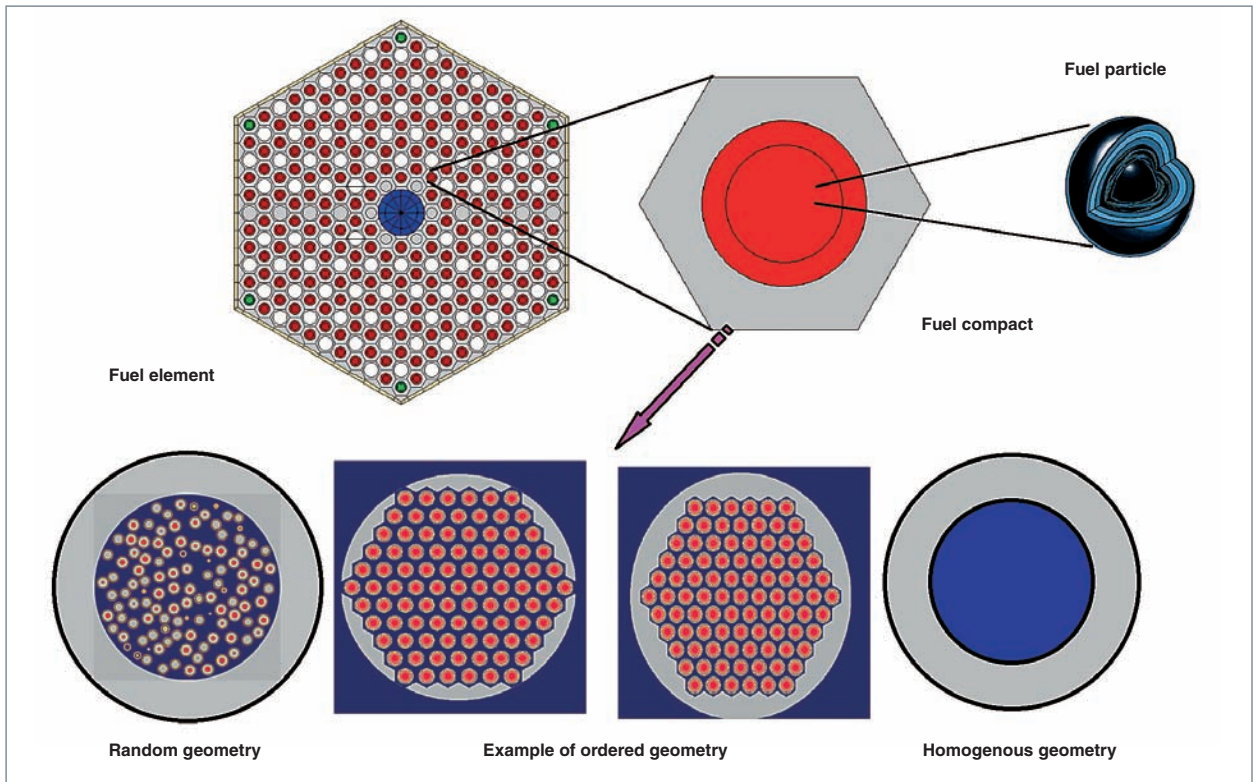

Fig. 41. Example of applications of the TRIPOLI4 code to model HTR particle fuels. Various representations of the random medium have been tested: random distribution, reduced or non-reduced hexagonal structure, cubic structure, homogeneous medium (based on cross sections calculated by APOLLO2). As a general rule, the random distribution of materials in the core should have no impact on the neutronic calculation results if the characteristic size of the

heterogeneities is small in comparison with all the mean free paths (diffusion, fission, capture), which is generally the case at the fuel particle scale. On the contrary, an impact is to be expected if the characteristic size of the heterogeneities becomes comparable to one of the mean free paths (this is the case at the HTR fuel pebble or fuel compact scale).

Applied to reactor core neutronics, the Monte Carlo method is the only method enabling the general resolution of the Boltzmann equation. This calculation takes into account the random character of neutron trajectories in the reactor core by applying the probability laws of the various random variables (shocks, mean free path, etc.) and simulating a very large number of neutron histories. In the case of HTRs, characterized by disperse fuel elements, the Monte Carlo calculation must also take into account the random character of the core material distribution (Fig. 41).

The two stochastic levels mentioned above are of different natures and must therefore be treated differently. For a known, fixed core geometry, the core reactivity is perfectly defined. The random character of the neutron histories generates a statistical uncertainty regarding the core reactivity, but this uncertainty can be theoretically reduced to levels as low as necessary by increasing the number of neutron histories. The random character of the neutron trajectories does not reflect a physical reality, since a very large number of neutrons are actually diffused simultaneously in the core. On the other hand, the random character of the core geometry does reflect a physical reality, since this geometry is only subject to one occurrence at a time. The range of reactivities generated by all possible geometries is a calculation result characterizing the core. The width of this range does not depend on the refinement of the calculation and cannot be reduced to a statistical uncertainty. This uncertainty regarding the detailed core geometry is a real physical uncertainty that introduces an uncertainty in the prediction of reactivity. It is therefore essential to quantify it.

Various possibilities for the numerical processing of HTR stochastic geometries are currently available with Monte Carlo codes:

- **Explicit representation of the random geometry, *i.e.*:**

1. Using ordered structures (cubic with centered faces, hexagonal, etc.) to describe the spatial position of the fuel spheres.
2. Using a random geometry generator (involving the repetition of a large number of simulations), either external or internal to the code. For example, the American MCNP code proposes deformations of the ordered structure (in the case of a cubic structure, a random position is assigned to the fuel sphere in its elementary cube).

- **Statistical description, *i.e.*,** progressive construction of the geometry based on the neutron history monitored in a medium containing a random distribution of heterogeneities (Japanese MVP code).

- Homogeneous approach.

Whether it is used to represent fuel particles in a graphite matrix or fuel pebbles in a reactor core cavity, this last approach is too coarse to be used by simply averaging the cross sections of the various nuclei in the medium. However, an option consisting of using homogenized cross sections of the graphite matrix with its particles, previously generated by deterministic **multigroup*** transport calculations (APOLLO2 code), seems promising. This option is possible in that the measurement or description of the particle-containing media is already available in APOLLO2 and because the Monte Carlo TRIPOLI4 code can simultaneously simulate regions treated by multigroup approximation and others treated with a very fine representation of cross sections (continuous energy) in the same calculation. This approach has been confronted with feedback from the HTTR and HTR-10 test reactors, and from the PROTEUS critical facility. These TRIPOLI4 calculations have been compared with other models of ordered structures and random geometries. A good agreement has been observed between experience and the various models. The results obtained show that in most cases an ordered geometry can be representative of the random geometry of HTR fuel particles. However, it is difficult to generalize this approach for all types of possible configurations (different particle sizes, different volume occupation ratios, fuel type, enrichment, burn-up fraction, etc.), and each case would require effective confirmation.

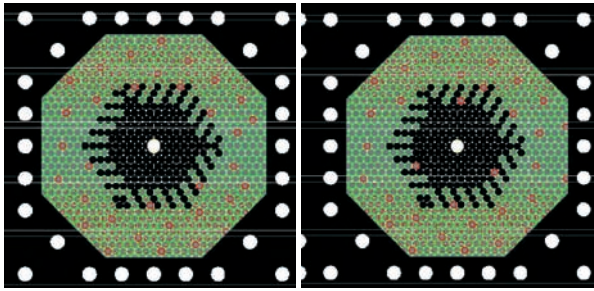

Fig. 42. Simulation of the ASTRA experiment using the TRIPOLI4 code. The core contains three types of pebbles (6 cm in diameter): uranium (gray), graphite (black) and boron carbide (red). These two representations of the random geometry lead to very significant reactivity deviations, in the order of 400 pcm, whereas the statistical uncertainty associated with the neutronic calculation of each geometry's reactivity does not exceed 30 pcm for a typical calculation involving 10 million neutrons. The variations of the thermal neutron spectrum observed by the absorbent spheres located at a greater or lesser distance from the reflector explain these deviations in reactivity. These deviations must be interpreted as intrinsic to the core design, and they truly exist in this type of pebble-bed reactor. Only Monte Carlo type calculations are capable of clearly identifying them.

► References

- [1] H. CHANG, F. DAMIAN, Y. K. LEE, X. RAEPSAET, J. XINGQING, Y. YONGWEI, – « *Treatment of Stochastic Geometry in Pebble Bed Reactor with Monte Carlo Code Tripoli-4.3* » – Conférence HTR-2004, 22-24 septembre, 2004.
- [2] L. BRAULT, F. DAMIAN, C. GARAT (FRA-anp), J.-C. KLEIN (CEA), A. MAZZOLO, C. POINOT, X. RAEPSAET, S. SANTANDREA, – « *GT-MHR Core Modelling: From Reference Modelling Definition in Monte-Carlo Code to Calculation Scheme Validation* » – Conférence PHYSOR 2004, 25-29 avril, 2004.
- [3] « *Évaluation of High Temperature Gas Cooled Reactor Performance : Benchmark Analysis Related to Initial Testing of the HTTR and THR-10* » – IAEA-TECDOC-1382.
- [4] H.J. BROCKMANN, F. DAMIAN, J.B.M. DE HASS, U.A. OHLIG, X. RAEPSAET, E.M. WALLERBOS, « *Analysis of the European Results on the HTTR's Core Physics Benchmarks* » – *Nuclear Engineering & Design*, 222 (2003), p. 173-187.

Xavier RAEPSAET

Systems and Structures Modeling Department

Modular HTR safety concept

Safety and design

In the past, HTRs were designed using conventional technology and safety concepts (thick concrete vessel containing the reactor coolant system, active auxiliary cooling and water systems, external containment for radioactive leak retention). This design, illustrated by the German HTGR-1160 reactor project shown in Figure 43, has the advantage of allowing for high reactor power, but it requires the implementation of diversified and very high-quality core cooling systems to ensure integrity in all situations, as in the current PWR design. The optimisation of this type of concept generally results in a reactor power exceeding 1,000 MWth, with a relatively important investment cost.

Another approach has been developed since the mid-1980's: modular HTRs. The idea is to design nuclear reactors whose natural behavior is sufficiently stable to avoid requiring complex active systems for the management of possible accidents. It must be noted that most of these accidents are but the result of a serious malfunction of such systems. The idea is attractive. Reactor safety demonstrations are simplified, and the amount of equipment is reduced.

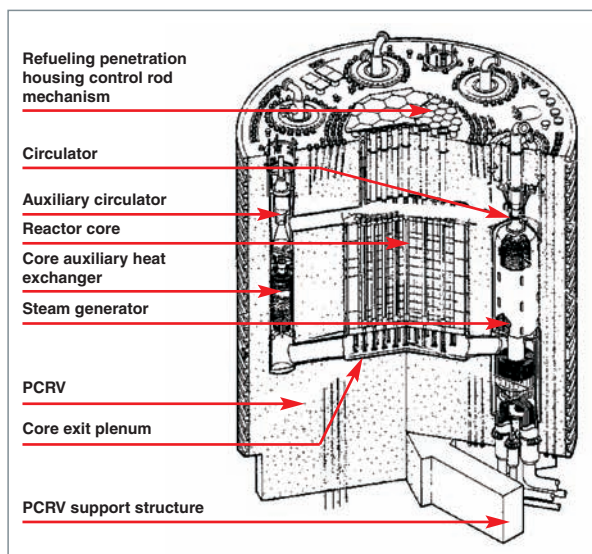

Fig. 43. German HTGR-1160 designed in the 1970's, consisting of a concrete vessel containing the active core cooling systems. The subsequent evolution of HTRs toward modular concepts with lower unit power levels and steel reactor vessels enables passive core cooling in the event of a loss-of-coolant accident.

Designing such a reactor inevitably generates constraints: reduced core power density and total core power (to simplify the cooling process), and significant thermal inertia (to smooth possible thermal fluctuations). This effectively results in low-power, high-volume reactors. For example, the 600 MWth GT-MHR comprises a metal vessel the same size as that of a 3,000 MWth PWR.

To make up for the resulting increase in cost per electric kWh, the design is supplemented with the modularity concept. According to this concept, an electrical production plant will consist of several small reactor modules, thus benefiting from cost savings in common parts, and standardized in-factory construction. The modular reactor concept allows increased simplification of the reactor circuits (e.g., Joule-Brayton thermodynamic cycle with a single turbomachine coupled to the alternator). As illustrated by the General Atomics GT-MHR⁷, modular HTRs maintain most of the HTR safety characteristics: significant thermal inertia of the core, robustness of particle fuel, and stability of neutronic behavior: The modular reactor concept provides additional safety, namely by allowing for passive evacuation of residual power.

The materials, design and operation of the main equipment for this type of reactor are defined so that the fuel particle ensures radionuclide containment under all circumstances without requiring short-term corrective actions.

The main options adopted with regard to modular HTR safety are described below. They are part of the demonstration of public protection against potential radiological consequences.

7. See Fig. 29, p. 43.

Reactivity control

The reactor is designed to have a highly negative **temperature coefficient*** in all foreseeable situations. All increases in temperature produce a decrease in power. The risk of significant reactivity insertion is therefore eliminated. In particular, the reactor is not sensitive to variations in cooling fluid density, since helium is relatively transparent to neutrons. The use of graphite ensures neutron moderation under all circumstances. These characteristics even allow for the possibility of cores exclusively containing plutonium. Potential initiators of fast and significant reactivity insertion (control rod ejection, massive inflow of water) are excluded by design. For events such as rod withdrawal accidents, limited water insertion and core overcooling, the reactor power is naturally limited by the highly negative temperature coefficient⁸.

Core heating can result in a power decrease, or even a shutdown of fission reactions in case of complete loss of cooling systems.

These characteristics reduce the importance of the reactor shutdown system, whose short-term actions are not indispensable. This system is nevertheless required to make up for the insertion of reactivity due to the **xenon effect***, and to achieve and maintain cold shutdown status.

Evacuation of residual power

The typical core power density of a modular HTR is 4 to 7 MW/m³ (as compared to over 100 MW/m³ in PWRs). The large volume of graphite gives these reactors significant thermal inertia. In case of reactor shutdown, a significant portion of the residual power can be absorbed through a moderate increase in temperature. In case of failure of the normal reactor cooling systems, residual power can be evacuated without the need for forced helium circulation, merely through conduction and radiation in the core, and radiation between the reactor vessel and a cooling circuit covering the walls of the cavity containing the vessel. This cooling circuit operates constantly and is indispensable in the long-term to limit the temperature of the vessel and concrete in the cavity. Its design is adapted to ensure a maximum level of reliability.

The significant thermal inertia of the graphite core (very high temperature resistance, with sublimation at 3,000 °C), associated with a low power density and an annular core geometry, results in very slow and limited temperature increases. In the absence of forced coolant circulation, the core heating rate is only 0.2°C/s. If the nominal helium pressure is maintained, the peak temperature is attained beyond a one-day period and its maximum value remains below 1,600 °C (Fig. 44, 45, 46 et 47).

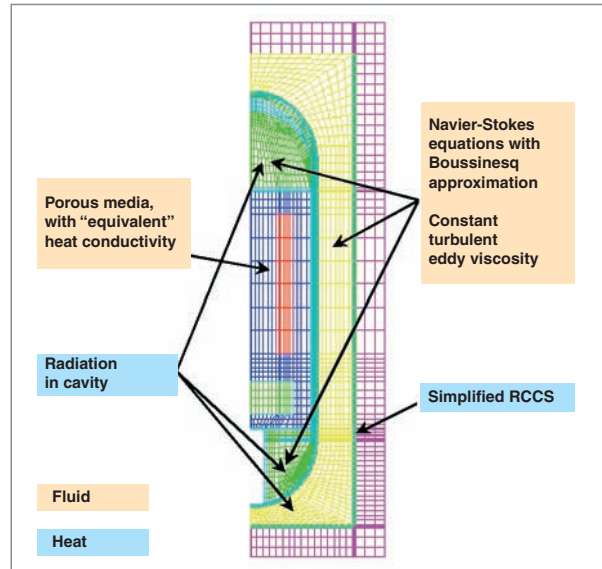

Fig. 44. Calculation of modular HTR core heating in case of failure of normal reactor cooling systems. Calculation performed using the CEA's CASTEM code. Main calculation parameters: natural convection, conduction in the core (considered as a porous medium), and radiation towards the vessel walls.

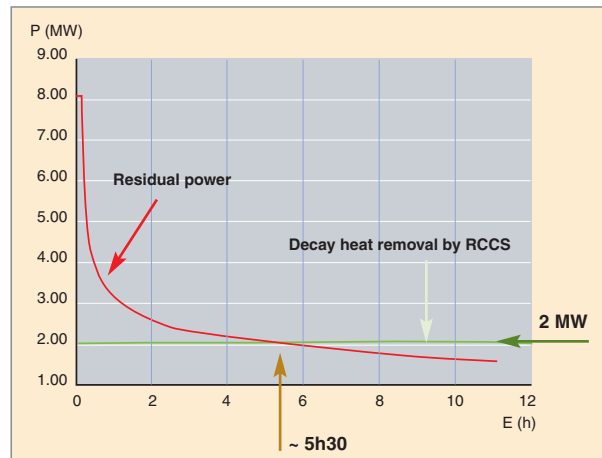

Fig. 45. Comparison of residual power released by the core and evacuated thermal power for a modular HTR in case of failure of normal reactor cooling systems. The vessel pit is capable of evacuating 2 MW through natural water circulation in concrete-embedded piping. Calculation performed using the CEA's CASTEM code.

8. The existence of a positive temperature coefficient in the reflectors imposes a few precautions.

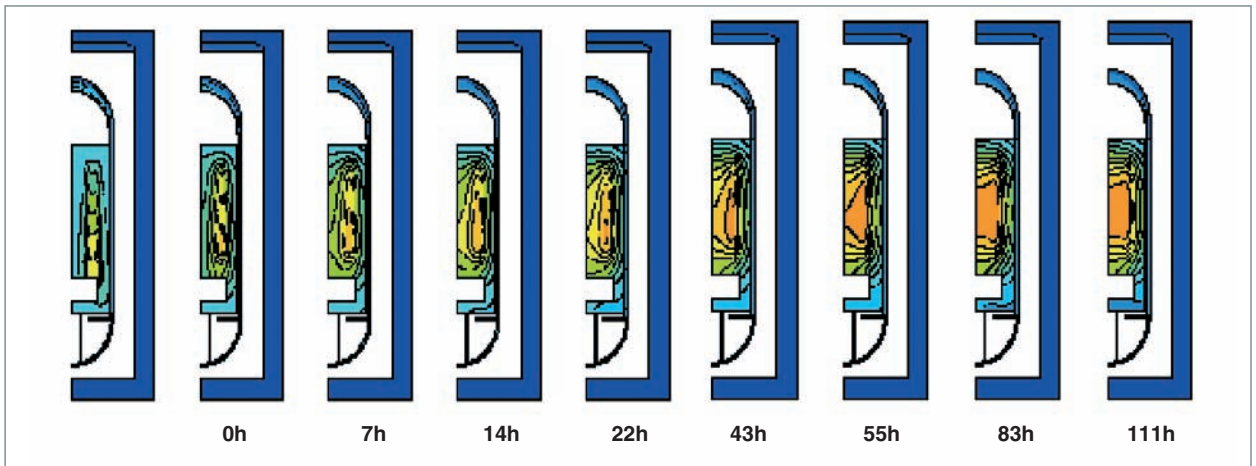

Fig. 46. Evolution of the temperature field in modular HTR core in case of failure of normal reactor cooling systems. The CEA's CASTEM code predicts temperature increases limited by the progressive transfer of heat from the fuel towards the graphite, and then towards the vessel pit.

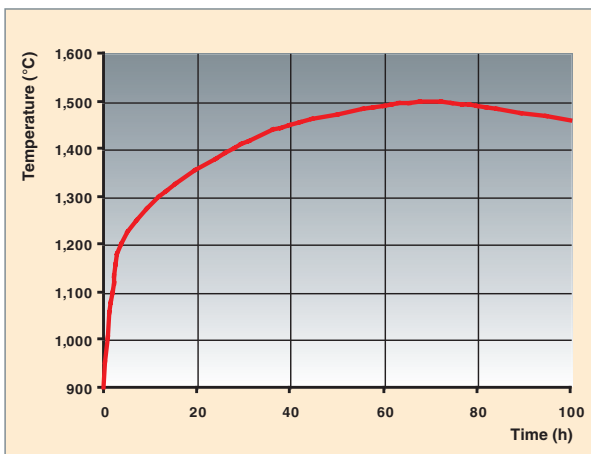

Fig. 47. Evolution of the core temperature during a residual power evacuation transient for a GT-MHR type reactor. In the absence of forced coolant circulation, the initial core heating rate is only 0.2°C/s.

Containment system

The fuel particle acts as the main radionuclide containment barrier in all possible situations.

Under accident conditions, the fuel particle maintains good performance characteristics at extremely high temperatures, possibly exceeding 1,600 °C. Beyond such temperatures, these performance characteristics decrease very progressively.

Under normal operation, the primary helium contains a small quantity of radionuclides originating from radionuclide diffusion, rare defective particles, graphite impurities and low helium activation. Most of these radionuclides are trapped in

the graphite, deposited on metal surfaces or retained by the helium processing system. The building and its ventilation system limit and control discharges toward the exterior.

In the event of a reactor coolant system leak, the gaseous mixture released at the start of the accident will have very low radioactivity. On a more long-term basis, in the event of an increase in temperature, only a slight alteration of the fission product containment performance of the fuel particles is foreseen. The quantity of radionuclides released will remain very low, and the building's insulation will minimise radiological discharges.

Moreover, loss-of-coolant accidents never result in unacceptable consequences. Only an insertion of oxygen (air or water) may significantly damage the core.

Further to a break in the reactor coolant system, air may enter and oxidize the core graphite structures. It is therefore necessary to minimise this risk in the design. For large hypothetical breaks, the slowness of the associated gradient allows for implementing accident management procedures, thus preventing severe damage of fuel particles and core structures.

Water ingress into the reactor coolant system may occur in case of leakage in a heat exchanger pipe located within said system in certain designs. The potential associated risks are graphite oxidation (leading to the release of radioelements trapped inside the graphite), hydrolysis of defective fuel particles, and reactivity insertion (due to the increase in neutron moderation). Adequate design measures to reduce steam transport limit the consequences of such accidents. For example, the pressure in the water circuits interfacing with the reactor coolant system is less than the pressure of the primary helium, and these circuits are also equipped with isolation devices.

The modular HTR safety approach is currently being reassessed within the scope of a generic framework for future reactors. In Europe, it is mainly based on the safety approach adopted for the EPR PWR and EFR sodium-cooled reactor projects. The objective remains to make the most of the design options described above so as to limit the number of safety systems and associated requirements, particularly as regards the prevention of core damage accidents (highly improbable with this type of reactor).

Pascal ANZIEU,

Nuclear Development and Innovation Directorate

Sophie EHSTER,

AREVA-NP

HTR fuel cycles

As discussed earlier, HTRs offer high design flexibility. In particular they allow fine and local modulation of the neutron spectrum by adjusting the **moderation ratio*** and fuel particle composition and density. In addition, the low capture rate of parasite neutrons in the graphite moderator provides high neutron economy margins. Finally, the dispersion of the particle fuel makes it highly insensitive to local **self-shielding*** effects. Resonant neutron capture in fertile isotopes is very efficient, providing a high capacity for nuclear material conversion.

These characteristics give HTRs a high degree of fuel cycle flexibility. In particular, HTRs accept a large variety of mixtures of fissile and fertile materials (natural U, enriched U, Pu, Th) without significant changes in core design.

In addition, the high irradiation resistance of the particle fuel allows high burn-up, making the open fuel cycle attractive after fissile material burn-up. However, a closed fuel cycle can also be considered, fuel reprocessing permitting. Aqueous processing of particle fuel is not easy, since carbon-coated particles are insensitive to nitric acid and tend to form sludges (insolubility of carbide coatings in nitric acid). Nevertheless, once this technological problem has been overcome, numerous fuel cycle options will be available for this type of reactor.

A large number of studies have been conducted to assess and compare the performance of various fuel cycles for HTRs [1]. This section only covers three typical cycles:

- Open fuel cycle using medium-enriched uranium (~ 15%);
- Fuel cycle using plutonium;
- Fuel cycle using plutonium and minor actinides for a 600 MWth (284 MWe) GT-MHR type HTR with a **burn-up*** fraction of approximately 120 GWd/t.

Uranium cycle

The table below compares the actinide production of HTR U and PWR UOX fuels.

	HTR	PWR
Burn-up (GWd/t)	120	60
Medium enrichment (U 235)	15.6	4.95
Natural U requirement (t/TWhe)	22	21
SWU requirement (MSWU/TWhe)	0.021	0.016
Pu production (kg/TWhe)	17	26
Np production (kg/TWhe)	1.2	1.8
Am production (kg/TWhe)	1.0	1.5
Cm production (kg/TWhe)	0.04	0.04

HTRs may operate using uranium fuels with various degrees of enrichment (7 to 15% on average). However, the very high irradiation resistance of the particles is only exploited with high fuel **burn-up***, which is only possible with highly enriched uranium, typically 15% for a burn-up of 120 GWd/t. Natural uranium and an isotopic separation process are required to obtain this enriched uranium. Despite the high fissile material burn-up capacity and the higher efficiency of HTRs, the medium-enriched uranium cycle does not allow natural uranium savings, and the enrichment cost is 30% higher than for the uranium cycle in PWRs, for the same production of energy.

On the other hand, it must be noted that the medium-enriched uranium cycle decreases the production of plutonium and minor actinides (americium + curium) by a factor of 1.5.

Plutonium cycle

Water-cooled reactors are rather mediocre consumers of plutonium, since the maximum plutonium content permitted in their cores is limited by the **void coefficient***. HTRs are free from this limitation, and therefore potentially good plutonium consumers.

For example, there is a Russian project for the consumption of military plutonium in reactors of this type.

The neutronics of an HTR-Pu reactor have been studied at the CEA [2]. This study confirms the good neutronic behavior of an HTR core loaded with plutonium, even for isotopic compositions with low fissile isotope content, and up to high burn-up fractions.

Several types of plutonium fuels can be used in HTRs. Pu on depleted uranium supports (MOX) or inert matrix supports can both be considered, with a plutonium consumption of 85 and 100 kg/TWhe, respectively, and rapidly degrading quality (fissile isotope content) in both cases. Starting with plutonium with a fissile isotope content of 62%, the passage through a GT-MHR type reactor leads to a mean fissile Pu content of 30 to 40% in the remaining plutonium after 5 years of cooling. This degradation in plutonium quality makes it difficult to implement plutonium multirecycling processes in HTRs.

The studies conducted by the CEA have established a core plutonium content threshold value (50% of total plutonium) beyond which the startup reactivity margin is no longer sufficient and the irradiation cycle time becomes too short.

A simulation of the introduction of plutonium-recycling HTRs in a reactor fleet producing 400 TWhe provides an indication of the time period beyond which this limit will be attained.

Assuming the pursuit of plutonium mono-recycling (in MOX fuels) in current PWRs until 2025 and the introduction of GT-MHR HTRs as of that date to contribute 20% of total energy production and ensure plutonium recycling in MOX, UOX and HTR fuels, Figure 48 below shows the evolution in core plutonium quality. In particular, it shows that as of 2070 the mean plutonium quality in the reactor fleet (80% PWR UOX and 20% HTR Pu) will no longer enable plutonium recycling with the same burn-up fractions in HTRs. The degradation in plutonium quality leads to the insertion of increasing quantities of plutonium in the core, namely plutonium resulting from HTR fuel processing beyond 2050. This date can be pushed back by reducing the share of HTRs.

The symbiosis between a Pu-producing PWR fleet and a Pu-burning HTR fleet would therefore stabilize the plutonium inventory, but only temporarily (Fig. 49). However, the introduction of plutonium-burning HTRs could represent an interesting solution in the case of a policy aimed at minimising the Pu quantity in the fuel cycle (or adjusting it to meet the requirements of future fast reactors).

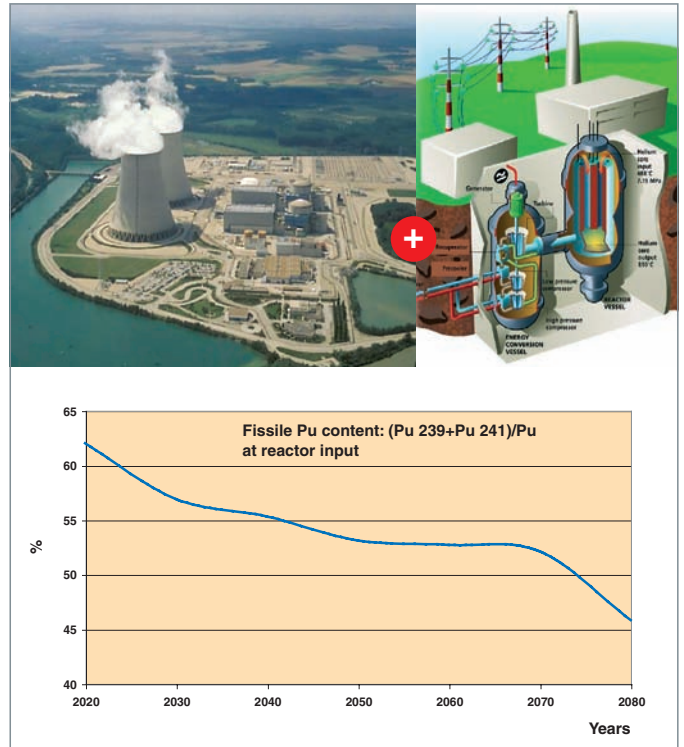

Fig. 48. Temporal evolution of fissile plutonium content for a mixed PWR (UOX) and HTR (Pu) reactor fleet.

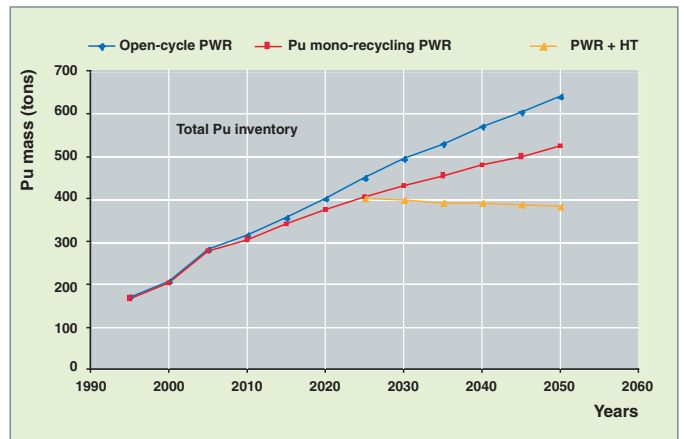

Fig. 49. Temporal evolution of plutonium inventory for various scenarios in France: PWR fleet without recycling, PWR fleet with mono-recycling, and mixed PWR (80%) - HTR (20%) fleet. In the latter scenario, the plutonium extracted from the PWRs is burned in the HTRs (incompletely and in a single passage).

Recycling of minor actinides

Plutonium recycling in HTRs leads to the production of approximately 7 kg/TWhe of americium and 4 kg/TWhe of curium (after 5 years of cooling of unloaded fuel).

Figure 50 below shows the evolution of the minor actinide inventory in spent fuels and glass packages for the HTR Pu recycling scenario. It must be noted that the minor actinide inventory will amount to 170 tons in 2070 if the current situation is extended (i.e., Pu mono-recycling in PWRs).

The first studies concerning the recycling of these actinides with plutonium in a GT-MHR have not enabled the identification of an equilibrium state with equivalent consumption and production of americium and curium in a given reactor fleet. The consumption of americium decreases with the number of recyclings. This is because in order to maintain an acceptable reactivity margin, it is necessary to reduce the length of the irradiation cycle or the quantity of minor actinides loaded. At best, the consumption of americium is approximately 20 Kg/TWhe in the first cycle. In the fifth irradiation cycle, the balance becomes positive. In all cases, the curium balance remains positive and production decreases with the number of irradiation cycles. However, these results must be considered with caution, as they largely depend on the choice of scenario and simulation hypotheses.

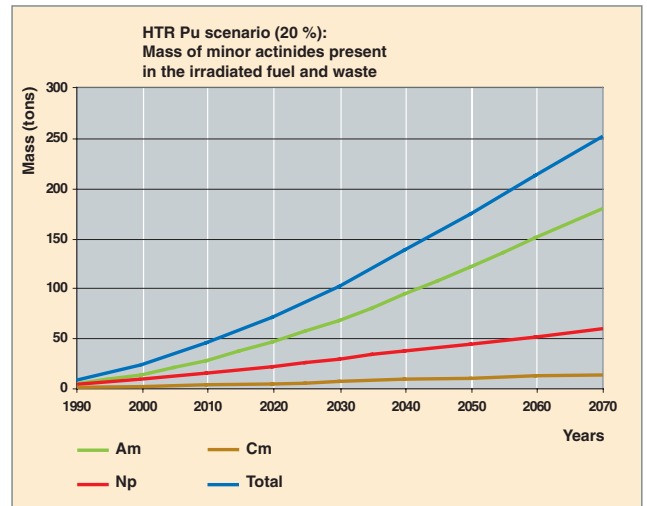

Fig. 50. Minor actinide inventory for the HTR Pu recycling scenario.

► References

- [1] International Atomic Energy Agency, *International Nuclear Fuel Cycle Evaluation (INFCE)*, Vienna (1980).
- [2] Frédéric DAMIAN, thèse CEA : "Analyse des capacités des réacteurs à haute température (HTR) sous l'aspect de l'utilisation des matières fissiles", INPG, Grenoble, 2 février 2001.

Jean-Paul GROULLER,
Reactor Research Department

Waste from High-Temperature Reactors

What types of waste are produced by High-Temperature Reactors?

The waste produced by an HTR consists in part of irradiated fuel elements (compacts or pebbles consisting of multilayer particles encased in graphite), and partly of structural elements consisting entirely of graphite.

The irradiated fuel elements themselves have a graphite content of 90 % by weight. The remaining 10% is made up of the oxide or actinide oxycarbide kernel and the coating layers surrounding it (Fig. 51).

The scenario most often envisaged for the HTR consists of a single irradiation passage through the reactor, followed by the **direct storage*** of the spent fuel in a deep geological disposal facility. However, the processing and recycling of fuel is the preferred option for PWRs in France. Moreover, the criteria defined within the Generation IV Forum, especially those relat-

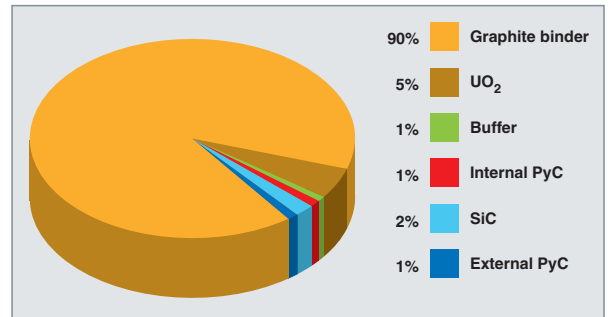

Fig. 51. Composition by weight of an HTR fuel element (pebble or compact).

ing to sustainable development (minimisation of the volume and potential **radiotoxicity*** of the waste), imply a preference for the recycling of all the actinides contained in the spent fuel, with the graphite and fission products being handled separately.

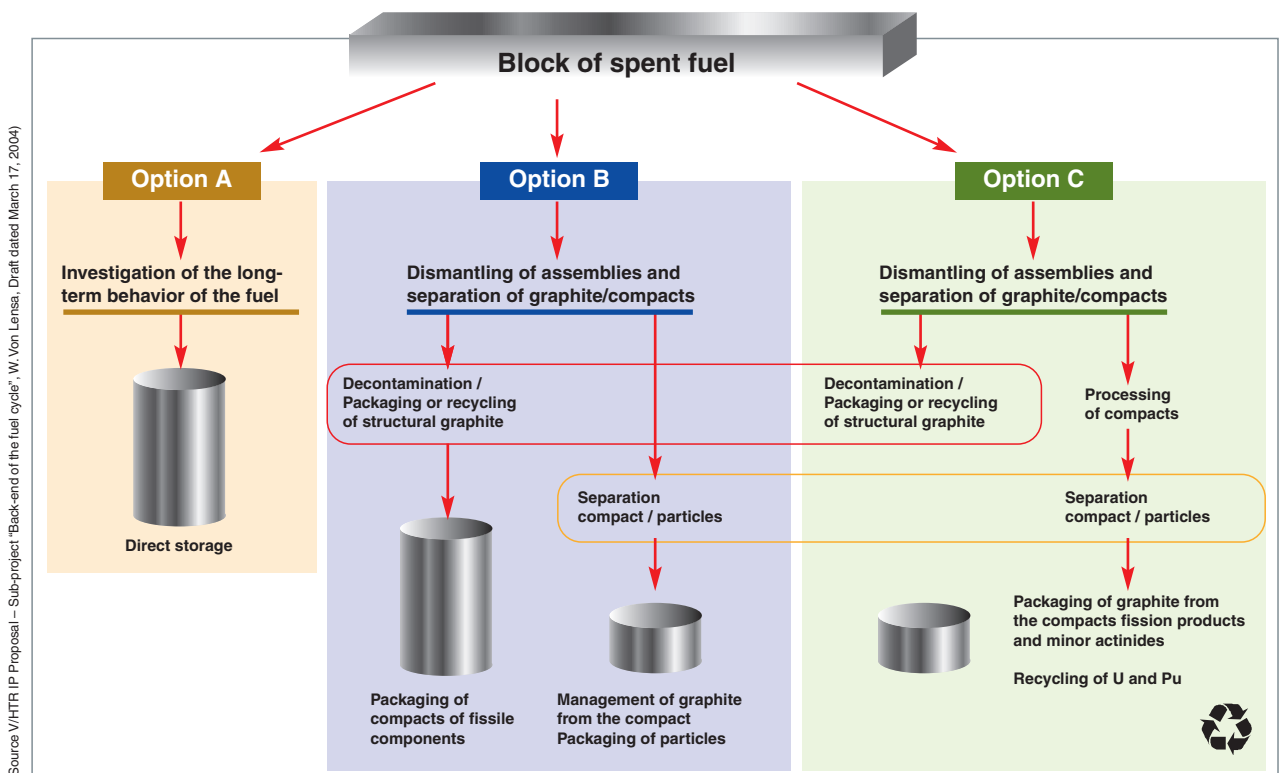

Fig. 52. Schematic description of the options for processing HTR waste.

Three strategies for the management of HTR waste are then possible [1] (Fig. 52):

- **Option A:** Direct storage of all structural and fuel waste in its original condition. This option assumes no processing or recycling of the material, but it is extremely costly in terms of the volume of waste to be stored.
- **Option B:** Dismantling of assemblies, separation of the particles and the graphite in the compacts, storage and possibly packaging of the particles, decontamination, packaging and recycling of the graphite.
- **Option C:** Similar to option B, with additional processing of the particles with the aim of recycling all the actinides and packaging of the fission products and carbon.

Option C is a continuation of the current French strategy applied to UOX nuclear fuels from PWRs, with a minor variation in terms of the recycling of the actinides. In the case of an HTR, U and Pu are recovered by reprocessing, while the minor actinides are vitrified along with the fission products.

The question of HTR waste can therefore be broken down into two separate themes, each of which will be discussed in turn in this section.

Firstly, is the long-term behavior of the spent fuel compatible with direct storage in a geological disposal facility?

Secondly, can the experience gained with NUGG reactors be applied to the management of the graphite?

The management of HTR fuel after leaving the reactor: Direct storage, repackaging or reprocessing?

The long-term behavior of HTR fuel under storage conditions

The design itself of a particulate fuel, *i.e.* one consisting of fissile kernels encased in a multi-layer envelope, is in principle compatible with the option of direct storage of spent fuel (options A and B in Fig. 52). The various layers surrounding the fissile kernel are designed to prevent the migration of fission products during, and potentially beyond, the life of the fuel elements in the reactor.

The potential release of fission products is associated partly with the intrinsic alterability of the particle kernel, and partly with the diffusion of radioelements through the various layers of silicon carbide (30 μm in thickness) and pyrolytic carbon⁹.

Silicon carbide: A material resistant to leaching

Used in heating elements, cutting tools or to support a catalyst, silicon carbide is a ceramic with remarkable physical and chemical properties. In addition to a melting point of 2,830 °C, which enables it to be used in air up to 1,500 °C, it is also resistant to thermal shock and is chemically inert to corrosive agents such as water as it forms a protective layer of silica on the surface.

The HTRs which operated (in particular AVR, Dragon and Fort-Saint-Vrain) have shown that a SiC layer is an effective barrier to diffusion during the irradiation phase in a reactor, *i.e.* at high temperature and over a relatively short period of time (around 1,000 °C for a number of years). The rates of release of a number of fission products have been measured at temperatures between 800 and 1,600 °C. A limited number of fission products, including cesium, strontium and silver diffuse weakly and partially through the particle and these phenomena are strongly dependent on the manufacturing quality of the particles [3]. Over the time periods corresponding to the storage phase, the rate of diffusion of fission products will be much slower due to the eventual lower temperature (50 °C) but the diffusion will take place over a much longer period of time (10⁵ years).

Extrapolating the diffusion coefficients of the fission products measured at high temperatures to the lower temperatures in geological storage (50 to 90 °C) and over very long periods of time enables the lifetime of spent HTR fuel to be predicted. There are however risks in this process as the fission product diffusion mechanisms in SiC are different at high and low temperature.

In addition, the ability of SiC to withstand irradiation is satisfactory as it maintains its cubic crystal structure. However, the mesh parameters show a clear change, indicating that the stoichiometry of SiC is modified to a composition of type SiC_{1-x}. The consequences of this phenomenon for the long term radiation resistance have still to be evaluated.

Finally, leaching experiments carried out using water from granite, saline and clay strata have revealed the formation of an oxide layer which limits the dissolution of the matrix over the medium term [2]. This gives confidence in the long term integrity of the SiC layer.

9. Current understanding indicates that a proportion of the particles are likely to become cracked, either as a result of prior manufacturing defects, as a result of their passage through the reactor, or as a result of the processing to separate the particles and the graphite. This contributes greatly to the potential release of radioelements from the fuel.

The fissile kernels may vary widely in type and composition (e.g. UO_2 , UCO , $(\text{U,Th})\text{O}_2$, PuO_2). These materials are all highly stable under water in the absence of oxidants.

Initial studies have also demonstrated that the SiC layer is highly resistant to **leaching*** [2]⁹.

The highly porous nature the graphite encourages the penetration of water as far as the outer layer of PyC. The corrosion of this layer may be assumed to be negligible, other than through radiolysis.

The experimental data so far available relating to the behavior of HTR fuel under direct storage conditions is therefore encouraging. However, the majority of the results have been obtained from experiments on model systems using non-irradiated particles in the kernels and samples of SiC exposed to radiation. For this reason, investigations into the long-term behavior of actual materials are still continuing in Europe [1,2] and throughout the world¹⁰.

10. See box below.

The long-term behavior of HTR fuel under storage conditions

The current situation in France is that fuel from PWRs is reprocessed by COGEMA in order to recycle the U and Pu, with the fission products and minor actinides being vitrified. However, the **direct storage*** of UOX and MOX was studied by the CEA in the framework of the 1991 law related to the management of long lifetime waste (PRECCI program).

The studies carried out under the PRECCI program resulted in the implementation of a methodology based on the characterization of changes in the fuel for a range of conditions: The first phase covers “closed system changes” occurring in the dry fuel, “unsaturated system changes” occurring in fuel exposed to a moist gaseous atmosphere, and “saturated system changes” occurring in fuel in the presence of water. The closed and unsaturated systems correspond to temporary storage and storage in the disposal facility before it becomes saturated with water. The saturated system corresponds to long term storage.

A full understanding of the behavior of spent HTR fuel in permanent storage also requires the identification and quantification of the following parameters:

1. The various **source term*** radionuclides.
2. The mechanisms governing the changes in these inventories over time, including: Radioactive decay, diffusion of the fission products through the various layers of the particle at temperature and under irradiation, and changes to the integrity of the layers and surface, particularly under the influence of gasses such as helium and fission gasses.
3. The mechanisms governing the changes and release of fission products by the various layers of the particle in the presence of water (leaching).

A number of **radionuclide inventories*** need to be considered. The **labile*** inventory includes all the radionuclides (especially Cs 135, I 129 and Cl 36) likely to be released instantaneously as soon as water comes into contact with the fuel particles. This **source term*** does not depend on the containment properties of the various layers. It depends only on the quantity of fission products adsorbed or segregated on the external surface of the layers and the accessibility of water. It should be noted that the SiC layer on HTR fuel forms an effective diffusion barrier and this should reduce the labile inventory considerably in comparison to present UOX and MOX fuels. The labile inventory is strongly dependent on the physical condition of the fuel when it is first exposed to water (especially any breaks in the SiC layer, cracks in the layers, and the porosity of the graphite), and on its physical and chemical condition (chemical forms and locations of the fission products). The other inventories include radionuclides dissolved or occluded in the various layers of the fuel (graphite, PyC, SiC or ZrC, and the kernel).

The quantification of the potential release of fission products from the particles will require an evaluation of the diffusion coefficients as a function of temperature and product type through the various layers, especially the SiC. This data will be needed in order to determine the underlying mechanisms governing the diffusion (intra and intergranular diffusion, the role of point and extended defects, and potential activation under self-irradiation).

The release of these radionuclides is dependent on changes in the layers due to the presence of water. The first studies into the chemical durability of the particles were based on leaching and monitoring the release of radionuclides, and evaluated the performance of each layer (pyrolytic carbon, SiC, graphite, fuel kernel) in isolation with regard to changes due to exposure to water. These studies showed that the proportion released in each case was very low.

Can the fuel particles be reprocessed?

The reprocessing of particulate fuel was studied on a laboratory scale in the 1960s and 1970s in the USA and Germany [3].

The reprocessing procedure envisaged at the time was as follows: The compacts are initially ground up and burned to eliminate the graphite and SiC. The bare kernels are then hydrometallurgically dissolved and the actinides (U, Pu, Th and the minor actinides) are extracted and recycled. This last operation currently aims to separate out the group of elements containing Am, Cm and Np. The efficiency must exceed 99.9 % in order to meet the criteria for the reduction in volume and radiotoxicity of the waste on the one hand and non-proliferation on the other.

The major difficulty encountered during these studies was related to the actual design of the fuel. The SiC coating, which provides such an effective chemical barrier to the diffusion of fission products even at high temperature, was found to be very difficult to destroy. This carbide layer is both resistant to grinding and refractory during incineration. Temperatures of around 1,300 to 1,400 °C are needed for combustion and this causes the partial vaporization of the fission products.

The improvement of reprocessing procedures for these particulate fuels is currently being studied both by the CEA and in laboratories outside France such as the Argonne National Laboratory in the USA and FZJ in Jülich in Germany.

The break-up of graphite using pulsed current techniques is currently under development by the CEA as a means of efficiently separating the fuel particles from the graphite matrix. Figure 53 shows the conclusive results obtained using this technique on TRISO particles with zirconia kernels.



Fig. 53. Break-up of TRISO particles (ZrO₂ kernels) by pulsed current from a Marx generator (1 pulse per second - Voltage: 250 kV – Discharge time: 200 nS – Peak current: 6 kA).

The alternative technique of burning off the graphite is also being studied.

The dissolution of the fissile kernel is also under investigation using processing techniques based on a halogenated gaseous phase, or in a bath of molten chlorides, sodium hydroxide or carbonates. The final stage to extract the actinides is expected to use a hydro or pyrometallurgical method depending on the technology chosen for the preceding processes.

The waste produced by the reprocessing of these fuels includes both fission products (in traditional nitric solutions, as halogen salts, or in the form of metallic waste if pyrometallurgical processes are involved), and carbon in a variety of forms: Ground up graphite of various granulometries, or silicon carbide and carbonates dissolved in the fission product solutions. The process of vitrification of nitric solutions of fission products has been proved in a production environment both in France and elsewhere. The long-term behavior of the nuclear glass produced under geological storage conditions has been well documented. It will be necessary to carry out more work on the glass compositions in order to match them to the chemical composition of the highly active solutions (both in terms of the fission product spectrum and the additive or corrosion effects associated with earlier stages in the reprocessing).

Suitable matrices for the long-term containment of saline or metallic waste containing fission products are currently under development on a laboratory scale at the CEA and in other countries under European contracts [4].

The work so far carried out indicates that all contaminated salts may be packaged in a composite matrix consisting of a sodalite type phase (Na,K)₈Al₆Si₆O₂₄Cl₂, holding the alkalis and chlorine, embedded in a vitreous phase intended to hold the other fission products consisting mainly of alkaline earth metals and rare earths.

Irradiated graphite as nuclear waste

Graphite from NUGG reactors

The situation in France

The quantity of irradiated graphite produced by NUGG reactors in France amounts to 22,700 tonnes, or around 10 % of total quantity produced worldwide. Most of this graphite (around 80 %) originates in the pile in NUGG reactors (Fig. 54) and is **stored*** within the reactors themselves until decommissioning makes it necessary to remove the graphite.



(Source : ANDRA)

Fig. 54. View of the graphite block pile in the Chinon NUGG reactor.

The radiological inventory of this graphite indicates that the total activity is around 5 MBq.g^{-1} after a five-year cooling period during which the radioelements with short half-lives disappear. Over longer periods of time, the radionuclides resulting in the most significant storage problems are C 14, Cl 36, H 3, and to a lesser degree Ni 63 and Ca 41. The largest component is the C 14 which accounts for 90 % of the total activity after 120 years of cooling, followed by the Cl36 which, although having a low specific activity of between 0.3 kBq.g^{-1} and 2.0 kBq.g^{-1} depending on the component and reactor concerned, decays with a half-life of 300,000 years and is poorly contained in geological strata.

Management of irradiated graphite from NUGG reactors

The overall radiological activity of the long-life radionuclides, in particular that of the C 14 contained in all irradiated graphite makes it impossible to consider storing unprocessed graphite in the Aube Storage Center.

Solutions aimed at reducing the volume, such as the incineration of the graphite, have been investigated [5]. However, as the release of C 14 in the form of CO_2 is not acceptable, the sequestration of C 14 at a reasonable economic cost remains a problem for this method of disposal.

The present intention is to store the 22,700 tonnes of irradiated graphite from NUGG reactors in a future surface or sub-surface storage facility currently being studied at ANDRA.

Packaging solutions capable of guaranteeing the long-term containment performance are being studied. Several types of systems have been considered in the past. The packaging of carbon 14 in the form of carbonates encased in a cement matrix is currently the most developed option. This method is also being used in production at the Thorp facility at Sellafield in Great Britain (trapping of carbon by washing in sodium hydroxide, followed by the precipitation of BaCO_3 by $\text{Ba}(\text{NO}_3)_2$ which is then encased in a cement binder).

An alternative method involving the manufacture of ceramics by hot sintering are currently being investigated by the CEA. Recent work has focused on the preparation and characterization of a mixed Ca / Ba ceramic and the feasibility of silicon carbide is also being studied.

Graphite from future High-Temperature Reactors

Estimation of the flux of irradiated graphite from HTRs

As in NUGG reactors, graphite is one of the main materials to be used in future thermal neutron spectrum High-Temperature Reactors (HTR). This material is used in the core, where it acts as a moderator of neutrons, in structural components, and as a thermal barrier.

The irradiated graphite produced in future reactors will constitute a major source of waste. For example, a 600 MWth high-temperature reactor using prismatic blocks could produce 6,140 tonnes of irradiated graphite in the course of its 60-year operating life. This irradiated graphite flux consists mainly of reflector blocks which need to be replaced periodically as the mechanical properties are degraded by radiation, and graphite used in the fuel itself. The lifetime figure of 6,140 tonnes is made up of 3,540 tonnes from the partial replacement of the reflector blocks every six years, 2,340 tonnes from the fuel blocks and fuel removed during the annual refueling process, and 260 tonnes from the permanent reflectors removed during decommissioning. This latter type of graphite is considered to be type B waste, as the calculated C 14 content exceeds the acceptable limits for surface packages by a large margin.

Solutions for the management of graphite from HTRs

The requirement is to adopt a strategy aimed at reducing the quantities of graphite waste produced. This strategy may involve limiting the radiological activity resulting from activation, and researching solutions for the decontamination, recycling and reuse of irradiated graphite.

Main activation products from irradiated graphite					
Main AP / irradiated graphite	Half-life* (years)	Initial impurities in the graphite (average values used in the calculations)	Main precursor isotopes (& natural abundance)	Type of reaction with neutrons	Cross section (barns)
C 14	5,736	C = 100%- other impurities	C13 (1.1 %)	n. gamma	5.00E-04
		N = 100 ppm	N14 (99.6 %)	n. p	6.20E-01
		O ₂ (negligible)	O17 (0.4 %)	n. alpha	8.50E-02
Cl 36	300,000	Cl = 3 to 12 ppm	Cl35 (75.4%)	n. gamma	1.50E+01
H 3	12.3	Li = 0.1 ppm	Li6 (7.5 %)	n. alpha	3.20E+02
		B = 0.7 ppm	B10 (18.3 %)	n. alpha	1.30E+03
Co 60	5.27	Co = 0.07 ppm	Co59 (100 %)	n. gamma	6.30E+00
Ni 63	100	Ni = 5 ppm	Ni 62 (3.7 %)	n. gamma	4.90E+00

The long-term radiological activity in the mass of irradiated graphite results from activation products (AP) generated by the irradiation of impurities initially present in the graphite. These activation products depend on the reactions resulting from interactions with the neutrons, and the yield depends on the capture cross section of the corresponding initiators. These are shown in **barns*** (10^{-24} cm²) in Table above.

The impurities critical to the objective of reducing the radiological inventory can be identified by means of the activation simulations carried out for a number of thermal HTR designs and the experience gained from the decommissioning of NUGGS. The main impurities to be reduced as far as possible are firstly nitrogen, followed by chlorine and the lithium-boron pair. The other activation products, such as cobalt which can pose problems of radiological protection, are less critical from the point of view of long-term waste.

Nitrogen (which is present at a concentration of around 100 ppm in the pores of the graphite) is the cause of almost 90 % of the total C 14 activity (1.7 MBq/g after 60 years of irradiation). After a further 50 years of cooling, this radioisotope accounts for 99 % of the total activity of the graphite. The proportion of C 14 generated by capture (n, gamma) by C 13 remains small compared to that caused by nitrogen due to the small cross section of the C 13. It does however represent the “incompressible” portion of the C 14 at less than 0.2 MBq/g after 60 years of irradiation (permanent reflector). This level of activity is compatible with surface storage.

It would therefore be a significant advance if the nitrogen in the pores of the graphite could be replaced by a gas with little or no impact on activation such as helium. The graphite manufacturers are continually improving their control of the other impurities, and they are now offering purified and ultra-purified graphites with impurity specifications even better than the limitations associated with the waste problem¹¹.

11. The specifications of the graphite marketed by TOYO-TANSO, the supplier of graphite to the Chinese HTR10 and Japanese HTTR reactors, can be found on the website: www.ttu.com.

In order to reduce the flux of graphite waste, the recycling of irradiated graphite is also being considered, either by reusing the graphite blocks in a reactor after heat treatment to heal the defects caused by irradiation, or by the preparation of carbides or other carbon-based materials for use in the nuclear industry.

► References

- [1] W. von LENSEA *et al.*, “Back-end of the fuel cycle (BF)”, Contrat européen V/HTR IP proposal – Subproject draft March 17, 2004.
- [2] A. LANGUILLE et M. PELLETIER, “Comportement du combustible en réacteur”, dans *Revue générale du nucléaire*, 6 (2002), p. 56-59.
25. “Annual progress report”, European contract HTR-N & N1, October 2003.
- [3] P. BROSSARD, “Le retraitement du combustible à particules”, *Revue Générale du Nucléaire*, 6 (2002), p. 56-59.
- [4] “Final report”, European contract PYROREP [2003]).
- [5] “Nuclear graphite waste management”, in *Proceedings of the technical committee meeting*, Manchester, United Kingdom, October 18-20, 1999.

Florence BART

Waste processing and conditioning Department

With contributions from:

Christian BOURDELOIE (DEN/DTN/STPA)

Fabienne DELAGE (DEN/DEC/SPUA)

Christophe JÉGOU (DEN/DTCD/SECM)

Danièle ROUDIL (DEN/DTCD/SECM)

Vincent ROYET (DEN/DTEC/STCF)

Very High-Temperature Reactors (VHTRs): Numerous benefits of higher temperatures

Electricity production

HTRs were developed in the 1970s. Reactors of this type were subsequently built and operated. At the time, numerous technological test facilities were also built (eg, to test the performance of direct-cycle gas turbines, the heat resistance of refractory concretes, or the oxidation resistance of graphites).

The pursuit of increased system performance led to the idea to increase the reactor operating temperature. According to the Carnot principle, the efficiency of a reversible thermodynamic system increases with temperature as follows:

$$\eta = 1 - T_2/T_1$$

where T_1 and T_2 are the absolute temperatures of the hot and cold source, respectively.

If technologically possible, increasing the core outlet temperature approximately 100 degrees improves efficiency by several points¹². For example, under otherwise identical conditions, the electrical production efficiency of an industrial machine operating on a direct Brayton-cycle with helium as the working fluid increases from 50.5 to 56% when T_1 increases from 850 to 1,000 °C (Fig. 55, blue curve).

However, the technological constraints associated with the resistance of the reactor vessel steel limit the foreseeable increase, *i.e.*, an increase in core outlet temperature is generally accompanied by an increase in helium return temperature near the reactor vessel. The best reactor vessel material currently being developed (chrome steel) does not withstand temperatures above 490 °C. With a core outlet temperature of 1,000 °C and a helium return temperature of 490 °C, the electrical production efficiency is only 53% (Fig. 55, green curve).

The benefits of higher temperatures are apparent, but also the difficulty of achieving them. On the one hand, each point of increase in efficiency translates into a 2% decrease of the kilowatt-hour cost for a given investment. On the other hand, the increase in temperature requires the use of more expensive materials or greater system complexity (*e.g.*, addition of cooling systems), so economic efficiency will need to be examined in detail once the solutions have been qualified.

For a given investment and operating cost I , the kilowatt-hour cost c is inversely proportional to the energy produced E : $c = I/E$.

With an efficiency r_1 , E_1 is produced at cost c_1 . With an efficiency r_2 , the cost to produce the same amount of electricity is $c_2 = c_1 * r_1/r_2$. For example, with $r_1 = 50.5\%$ and $r_2 = 53\%$, we obtain $c_2 = 0,95 * c_1$.

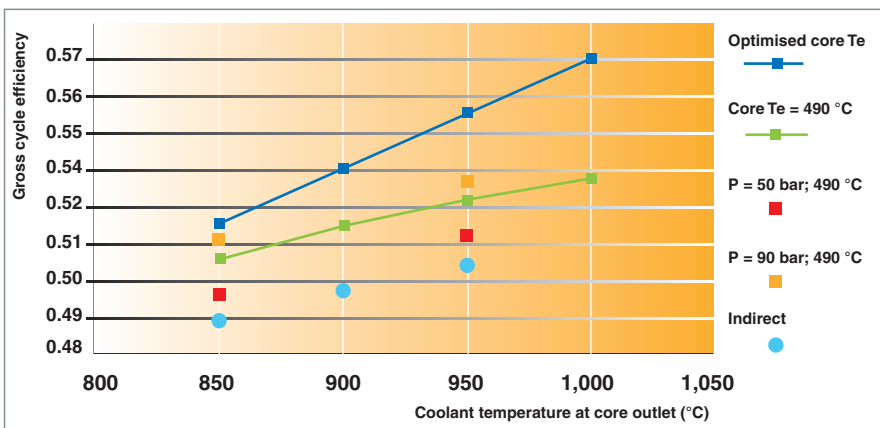

Fig. 55. Electrical production efficiency of a VHTR using a direct helium cycle (Brayton), as a function of core outlet temperature and return temperature (T_e). Depending on the reactor vessel steel used, a low return temperature may be necessary to prevent embrittlement (in this case $T_e = 490$ °C for chrome steel, green curve), which produces a reduction in efficiency as compared to unconstrained conditions (blue curve).

An increase in efficiency of 2.5 points amounts to a 5% decrease in production cost. Moreover, increasing the efficiency without modifying the fuel quantity used, which is the case when switching from an HTR to a VHTR, leads to a proportional decrease in the quantity of radioactive waste created per kilowatt-hour produced. The benefit of increasing the temperature is therefore apparent.

12. For more details, see *infra*, p. 89-95.

Hydrogen production

Very high temperatures also allow the possibility of producing hydrogen directly via **thermochemical cycles**^{*}, without transforming heat into electricity. Hydrogen is a good substitute for hydrocarbon fuels because its combustion in air yields only water and does not degrade the environment. But hydrogen does not exist naturally in free state. It needs to be produced. Dissociating a water molecule is an attractive solution, with the water cycle (dissociation and combustion) constituting a closed and clean cycle, but it is energetically costly. We currently know how to produce hydrogen by water electrolysis, but at a very high cost. We generally prefer to use light hydrocarbons, making them react with high-temperature steam. For example, methane reformation with steam consists of the following reaction:

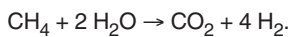

The reformation is performed at over 700 °C, burning part of the methane to produce the heat required. This rather economic process consumes hydrocarbons and produces carbonic gas contributing to the greenhouse effect. The concept of using nuclear heat as an energy source and water as a resource allows the possibility of much more sustainable industrial production without greenhouse gases.

In order to chemically dissociate a water molecule, various reaction methods can be considered. They involve intermediate steps with additional products that are recycled in the process. The most simple and promising methods, in terms of efficiency, operate at very high temperatures, typically above 900 °C, hence the interest for a heat source exceeding 950 °C. For example, sulfur-based cycles use a sulfuric acid dissociation reaction that only works above 870 °C and whose efficiency increases with temperature (Fig. 56). It is hoped that such methods will yield energetic efficiencies¹³ close to 50%¹⁴.

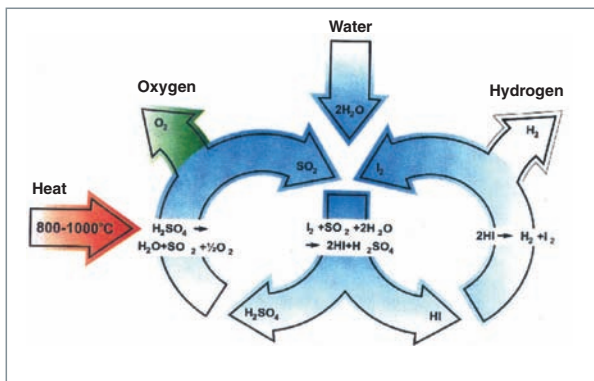

Fig. 56. Hydrogen production by iodine-sulfur **thermochemical cycle**^{*}. This cycle decomposes the water molecule using heat at over 870 °C.

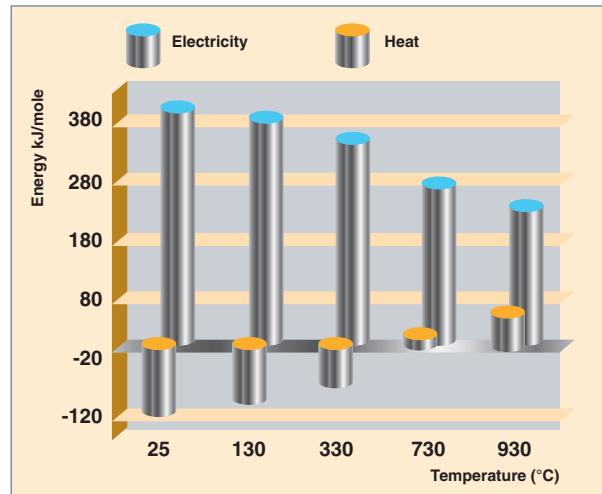

Fig. 57. Energy required to dissociate a water molecule by steam electrolysis, as a function of temperature. Below 600 °C, electricity is partly lost heating the water. Above this temperature, the direct heating of the water reduces the electricity required.

We can also dissociate a water molecule by steam electrolysis. Preheating the water vaporizes and superheats it, thereby decreasing the electrical energy required for its dissociation. The direct use of heat minimises losses associated with the transformation of heat into electricity (Fig. 57).

As described above, the electrical transformation efficiency of an HTR is approximately 50% (as compared to only 30% for a PWR). Assuming an electrolyzer efficiency of 80% at 900 °C, the global efficiency of the system is 40%. On the other hand, if part of the reactor's calorific energy is used to heat the electrolyzer and to decrease the share of electricity required, the global efficiency can be increased by several points so as to approach 50%.

Again, as in the case of electricity production, the final criterion is the cost of the hydrogen produced, but good efficiency is essential no matter what method is used.

13. The concept of efficiency for a hydrogen production process needs to be defined, as it is far from simple. The efficiency is defined as the ratio $\frac{\Delta H_{\text{eau}}}{Q + (W/\eta_e)}$, quotient of the water formation enthalpy at ambient temperature and atmospheric pressure, *i.e.*, 286 kJ/mol, divided by the sum of the energy produced by the process ($Q + W/\eta_e$), *i.e.*, heat Q plus work W divided by yield η_e .

14. See section, p. 103-108: "Nuclear production of hydrogen?"

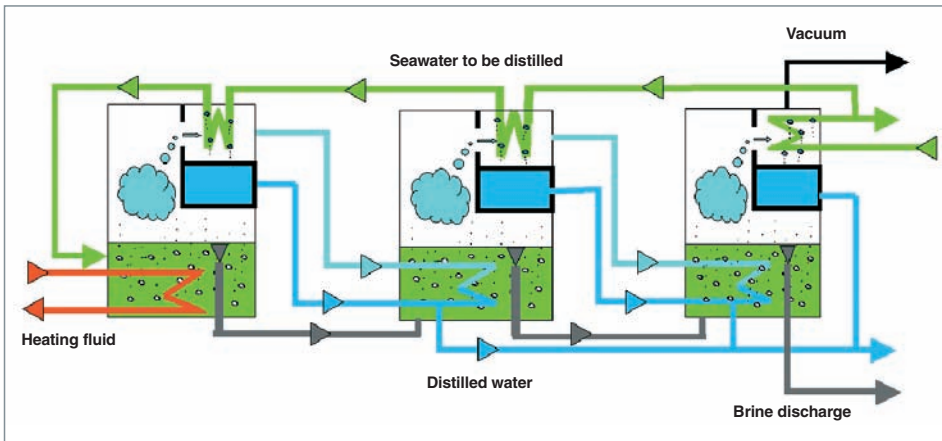

Fig. 58. Multiple-effect saltwater distillation process to produce fresh-water. The orange circuit provides heat at a temperature of approximately 120 °C, typical of the discharge temperature of an HTR.

Water desalination

Saltwater desalination at low cost is another interesting application of HTRs. The production of freshwater constitutes a major challenge for numerous countries in the years to come. Seawater desalination technologies are already available

and industrially implemented throughout the world, but their cost is high. Water desalination processes require mechanical or heat energy, depending on the method used.

For example, we can vaporize saltwater and condense the steam obtained, which no longer contains salt. This process is efficient at temperatures above 120 °C (Fig. 58). HTR thermodynamic cycle optimisation processes produce temperatures of 120 to 130 °C, depending on the circuits used

(Fig. 59). This heat is released to the exterior and it is perfectly possible to install a desalination circuit. In that case, only the cost of the desalination circuit needs to be considered. The heat is free (normally unused), thereby reducing desalination costs. Moreover, by increasing the hot temperature of a VHTR, we also increase the temperature of this heat energy by a few tens of degrees, making the desalination process even more attractive.

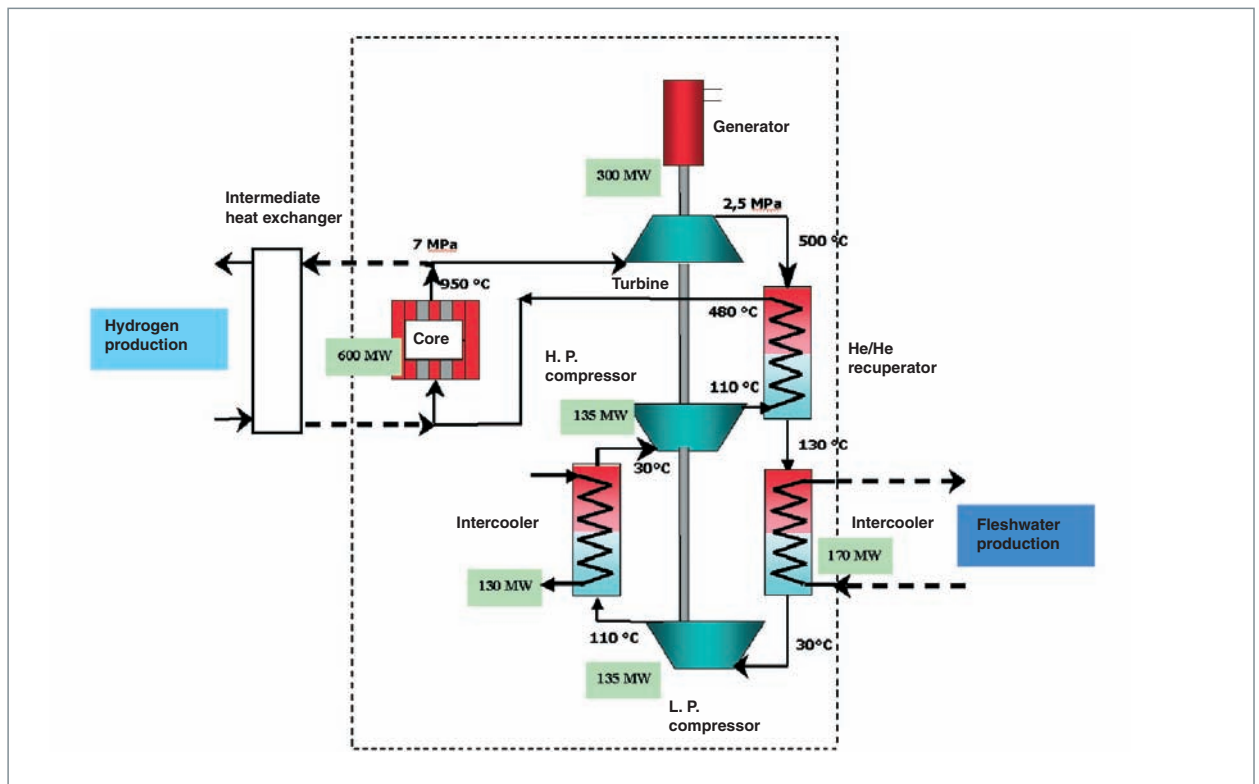

Fig. 59. Basic diagram of a VHTR using a direct helium cycle. The heat at 950 °C powers a high-performance turbomachine (high-efficiency electricity production) and a thermochemical cycle hydrogen

production unit. The residual heat is evacuated to the cold source at a temperature of 130 °C and can be used freely for saltwater desalination.

NGNP project (USA)

Simultaneously with the international structuring of research on future reactor systems (Generation IV International Forum), in 2003 the US Department of Energy (DOE) announced the construction of a VHTR prototype in the near future. Referred to as the Next Generation Nuclear Plant (NGNP), this prototype should demonstrate high-efficiency electricity production and hydrogen production capacities.

The objective is twofold: to produce a prototype that can be marketed as such in an electronuclear fleet, and to promote associated research and development for innovation. The initial development plan was very ambitious (construction between 2011 and 2015). Subsequent innovation scheduling analyses showed the need for a transition period from recognized HTR technologies to the more ambitious VHTR technologies described above. The NGNP is now scheduled to begin operation in 2018.

The specifications for this reactor project are covered in document [1]. It consists of a 4th generation VHTR prototype to be financed by the DOE and a consortium of US research centers and industrial partners. The NGNP will be built at the Idaho National Laboratory (INL) [Fig. 60].

The main characteristics of this reactor are the following:

- Helium-cooled reactor;
- Helium temperature at core outlet: 1,000 °C;
- Modular reactor with an output power of 300 to 600 MWth;
- **TRISO*** particle fuel;
- Graphite core (prismatic or pebble bed);
- Hydrogen coproduction;
- Attractive safety characteristics.

The NGNP should produce electricity at an attractive cost. Its temperature of 1,000 °C should allow for an efficiency of 50%. Technologies suitable for operating at such temperatures will need to be developed based on the knowledge acquired in previous HTR projects. The core temperature increase of 150 °C (under otherwise identical conditions) requires the confinement of fission products within multilayer particles. Metallurgists consider that the exposure of internal components and circuits to temperatures exceeding 950 °C imposes a radical change in the choice of materials. Further research on energy conversion systems coupled to a direct helium cycle turbomachine will also be necessary.

Hydrogen production demonstrations will concern two processes. A high-temperature thermochemical cycle capable of directly using the heat produced will be tested using the iodine-sulfur cycle as the reference. It will be coupled to a production loop drawing 50 MWth from the NGNP. The resulting production will amount to approximately 500 kg/h of hydrogen, the equivalent of 40,000 liters of gasoline per day. The second demonstration, to be conducted in parallel, will concern hydrogen production by high-temperature electrolysis with an equivalent output power (*i.e.*, 5 MWth and 20 MWe). A basic diagram of the NGNP concept is shown in Figure 61.

The choice of core type (prismatic or pebble bed) will be postponed until after the preproject phase, thus allowing the various engineering teams involved to defend their positions. The Generation IV International Forum is organizing R&D activities on the VHTR in support of this project.

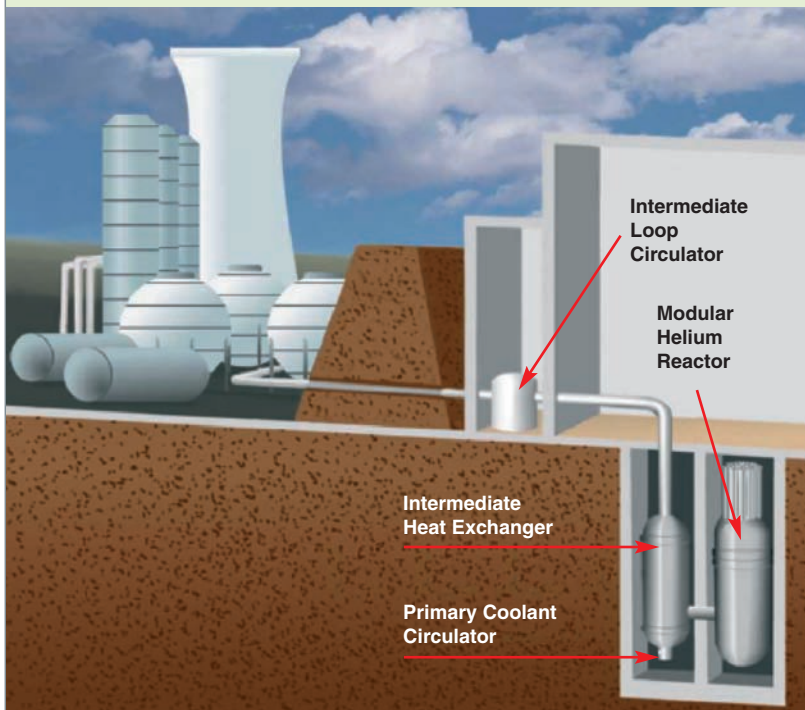

Fig. 60. Illustration of the NGNP at the Idaho National Laboratory, showing the hydrogen production demonstration loops.

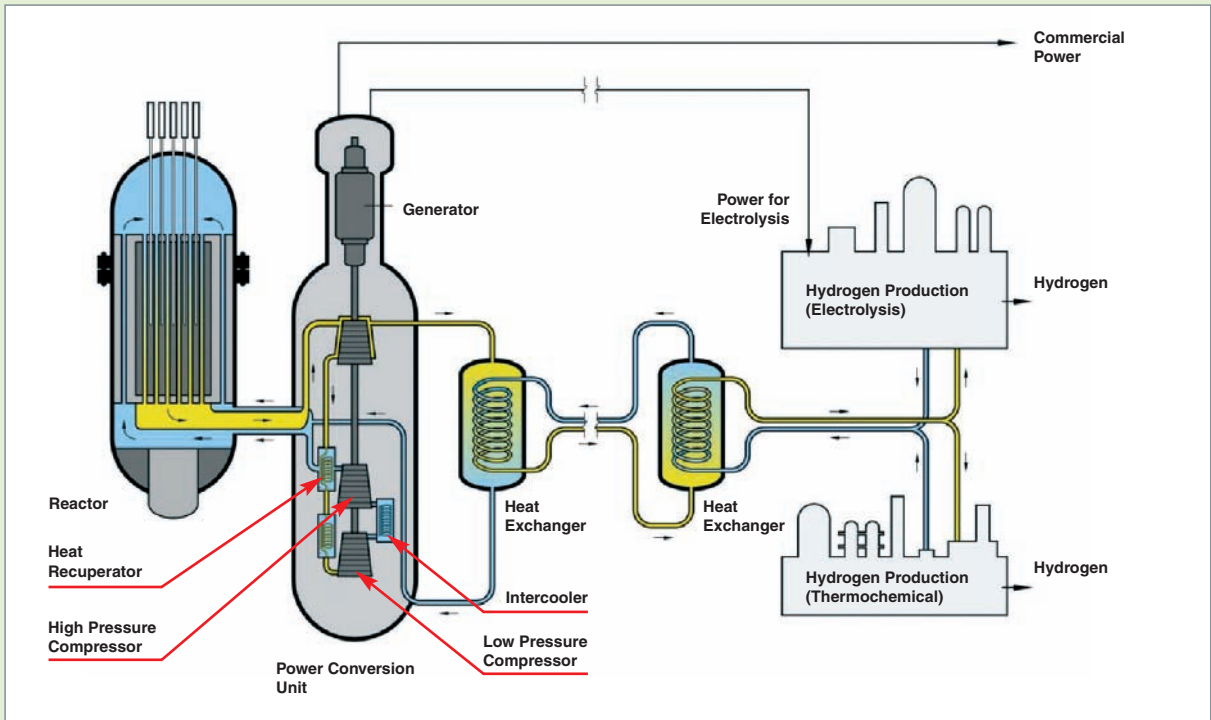

Fig. 61. Basic diagram of the NGNP.

As can be seen, the race to achieve very high temperatures opens new applications for nuclear energy. The sections that follow describe the research to be conducted and the techniques to be developed to ensure the success of such applications.

► References

[1] F. H. SOUTHWORTH *et al.*, "The Next Generation Nuclear Plant (NGNP) Project", Global 2003, November 16-20, ANS (2003), p. 276-287.

Pascal ANZIEU,

Nuclear Development and Innovation Directorate

Materials for Very High-Temperature Reactors (VHTRs)

The coolant inlet temperature of VHTRs will be close to 450 °C, and the outlet temperature will exceed 950 °C. The reactor vessel will be maintained at the coolant inlet temperature and will be composed of a material with high thermal creep resistance and good structural stability throughout the reactor lifetime (*i.e.*, 60 years). The various components of the reactor coolant system (**hot duct***, intermediate heat exchangers, turbine blades and disks) will be exposed to a temperature of 950 °C, with more or less severe mechanical loads and the need for good resistance to environmental effects produced by oxidizing impurities in the helium. The rods and guide tubes will be the only elements exposed to both high temperatures and non-negligible irradiation doses.

High temperature and pressure-resistant reactor vessel steels

The chemical composition of 9Cr steels has been progressively optimised to improve their creep resistance, namely by combining 9Cr-1Mo alloy steels with carbide-forming elements (T 91, 9Cr-1Mo VNb or T 92, 9 Cr-0.5MoWVNb). These steels have a tempered **martensitic*** structure. Their metallurgical characteristics generally provide a good tradeoff between toughness and creep resistance, with the latter strongly depending on the **austenitizing*** and tempering temperatures and **tempering*** time [1].

These steels have an excellent resistance to neutron irradiation, with high microstructural stability and **toughness*** under the typical irradiation conditions of thin core structures in SFRs

(*i.e.*, temperatures of 400 to 550 °C, pressures of up to ~100 **dpa***, and exposure times of several years). Under such conditions, the fragile-ductile transition temperature of martensitic 9Cr-1Mo and T91 steels is hardly affected by fast neutron irradiation, which is not the case with 12Cr or two-phase ferrite-martensitic 9 Cr-2Mo-VN steels.

At lower and higher temperatures, the experience feedback from the CEA and available literature for these steels shows a high stability under thermal aging. However, a few uncertainties remain for very long periods (approximately 40 years) comparable to the vessel lifetime considered for VHTRs.

At temperatures below or equal to 450 °C, the only significant metallurgical evolutions are associated with the α/α' demixtion process (which causes the germination of α' type nanometric precipitates within the α matrix). Such evolutions have been detected and analyzed through small-angle neutron scattering experiments conducted in collaboration with the Léon Brillouin Laboratory (Material Sciences Division) [2].

The effect of the nominal chrome content has been properly quantified. A threshold chrome content in solid solution of 7 to 8% has been derived for aging temperatures of 300 to 400 °C. Below this threshold content, the phenomenon does not occur (Fig.62). The volume fraction of this fine precipitation is reduced in 9 Cr steels and its impact on mechanical properties is limited to a slight hardening of the matrix without significant evolution of the toughness.

Steels	Cr	W	Mo	Ta	V	C	Nb	Cr content initially in solid solution (%)	Fraction α' (%)
HT9	11.8	0.51	0.99	-	0.29	0.21	<0.02	10.2	0.8
LA4ta	11.08	0.72	-	0.07	0.23	0.142	-	10.2	0.8
MANET II	10.37	-	0.58	-	0.21	0.1	0.016	9.2	0.3
LA12LC	8.92	0.73	-	0.01	0.3	0.089	-	8.5	0.05
LA13Ta	8.39	2.79	-	0.09	0.24	0.179	-	7	0
F82H	7.47	1.96	-	0.023	0.15	0.087	-	7.1	0

Fig. 62. α' phase fraction after exposure to 0.8 dpa at 325°C, as a function of the Cr content initially in solid solution in the matrix. Neutron irradiation accelerates the α/α' demixtion process in the steels studied (through oversaturation of vacancies) [2].

At temperatures greater than or equal to 500 °C, apart from precipitate coalescence and matrix restoration phenomena resulting in material hardening, heterogeneous Laves-type intermetallic phase precipitation phenomena are characteristically observed, preferentially localized at the various interfaces of the tempered martensitic structure. This precipitation, associated with the molybdenum and/or tungsten content of the material, has a relatively limited impact on the residual ductility/toughness of the aged material as long as the Mo (or W) content does not exceed a mass fraction typically of 0.5 to 1%.

We need to remain cautious before extrapolating these results to very long periods based on typical in-service reactor operating times (typically several tens of years). For example, very long-term creep data (~ 100,000 hours) from R&D on conventional thermal plants (turbine rotors, bolts) has shown the occurrence of a new precipitate phase, referred to as phase Z (V and Nb carbon nitride), at 500 to 550 °C. This type of phase only seems to occur after several tens of thousands of hours of aging, and a simple extrapolation of experience feedback for shorter aging times may be subject to caution. In any case, an adequate “monitoring plan” must be drawn up with regard to the possible use of 9 Cr steel for such applications in the future.

These positive aspects must be weighed against the limited knowledge concerning the use of large thickness of martensitic 9Cr steel. The following R&D themes will be particularly important:

- Fabrication of large thicknesses¹⁵: The following will need to be assessed as a function of thickness and thermochemical treatments applied: microstructural heterogeneity, distribution of initial properties in the thickness, and evolution of these properties under thermal aging, with particular emphasis on creep properties;
- Assembly processes: Validation of a high thickness welding method, and optimisation of filler metal and welding parameters to prevent the risk of high-temperature cracking (Fig. 63);
- The control of high-thickness welding and fabrication processes is a major technological challenge for the construction of the reactor vessel. Assessment results for in-service resistance under all normal and accident conditions impose the need to control thermal aging, particularly in the very long term. Given the service times and temperatures considered (60 years), thermal aging may cause variations of certain properties (creep resistance in particular), as indi-

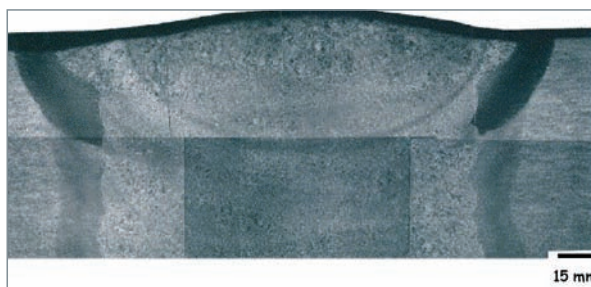

Fig. 63. Macrography of a narrow-groove TIG* joint with high-thickness filler metal (150 mm) fabricated by Framatome in its Chalon Saint Marcel plant.

cated by experience feedback. It may be possible to establish a negligible creep effect through optimisation of thermo-mechanical treatments, control of thermal aging and reduction of operating constraints.

Very high temperature-resistant materials for the reactor coolant circuit and turbine blades and disks

Various classes of metallic materials are considered for components exposed to temperatures of at least 850 °C. These components all require high thermal stability and corrosion resistance over long periods, and some of them must also be creep resistant under high stresses. The metallic materials considered are Ni-Cr and Fe-Ni-Cr superalloys with various strengthening mechanisms [3].

Solid solution and carbide-hardened superalloys

These materials are considered for the parts subject to least mechanical stress (internals, piping, heat exchangers). They are all fabricated by forging and available in sheet or tube form, with controlled welding parameters. They are susceptible to embrittlement by aging at high temperatures (carbide precipitation) [Fig. 64]. The main grades selected are listed in the table below.

All of these materials are susceptible of forming protective oxide layers in oxidizing media at high temperatures (Fig. 65). The alloy elements (even minor) significantly affect the formation and properties of the oxide layer. In the presence of helium loaded with impurities circulating in a VHTR, this protective layer may become unstable. Two risks may then occur: internal decarburization (causing a decrease in mechanical resistance) or, on the contrary, carburization (causing embrittle-

15. In Europe, only one thick 9 Cr steel plate has been manufactured to date, within the scope of the European Fast Reactor project (EFR) in the 1980's.

Characteristics of a few solid solution-hardened superalloys

Grade	Max. usage temperature*	Comments
Fe 32Ni 21Cr	800-850 °C	Least mechanically resistant grade
Ni <3Fe 22Cr 12Co 9Mo	920-950 °C	Problem with high cobalt content (possible activation)
Ni 18Fe 22Cr 1,5Co 9Mo 0,6W	920-970 °C	Risk of dynamic crystallization
Ni <3Fe 22Cr 2Mo 14W 0,1Co	To be determined	Lack of data on corrosion resistance

* With regard to corrosion.

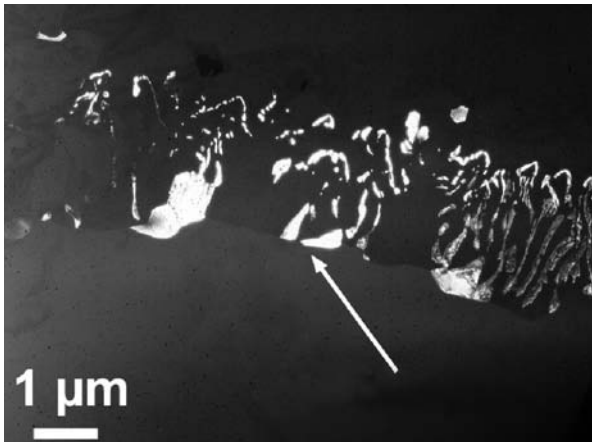

Fig. 64. Carbide precipitation in a superalloy (Haynes 230).

ment). These phenomena are strongly dependent on the H_2O , H_2 , CH_4 and CO contents of the gas, and on the temperature and characteristics of the material.

An initial series of corrosion tests have been conducted in the CORALLINE facility to characterize the material interactions with this type of environment at 950 °C. This approach will be pursued to determine the behavior laws.

It is essential to study the material evolution phenomena, whether due to VHTR environmental factors or temperature alone, and their impact on mechanical behavior so as to dimension the components for very long periods of use. Some of these materials must be characterized as creep resistant at 950 °C.



Fig. 65. Cross-sectional view of Inconel 617 (Ni <3Fe 22Cr 12Co 9Mo) after 813 hours of exposure at 950 °C to helium containing 200 vppm H_2 , 50 vppm ^{16}CO and 20 vppm CH_4 . A chromium oxide surface layer containing Ti and internal intergranular oxidation of the aluminum (initial content: 1.26%) can be observed. A carbide-free area subjacent to the surface is also observed, as well as inter and intragranular carbides closer to the core.

γ' or γ'' phase precipitation hardened superalloys

These alloys have been developed for gas turbines. They exhibit excellent mechanical properties between 650 and 750 °C due to the presence of a very large number of γ' or γ'' precipitates. These precipitates disappear beyond 750 °C, which limits the usage temperature of these alloys. They are fabricated by conventional casting/forging, or using powder metallurgy methods. The following alloys are considered for the manufacture of cooled turbine disks:

Characteristics of a few gamma phase precipitation hardened superalloys

Grade	Max. usage temperature	Fabrication method	Comments
IN 718	650 °C	Casting / forging	Controlled manufacture for large-diameter disks
Udimet 720	750 °C	Casting / forging	Satisfactory mechanical properties, but large dimensions cannot be achieved
		Powder metallurgy	Material currently being developed – Promising mechanical properties (equivalent to conventional forging)

16. Vppm = volume part per million.

Oxide dispersion hardened superalloys

These alloys exhibit excellent mechanical properties at very high temperatures (beyond 1,000 °C), as well as good oxidation and corrosion resistance. Unfortunately, their highly complex fabrication and poor weldability only allow them to be used for parts with simple geometries. Fe 19 Cr 5,5 Al 0,5 Ti 0,5 Y₂O₃ is considered for manufacturing the indirect cycle VHTR gas exchanger.

Carbon-carbon composites

The use of carbon/carbon composites is proposed for the following components in future VHTRs: control rods and guide tubes, hot duct thermal insulation, core support and closure head insulation, and upper core support blocks. Among these components, only the control rods and guide tubes are subject to non-negligible irradiation.

Fiber categories, fabrication methods and properties

Carbon/carbon composites consist of randomly arranged or woven carbon fibers (preform) and a carbon matrix. Their properties are dependant on these two components and the fiber/matrix interface.

Carbon fibers are produced by thermal decomposition of carbonated precursors and classified into three categories: ex-PAN (PolyAcryloNitrile), ex-pitch and ex-rayon fibers. They can be long, short (6 to 13 mm) or ground (300 μm). The elementary fibers or filaments ($\phi = 5$ to 10 μm) are stabilized by oxidation, thermally treated (carbonization or graphitization, depending on the mechanical properties sought), surface treated (to improve the fiber/matrix bond) and greased with a polymer (to increase their wettability). Ex-PAN fibers have a folded radial microstructure and exhibit no three-dimensional crystallographic order over large distances. Ex-pitch fibers have more varied microstructures (radial, folded radial, flat layer, onion skin, or random). However, whatever the microstructure in the transverse plane, the graphene planes tend to align parallel to the longitudinal axis of the fiber (all the more so due to the high thermal treatment temperature). Young's modulus is determined by the orientation of the graphene planes parallel to the axis of the fiber, and therefore by the thermal treatment temperature. The rupture stress is associated with the axial and radial microstructure of the fibers, and with the presence of defects. Carbon

fibers have much lower resistance to compression stress than to tensile stress. Ex-PAN fibers exhibit a tensile rupture stress of up to 7 GPa, whereas that of ex-pitch fibers does not exceed 4 GPa. Carbon fibers have an expansion coefficient equal to zero (or even negative) at temperatures up to 700 °C in the longitudinal direction, and comprised between 10 and 30 10⁻⁶ °C⁻¹ in the transverse direction. Their thermal conductivity is lower than that of metals and increases with fiber graphitization. It is greater for ex-pitch fibers (100 to 1,000 W.m⁻¹.K⁻¹) than for ex-PAN fibers (< 100 W.m⁻¹.K⁻¹).

There are different types of fibrous architectures (1D, 2D, 3D, nD), manufactured using strands of dry fibers or pre-impregnated with thermosettable or thermoplastic resin. The fabrication methods come from the textile industry (weaving, braiding, knitting, winding, pultrusion, needling). Only braiding and needling techniques can be used to obtain 3D structures.

There are three carbon/carbon composite densification methods: thermosettable resin impregnation, pitch impregnation, and chemical vapor infiltration (CVI). The choice of method depends on the geometry of the component to be densified (CVI is used for fine components, pitch or resin impregnation for thick components).

Carbon/carbon composites exhibit an excellent relationship between mechanical properties and density, good resistance to thermal shocks, and a low thermal expansion coefficient along the longitudinal direction of the fibers. They withstand temperatures of 3,000 °C in a non-oxidizing atmosphere and their mechanical properties improve with temperature, as shown in the following example of two felt-type carbon/carbon composites (ex-pitch and ex-PAN fibers) impregnated with pitch and graphitized at 3,000 °C.

The mechanical properties of two carbon/carbon composite fibers improve with temperature			
		Pitch-fiber C/C composite	PAN-fiber C/C composite
Density (g/cm ³)		1.68	1.77
Young's modulus E (GPa)	20 °C	13.5	26.3
	800 °C	18.5	27.5
	1,600 °C	25	35.6
	2,400 °C	23	33.8
Tensile stress σ_t (MPa)	20 °C	35	55.4
	800 °C	38	65.4
	1,600 °C	44	75.6
	2,400 °C	62.7	83
Toughness KIC (MPa.m ^{1/2})	20 °C	2.16	3.41
	800 °C	2.82	3.58
	1,600 °C	4.64	6.75
	2,400 °C	5.30	12.9

Nevertheless, the behavior of these composites in accident situations with air/steam inlet remains to be verified.

Effects of irradiation

Neutron irradiation causes a displacement of interstitial carbon atoms between two graphene planes, leaving vacancies in these planes¹⁷.

For the elementary fiber, this results in structural changes such as an increase in inter-reticular distance (d_{002}), a corresponding decrease in crystallite size along the crystallographic axis c (L_c), and increased disorientation of the graphene planes with respect to the longitudinal direction of the fiber. These structural changes depend on the irradiation temperature and fluence rate received. The elementary fiber will therefore contract lengthwise under irradiation. Depending on its diameter, it first contracts and then expands as a function of the **fluence*** rate. The dimensional variations of the C/C composites are governed by the behavior of the fibers. Neutron irradiation therefore causes contraction of the composites along the direction parallel to the fibers, and swelling along their perpendicular direction. The dimensional variations of 3D composites are more isotropic and less significant than those of 2D and 1D composites.

Young's modulus in the direction of the fibers increases under irradiation up to 2 **dpa***.graphite. Under the same irradiation conditions, it increases more for ex-pitch fiber composites than for ex-PAN fiber composites. At equivalent received fluence, this increase is greater when the irradiation temperature is low (between 600 and 1,000 °C). The rupture stress and toughness increase under irradiation up to 4 dpa.graphite between 600 and 1,000 °C. However, for certain composites, the rupture stress reaches a peak value at approximately 1 dpa.graphite. This is explained by a weakening of the fiber/matrix interface.

The degradation of thermal conductivity under irradiation begins at neutron damage levels as low as 10^{-3} dpa.graphite and is due to vacancies and vacancy loops. The normalized thermal conductivity $(\lambda_i/\lambda_0)_{Tirr}$ increases with the irradiation temperature.

The thermal conductivity decreases as the fluence rate increases. Within the irradiation temperature range of 400 to 1,200 °C, the ratio λ_i/λ_0 is a logarithmic function of the neutron damage. Saturation of the degradation of thermal conductivity occurs at 0.2 dpa.g for an irradiation temperature of 200 °C, whereas it is observed at 2 dpa.g for an irradiation temperature of 600 °C.

Variation of the thermal conductivity of a C/C composite, as a function of the irradiation temperature		
	$(\lambda_i/\lambda_0)_{Tirr}$ C/C composites irradiated at 1 dpa.graphite	
Irradiation temperature (°C)	High λ_0 ($> 150 \text{ W.m}^{-1}.\text{K}^{-1}$ à 25 °C)	Low λ_0 ($< 150 \text{ W.m}^{-1}.\text{K}^{-1}$ à 25 °C)
400	0.30/0.35	0.30/0.35
600	0.55/0.60	0.60/0.65
800	0.75/0.80	0.85/0.90
1,000	0.80/0.85	0.95/1
1,500	1	1

Ductile ceramics with good heat conducting properties and resistance to irradiation damage

Monolithic ceramics are natural candidates for high-temperature resistance. Unfortunately, they generally have an extremely low **toughness***, $\sim 1 \text{ MPa m}^{1/2}$, *i.e.*, one order of magnitude lower than that of a ferritic steel during low-temperature cleavage. Rupture energies vary with the square of the toughness. Therefore, there is an essential need for a tough ceramic. Two complementary possibilities can be considered to improve the toughness and ductility of ceramics: the use of composites, allowing for controlled damage prior to rupture and generally leading to significant increases in toughness, and nanostructuring, particularly of submicronic grain sizes, which should improve **ductility*** in the thermal creep domain due to the activation of controlled creep mechanisms through vacancy diffusion.

SiC fiber-reinforced matrixes are widely used in the space field for high-temperature applications. The mechanical properties depend on the fibers used, the matrix, and the fiber/matrix interface. The latter is essential for improving toughness by increasing the crack propagation path. However, a compromise must be found with regard to thermal conductivity. An interface that improves toughness very often leads to a degradation of thermal conductivity. As for the fibers, they ensure a significant portion of the mechanical resistance. Ceramic fibers with a ductility of approximately one percent at high temperatures are already commercially available. The creep mechanism of these fibers has been studied in detail at the LTCS (mixed laboratory, CEA-CNRS-SNECMA-University of Bordeaux). For temperatures above 1,150 °C, commercial SiC β fibers (Tyrano SA3 and Hi Nicalon S) show a creep rate stress dependence of $\sigma^{2.5}$, but significantly different activation temperatures, as shown in Figure 66. These results clearly demonstrate the importance of impurities or dopants in the thermal creep behavior of these fibers.

17. For more details, see *supra*, p.27.

A toughness of approximately a few tens of $\text{MPa}\cdot\text{m}^{1/2}$ has been obtained in this type of material, which is already a significant improvement as compared to monolithic ceramics. An acceptable compromise between high toughness and reasonable creep resistance is therefore achievable, possibly leading to the use of composite ceramics in future VHTRs.

Material nanostructuring provides another possibility for improving the mechanical characteristics of ceramics. Laser pyrolysis is a flexible nanoparticle synthesis method that can be used to produce highly pure nanometric powders in continuous flux. This technique is based on the decomposition of a liquid or gas precursor by a high-power laser beam emitting at a wavelength resonating with the absorption band of the precursor molecules. The very short interaction time between the precursor flux and the laser beam intercepting it produces a very rapid quench phenomenon that blocks the grain growth initiated by the beam. A grain size ranging from 5 to 100 nanometers is obtained, depending on the materials considered and the synthesis conditions.

Among the numerous compounds that can be synthesized using this method, refractory metallic carbides such as TiC and ZrC exhibit interesting properties for use as ceramics in future nuclear reactors. They can be produced by laser pyrolysis of metallic alkyls (inexpensive and easy to use). The

powder collected at the reactor outlet consists of a mixture of TiO_2 (or ZrO_2) and free carbon whose proportions can be controlled to obtain a stoichiometric carbide (after simple thermal treatment in neutral gas atmosphere).

In order to benefit from the innovative characteristics of nanoparticles, associated with their reduced dimensions (less irradiation damage), it is extremely important to control the grain growth during powder synthesis or treatment and during the **sintering*** process. As a result, sintering processes with very short high-temperature plateaus and rapid temperature increase rates appear to be most appropriate. The other crucial point regarding nanopowder sintering is the densification of the final pellet.

Figure 67 shows an electron scanning microscopy image of a nanostructured TiC ceramic sintered under 8 GPa at 1,800 °C for 2 minutes at the (HPRC, Warsaw). The inserted image shows the nanopowder produced before sintering (CEA Material Sciences Division, Atomic and Molecular Physics Department). During the sintering process, a densification rate of 93% is achieved without sintering additives. We note the absence of grain growth during this process. These results are encouraging, but the mechanical behavior and stability of the nanostructure still need to be studied.

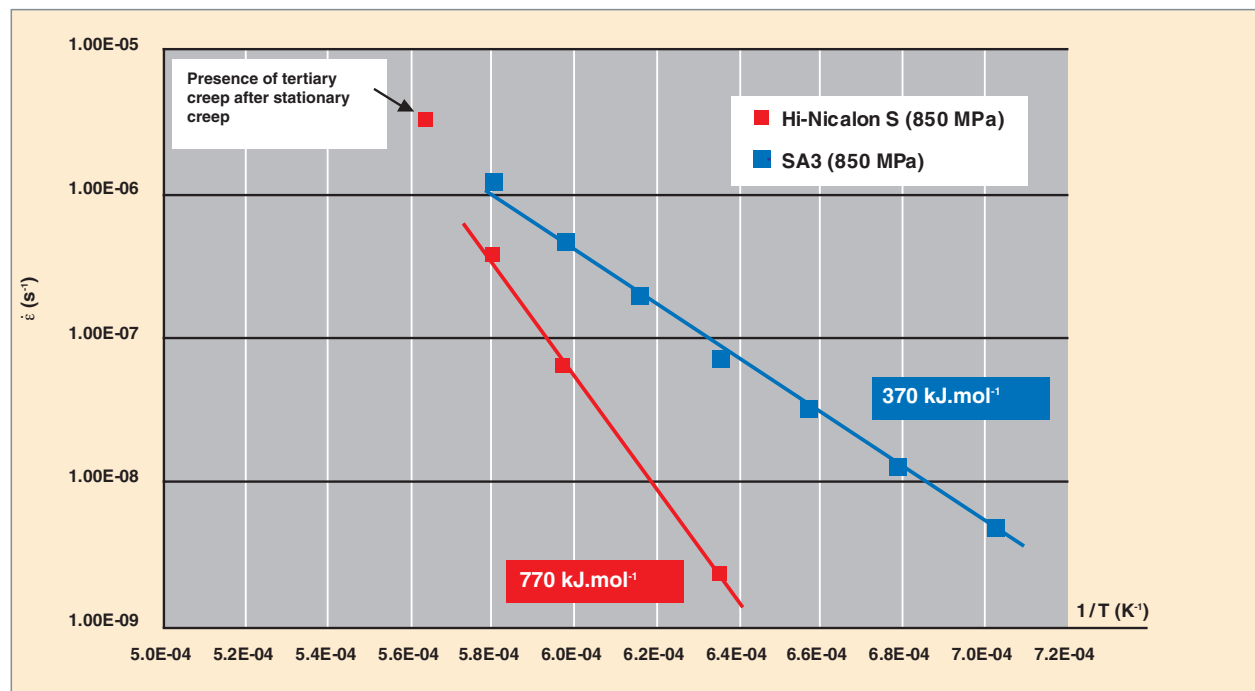

Fig. 66. Activation energy of the secondary thermal creep rate for two commercial SiC β fibers: Tyrano SA3 and Hi Nicalon S. For the SA3 fiber, the activation energy is close to the self-diffusion energy

of the free carbon present near the grain joints. For the Hi Nicalon S fiber, the activation energy is close to the diffusion energy of the aluminum used as a sintering additive in the fabrication process.

Conclusion

The selection of VHTR core materials is a process that has just begun. It will probably lead to various compromises, depending on the properties sought. The materials selected will need to exhibit good mechanical resistance, combined with sufficient toughness and thermal conductivity throughout the component lifetime. Various strategies for material improvement are actively pursued. One of the most promising is the use of composite materials. Another is to control the structure of alloys or ceramics at the nanometric scale.

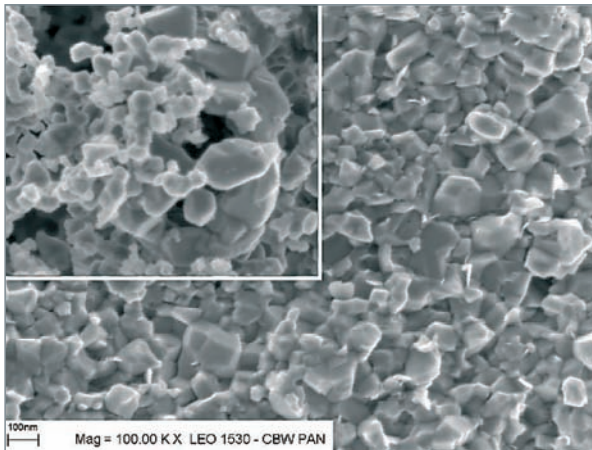

Fig. 67. Nanostructured TiC ceramic and nanometric powder.

References

- [1] F. MASUYAMA, "New Developments in Steels for Power Generation Boilers", in *Advanced Heat Resistant Steel for Power Generation*, Edited by R. Viwanathan and J. Nutting, Pages 33-48, Conference Proceedings, April 27-29, 1998, San Sebastian, Spain, The University Press Cambridge.
- [2] A. ALAMO, X. AVERTY, Y. DE CARLAN, G. GEOFFROY, M. H. MATHON and C. H. DE NOVION, "A SANS investigation of the irradiation-enhanced α - α' phases separation in 7-12 Cr martensitic steels", *Journal of Nuclear Materials*, Volume 312, Issues 2-3, February 2003, Pages 236-248.
- [3] "Properties of Superalloys, in *Heat Resistant Materials*", ASM Specialty Handbook, Edited by J.R. Davis, 1999, Pages 219-335.

Jean-Louis BOUTARD,

Simulation and Experimental Tools Directorate

Hélène BURLET,

Technological Research Division

Cécile REYNAUD,

Material Sciences Division

Anne TERLAIN,

Physicochemistry Department

Bernard MARINI, Jean-Claude BRACHET

& Jean-Pierre BONAL,

Nuclear Materials Department

Advanced fuels and new ceramics for very high temperatures

The achievement of temperatures exceeding 850 °C is a minimum objective for HTRs. For example, the core outlet temperature of the Japanese experimental VHTR has just been increased to 950 °C, further to modification. Temperatures of 950 °C had already been attained by the German AVR in 1983-85, under very good conditions, particularly with regard to fission product retention by the fuel. The fuel used consisted of **TRISO*** UO_2 or $(\text{Th,U})\text{O}_2$ particles conditioned in pellets approximately 6 cm in diameter, with a nevertheless limited specific core power, in the order of 2.5 to 3 MWth/m³ [1].

As previously described, future reactor systems call for higher outlet temperatures. Temperatures of 1,000 °C could be attained or even exceeded in the medium term via technological breakthroughs in materials. The same applies to the power density, the objective being to build units with the highest possible power within a given volume (*i.e.*, a metallic reactor vessel).

Although the particle fuel design remains the same for HTRs and VHTRs, the combination of increased temperature and power density and the pursuit of higher burn-ups affect the fuel in two ways: higher maximum temperature and higher thermal gradients.

This leads to various consequences:

1. The risks of fission gas release by the core are increased.
2. The production of CO and CO₂ carbon oxides due to the reaction of the carbonated layers surrounding the oxide fissile core with the oxygen atoms released by fission increases with the burn-up.
3. The mechanical balance of the layers and its evolution with time are modified by the presence of internal pressurization due to the gases confined in the particle, and also due to the creep and densification behavior of the **pyrocarbons*** (PyC), which depends on the temperature.
4. The diffusion of species is significantly increased by the temperature level, particularly in the case of carbon and fission products.
5. The damage margins for the fission product barrier constituted by the dense **silicon carbide*** layer are reduced (particularly in accident situations), whereas the inventory to be confined increases with the burn-up.

TRISO fuel is already almost satisfactory for VHTRs. However, despite past demonstrations of good behavior at high temperatures, the amoeba effect (Fig. 68) and/or the diffusive migra-

tion of certain fission products limit this fuel's performance. An improved fuel is therefore sought for VHTRs.

Two modifications of the particle fuel are proposed in order to find solutions to the amoeba effect and recover the temperature margins in accident situations (point 5 above).

The uranium oxycarbide compound referred to as UCO (actually a $\text{UO}_2\text{-UC}_2$ biphasic mixture) is proposed as a replacement to simple oxide for the fuel particle cores. The fact that the carbon present in the core limits the production of carbon oxide in the highly porous medium surrounding the core is taken into account ($\text{UC}_2 + 2\text{CO} \leftrightarrow \text{UO}_2 + 4\text{C}$), with a favorable impact on the pressurization of this medium (and the mechanical stresses of the dense containment barrier). The coexistence of two phases should also reduce gas-phase carbon transport phenomena and thereby impede the amoeba effect. Such favorable impacts have been demonstrated in the past, even though the mechanisms involved are not fully understood. The $\text{UO}_2\text{+UC}_2$ mixture is the least innovative solu-

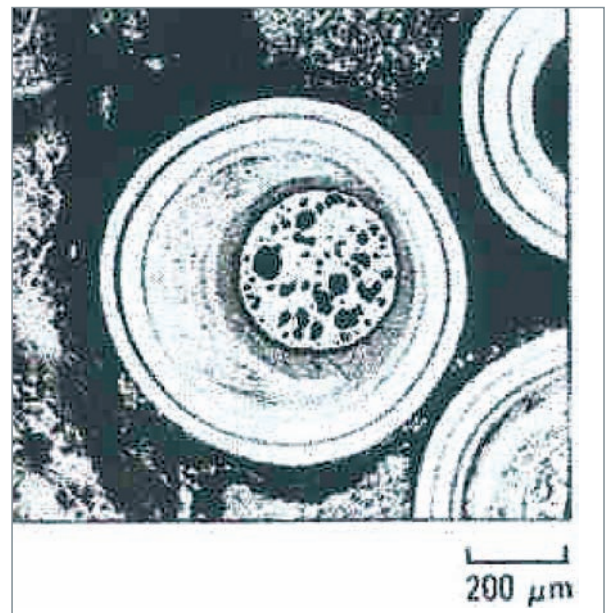

Fig. 68. Amoeba effect observed in coated particle fuel at high temperature. It consists of a displacement of the UO_2 core in the porous buffer until contacting the internal PyC, possibly leading to rupture of the particle.

tion conceived, particularly with regard to fabrication, but other materials have also been proposed and tested.

Prior to the controlled fabrication and use of oxycarbides, it is essential to determine the U-O-C ternary phase diagram. The CEA has built a thermodynamic database using (U-O) and (U-C) binary models and optimised ternary interaction parameters to represent the experimental data available in the field of oxycarbide composition. An analysis of missing experimental data has been conducted (oxygen solubility limit in uranium dicarbide, temperature of occurrence of oxygen-stabilized dicarbide, oxycarbide activity and/or enthalpy data) and an experimental has been initiated (based on high-temperature mass spectrometry).

The Figure 69 show the results of this work in the form of isotherm cross-sections.

Zirconium carbide could replace silicon carbide as the fission product barrier. It has a low neutron absorption cross-section (although higher than that of SiC) and a significant density. ZrC displays non-congruent fusion. It melts at 3,540 °C, but it decomposes by peritectic fusion at 2,545 °C, producing graphite and a liquid with a carbon content of 27% (fig. 70). Sublimation begins at approximately 1,800 °C and becomes significant at temperatures above 2,000 °C (in neutral or reducing atmosphere).

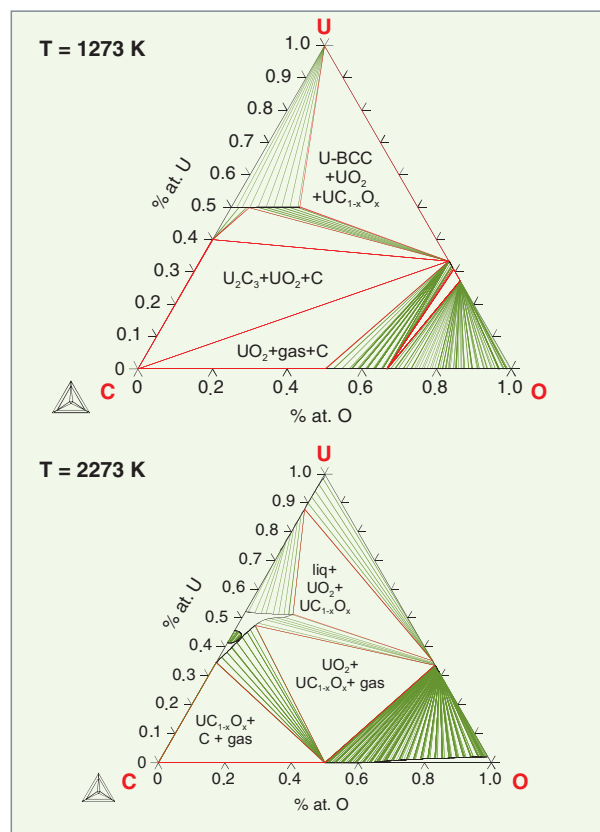

Fig. 69. Calculated U-O-C isotherms.

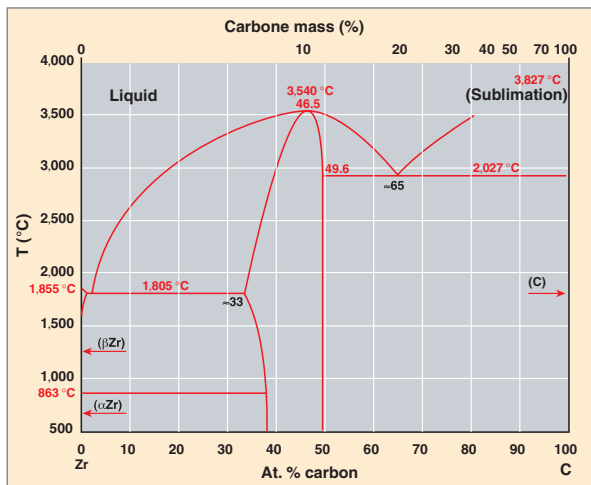

Fig. 70. Zr-C phase diagram.

ZrC therefore provide a clear margin with regard to the 1,600 °C maintained for a few tens of hours representing the design basis accident situation and during which the release of radiotoxic elements must remain very low. It may also provide the following, at equal temperature:

- Chemical resistance to palladium (fission product) clearly better than that of SiC, which reacts significantly and is subject to a corrosion process. It has been demonstrated that ZrC remains intact in the presence of vapor-phase palladium at temperatures of up to 1,900 °C [2].
- Increased retention of cesium, strontium, barium, iodine, xenon and krypton.
- Theoretically better retention of silver, one of the most mobile elements in SiC [3].
- Certain research results have also shown that, in addition to serving as an efficient barrier, ZrC may act as an oxygen trap ($2CO + ZrC \rightarrow ZrO_2 + 3C$) and thereby produce a favorable impact on the oxide core amoeba effect [4].

Palladium and silver retention provides significant benefits. This highly positive analysis must nevertheless be weighed against two factors. On the one hand, certain fission products are less well retained (ruthenium and cerium [5]) and, on the other hand, the oxidation behavior of ZrC is less favorable than that of SiC, which comprises a protective silicon layer. This factor is to be taken into account in certain degraded situations or at the back end of the cycle.

ZrC deposition is performed using a conventional vapor phase deposition method with a mixture of zirconium tetrachloride and carbon precursors (propylene and methane diluted in hydrogen). It is performed on a fluidized particle bed heated

to approximately 1,300 °C (Fig. 71). The current experimental results are encouraging, but there is still room for improvement in terms of porosity and stoichiometry (Fig. 72).

These evolutions in TRISO particle materials must clearly undergo additional research to optimise the particle design and improve the fabrication and control methods. The specification of the UCO polyphase compound and the definition and control of the ZrC stoichiometry need to be refined. Finally, we need to acquire additional data on the behavior of fission products in UCO and ZrC to consolidate our understanding of their migration mechanisms [6] and confirm their good behavior under irradiation.



Fig. 71. Chlorinator used to synthesize zirconium tetrachloride (Zr precursor in the vapor phase ZrC deposition method) from Zr powder attacked with HCl.

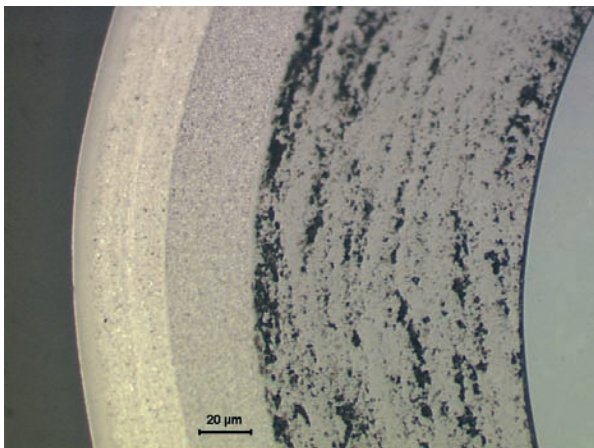

Fig. 72. Cross-section of ZrC deposition performed at the CEA on simulator cores composed of pyrocarbon-coated zirconium.

► References

- [1] A. W. MEHNER, H. NABIELEK, H. NICKEL, G. POTT, "Long time experience with the development of HTR fuel elements in Germany", *Nuclear Engineering and Design*, 217 (2002), Pages 141-151.
- [2] K. MINATO, T. OGAWA, "Research and Development of ZrC-coated Particle Fuel," *Proceedings of Global 2003 (ANS, New Orleans, November 16-20)*, p. 1068.
- [3] A. S. CHERNIKOV *et al.*, "Fission products diffusion in fuel elements materials for HTGR", *Proc. IAEA Specialists meeting on fission products release and transport in gas cooled reactors*, Berkeley, October 22-25, 1985, IAEA IWGGCR/13, Vienna, Pages 170-181 (1986).
- [4] R.E. BULLOCK, J.L. KAAE, "Performances of coated UO_2 particles gettered with ZrC", *J. of Nucl. Mat.* 115 (1983), Pages 69-83.
- [5] J. HOMAN, D. A. PETTI, *HTR/Eurocourse 2002, Cadarache, November 4-8, 2002*, organisé par la Communauté européenne et le CEA.
- [6] H. J. MAC LEAN, R.G. BALLINGER, *Global*, 2003, p. 525.

Philippe MARTIN,

Fuel Research Department

Energy conversion in 4th generation gas-cooled reactor systems

Energy conversion in current reactors

In nuclear plants, the energy released by nuclear reactions heats the fuel elements. As in thermal plants using fossil fuels, the heat released from the reactor is transformed into electrical energy by subjecting a fluid to a **thermodynamic cycle**. The choice of this fluid, which transforms heat into work, is a structuring factor in the reactor design. All electrical nuclear reactors currently operating use water in a Rankine thermodynamic cycle, *i.e.*:

- **Constant-pressure vaporization** of the water at the heat source;
- **Expansion** of this steam in one or more turbines transforming the fluid's energy into mechanical energy, which is itself transformed into electrical power by the generator;
- **Condensation** of the low-pressure steam leaving the turbines, by heat transfer to the heat sink;
- **Compression** of the condensed water back to its initial pressure.

For a maximum steam temperature of approximately 280 °C and a pressure of 70 bar, the net energy efficiency of PWRs (ratio of the electric power output to the thermal energy released by the reactor core) amounts to around one third. This efficiency could theoretically be improved with higher steam temperatures. With the EPR (European Pressurized Reactor), Framatome-ANP's 3rd generation PWR, a net efficiency of 36% will be achieved, partly due to the increase in steam pressure. However, the nuclear fuel cladding in PWRs is in permanent contact with the liquid water of the reactor coolant system ensuring the transfer of energy. This makes it difficult to consider much higher steam temperatures in the secondary system.

It has been decided that 4th generation gas-cooled reactor systems will use **helium** to transfer heat energy from the reactor core. The good thermodynamic properties of helium constitute one of the reasons for this choice¹⁸.

With helium as the reactor core coolant*, two main options are available

First of all, the helium transporting heat from the reactor core can be used to heat the fluid in a secondary system (*e.g.*, to vaporize the water in a steam generator, as in PWRs). In this case, the energy conversion fluid is different from the fluid circulating in the reactor core. This is referred to as an **indirect cycle**. The other option is to use a Rankine cycle (or Hirn-Rankine cycle), but with much higher steam temperatures than in PWRs (550 to 600 °C), allowing a net energy efficiency of over 40%¹⁹. However, given the difficulties associated with the use of steam at very high temperatures (above 600 °C), this option does not allow us to fully take advantage of the potential of helium, with which we aim to achieve a core outlet temperature of 850 °C. This is why it has been decided to give priority to the use of **direct cycles** with helium as the energy conversion fluid, particularly the Joule-Brayton cycle, in which the helium circulating in the reactor core is sent directly to the turbine.

Joule-Brayton cycle

This cycle is well known and largely used in systems with gas turbines, including propulsion systems (aircraft, boats) and combined-cycle electric plants running on fossil fuels.

In most of these applications, a simple cycle is used consisting of the following phases (Fig. 73):

- Suction and compression of air, and transfer to a combustion chamber (1→2)
- Burning of air-fuel mixture in the combustion chamber (2→3)
- Expansion of burnt gases in a turbine (3→4)

The burnt gases are released into the atmosphere at the turbine outlet. This cycle is therefore referred to as an "open" cycle. The Joule-Brayton cycle can be conveniently represented by a temperature-entropy diagram (T, S) [Fig. 74]. Under ideal conditions, the cycle domain represents the specific mechanical work (in J/kg) delivered by the cycle. This work

18. The other advantages and disadvantages of using a helium coolant are discussed *supra*, p. 24 et 25.

19. All 1st generation gas-cooled reactors (using mainly CO₂ as coolant) took this option.

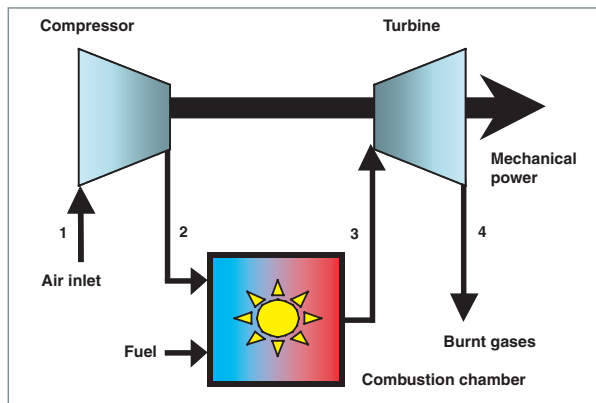

Fig. 73. Simple Joule-Brayton cycle used for an open-cycle gas turbine.

multiplied by the circulating fluid flow rate yields the power output of the system. Ideally, this cycle consists of a first isentropic phase (compression 1→2), an isobar phase (combustion 2→3) and a second isentropic phase (turbine expansion 3→4). Isobar (4→1) represents the cooling of burnt gases.

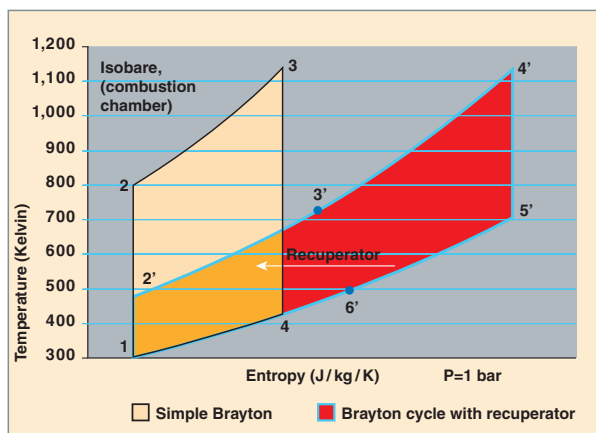

Fig. 74. TS diagrams of the Joule-Brayton cycle (with and without heat exchanger-recuperator). The numbers indicate corresponding points in Figures 73 and 75.

The energy efficiency of this ideal cycle is expressed as,

$$\eta = 1 - \left(\frac{P_4}{P_3}\right)^{\frac{\gamma-1}{\gamma}}$$

where γ is the ratio of the specific heats of the gas at constant pressure and constant volume, *i.e.*, 1.4 for air and 1.66 for helium. Under otherwise equal conditions, high expansion ratios (P_3/P_4) therefore yield the best efficiencies (since the expansion ratio is limited by the temperature at the heat source).

When the turbine outlet temperature exceeds the compressor inlet temperature, the Joule-Brayton cycle efficiency can be improved by using the turbine output gas to reheat the gas exiting the compressor, *i.e.*, by means of a recuperator-type **heat exchanger**. This heat exchanger heats the compressor

output air before it enters the combustion chamber. In comparison with the previous example, this option has the advantage of providing maximum efficiency at lower expansion ratios, thereby reducing the size of the turbomachine (Fig. 74, and TS diagram in Fig.75). A heat exchanger must be added, acting as the heat sink of the cycle. The cycle is then almost closed. In these two examples, the cycles are “internal combustion” cycles, *i.e.*, the fuel is mixed and burnt with the working fluid (air).

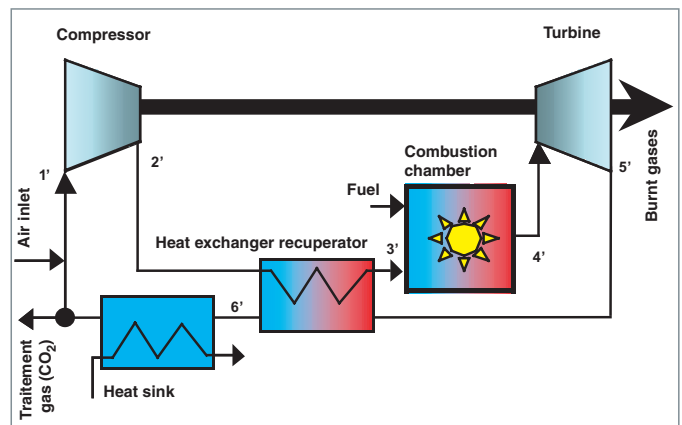

Fig. 75. Semi-open Joule-Brayton cycle with recuperator. The numbers indicate corresponding points in Figures 73 and 74.

In nuclear reactors, combustion is **external** and the thermodynamic cycle can be completely closed. The choice of gas is no longer imposed by the combustion and can therefore be based on other criteria. The basic principle remains the same as in Figure 75, except for two changes: combustion chamber replaced with nuclear reactor core, and no burnt gases to be replaced with fresh air. There are numerous possible variations of this configuration. The goal is to optimise the net efficiency and specific work of the cycle (in J/kg) without excessively complicating the design. For example, increasing the reactor core inlet temperature increases the efficiency of the cycle, but an excessive increase fixes the temperatures of various structures, particularly that of the main reactor vessel, and must therefore be avoided.

The reference cycle considered for the GCR design studies comprises not one but two compression levels, with a helium cooling circuit between the two compressors. This configuration approaches the compression isentropy by one isotherm, which provides a gain in efficiency of about 4 points for a reactor inlet temperature limited to 480 °C. The net efficiency is then 47 to 48% for a core outlet temperature of 850 °C. Additional compression levels could also be considered, at the cost of increased system complexity.

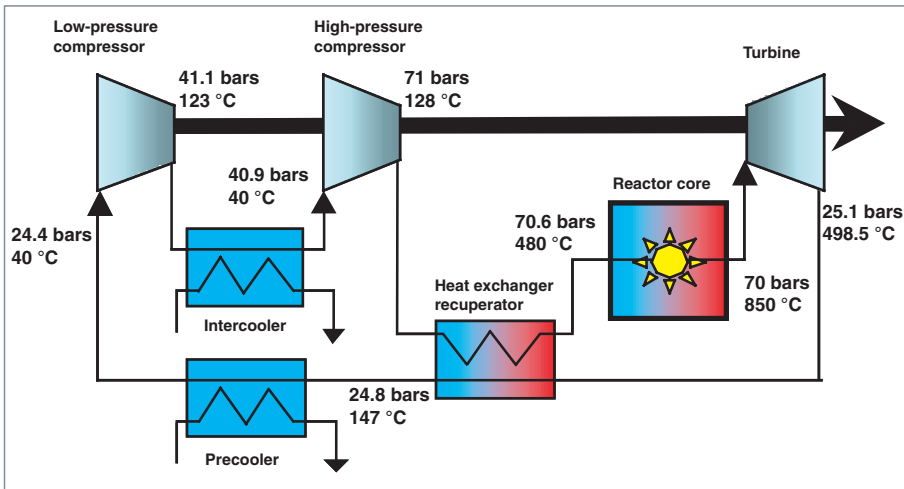

Fig. 76. Reference energy conversion cycle of the GCFR (net efficiency: 47%). The parameters have been optimised using the CYCLOP program developed at the CEA.

Figure 76 shows the main parameters of this two-level cycle, optimised using the CYCLOP program developed at the CEA.

Even though the direct helium cycle is presently the most promising concept for gas-cooled reactors, other energy conversion cycles also based on the Joule-Brayton cycle have been considered as possible alternatives. One of the most interesting consists of using supercritical carbon dioxide in an indirect cycle (still using helium as primary coolant). The maximum pressure and temperature will be approximately 250 bar and 650 °C (critical pressure for CO₂ = 73.8 bar). According to the calculations performed at the CEA, this alternative has the advantage of achieving efficiencies almost equivalent to the above-mentioned 47-48%, but with much lower core outlet temperatures (in the order of 700 °C). However, it has the disadvantage of complexity and risks of secondary system corrosion. Moreover, there is no operating feedback for a turbomachine using supercritical CO₂.

Combined cycle

A variant of the Brayton cycle with recuperator uses a turbocharger (as in the Brayton cycle) but replaces the turbine exhaust recuperator by a steam generator powering a steam turbine. This combined cycle is similar to the one intended for combustion gas turbines, except that it uses a closed gas cycle (see *supra*, Figure 26, p. 41). Efficiency is excellent, since the system benefits from the advantages of the gas cycle for high temperatures and also those of the steam cycle for low temperatures, namely due to the ability to condensate steam at the heat sink. AREVA has adopted this concept for its ANTARES project in order to avoid the technological difficulties associated with the design and construction of a helium-cooled turbocharger. The ANTARES project is based on the

implementation of an indirect cycle with an intermediate heat exchanger and a secondary circuit using nitrogen (whose properties are very similar to those of air). This concept makes use of proven air turbine and compressor technologies. AREVA adds 20% helium to the nitrogen carrier gas so as to improve its exchange properties. This has the advantage of optimising the intermediate heat exchanger design without significantly affecting the conventional turbocharger technology implemented.

Gross and net efficiencies in excess of 50 and 46%, respectively, can be

achieved, at the cost of a certain apparent complexity as compared to a Brayton cycle with recuperator. Since a proven combined cycle technology is used, this apparent complexity does not necessarily lead to a higher cost than the Brayton cycle with recuperator, which remains to be developed and whose cost is not yet known.

Moreover, this particularly flexible concept is well-suited for **cogeneration*** configurations, possibly representing most of the market for these reactors.

A few comments must be made regarding the choice of the Joule-Brayton conversion cycle using helium:

- Helium has practically never been used in high-power Joule-Brayton cycles. The only significant experience is that acquired with the Oberhausen II plant in Germany (Fig. 77) and through the tests conducted at the HHV facility. Oberhausen II was an industrial plant that operated for 24,000 hours from 1974 to 1988 (12,000 hours at 750 °C), and HHV was a lower-power test facility that only operated for 1,100 hours (350 hours at 850 °C). Regarding performance, the Oberhausen turbocompressor only achieved 30 MWe, instead of the 50 MWe planned. HHV achieved higher performance. Among the other lessons learned, we note the complexity of the sealed-oil bearing systems, leading to the construction of oil/helium separation labyrinths whose losses and vibrations were incorrectly evaluated. Moreover, the HHV facility had a long outage due to an accidental ingress of oil (under cold conditions). That is why alternative mechanisms such as magnetic bearings are now considered;
- Most of the industrial experience is with open-cycle gas turbines. As compared to closed-cycle gas turbines, they are characterized by high expansion ratios (20 to 50) and a low-pressure level imposed by ambient conditions, *i.e.*, 1 bar (therefore a high pressure of 20 to 50 bar). With a closed helium cycle, the expansion ratios are much lower (2 to 4) and the mean pressure level is "free" (and must therefore be

optimised based on various considerations, *i.e.*, heat transport properties, minimisation of pressure losses, and size of components, particularly turbomachines).

This experience situation was not immediately exploited. For closed-cycle turbomachines, projects were completed a long time ago and knowledge was often lost (German experience, for example). For fossil fuel facilities, the largest open-cycle turbines marketed have thermal powers of about 500 MWth. These machines are still rare, pose various problems, and require additional development.

The turbomachine – a crucial component of gas-cooled reactors

The use of helium (selected due to its good in-core thermal properties) imposes specific performance and technological requirements for the turbomachine, since helium is monoatomic and light. As a result, the shaft has a large diameter and the blades are short.

The questions raised by these machines are similar to those addressed in the field of aeronautics, and various collaborations have been initiated to benefit from the expertise of other authorities (Alstom, EDF, Von Karman Institute, Ecole Centrale de Lyon, Snecma-Motors, Fluorem, etc.).

In particular, a thesis study led to a “Modeling of gas turbocompressors” (N. TAVERON, ECL 2006). This two-dimensional model describes each rotor and stator of each turbomachine component for both stationary and non-stationary regimes. It can be used to generate machine performance maps based on geometric characteristics, and also to describe the operation of the compressors and turbines under specific conditions, including low and negative flow rates (*e.g.*, pumping, compressor flow inversion) [Fig. 78]

The aerodynamic design of helium turbomachines is more simple than for other fluids (flow is always subsonic), but unusual nonetheless, *i.e.*, high centrifugal stress and large number of stages (significant importance of clearances and secondary flows). The performance of such machines will therefore need to be validated through large-scale tests.

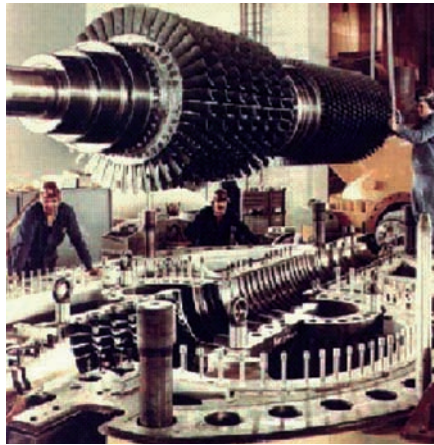

Fig. 77. High-pressure stage of the 50 MWe turbomachine for the experimental gas-cooled reactor facility in Oberhausen, Germany (helium temperature: 750 °C). In particular, we note the smallness of the second-stage blades due to the low density of helium.

The temperature resistance of turbine disk and blade materials is also an essential factor for long-term operation²⁰. These material studies will need to be based on fine calculations of fluid dynamics, associated with mechanical calculations. Certain questions remain open: Should the structures be cooled? If so, what is the impact on efficiency, the choice of materials and the associated cost?

Various other technological questions arise:

- Performance level (taking into account of clearances, estimated losses);
- Sealing of rotating parts;
- Magnetic bearings (feasibility for large machines);
- Position of turbomachine, *i.e.*, vertical position excellent for compactness, but probably less favorable for operation (should horizontal machines be preferred?);
- Vibrations (control of oscillations, balancing of masses, and alignment of various components).

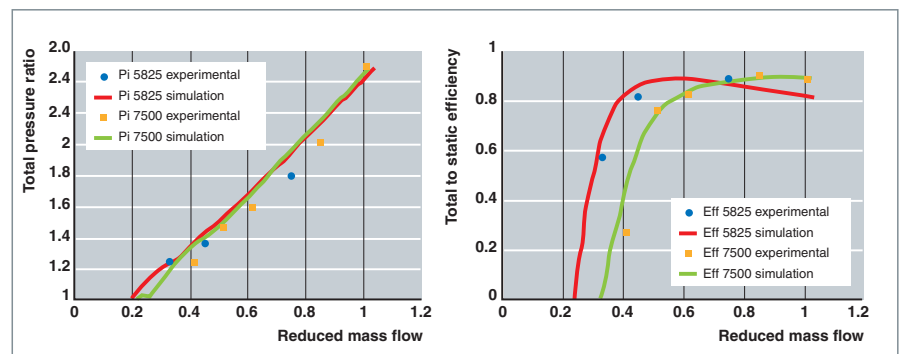

Fig. 78. CEA modeling of a turbomachine: Adimensional comparison of experimental/simulated pressure (left) and isostatic efficiency (right) as a function of mass flow rate.

Furthermore, the turbomachine will need to be considered in a nuclear context. In a direct cycle, the turbomachine and core constitute a single system, *i.e.*, the slightest change in the operating regime of one of the two affects the operation of the other. The entire system must therefore be conceived and modeled in an integrated manner, taking into account safety-related issues.

20. See *supra*, p. 77-83, on high-temperature materials.

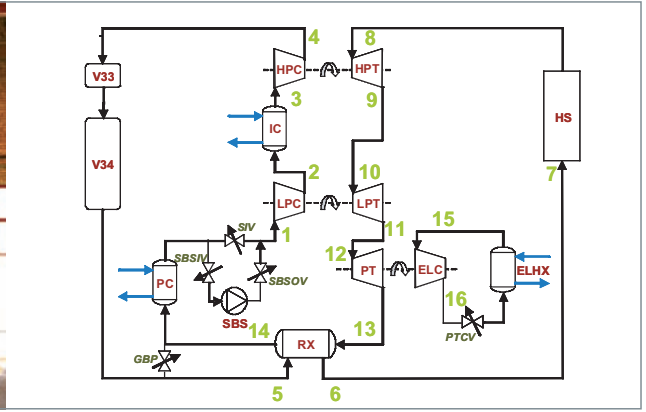
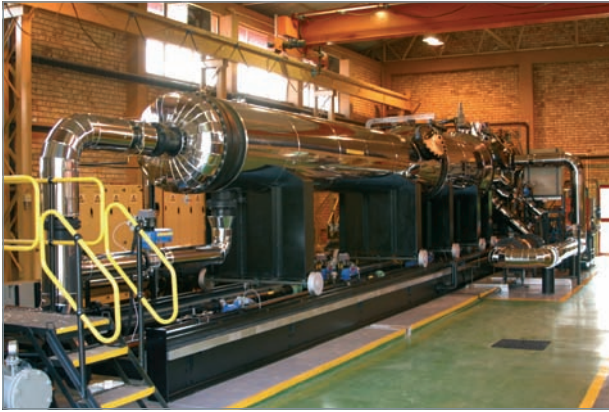

Fig. 79. South African PBMM test loop simulating the direct cycle of a PBMR (left), and representation in the CEA's CATHARE program (right).

Reactor and turbomachine: two systems coupled by thermal hydraulics*

This turbomachine model has been integrated into the CATHARE computer code used to represent all the hydraulic circuits of the reactor. An application example is shown below, corresponding to the recalculation of tests for the South African PBMM test loop, which simulates the operation of the PBMR primary system (Fig. 79). This loop comprises a Brayton cycle with air as the working fluid and three online turbocompressors. The output pressure of the high-pressure compressor (HPC), *i.e.*, the maximum pressure of the circuit, is overestimated in the CATHARE calculations. This results from an overestimate of high-pressure turbomachine performance due to the transcription of experimental data and the manner in which the characteristics of rotating machines are taken into account in the codes (Fig. 80).

The analysis of the operation and safety of a direct-cycle GCR requires a complete modeling of the thermal hydraulics of the reactor core and turbomachine, since the two systems are intimately associated and affect one another. In order to solve this essentially thermal-hydraulic problem, a multi-scale approach has been implemented, ranging from punctual models to 3D fluid dynamics. A 2D axisymmetric model developed at the CEA to calculate stationary and non-stationary turbomachine regimes can also be used to obtain an internal description of the turbomachine (thermal exchanges at walls, cooling, etc.) taking into account the geometric characteristics of the compressors and turbines. In the future, 3D fluid dynamics models taking into account true geometry should enable estimates of hot points on the blades and disks, a better prediction of cooling efficiency, and the determination of correlations to be used in global models.

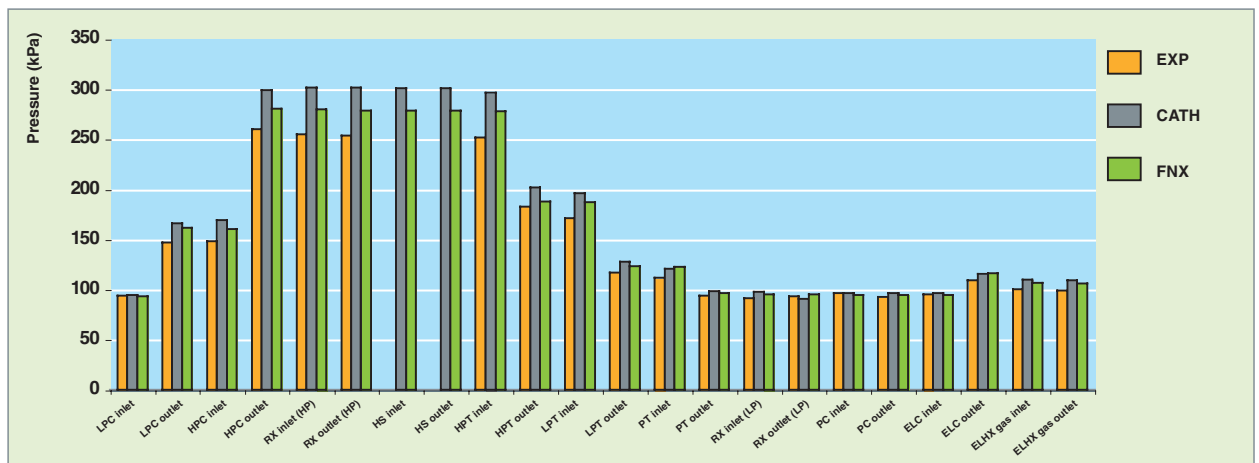

Fig. 80. Comparison of system component pressures based on calculations using the CEA's CATHARE program (grey), the South

African FLOWNEX program (green), and experimental PBMM results (orange).

Without waiting for the refinements promised by 3D fluid dynamics, a first punctual turbomachine model has been included in the CATHARE code used to model the thermal hydraulic operation of the reactor. This model allows a reasonable simulation of the stationary and transitory behavior of the reactor (the characteristic curves of each component of the turbomachine consist of input data)²¹.

Design and optimisation of energy conversion systems in cogeneration configuration

The high temperatures achieved make GCRs capable of cogeneration, *i.e.*, using part of the heat produced by the reactor for purposes other than electricity production. From a cogeneration perspective, the GCR and its Joule-Brayton cycle exhibit a few interesting characteristics:

- Heat sink temperatures above 100 °C (precooler and inter-cooler heat exchangers in Figure 76), producing calories still usable for other applications (eg, heating of buildings or salt-water desalinization);
- Maximum fluid temperature (850 °C) allowing for applications requiring high temperatures, Massive hydrogen production is one of the main applications considered at the CEA²².

In such cogeneration applications, the energy conversion systems are difficult to optimise (due to the very numerous criteria and parameters involved). The COPERNIC/CYCLOP program developed at the CEA includes modules simulating cogeneration processes and can be used to optimise the design, operation and safety of a multipurpose energy production facility based on technico-economic criteria.

For example, a COPERNIC/CYCLOP model of the coupling of a gas-cooled reactor with a high-temperature steam electrolyzer has been developed at the CEA (Fig. 81). In this case, heat is required to maintain the electrolyzer at high temperature and heat the fluids (O₂, H₂O) to the correct temperature. The coupling proposed here is achieved with a heat exchanger inserted in series with the Brayton cycle. The model developed has enabled the assessment of the hydrogen production efficiency, which increases with the core outlet helium temperature and amounts to approximately 55% for a coolant output temperature of 950 °C and a high-performance electrolyzer operating at 900 °C.

The large variety of cogeneration systems that may be associated with a GCR opens the way for extensive optimisation work. This work has only just begun. It will make it possible to confirm and specify the potential of gas-cooled reactors as energy production systems.

► Bibliography

POETTE (C.) *et al.*, "Advanced GFR preliminary design – 300 MWe project status and trends for a higher unit power selection", Conference ICAPP'04, Pittsburg, June 13-17, 2004.

TENCHINE (D.) *et al.*, "Preliminary thermal hydraulic evaluations for a gas cooled fast reactor", Conférence NUTHOS-6, Nara, October 4-8, 2004.

Patrick DUMAZ & Nicolas TAVERON,
Reactor Research Department

21. An example of the use of the CATHARE code to simulate a depressurization accident in a gas-cooled fast reactor is described *infra*, p. 122-123.

22. See *supra*, p. 103-108.

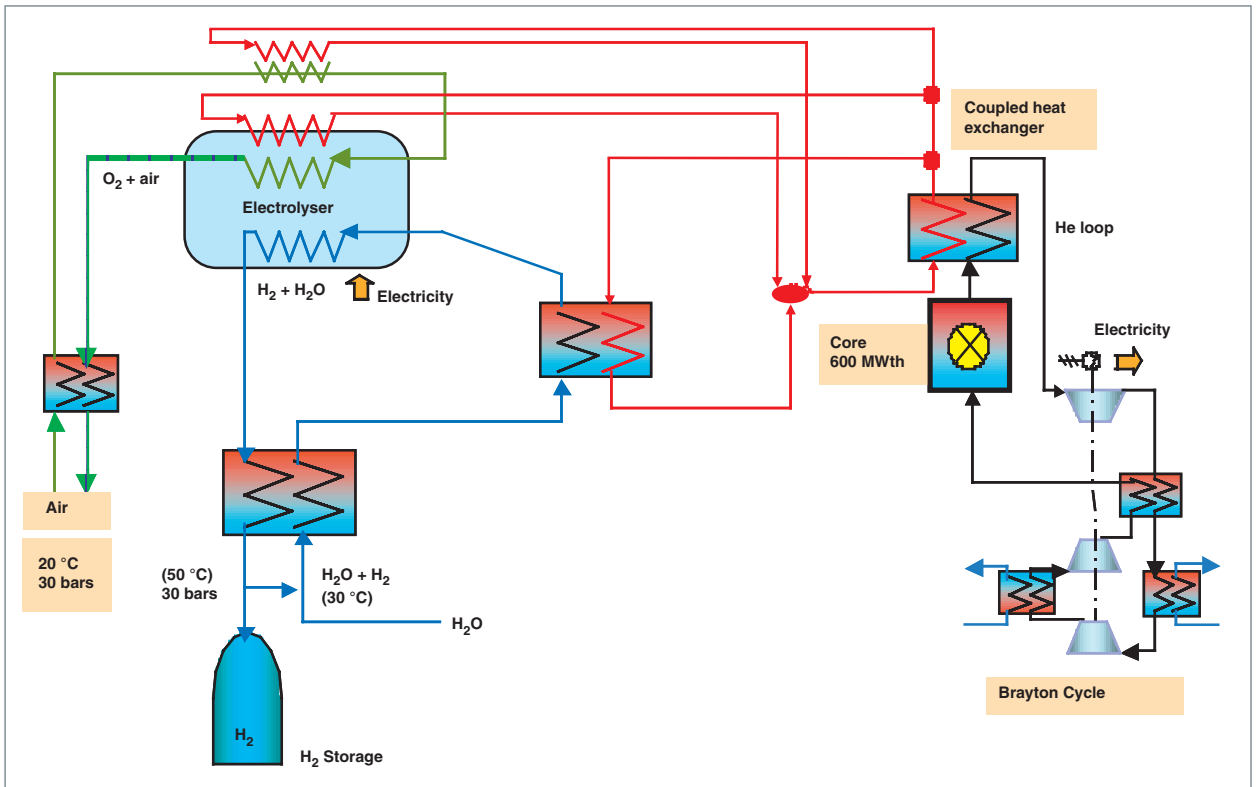

Fig. 81. Basic diagram of the coupling of a gas-cooled reactor with a high-temperature electrolyzer (modeled using the COPERNIC/CYCLOP program).

Test facilities for gas-cooled reactor technologies

Apart from an understanding of the basic physics involved, a nuclear reactor, like any industrial facility, cannot go into service unless the technology used has been tried and tested. The CEA's Nuclear Energy Division, in partnership with French industry, is developing technology test benches for testing and validating the elements and components used in high temperature pressurized helium circuits. This involves several different areas of study:

- First of all, it means ensuring a high level of expertise and understanding in the basic physics and physical processes involved: **tribology*** since, as it flows through the system, the coolant makes the parts in “dry” contact vibrate, thereby causing a risk of wear; insulation and heat exchanges, since a GCR coolant is at high temperature and the structural materials must be protected, either by active cooling, or by using thermal barriers; leaktightness, since a GCR functions at high pressure, and since the reactor inevitably integrates static and rotating seals, which carry with them the risk of leaks which result in two forms of consequences: operational (controlling pressure) and safety (need to prevent accidental breaks in the helium system); and helium purification, since the gas' power of corrosion on structural materials is dependent on impurities in the gas;
- The technology test benches should also be suitable for testing component models (heat exchangers, joints and seals, thermal barriers and blowers, etc.), in order to check their correct behavior and performance, and also to gain experience in implementing them.

Analytical and prequalification test benches

Helium tribometer

Tribology is a key subject of study in the development of gas-cooled reactors. In fact, problems involving the effects of friction and wear on various mechanisms are a major issue for a number of reasons: technical, economic (length of service life), efficiency, security (*i.e.* rod drive mechanism operability) and pollution (*i.e.* contamination of the system by particles due to wear), etc.



Fig. 82. Overhead view of the helium tribometer.

The reactor components that require the most attention from the point of view of tribology are direct cycle turbine parts, valves and fittings, safety valves, the hot duct and its thermal insulation, the control rods and their drive mechanisms.

Tribology, even though it has made considerable progress in recent years, from massive materials tribology to surface and even interface tribology, remains an extremely empirical science in which modeling and, therefore, prediction, are highly uncertain matters, due to the lack of knowledge of all the mechanisms that come into play during friction. In fact, these mechanisms call on a variety of disciplines including mechanics, physical chemistry, materials science and heat engineering, each focusing on concepts on different scales.

Tribology studies for GCRs should therefore be carried out in the most representative conditions possible, and it is with this in mind that the CEA's helium tribometer has been developed (Fig. 82).

The specific parameters relative to conditions in a GCR reactor are, firstly, the atmosphere which, depending on the level of impurities, may be very reductive, and therefore not very conducive to oxide layer turnover which may serve as solid lubricant and thus contributes to the risk of seizure and, secondly, the temperature levels in the region of 850 °C-1,100 °C.

The tribometer simulates pure sliding friction in a reciprocating movement. The tribometer used is a “pins-on-rail” alternative sliding tribometer (Fig. 83). This apparatus is divided into two parts. The mechanical part that operates the kinetics of the entire apparatus, applying the load on the “pins” and the

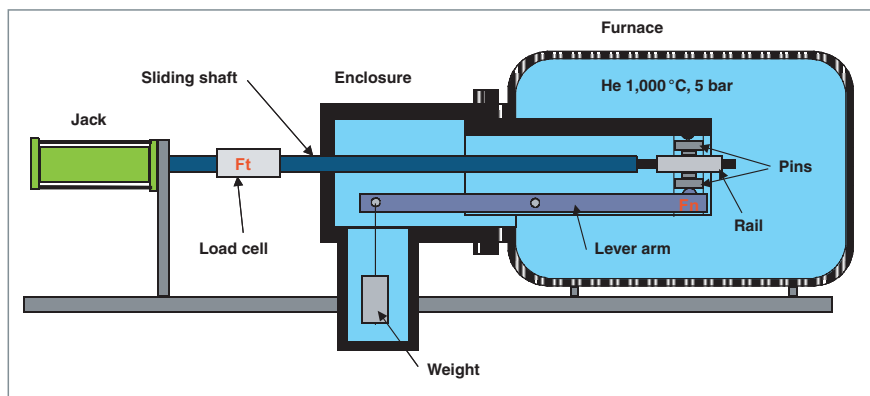

Fig. 83. Diagram of He tribometer.

motion of the “rail”; together with the furnace that controls the temperature and pressure of the operating atmosphere.

With a normal load (F_N) applied to the “pins”, a tangential load (F_T) is required to move the “rail”. The friction coefficient, μ , is calculated using F_N and F_T as shown below:

$$\mu = \frac{|F_T|}{2 \cdot F_N}$$

The tangential load (F_T) is applied by a jack by means of a cooled sliding shaft. The normal quasi-static load (F_N) is applied by a lever arm and weighting system.

The tribometer, which has been in use since 2003, can operate up to temperatures of 1,000 °C in a helium environment, with or without steam and impurities, and can impose contact pressure of 20 MPa.

The tribometer’s control and instrumentation panel, developed in-house, serves to display the different parameters, the acquisition of measurements and to manage normal operating of the tribometer and operating under incident conditions. It is used to harmonize operating of the three sub-assemblies (the furnace, tribometer and jack) which each have their own operating safety systems, and to manage safety of the whole assembly.

This tribometer is used to determine the friction coefficient, μ , to $\pm 2.5\%$.

Three categories of materials are liable to be used in tribological applications under GCR conditions:

- Up to 500 °C, metallic materials may be used, bearing in mind that the principal accommodation mechanism of surfaces in contact is “adhesion”. The main possibilities include cobalt bases, or stellites, which perform well but cause activation and contamination problems due to corrosion products in the primary system; nickel bases, such as Haynes 230, Hastelloy or Inconel 617; and iron bases, such as Norem.

- Up to 850 °C, the use of ceramic and metal composites, or CerMet, is possible. CerMet 80% Cr3C2+20% Ni-Cr, deposited using a detonation gun or using plasma or thermal spray techniques seems particularly promising.

- Above 850 °C, only ceramic can be used. Many references cite the good performance of zirconia coatings such as ZrO₂-Y₂O₃ / NiCrAlY with some other grades stabilized with high-temperature solid lubricants, such as CaF₂ or MgF₂. Other thin coatings obtained by vapor deposition may also be possible, such as TiN or SiN, together with amorphous carbon coatings, such as Lubdry®.

Initial results using the He tribometer concern tests on homogeneous material contact for Haynes 230, ZrO₂-Y₂O₃ / NiCrAlY and Lubdry® (See Table below and Fig. 84).

Showing the key significant parameters of the first tribology tests in a helium environment

Materials	Temperature (°C)	Helium quality	Contact pressure (MPa)	Friction coefficient	Number of cycles	Wear
HR 230	450	pure	5	0.4	2,600	-
	800	pure	5	0.6	1,500	-
ZrO ₂ -Y ₂ O ₃	800	pure	2	0.55	5,000	+
	1,000	pure	2	0.6	1,000	--
LUBODRY®	800	pure	2	0.7	1,000	---
	500	pure	5	0.5	1,000	---
	800	pure	0.5	0.5	1,000	---

---: disappearance of coating, --: substantial wear, -: significant wear, 0: average wear, +: good resistance.

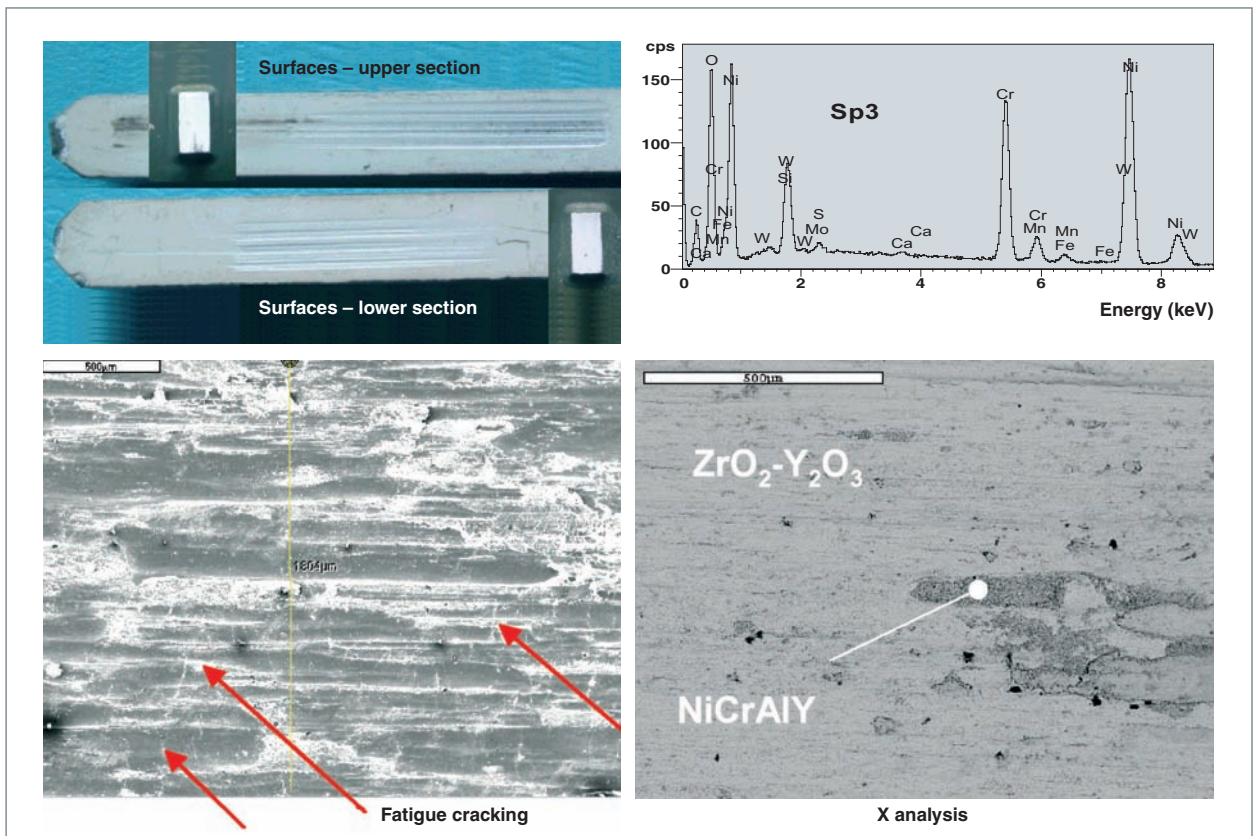

Fig. 84. Example of test performed on sample surfaces following testing on the tribometer.

Top left: macroscopic view of a Haynes 230 alloy sample, coated with yttria-zirconia $ZrO_2-Y_2O_3$ with a previously deposited sublayer of Nicralloy (NiCrAl), the accommodation material between the ceramic coating and the metal backing material. The sample was subjected to 5 000 cycles under a load of 2 MPa at 800 °C on the helium tribometer;

Bottom left: SEM image of the area of wear, in which fatigue cracking can be distinguished from local galling of the coating material; Right (top and bottom): X-ray elemental analysis of the area of wear reveals exposure of the previously deposited sublayer of Nicralloy.

Thermal barrier tests (HETHIMO test bench)

Given the high temperature expected for GCR gas coolants, special precautions should be taken to ensure that core structures are resistant at such high temperatures. Two generic principles are considered, either separately or together, for protecting these structures: thermal insulation and active cooling.

The HETHIMO (Helium THERmal Insulation Mock-up) test bench was developed at the Laboratory for the study of gas-cooled reactor technology in Cadarache (France), setting up a thermal barrier with a view to insulating GCR structures in-house. It consists of a 30 kW heater and a test section part, simulating straight pipework (see Fig. 85). HETHIMO is used to qualify thermal barriers insofar as regards their thermal performance in a helium environment under maximum conditions of 1,000 °C and 100 bars, together with their mechanical resistance. To this end, the experimental program is divided into three parts. To begin with, static tests are performed to quantify thermal barrier insulation performance and also to

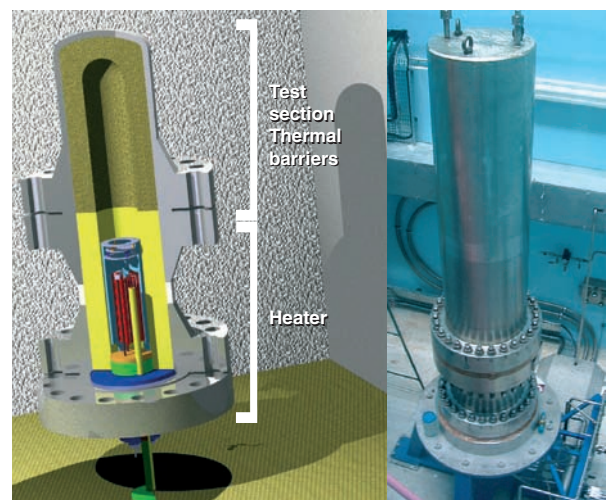

Fig. 85. The HETHIMO bench for testing thermal barriers.

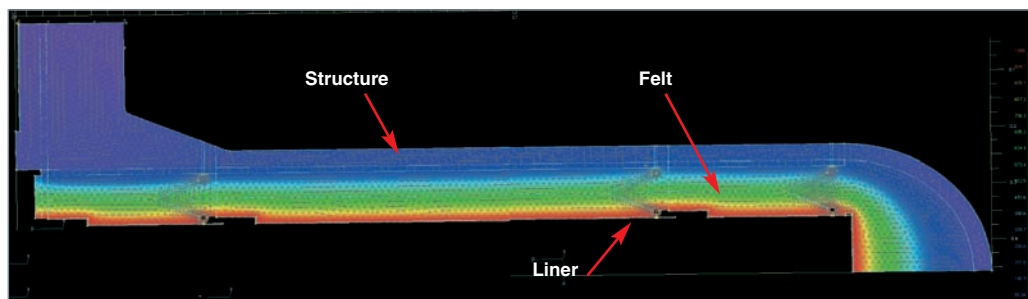

Fig. 86. Calculating thermal behavior of a barrier.

verify its dimensional stability and resistance at high temperature. Dynamic tests serve to assess the thermal barrier's mechanical resistance, on the one hand under transient or cyclic thermal stress and, on the other hand, under mechanical stress due to total or partial depressurization of the cooling system, with depressurization kinetics of up to 20 bars/s.

The first thermal barriers to be tested include a composite structure implementing one or more nickel-based metal liners, together with a calcium silicate ceramic felt (Fig. 86).

The first qualification tests will be performed on straight sections. Eventually, studies will also be made of insulation of the elbow and connection zones. Only the upper section of the HETHIMO test bench, named the "Test Section" will need to be adapted to suit each case studied.

Leaktightness tests (the HETIQ test bench)

Two major issues are involved in GCR leaktightness – the first being financial, since helium, a fossil resource, is not cheap, and the second concerning safety, even if helium contamination levels are deemed to be low.

Areas of static leaktightness, such as flanges, or dynamic leaktightness, such as rotating shafts, should, by design and as far as possible, be limited even though they are inevitable, at least in the case of static leaktightness.

The HETIQ (HElium TIghtness Qualification) test bench has recently been developed in order to study this in depth (Fig. 87). It consists of a heater or around 30 kW and a scalable test section.

HETIQ can be used to study all types of static or dynamic leaktightness systems likely to be found in a GCR, in representative conditions: leaktight seals between two flanges, sealed connectors and components, etc. To begin with, the test bench is being developed to qualify static seals. Two kinds of test will be performed on this test bench. Creep tests, which involve maintaining steady state operating for a pre-set and significant period of time to quantify leakage levels over time: fatigue tests based on thermal cycling of the elements forming the connec-

tion, either in phase, to simulate fluid temperature variations, outage or startup of the facility, or out of phase, to simulate connections made up of parts with different thermal inertia, such as the flange connection between a valve and a pipe.

The seals that are likely to be tested are metallic and dimensioned for operation at temperatures up to 500 °C under a pressure variation of 100 bars of helium. The expected leak criterion under such conditions is 10^{-5} mbar.l.s⁻¹.

The parameters measured during tests will be the leak rate and the stress of each bolt used to tighten the seal.

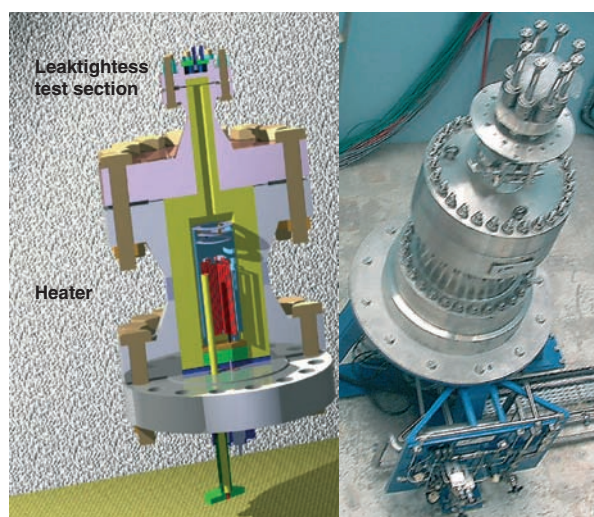

Fig. 87. The HETIQ test bench for testing and qualifying helium leaktightness seals.

The HELITE technology loop

To master the technologies related to gas-cooled reactors, we need an experimental facility that tests the use of helium (or the secondary system gas) under the temperature, pressure and speed conditions representative of a GCR. To this end, the construction of a gas technology loop called HELITE (Helium Loop for Innovative Technology) is planned at Cadarache (Fig. 88).

The main objectives of this facility are, using high and medium temperature test sections, to test and validate various technological components or assemblies that may be used in GCRs, to qualify the thermal dimensioning and heat exchanger technologies, to validate the principle of helium purification and quality control (HPC-CC module, for chemistry control) and, lastly, to deepen our knowledge of the behavior of these systems. HELITE will use various configurations depending on the kind of technological component or assembly that needs qualifying.

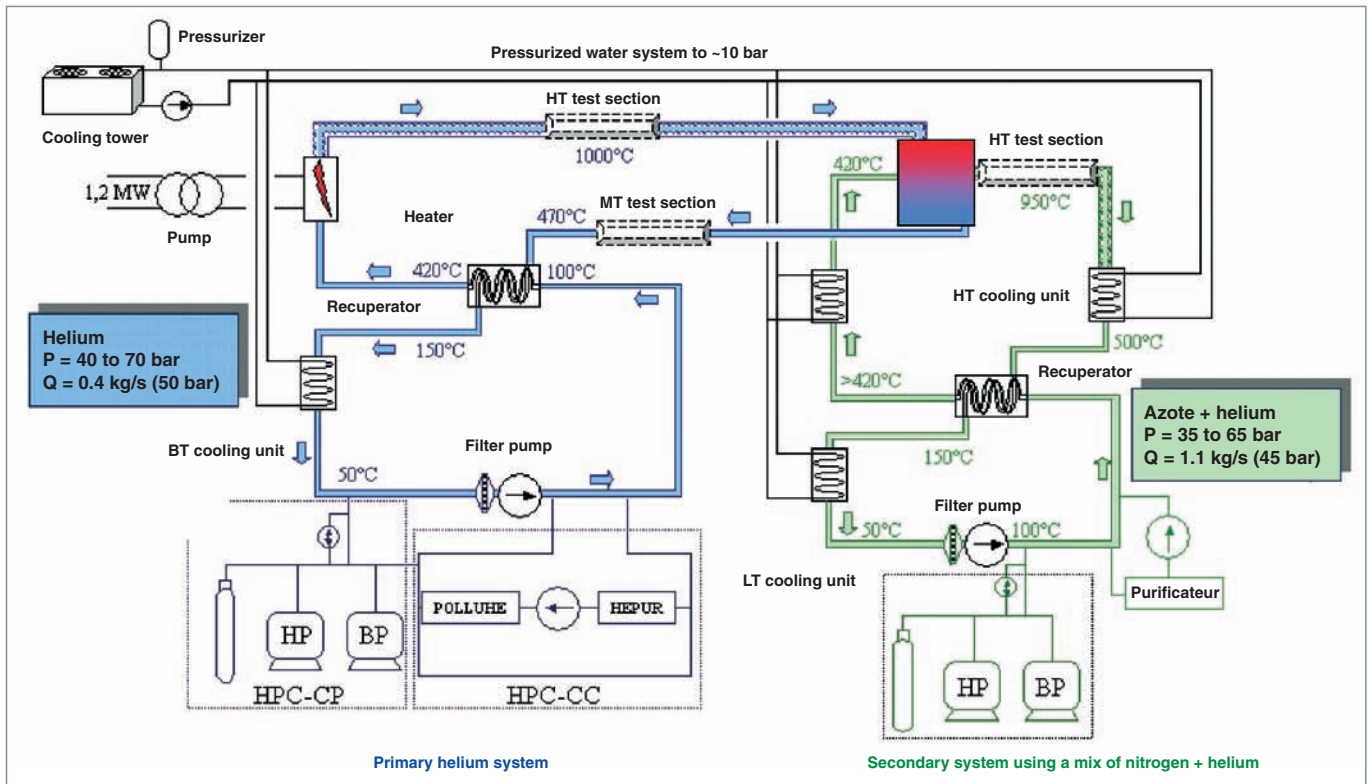

Fig. 88. Diagram showing the operating principle for HELITE, the technology test loop.

Description of the primary system: (helium system, shown in blue, in the direction of fluid flow)

The pump regulates the rate of flow in the system (0.4 kg/s at 50 bars). As it leaves the pump, the helium is at a temperature of around 100 °C. It enters the recuperator (heat exchanger – economizer) where it is heated to 400 °C and then is heated, by the heater, up to its maximum temperature (1,000 °C max). This is the end of the helium heating stage.

The gas then passes into a high temperature test section (HT) (Length = 5 m, Hydraulic diameter = 100 mm) and then enters the IHX (Intermediate Heat eXchanger, the component that separates the primary from the secondary system). As it leaves the IHX, the gas passes through a medium-temperature test section (MT), and then circulates back through the

recuperator again and then into the low-temperature cooling unit (LT) lowering to 50 °C and thus to a temperature that is compatible with the operating of the pump.

The Pressure and Chemical quality of the helium are controlled by the HPC-CP and HPC-CC modules respectively.

Any traces of impurities in the helium are measured by chromatographic analysis in the gas phase and by mass spectrometry. One of the difficulties with this measurement technique lies in the fact that it is carried out under cold conditions, and thus may not be representative of impurity content under hot conditions.

**Description of the secondary system:
(nitrogen/helium system, shown in green,
in the direction of fluid flow)**

The gas comes out of the pump at a temperature of approximately 100 °C, enters a recuperator, and then enters an auxiliary cooling unit to control the IHX inlet temperature. Following this, the gas enters an HT test section, and is then cooled by the HT cooling unit, the recuperator and then the LT cooling unit.

Two special modules control the pressure and chemical quality of the gas.

This loop configuration will make it possible to qualify a heat exchanger module at high temperature (1/100), up to 1,000 °C with heat exchange power of 1.1 MW, under nominal operating and also under transient operating conditions (transient incident emergency shutdown and blower trip), to qualify hot pipework concepts for temperatures up to 1,000 °C with

helium and up to 950 °C with a nitrogen/helium mix, to qualify combined helium and water cooling units (for the GCR backup system) and to study other generic technologies linked to GCR development.

Future developments concerning the loop are expected in a bid to qualify exchange components for direct-cycle GCRs under normal or accident operating conditions, to characterize the assembly hydraulics in order to develop the Technology Test and Development Reactor (REDT) using full-scale models, validate the principles involved in residual heat removal and validate the idea of coupling HELITE with a hydrogen production plant.

The HELITE test facility is being built at the Cadarache site and is expected to be in service as of 2006.

Philippe BILLOT,

Nuclear Development and Innovation Directorate

Nuclear production of hydrogen?

There is a wide international consensus that hydrogen offers considerable promise as a potential solution [1] to the ever increasing demand for energy that would both reduce the production of greenhouse gasses and slow down the depletion of fossil fuel resources. This solution would require the production of vast quantities of hydrogen. In addition to its traditional uses in the chemical and petrochemical industries, hydrogen is already employed as a propellant fuel in space vehicles. It has also been used experimentally as a fuel for transportation systems, both in addition to and as a replacement for hydrocarbon fuels. Hydrogen is also used to power fuel cells and in the production of electricity and heat. One important characteristic of this gas is that it can be stored, transported and used without any emissions of greenhouse gasses. Maintaining this advantage during production requires the use of a process based on the dissociation of the water molecule [1]:

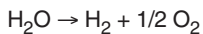

There are two methods: High temperature electrolysis (HTE) and **thermochemical cycling*** (TC). These processes require a considerable input of primary energy (electricity and heat) in order to produce large quantities of hydrogen. Nuclear energy is capable of providing this requirement without emitting carbon dioxide. The CEA is studying the medium term potential for the large-scale production of hydrogen using these methods in conjunction with the very high temperature heat available from the HTR reactor.

High temperature electrolysis

Regardless of the method used, a quantity of energy equal to the enthalpy $\Delta H(T)$ at the reaction temperature T is needed in order to dissociate one mole of water in an open system under constant pressure [1]. In an ideal electrolyzer operating in the reversible region, i.e. with an infinitesimally small current, the energy required to dissociate one mole of water is electrical energy equal to the free enthalpy $\Delta G(T)$ plus heat energy

equal to $T\Delta S(T)$ in accordance with the thermodynamic relationship $\Delta H(T) = \Delta G(T) + T\Delta S(T)$, where $\Delta S(T)$ is the dissociation entropy of water.

Under these conditions, the potential difference across the electrodes required to produce one mole of hydrogen is given by $(V_{\text{anode}} - V_{\text{cathode}}) = \Delta G(T) / 2F$, where F is the charge on one mole of electrons (96 500 coulombs). The numerical values of these parameters at a pressure of one atmosphere and a range of characteristic temperatures are given in the table below [2] :

This table shows that the energy required to dissociate one mole of water reversibly is less when the water is in the vapor state ($T = 400, 600, 1,000 \text{ K}$) than when it is liquid ($T = 298 \text{ K}$). As the temperature at which dissociation is carried out increases, the proportion of electrical energy provided may be reduced, providing that the heat energy input is increased. The high temperature electrolysis of water vapor can therefore take advantage of the heat supplied by a VHTR reactor.

The table also shows that water can be electrolyzed at very low voltages of between 1.0 and 1.2 volts. Higher voltages are required in practice, as a number of irreversible processes are involved. These include the dissipation of heat due to the Joule effect in both the ionic conduction through the electrolyte and the electronic conduction through the electrodes. The voltage also has to be increased in order to displace reactions occurring at the electrodes and maximize the release of the gasses.

A further increase in voltage is required if it is necessary to overcome a potential barrier in order to permit the exchange of electrons between the electrodes and the electrolyte. This is an activation mechanism. For a given electrode-electrolyte pair, this potential barrier is reduced as the temperature rises. This is another advantage of operation at high temperature. At a constant voltage, this additional electrical energy provides

Thermodynamic parameters associated with the dissociation of water at a range of temperatures

T(K)	$\Delta H(T)$ (kJ/mole)	$\Delta G(T)$ (kJ/mole)	$T\Delta S(T)$ (kJ/mole)	$(V_{\text{anode}} - V_{\text{cathode}})$ (V)
298	285.8	237.1	48.7	1.23
400	242.8	223.9	18.9	1.16
600	244.8	214.0	30.8	1.11
1,000	247.9	192.6	55.3	1.00

sufficient heat input via the Joule effect at low temperatures. This is no longer the case at high temperatures, however, and additional heat must be provided over and above that generated by the Joule effect. An electrolyzer may therefore operate in a number of modes [3]. These include the autothermal mode in which energy is supplied in the form of electrical energy only, and the allothermal mode in which the electrical energy supplied is reduced to the absolute minimum and the high temperature heat needed is supplied by a VHTR. As water vapor is not a conductor of electricity, the electrolysis of water vapor requires the use of solid electrolytes that are both porous and ionic conductors. Yttrium-doped zirconia is well suited to HTE applications as it is capable of withstanding high temperatures and has a good ionic conductivity at temperatures above 1,000 K. The dissociation of the water vapor occurs at the cathode: $\text{H}_2\text{O} + 2\text{e}^- \Rightarrow \text{H}_2 + \text{O}^{2-}$. The O^{2-} ion migrates towards the anode forming oxygen: $\text{O}^{2-} \Rightarrow 1/2 \text{O}_2 + 2\text{e}^-$. This Solid Oxide Electrolysis Cell (SOEC) therefore operates in the inverse manner to a Solid Oxide Fuel Cell (SOFC) as shown in Figures 89 et 90. The development of this electrolysis technology therefore benefits from all the R&D that has been carried out in the fuel cell field.

Two designs of electrolyzer have been developed; tubular and plane. Laboratory prototypes have been tested in the USA, Germany and Japan between 1975 and 1990.

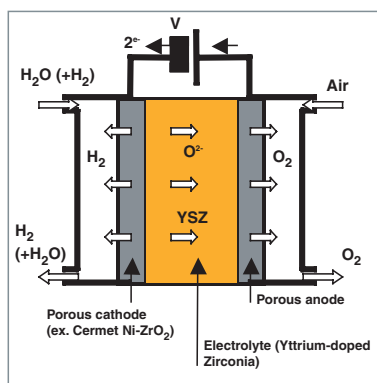

Fig. 89. SOEC electrolyzer.

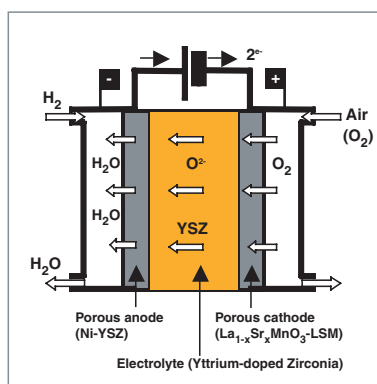

Fig. 90. SOFC hydrogen fuel cell.

The CEA has been carrying out a program of research since 2002 covering all aspects of HTE but concentrating on modeling, operation in conjunction with to a nuclear reactor and technical and economic developments. This work culminated in a partnership between the CEA and other European partners with the aim of developing a plant capable of producing 200 liters of hydrogen per hour from water pre-heated to 200 °C by a geothermal heat source and an autothermal electrolyzer operating at a target temperature of 700 °C (Fig. 91).

What sort of efficiencies can be expected from a large-scale HTE hydrogen production plant? The thermal efficiency depends mainly on the temperature at which the electrolyzer operates and the efficiency of the electrical energy generation plant h . In the case of a PWR, $\eta = 0.33$, while for a VHTR, $\eta = 0.48$. It is evident at the present time that the efficiency of an industrial water electrolysis process will certainly be increased by the use of high temperature electrolysis in conjunction with a VHTR.

Thermochemical cycles

An alternative method of producing hydrogen is by the thermolysis of water at temperatures higher than 2,600 °C.

However, economic and technical difficulties make it unlikely that this process will be used on a large scale. Thermochemical cycling may be used to dissociate water at lower temperatures. A thermochemical cycle is a series of several thermally-assisted chemical reactions whose overall effect is to dissociate the water. The initial reagents added to the water are reconstituted as the reactions proceed and are therefore continuously recycled.

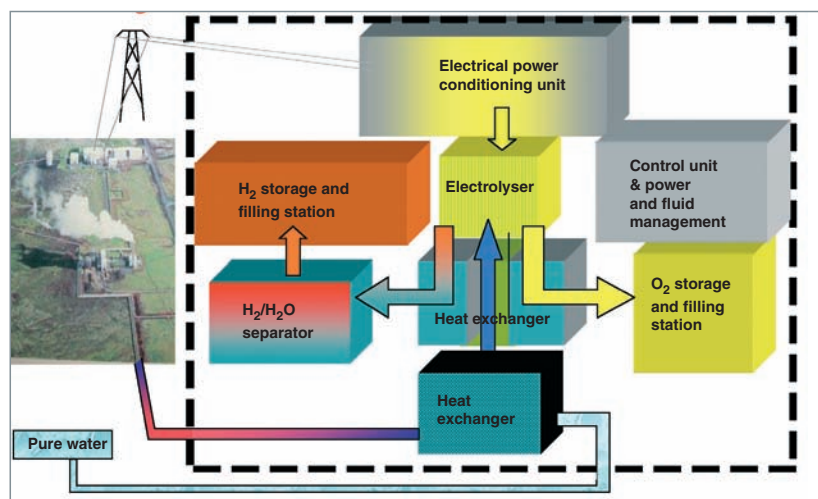

Fig. 91. The GEYSER plant at Nesjavellir in Iceland produces hydrogen by electrolysis, using geothermal energy to provide both the electricity and heat needed for the process.

Cycles requiring an electrolysis stage are said to be hybrid cycles. The concept of hydrogen production by means of the thermochemical dissociation of water was first studied from a thermodynamic point of view by FUNK and REINSTROM in 1964 [4]. The earliest known research into thermochemical cycles was carried out by the Ispra joint European research center in Italy between 1960 and 1983. During this period, twenty four cycles capable of operation in conjunction with an HTR were investigated. The hybrid bromine-sulfur cycle was developed to the laboratory demonstrator stage and has run for a year and a half to date, making it the longest running thermochemical cycling experiment at the present time. At the same time, the Gas Research Institute in the USA has been carrying out a major research program during the course of which over two hundred thermochemical cycles have been examined. One of the group of eight most promising cycles, the iodine-sulfur cycle, has been studied by General Atomics. The Russians have also carried out research into thermochemical cycles. They have built a small-scale demonstration loop using the hybrid sulfur cycle.

The CEA carried out chemical engineering, technical and economic studies on the same cycle on behalf of Euratom in the 1970s. Finally, the Japanese have concentrated their efforts on the UT-3 cycle (see below) and the iodine-sulfur cycle. Laboratory scale demonstration loops have been successfully demonstrated for both processes. The thermochemical cycling research programs that were started in the immediate aftermath of the first oil crisis were all abandoned when oil prices fell during the 1980s. Only Japan maintained a program in this field up until the present day.

Research was restarted in 2000, and this has led to a new series of studies to evaluate thermochemical cycling. One of the most recent [5] identified four cycles of interest on the basis of technical and economic criteria. These were the hybrid sulfur or Westinghouse cycle, the Ispra hybrid bromine-sulfur cycle, the UT-3 cycle and the iodine-sulfur cycle.

The UT-3 cycle

This cycle was developed by the University of Tokyo in the 1980s. A laboratory pilot plant has operated for several days. The cycle consists of four reactions between a gas and a solid:

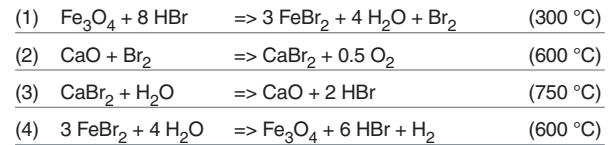

Reactions (1) and (3) produce the reagents for reactions (2) and (4). The process therefore consists of a loop of four fixed-bed reaction vessels in a single loop through which the reaction gasses are fed. The main disadvantage of this cycle is that it is discontinuous. The flow around the loop must be reversed when all the reactions in the four reaction vessels are complete. This reversal process is incompatible with the use of an HTR as the demands for heat and temperature are different in each of the reaction vessels. The cost of manufacturing the reagents and the toxicity of the bromine outweigh the simplicity of the process, making this cycle unattractive.

The sulfur cycles

These sulfur-based cycles include the hybrid sulfur cycle, the hybrid bromine-sulfur cycle and the mainly chemical iodine-sulfur cycle. These cycles all involve the decomposition of sulfuric acid to form sulfur dioxide which is then recycled:



The vaporization of the sulfuric acid and its decomposition are both endothermic reactions. They take place at high temperature in a corrosive environment. The thermal coupling to an HTR in order to achieve the decomposition has been modeled.

Fig. 92. The heat and temperature required for the various stages in the decomposition of H_2SO_4 are shown by the histogram with the solid line. The heat supplied by a VHTR at the optimum coolant flow rate and temperature is shown by the broken line. In order for the decomposition reaction to proceed, the temperature of the heat source (coolant) must be greater at all times than that required for the H_2SO_4 decomposition process. The proximity of the two histograms shows the excellent match between the heat supplied by the coolant from a VHTR and the heat required for the various stages in the process.

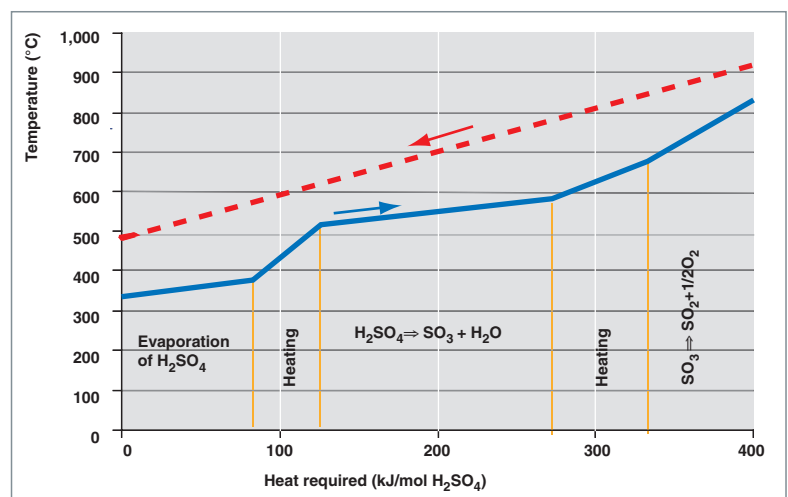

As is shown in the heat-temperature requirement diagram in (Fig. 92), the heat from the HTR may be used successfully, giving a thermal efficiency for the decomposition of up to 70 %.

Hybrid sulfur cycle (known as the Westinghouse cycle in the USA)

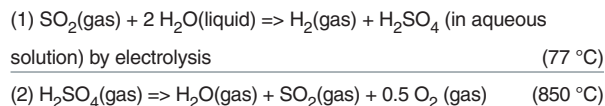

This hybrid cycle includes a low-temperature electrolysis stage to produce the hydrogen. The sulfur dioxide consumed is then reconstituted by the high temperature decomposition of sulfuric acid. This cycle is very simple in principle. The main avenue for further development is to reduce the voltage. This is currently 0.6 V while, in theory, 0.17 V should be sufficient. This cycle appears to be promising, in spite of the requirement for electrical energy with the associated economic disadvantages. The efficiency of the process has been calculated at between 37 and 41 % [6].

Ispra sulfur-bromine cycle

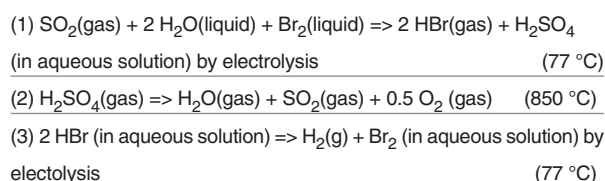

In this hybrid cycle, the electrolysis stage does not involve a reaction producing sulfuric acid as is the case in the hybrid sulfur cycle. In this case, electrolysis is used to dissociate an aqueous solution of hydrogen bromide to produce hydrogen. The theoretical voltage for this dissociation is 1.066 V at ambient temperature. As the thermodynamic efficiency of a plant is given by the ratio of the energy recoverable via the recombination of H_2 and O_2 to the total energy inputs (heat and electrical energy), this high voltage implies a relatively poor efficiency. The voltage may, however, be reduced by carrying out the electrolysis at a higher temperature (see High temperature electrolysis). The other disadvantage of this cycle is the toxicity of the bromine.

Iodine-sulfur cycle

The iodine-sulfur cycle [7] is currently considered by all the teams who have worked on it to be the thermochemical cycle with the greatest potential advantages for the production of hydrogen. This cycle is totally chemical in nature. The CEA has been studying this cycle since 2003 with the aim of assessing its efficiency and profitability. These studies have been carried out in collaboration with American teams from General Atomics, Sandia National Laboratory and the University of Kentucky. Collaboration agreements have also been signed with Japanese teams from the JAEA and with European col-

laborators as part of the HYTHEC research project. This cycle consists of the following three reactions:

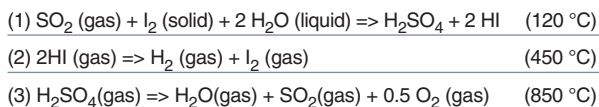

Reaction (1) or the stoichiometric Bunsen reaction, is not spontaneous even at a temperature of 120 °C at which all the reagents are fluids (melting point of iodine = 114 °C). In order to make this reaction thermodynamically favorable and shift the equilibrium towards the right, water must be added to reduce the free enthalpy of the reaction by diluting the acids H_2SO_4 and HI. General Atomics also showed in the 1980s that adding iodine caused an aqueous solution of sulfuric acid to separate out above a layer containing an aqueous solution of polyhydriodic acid as shown in Figure 93.

The Bunsen reaction as optimised by General Atomics (Fig. 94) is very exothermic. One solution adopted in order to reduce this loss of energy (which adversely affects the effi-

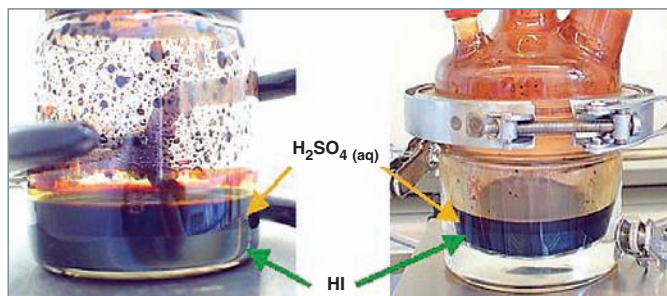

Fig. 93. Products of the Bunsen reaction: The lighter sulfuric acid phase is above the heavier polyhydriodic acid phase. A block diagram of the process is given in Fig. 94.

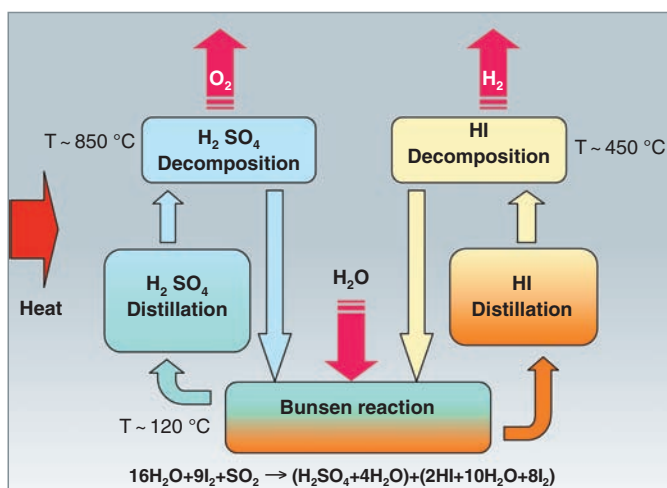
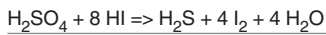
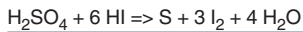

Fig. 94. Block diagram of the iodine-sulfur cycle.

ciency) is to reduce the quantities of water and iodine involved in the reaction. A disadvantage of this solution is that it promotes the formation of by-products including sulfur and H_2S by means of the following reactions:



Following the separation of the two immiscible acids, the HI must be extracted from the polyhydriodic acid solution ($2HI+8I_2+10H_2O$) for use in the decomposition reaction (2). These two stages are currently still poorly controlled due to both the presence of an **azeotrope*** in the HI- I_2 - H_2O ternary mixture which complicates the separation of the hydriodic acid and the water, and to the difficulty in decomposing HI into I_2 and H_2 in the vapor phase. This latter process is very slow and partial. A number of solutions have been proposed in order to overcome these difficulties:

- The solution recommended by General Atomics involves the use of phosphoric acid to separate out the iodine and to partially dehydrate the aqueous solution of hydriodic acid. This partial dehydration also breaks down the azeotrope, making it possible to separate the hydriodic acid from the water. This acid is then liquefied under pressure and catalytically decomposed to obtain hydrogen and iodine in the liquid phase which is then recycled;
- The solution proposed by the JAEA includes an electro dialysis stage prior to the traditional distillation stage. This concentrates the hydriodic acid in the aqueous polyhydriodic acid phase with the aim of overcoming the azeotrope. Hydrogen is then produced using a reactive membrane to dissociate the HI and separate the I_2 and H_2 ;
- The solution proposed by RWTH (Aachen, Germany) involves the production of hydrogen in a single step by means of a reactive distillation of the aqueous solution of polyhydriodic acid. This distillation process includes the establishment of a liquid-vapor equilibrium dissolving the iodine as it is produced by the decomposition of HI. This solution is currently thought to be promising by the CEA and GA.

This cycle, consisting of the Bunsen reaction as optimised by GA, reactive distillation and decomposition of H_2SO_4 as described above, is estimated to have an efficiency of 35 %.

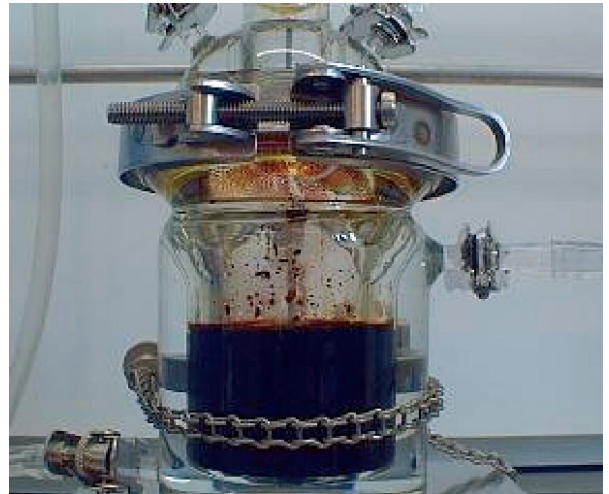

Fig. 95. The B0 reaction vessel built by the Physics and Chemistry Department is used to demonstrate the separation of the phases produced by the Bunsen reaction, and to quantify the composition of the phases in equilibrium (see example in Fig. 96).

In order to improve this efficiency, the CEA is carrying out research into the stoichiometry of the initial reagents in the Bunsen reaction with the aim of identifying the best compromise between the thermodynamics, the phase separation and the energy losses, and reducing the energy needed to concentrate the HI by evaporation of the water and separation of the iodine (Fig. 95).

Due to the corrosive nature of the environment, intensive work is continuing to acquire experimental data using non-intrusive techniques to determine the compositions of the liquids and gasses (visible UV, spectrophotometry, ICP-AES, IRTF spectroscopy, spontaneous Raman diffusion, etc.).

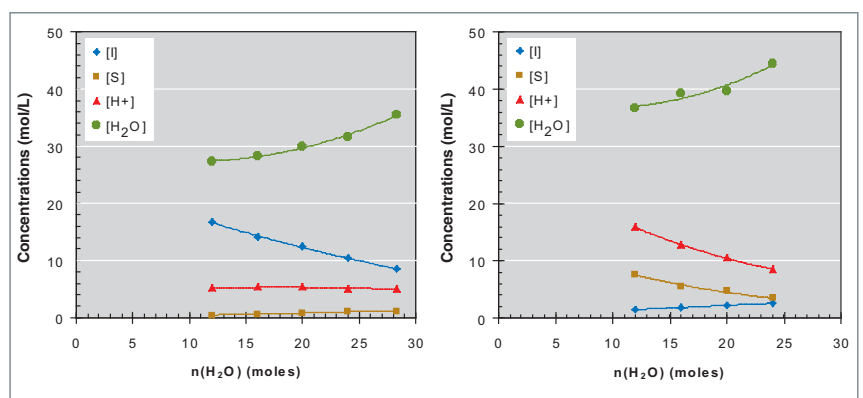

Fig. 96. Total quantities of iodine, sulfur, protons and water measured in the HIx phase (left) and in the sulfuric acid phase (right) obtained by mixing $HI/H_2SO_4/I_2/H_2O = 2/1/2/n$ (molar proportions) at 303 °K.

Initial results indicate that there may be a margin available to reduce the quantity of iodine. The available margin for reducing the quantity of water is less certain due to the appearance of side reactions resulting in reduced and undesirable sulfur compounds.

Studies into the use of reactive membranes to improve the dissociation of HI are also currently in progress. These are important developments for the iodine-sulfur cycle. The CEA expects this research program to result in improved efficiencies of up to 50 %.

► References

- [1] "Pourquoi l'hydrogène ?"; Association française de l'hydrogène, www.afh2.org.
- [2] J.-M. BORGARD et S. GOLDSTEIN, Training materials "Hydrogène et pile à combustible", INSTN, 2004.
- [3] G. RODRIGUEZ et T. PINTEAUX, "Studies and design of several scenarios for large production of hydrogen by coupling a high-temperature reactor with steam electrolyzers", proceedings of the first EHEC, 2003, Grenoble.
- [4] J.E. FUNK and R. REINSTROM, "Energy requirements in the production of hydrogen from water", *Industrial and Engineering Chemistry Process Design and Development*, **5**, 1966, p. 336-342.
- [5] J.E. FUNK, "Thermochemical hydrogen production : past and present", *International Journal of Hydrogen Energy*, **26**, 2001, p. 185-190.
- [6] G. BEGHI, "A decade of research on thermochemical hydrogen at the Joint Research Centre, Ispra", *International Journal of Hydrogen Energy*, **11**, 1986, p. 761-771.
- [7] M. SAKURAI et al., "Preliminary process analysis for the closed cycle operation of the iodine-sulfur thermochemical hydrogen production process", *International Journal of Hydrogen Energy*, **24**, 1999, p. 603.

► Bibliography

GOLDSTEIN (S.), VITART (X.) et BORGARD (J.-M.), "General comments about the efficiency of iodine-sulfur cycle coupled to a high temperature gas-cooled reactor", *Nuclear Production of hydrogen*, OECD, Argonne, USA, October 2-3, 2003, p. 85-98.

VITART (X.), BORGARD (J.-M.), GOLDSTEIN (S.) et COLETTE (S.), "Investigation of the I-S cycle for massive hydrogen production", *Nuclear Production of hydrogen*, OECD, Argonne, USA, October 2-3, 2003, p. 99-109.

Jean-Louis FLÈCHE

Physics and Chemistry Department

The GFR system: Fuel cycle closure

From the U 235 economy to the U 238 and thorium economy, through recycling

U 238 and Th 232, the heavy isotopes most abundant in nature, are not able to maintain a fission chain reaction. It is nevertheless possible to benefit from the energy potential of these fertile nuclei, since they are respectively converted to Pu 239 and U 233 (fissile at all incident neutron energies) through neutron capture. This process preserves (**isogeneration***) or increases (**breeding***) the fissile nuclei inventory during burn-up, until the depletion of heavy nuclei. Neutron absorption by a fissile nucleus (through fission or capture) causes its disappearance. It is therefore necessary for this absorption to produce more than two neutrons on average (one to sustain the chain reaction, another for isogeneration). The performance of each fissile nucleus is indicated by parameter η (number of neutrons produced per neutron absorbed, as a function of neutron energy).

Figure 97 shows that Pu 239 is the isotope with the highest performance according to this indicator, under “hard” fast spectrum conditions. U 233 shows a lower performance under fast spectrum conditions, but remains more constant in terms of energy. This reduces the spectrum hardening requirements and broadens the range of candidate reactor systems.

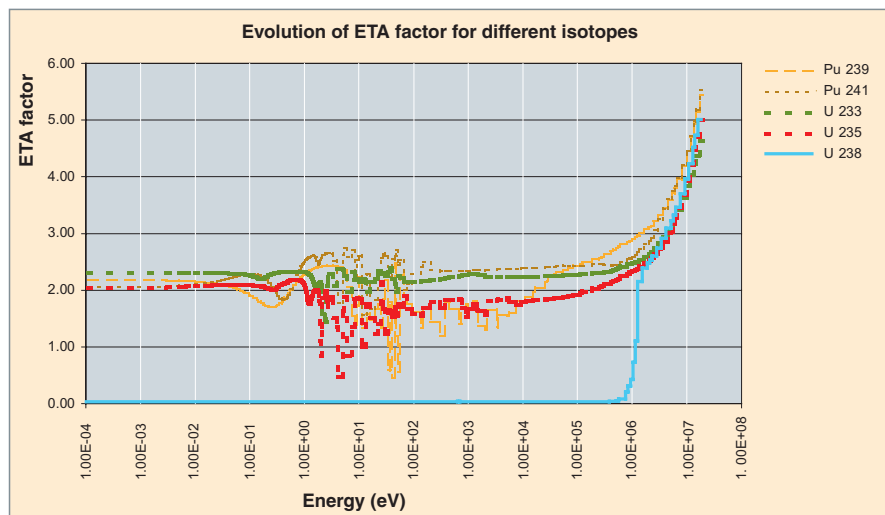

Fig. 97. Number of neutrons produced per neutron absorbed, as a function of neutron energy.

In both cases, whether using uranium or thorium, the imperative condition is the **recycling*** of fissile materials. In the case of uranium, the final resource is U 238, more than half of its mass can lead to fission. One gram of natural uranium therefore equals one **TOE***. The use of a fast spectrum for U-Pu recycling also prevents the degradation of the isotopic composition of the plutonium after multiple recycling steps.

The plutonium acts as a catalyst completely engaged in the recycling loop, which avoids having to constitute an inventory of unused materials. The total inventory in the reactor and cycle is very low as compared to the practically unlimited resources that can be exploited from it.

The asymptotic solution for sustainable nuclear energy is therefore isogeneration/breeding recycling and for the uranium/plutonium combination recycling under fast spectrum conditions. It is therefore necessary to implement an industrially optimised plutonium recycling program and make use of U 235 so as to ensure a competitive end of life for conventional water-cooled, plutonium-burning Generation III reactors (and possibly HTRs) and launch a fleet of isogenerator or breeder reactor systems to make the transition towards an optimised and responsible U 238 economy incorporating waste management.

Constraints associated with the implementation of an industrially optimised plutonium-recycling program

Certain constraints are of neutronic origin. The small interaction cross sections of fast neutrons (100 times less than thermal neutron cross sections) must be compensated by a high density of fissile matter and by a high neutron flux. Furthermore, the fast spectrum requires a minimal neutron slowdown and sterile capture, thus leading to tight core geometries. It is also necessary to reduce neutron leakage, a constraint which, for a given power density, favors high-power cores.

Moreover, various factors, including neutronics, favor a transition from oxide fuels to more advanced and denser carbide-type fuels. There are also technological and techno-economic constraints. High burn-up fractions are necessary to valorize the fuel production and processing costs. The plutonium and/or U-235 inventory required to generate one electric gigawatt must be minimised, at least during the development of the fast-neutron reactor fleet. Such a minimisation entails a high reactor specific power and a short out-of-reactor cycle time. These parameters also favor short fissile material **doubling times*** and minimum plutonium degradation through Pu 241 decay into Am 241 (half-life 14.3 years).

On the other hand, the high specific power, combined with the high in-core concentration of heavy nuclei required for a hard spectrum, results in a high power density which impacts the design of engineered safety systems. Moreover, a short out-of-reactor cycle imposes significant constraints on the design of the fuel recycle plants.

The fast flux exceeding 1 MeV causes irradiation damage to core materials and flux-exposed structures. The very high level of fast fluence for a given quantity of energy produced poses a significant constraint for the GFR system design.

Regarding the recycling strategy, several criteria must be considered and weighed against each other. In terms of neutronics, fuel fabrication and out-of-reactor cycle time, it is preferable to recycle the Pu with a minimum load of Am and Cm. Moreover, it seems advantageous to avoid neutron flux re-exposure of materials that contribute to the formation of upper minor actinides, even in limited quantities.

However, the decrease in **potential radiotoxicity*** of the waste favors in-reactor Am **transmutation***. This also allows for considering the production of light glasses and the reduction of the storage footprint for long-lived radioactive waste. Proliferation resistance issues may lead to privileging certain options involving the grouping of transuranian elements.

As a result, two options remain: use of a “light” fuel associating uranium and plutonium (and possibly neptunium), or complete recycling of the actinides. The second option is currently privileged, as it leads to a reduction in the quantity of final waste.

Advantages and issues regarding the GFR, considered as the modern “boiler” for fuel cycle closure

The asymptotic solution described above can first be implemented in reactors already benefiting from operating experience, *i.e.*, sodium-cooled fast neutron reactors using MOX fuel rods (potentially of carbide type).

The Generation IV GFR project addresses a twofold challenge: combining high thermodynamic efficiency through high temperatures, and high neutronic efficiency (with significant economization of resources in the case of the uranium-plutonium cycle) through fast spectrum conditions. It has therefore been referred to as a “high-efficiency reactor”, constituting the second wave of modern GCRs (beyond HTRs). In that sense, it differs from other concepts such as the EGCR (British 1,400 MWe gas-cooled fast reactor project adopting more conventional solutions for the coolant, fuel, reactor vessel and backup systems, and sacrificing high temperatures in favor of fast spectrum conditions).

The specific advantages of the GFR are the following: knowledge and operating experience acquired with GCRs, twofold concept allowing the nuclearization of high-performance modern technologies developed outside the nuclear field, and progressive transition via the HTR-type thermal GCR fleet that will precede it.

Twofold challenge of fast spectrum and high temperature conditions

To address the twofold challenge of fast spectrum and high temperature conditions, the GFR possesses advantages inherited from modern HTR concepts, *i.e.*, combination of a chemically inert coolant (helium) transparent to neutrons (no capture, little diffusion, no activation, even at pressures of several tens of bar) with a refractory and mechanically robust core using “cold” fuel and locally confining FPs at high temperatures. This combination makes it possible to benefit from the decoupling of neutronics and thermohydraulics, and thermomechanics and chemistry. The design of nuclear reactors is determined by the analysis of failure modes associated with couplings of neutronics, thermohydraulics, material mechanics and chemistry.

The benefits of said decouplings, associated with a more efficient fuel, manifest themselves under both normal and accident operating conditions.

The helium flow path in the core can be modified beyond a minimum core volume without significant disturbance of spectrum, capture and leak conditions. Together with the possibility of significant increases in core temperature, this property allows for reducing the pumping power under normal operat-

ing conditions and favors gas convection in residual power evacuation situations.

The practical exclusion of **recriticality*** accidents through the insertion of reactivity exceeding the **delayed neutron*** fraction constitutes a significant advantage for the design of a fast neutron reactor concept subject to increased core sensitivity (namely due to the loading dominated by plutonium, which reduces the delayed neutron fraction β_{eff}^* , and also due to the short lifetimes of **prompt neutrons*** under fast spectrum conditions, *i.e.*, approximately one microsecond). The increase in reactivity due to depressurization can be limited by design to a value less than β_{eff} .

The use of a chemically inert coolant makes it possible to benefit from the refractory and mechanical robustness qualities of the core. In severe accident situations, an additional margin of a few hundred degrees is guaranteed beyond the fission gas containment limit (*i.e.*, before extended core degradation leading to a loss of geometry inhibiting core cooling in the long term, or to a core collapse possibly resulting in a significant release of energy due to recriticality).

Helium is not activated under neutron flux. It is chemically inert and, if pure, does not contribute to structural corrosion or activation. This advantage has been confirmed in HTRs. Combined with the HTR fuel containment quality, it has led to very satisfactory operating experience in terms of doses. It is particularly advantageous in the hypothesis of reactors operating on a direct cycle with gas turbines.

It is therefore possible to benefit from the remarkable increases in efficiency and competitiveness achieved by fossil fuel plants over the past decades with conventional industrial coolants (gas and steam or supercritical water). This is particularly clear in the case of gas turbines.

The GFR system combines high thermodynamic and neutronic efficiency. It is a modern and competitive technology capable of following up on progress with fossil thermal systems (particularly as regards coal, a potential competitor in the long term). It guarantees a sustainable development of nuclear energy by maximizing the use of uranium resources through industrially optimised plutonium recycling.

Specific problems associated with the GFR

These problems are due to the above-mentioned twofold objective (high temperatures and fast spectra) and mainly concern the following: fuel and structural materials under flux; economic fuel reprocessing and fabrication; and evacuation of residual power under loss-of-pressure accident conditions. They can be overcome through a combination of technological innovation and optimised reactor design.

A steel-clad pellet-type fuel with large volumes of fission gas expansion outside the core, such as that developed for sodium-cooled fast reactors, can be adapted for a GFR core. However, it does not provide the second set of properties sought, characteristic of micro-confining, refractory (cold) and mechanically robust fuels such as the graphite matrix particle fuels tested up to very high burn-up fractions under thermal spectrum conditions in HTRs. Due to the damage associated with fast spectrum irradiation, and given the power density sought, these fuels are not usable as such in a GFR system. In addition, imposing fission gas retention within the core volume leads to a diluted core and makes it more difficult to obtain a hard spectrum. Adapting such concepts, modifying the materials and ensuring competitive fuel reprocessing and fabrication is therefore one of the greatest challenges for the GFR. The same applies to the core structures and, more generally, the flux-exposed structures.

The need to evacuate residual power under loss-of-pressure accident conditions with loss of nominal forced gas convection contributes to the design of the backup systems. The combination of high specific power (aimed at minimising the plutonium inventory required for a given power output) and high concentration of fissile nuclei (aimed at hardening the spectrum) imposes a power density of between 50 and 100 MWth/m³. Correlatively, the thermal inertia of the core and structures (thermally coupled) is reduced as compared to HTR systems. As a result, the GFR cannot copy the solution implemented in HTR systems, which is primarily based on thermal inertia. It is necessary to use gas convection, maintaining a backup pressure capable of ensuring minimum thermal efficiency for the coolant.

In a high-power core, with moderate power density compared to that of conventional water-cooled reactors, increasing the core fraction reserved for the coolant has little impact on spectrum hardness and reactivity. We can therefore consider a “porous” core with low hydraulic resistance but still mechanically robust. Satisfactory gas convection for residual power evacuation as per admissible core outlet temperatures can be ensured for a core power of approximately one electric gigawatt through the use of backup systems pumping requiring approximately 100 kilowatts, assisted by natural convection capable of taking over after a few hours.

Advantages inherited and imported from other technologies

The advantages of the GFR system have two main origins

Firstly, the genealogy and operating experience of the GCR series are very significant (Fig. 98). In addition to the AGR, this particularly includes the AVR (pebble-bed HTR), which operated for approximately 20 years and sustainably achieved core outlet temperatures of 950 °C. It also includes the reactors of the NERVA nuclear space propulsion program, which achieved exceptional performance in terms of hydrogen outlet temperature (2,500 °C) and power density (4,000 MW/m³) due to the absence of industrial constraints regarding cost, lifetime and safety. The most powerful reactor of the series had a total power output of 4.3 GWth, close to that of the EPR.

Secondly, significant scientific and technological progress has been achieved regarding high temperature and fluence materials, and also high-temperature mechanics. In addition, at the system level, the benefits of the twofold concept enable the exploitation of high-temperature technologies, particularly for gas turbines.

Jean-Baptiste THOMAS,
Simulation and Experimental Tools Directorate

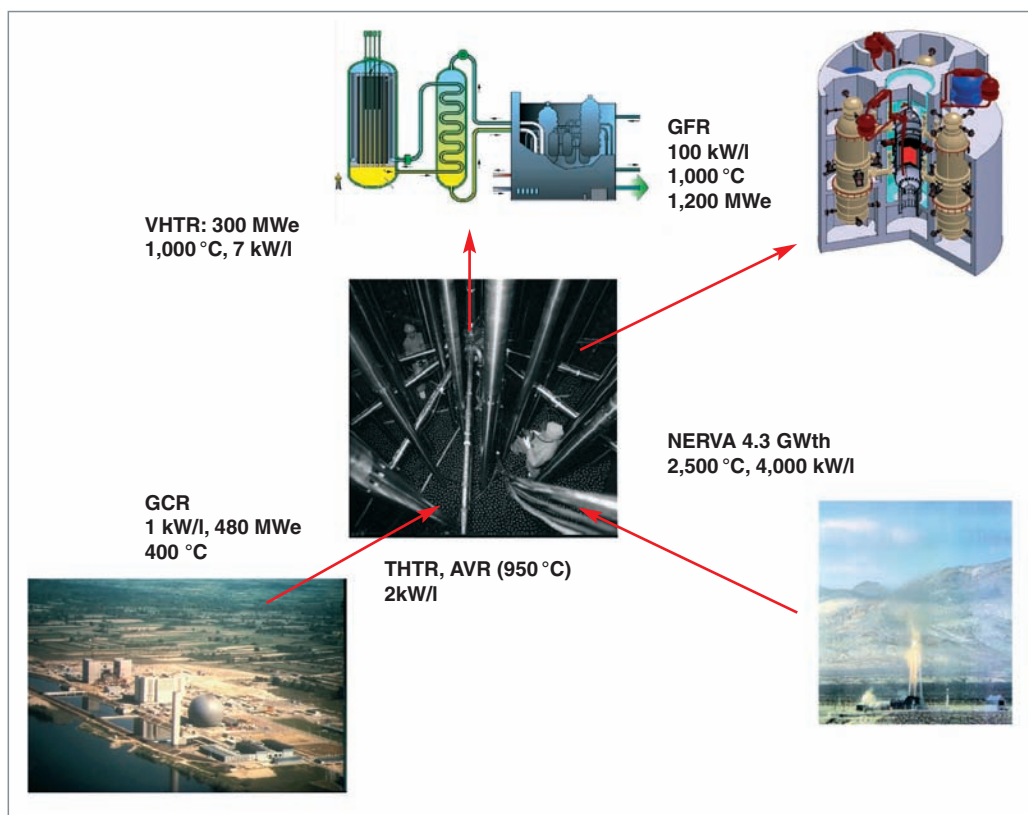

Fig. 98. Genealogy of gas-cooled reactors.

Transition from a water-cooled reactor fleet towards a GFR fleet

The transition from a worldwide conventional water-cooled reactor fleet supplying 90% of electronuclear energy towards a GFR fleet ensuring optimised fuel cycle closure could be carried out according to three distinct options, depending on the energy requirements schedule and the evolution of the raw materials market.

The first option, technologically cautious, would consist of developing moderate-temperature GFRs based on the knowledge and operating experience acquired with AGRs, GCRs, past prototypes (German, USA, Japan) and SFRs (core, fuel fabrication and reprocessing). The progress achieved in terms of regeneration would then be given priority with respect to high temperatures.

The second option would consist of directly transposing the advantages of the HTR to fast spectrum conditions, in combination with competitive fuel recycling. This is the option followed in the Generation IV program.

An evolutionary and more technologically progressive approach could be adopted based on the VHTR. This third option would consist of adapting the VHTR to very high conversion ratios without sacrificing high temperatures. If VHTRs were to significantly penetrate the market (as of 2030, for example), they would be faced with an increase in the cost of natural uranium before the end of their lifetime, resulting in a general need to increase the **conversion ratio***, hence the objective of a U-

Pu cycle with hardened spectrum. VHTRs would then possess two major advantages:

- Stepping stone of a field-proven and flexible reactor series with a competitive thermal spectrum and high potential for adaptation to sustainable development criteria.
- Decoupling of coolant function and neutron slowdown, characteristic of GCRs, allowing the achievement of a conversion ratio above 0.8.

In addition to accumulating the operating experience from precursor nuclear systems (slow neutron reactors and plants), this evolutionary approach would allow large-scale recycling, characterized by the preservation (or increase) of the fissile material inventory, the preservation of plutonium quality, and the production of a major portion of energy from recycled nuclear materials.

The availability of a competitive HTR system (reactor and cycle) is a preliminary condition for the emergence of GFRs. HTRs and VHTRs (probably adapted and optimised) should provide this basis. Subsequent evolutions conditioned by the progressive increase in resource prices should orient and promote developments leading to isogeneration/breeding recycling and uranium/plutonium recycling under fast spectrum conditions.

GFR core design and behavior

GFR core design

The GFR system aims to achieve high efficiency with a core-outlet helium temperature of 850 °C. This requires selective specifications in terms of fuel and structural materials, and design choices that differ markedly from known solutions.

As in the case of Pu fuels, the GFR fuel is expected to be expensive, hence the objective to extract a maximum amount of energy from a minimum amount of fuel by using a high power density. There is also an economic argument for this objective. The core dimensions affect the cost of the nuclear steam supply system, particularly in terms of reactor vessel diameter and height. On the other hand, it can be easily seen that such an approach has its limitations, since heat exchanges within the core must remain compatible with material usage constraints (cladding, fuel, etc.). Given the challenges posed by a high-temperature reactor, a power density comparable to that of PWR cores is sought for the GFR, *i.e.*, in the order of 100 MW/m³.

The objective in terms of uranium and plutonium conversion is particularly ambitious: **isogeneration***. This objective may appear modest but it should be viewed in the context where we preclude use of fertile blankets (For example, in Superphenix, designed for breeding, the internal conversion ratio was 0.84 and reached 1.24 when fertile blankets were included) [1]. The GFR system is considered in the framework of an innovative non proliferation system which avoids U/Pu separation and which is fueled only with natural or depleted uranium together with recycled minor actinides (Np, Am, Cm) with the Pu, *i.e.*, a cycle well suited for fuel reprocessing and refabrication operations but not applicable to a significant blanket load such as that used in Superphenix.

Isogeneration affects the core design, as it requires a fuel with low enrichment (for an FBR), *i.e.*, a Pu/(U+Pu) ratio of between 15 and 20% using plutonium of moderate quality obtained from spent fuels of PWRs. In particular, this specification eliminates the possibility of using significant quantities of excessively absorbent materials such as refractory metals Nb, Mo or W. It leads to choosing very dense fuels such as carbide or nitride ceramics, preferably with oxide additives. This approach is facilitated by the choice of a high-power reactor.

As part of the exploratory design stage, CEA research teams have defined a consistent set of design options. We can thus imagine a high-power core (2,400 MWth, *i.e.*, approximately 1,200 MWe) in the form of a flattened cylinder with height $H = 1.6$ m, diameter $F = 4.5$ m, and a fuel region surrounded by a neutron reflector. Its lifetime would be 5 to 10 years, depending on the burn-up fraction sought. It would consist of assemblies with hexagonal cross-sections, designed to meet mechanical integrity requirements during operation. The core must be sufficiently porous to allow the passage of the reactor coolant with moderate head loss (upward flow, head loss less than 0.5 bar), *i.e.*, with a ratio of gas volume fraction to total core volume of approximately 40 to 50%. In terms of neutronics, it is imperative that the fuel volume fraction remain high (between 20 and 25% of the core volume), thereby ensuring the Pu concentration required for criticality, while maximizing the U concentration. Indeed, the lower the Pu/(U+Pu) ratio, the higher the **conversion factor***.

Figure 99 shows a schematic view of the fuel assembly for a configuration where the fuel element consists of a flat plate. An optional configuration with a rod-type fuel element is also considered. Figure 100 shows the core loading pattern.

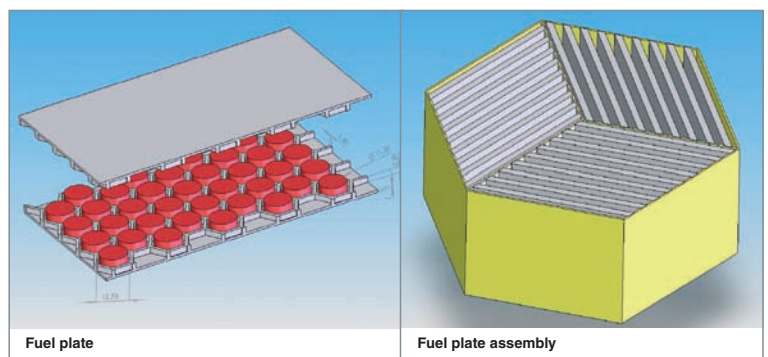

Fig. 99. Schematic view of the GFR fuel plate and fuel assembly.

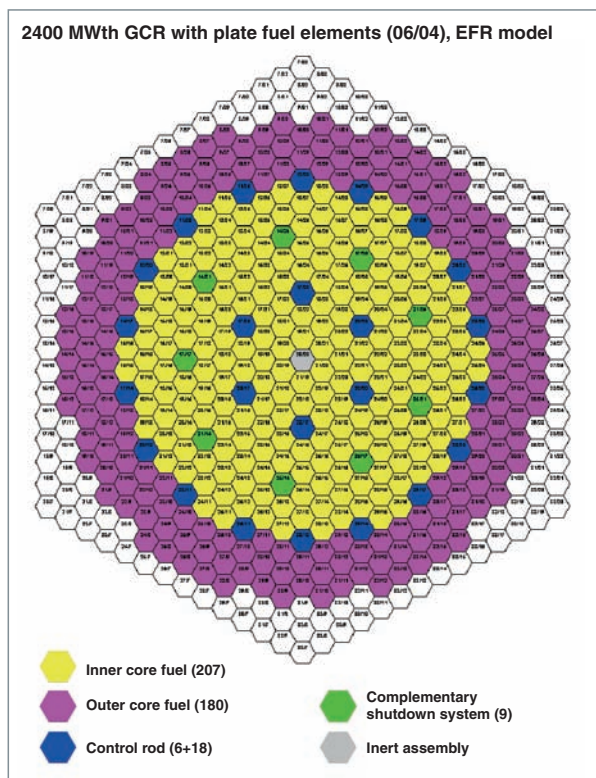

Fig. 100. 2,400 MWth GFR core loading pattern.

Thermal counter-reactions and reactor safety

In a nuclear reactor in stationary regime, the production of neutrons very exactly balances out the disappearances. The core reactivity can reflect a possible deviation from equilibrium, with a positive **reactivity*** leading to an increase in power and, inversely, a negative reactivity leading to a decrease in power. The consequence as regards thermal exchanges will be an increase/decrease in core temperatures, more or less pronounced depending on the core reactivity and thermal inertia. The coupling of neutronic and thermal characteristics can be described as follows:

- Doppler effect: the thermal motion of nuclei affects their nuclear properties by widening their absorption resonances, thus increasing or reducing the probability of neutron/matter interaction. This phenomenon involves the various nuclei and nuclear reactions (fissions, captures, etc.). In practice, it is dominated by the capture of U 238, with an increase in fuel temperature corresponding to an increase of U 238 captures and therefore a decrease of reactivity. The Doppler effect therefore has an immediately stabilizing effect governed by the fuel temperature;
- Drainage effect: in-core temperature and pressure conditions determine the coolant density, which is itself conditioned by neutronics (spectrum effect and leakage). In a pressurized

reactor, the risk of brutal depressurization justifies devoting increased attention to the corresponding reactivity effect. In the case of the GFR, this effect may be slightly positive. The first transient calculations show that the global effect is low, with depressurization accompanied by heating of the fuel (which activates the Doppler effect);

- Thermal expansions of the structures or fuel cause a variation of the apparent core volume. The associated reactivity effects are significant in a fast neutron reactor. They consist of stabilizing effects observed over a long time constant, with radial expansion governed by the expansion of the core support structure, and axial expansion governed by the expansion of the fuel or cladding.

In the end, and regardless of the initiator, a set of thermal counter-reactions ensures the coupling of neutronic and thermal characteristics. Under the effect of a disturbance, the core reaches a new equilibrium state with zero reactivity, provided the power evacuation systems accommodate this operating point. These stabilizing effects very directly condition the control and safety of reactors. They are observed in all types of nuclear reactors, at varying degrees (for example, the Doppler effect is more pronounced in slow neutron reactors). [Table below shows a comparison of the intensity of these effects in the GFR and SFR.](#)

Reactivity effects in a GFR and SFR		
	GFR	SFR
β_{eff}	350 pcm	350 pcm
Doppler	-1,000 to -1 500 pcm	-700 to -900 pcm
Drainage	< 350 pcm	<1,500 pcm

In the GFR, the use of ceramics rather than steel for the core structures accentuates the Doppler effect due to the slightly slower neutron spectrum. The availability of significant thermal margins and their combination with strong counter-reaction effects allows for reduced requirements regarding the reaction time of protection systems, and it confers robustness against transients for which the emergency shutdown system does not provide immediate protection. Based on these principles, the low-power “Rapsodie” prototype (SFR) with natural convection capability and strong counter-reaction effects has successfully undergone a test to demonstrate reactor coolant pump shutdown without control rod drop.

From the neutronic perspective, GFR control will be facilitated by the absence of **Xenon effect*** and by a low sensitivity of the **power map*** to possible local effects. Likewise, the small variation in reactivity during an **isogenerator*** core fuel cycle may be compensated by the control rod system, with low insertion minimising the risk associated with inadvertent rising of the rod.

Overview of research concerning the GFR core

The preliminary design studies constitute an absolutely essential upstream component of the research program conducted at the CEA regarding the GFR. These pluridisciplinary studies (neutronics, thermohydraulics, mechanics, safety, etc.) orient R&D activities and confirm system potentialities. For the core studies in particular, we have proceeded in three successive steps.

Exploratory design studies

The objective here was to verify the existence of solutions through initial parametric studies. The parameters explored were core geometry and composition, and also fuel type. We were able to confirm that the goals sought for the GFR core could be achieved, and valuable lessons were drawn for subsequent studies, particularly as regards the pre-selection of fuel materials and concepts.

In addition, these studies have clearly shown the importance of the “core power density” parameter. A low power density facilitates fuel cooling but, on the contrary, penalizes the plutonium inventory and the economy of the system. It has therefore been decided to privilege a high value, provided that fuel feasibility and cooling can be justified under all circumstances. A value ranging from 50 to 100 MW/m³ has been chosen for subsequent studies.

Feasibility study

This study consists of analyzing the core thermohydraulic and neutron design parameters. The large number of parameters involved (more than 10) poses a difficulty. We have therefore sought to rationalize the design approach. The methodology adopted is presented below with an application example.

Regarding neutron design, the objective is isogeneration. The preliminary choice of unit power and power density determines the core volume. For a given core volume, the choice of core height-to-diameter ratio (H/D) affects the leakage rate in the neutron balance and constitutes an adjustment parameter for

obtaining isogeneration (reducing the leakage rate facilitates uranium conversion under otherwise identical conditions).

Likewise, the neutron balance is significantly affected by the core composition, *i.e.*, volume fractions of fuel, structural materials and gas. For a given core volume and fuel volume fraction (and therefore gas volume fraction, with the structural volume fraction considered as invariable), there is an H/D ratio above which isogeneration cannot be achieved. By performing a series of core neutronic calculations (using the ERANOS program), we can build a curve of minimum admissible H/D values as a function of the gas fraction (z).

At the same time, we define decoupling criteria to make progress with the thermohydraulic aspect of the study:

- Maximum fuel temperature under nominal and accident conditions (decoupling with respect to refined fuel element design/dimensioning studies): 1,200 and 1,600 °C, respectively;
- Head loss (decoupling with respect to backup and power evacuation system design): 0.5 bar.

Regardless of the concept considered, we seek to minimise the core head loss by choosing the largest hydraulic diameter compatible with the maximum fuel temperature criterion. For a given hydraulic diameter, increasing the H/D ratio increases the core head loss (reduction of cross-sectional flow area, increase of velocities and contact length). We can conceive the existence of a maximum H/D value compatible with the predefined head loss criterion. The COPERNIC program has been developed to automate these searches for optimal values. We were thus able to build curves of maximum admissible H/D values as a function of the gas fraction.

The juxtaposition of the two neutronic and thermohydraulic limits in a same graph (H/D vs. gas fraction) defines a feasibility domain (possibly inexistent, depending on the initial power, power density and composition data). Figure 101 shows the example of a 2,400 MWth using CERCER fuel (fissile phase UPuC dispersed in a SiC matrix). To the left, the power density chosen is 56 MW/m³. The feasibility domain is very broad. To

Initial selection of concepts and materials			
Fuel concept	Plate block or bundle	Pellet bundle	Particle bed
Matériau du combustible	CERCER Ref. solution: (U,Pu)C - or (U,Pu)N – and SiC matrix (+ study on ZrC and TiC) Other possibility: (U,Pu)N and TiN matrix (+ study on ZrN)	(U,Pu)C, and (U,Pu)O ₂ as fallback solution	Same as for block or plate
Structure material (cladding, assembly housing)	Identical to matrix	SiC	SiC

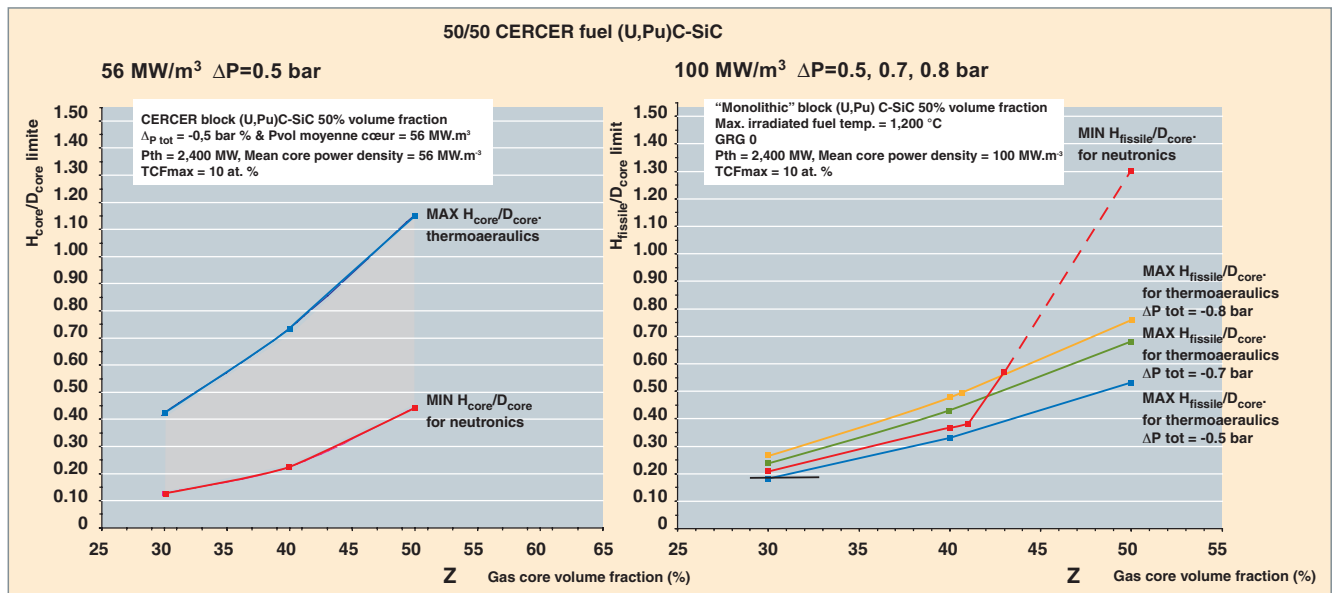

Fig. 101. 2,400 MWth GFR core feasibility domain.

the right, the power density chosen is 100 MW/m³. The min. and max. H/D curves are contiguous. Assuming the head loss limitation (0.6 bar) can be raised, the curves intersect and the feasibility domain is reduced to a few points, corresponding to the only possible core(s).

This study has enabled progress in the design of GFR cores. In addition to a better understanding of the challenges involved, we now have a general view of the configurations of interest, allowing us to orient future R&D activities.

Reassembly and characterization study

The core and fuel design options have been limited to a few configurations of interest. In-depth studies concerning the fuel (thermomechanics) or reactor (safety) may be conducted.

The reassembly phase is intended to enhance the concept by integrating the teachings from related studies. For example, the use of SiC/SiC fiber-reinforced composites is limited to structures with thicknesses greater than 1 mm. Starting from an initial design formulated in early 2004, the core design has evolved to take into account this limitation and others (see Table below).

GFR core with plate fuel (summer 2004)	
	2,400 MWth GFR
Power (MW)	2,400
Power density (MW/m ³)	100
Temp. hélium entrée/sortie (°C)	480 / 850
Inlet/outlet He temperature	CERCER honeycomb (U,Pu)C _{56%vol.} + (SiC+clearances) _{44%vol.}
Assembly technology	Plate in hexagonal housing SiC/SiC fiber-reinforced structures
Plate thickness (mm)	7.00
Max. wall/fuel temperature (°C)	1,075*/1,210*
Core head loss (bar)	0.6*
Pu/U+Pu content (%)	15.2
BU _{mean / max} (at. %)	10.1 / 14.7
Max. dose (dpa SiC)	163
Doppler effect (pcm)	- 1,175
Effect of He depressurization (pcm)	+ 253

*Calculation performed using the COPERNIC computer code.

This reassembly phase involves complex processes (material properties, safety, complex calculation chains) and will therefore extend over time as per the concept development schedule.

The purpose of the characterization study is to establish the data sheet for the core considered. It consists of conducting additional studies on issues deemed important for GFR feasibility. For example, regarding the fuel cycle, a fuel multirecycling simulation has been performed for the core described above (irradiation, cooling, reprocessing-fabrication, re-irradiation, etc.). The fuel composition evolves and then stabilizes. The ability to sustain the fuel cycle with only natural uranium (isogeneration) is verified. The core characteristics (start-of-cycle reactivity, Doppler effect, helium depressurization) also differ from the first cycle calculations. The absence of specific problems due to these new characteristics is therefore also verified.

Preliminary safety calculations have shown a limited effect for steam ingress (the effect is even negative for the expected concentration). The safety calculations must be supplemented and refined through iterations as the core design progresses.

In agreement with the equivalent fuel and reactor design studies, these core design studies aim to produce a preliminary GFR feasibility report in 2007.

Qualification of tools and data

Specific requirements regarding the qualification of methodologies and data will arise to develop the low-power **REDT*** reactor. The experimental tools required for these qualifications have been identified and the corresponding test programs have been outlined. In particular, we note the ENIGMA program for the MASURCA critical model (Fig. 102), aimed to control core neutronics (impact of ceramic structures, heavy reflector, leakage, helium depressurization, etc.) and finally justify the uncertainties associated with the various core parameters. At the same time, we plan to implement new experimental thermohydraulic tools (analytical test benches using air and then helium) intended to complement the design work through experimental verifications, qualify thermal exchange or head loss correlations, and test a model of the REDT assembly (with helium and in final configuration).

► Reference

[1] J. BUSSAC, P. REUSS, "*Traité de neutronique*", éditions Hermann.

Jean-Claude GARNIER,
Reactor Research Department

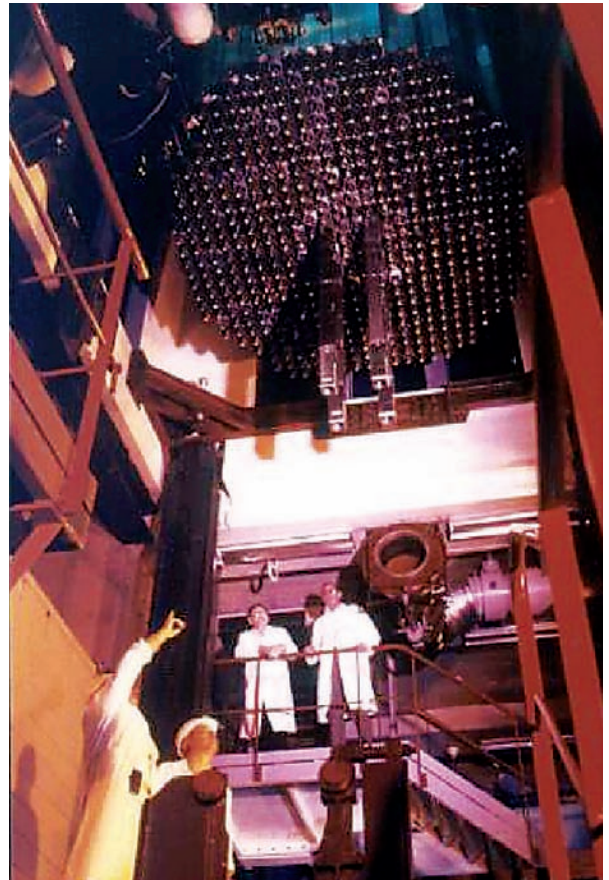

Fig. 102. MASURCA critical model (Cadache).

GFR safety

Safety approach

As in the case of the other systems selected by the Generation IV International Forum, the technical objectives for the GFR system are globally consistent with those specified by the French safety authority [1]:

- Control of nuclear and chemical reactions;
- Controlled evacuation of the energy generated;
- Controlled containment of hazardous products;
- Control of personnel protection;
- Control of effluents and waste, to ensure the protection of populations and the environment.

These functional objectives are supplemented by probabilistic objectives. These include a global probability (internal and external initiating events) of core degradation with significant release of fission products (in the order of 10^{-5} per reactor per year), and a probability of significant release outside the last

barrier (in the order of 10^{-6} per reactor per year). The sole purpose of these figures is to assist designers in selecting the relevant number of functional redundancies to be implemented to ensure the functions listed above.

The list of accident-initiating events associated with a new reactor project depends on the level of detail achieved in the reactor design and on an intuitive understanding of the resulting scenarios. The initiating events are classified according to frequency of occurrence, which is difficult to determine for reactor projects without operating experience feedback. An initial, non-exhaustive list is shown below (Fig. 133), in relation with residual power evacuation. These are major initiating events leading to an abnormal increase in fuel temperature.

For example, gas leakage leading to loss of pressure appears in seventh position. The scenario for this accident will be covered below as an example.

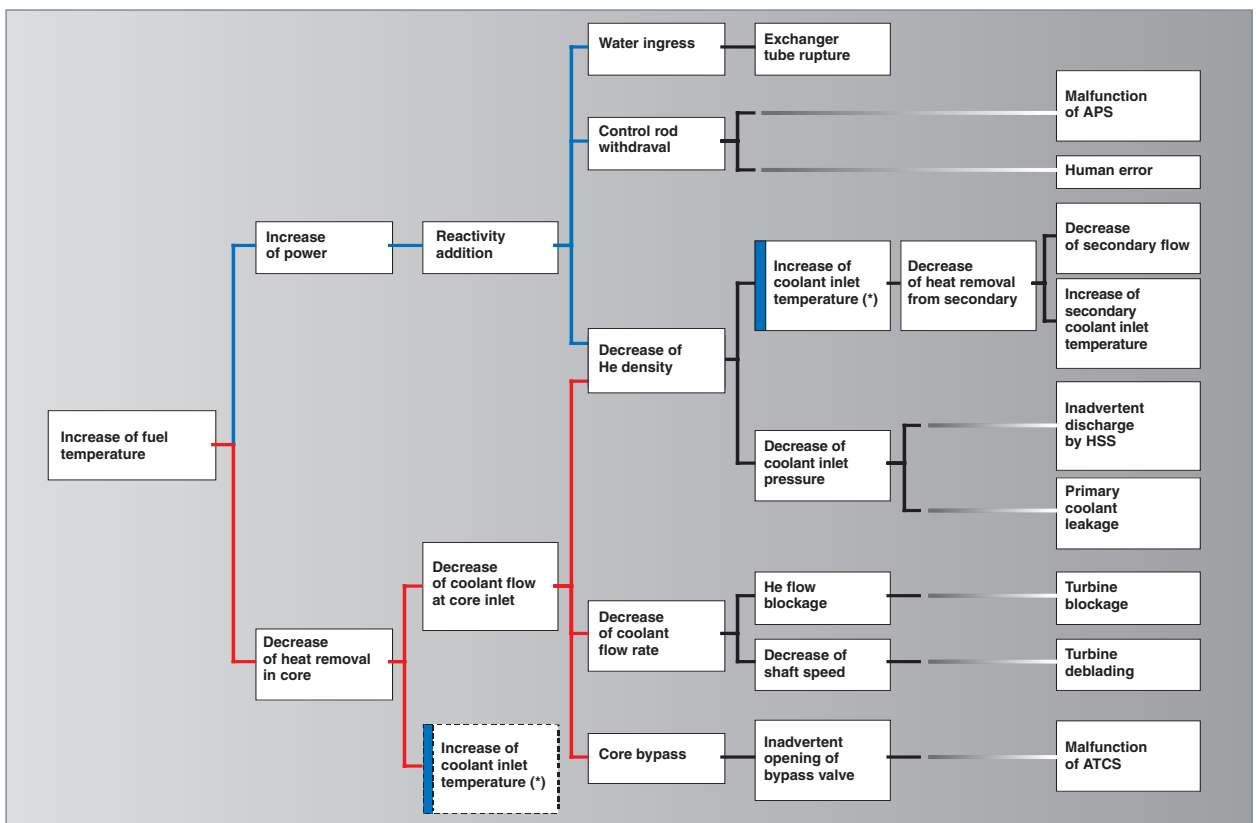

Fig. 103. Simplified tree structure of initiating events leading to an abnormal increase in fuel temperature.

Engineered safeguard systems

The engineered safeguard systems proposed must satisfy the technical safety objectives for a nuclear reactor. The principle of the solutions currently adopted is indicated below for each objective.

For controlled containment, we apply the three-barrier principle: fuel coating or cladding, vessels/primary circuit, and containment. The adoption of a proximate containment to ensure the emergency pressure constitutes a fourth barrier offering additional potential guarantees.

The reactivity control measures adopted consist of a fuel assembly design guaranteeing the geometric stability of core power, a fuel offering a favorable natural behavior with stabilizing neutronic counter-reactions, and two diversified and redundant control rod systems acting according to a gravity drop principle.

For heat evacuation control, two independent and individually redundant residual power evacuation systems are used: a passive system operating by natural convection and using a proximate containment in case of a large break in the primary cir-

cuit, and an active system using blowers capable of maintaining a minimal gas flow rate through the core (Fig. 104).

To control chemical reactions, we can consider inertializing the proximate containment during operation, which avoids having to control the oxidization of the structures due to air ingress in case of a large break in the circuit.

Loss-of-pressure accident

Gas cooled reactors theoretically present a significant sensitivity to possible coolant leakage. A gas may leak more easily than a liquid, and its high pressure and temperature favor the development of leak points (cracking of containment structures, rupture of pipes). In case of significant gas leakage, the heat produced in the core must be evacuated before unacceptable temperatures are attained. To assess the ability of a given reactor concept to ensure this safety function, we first analyze its behavior for the major initiating event enveloping most incidents and accidents associated with the loss of coolant, *i.e.*, rapid pressure loss due to a large break in the circuit.

In modular HTRs (*e.g.*, GT-MHR, PBMR), the design solutions to limit the impact of the accident are twofold: on the one hand,

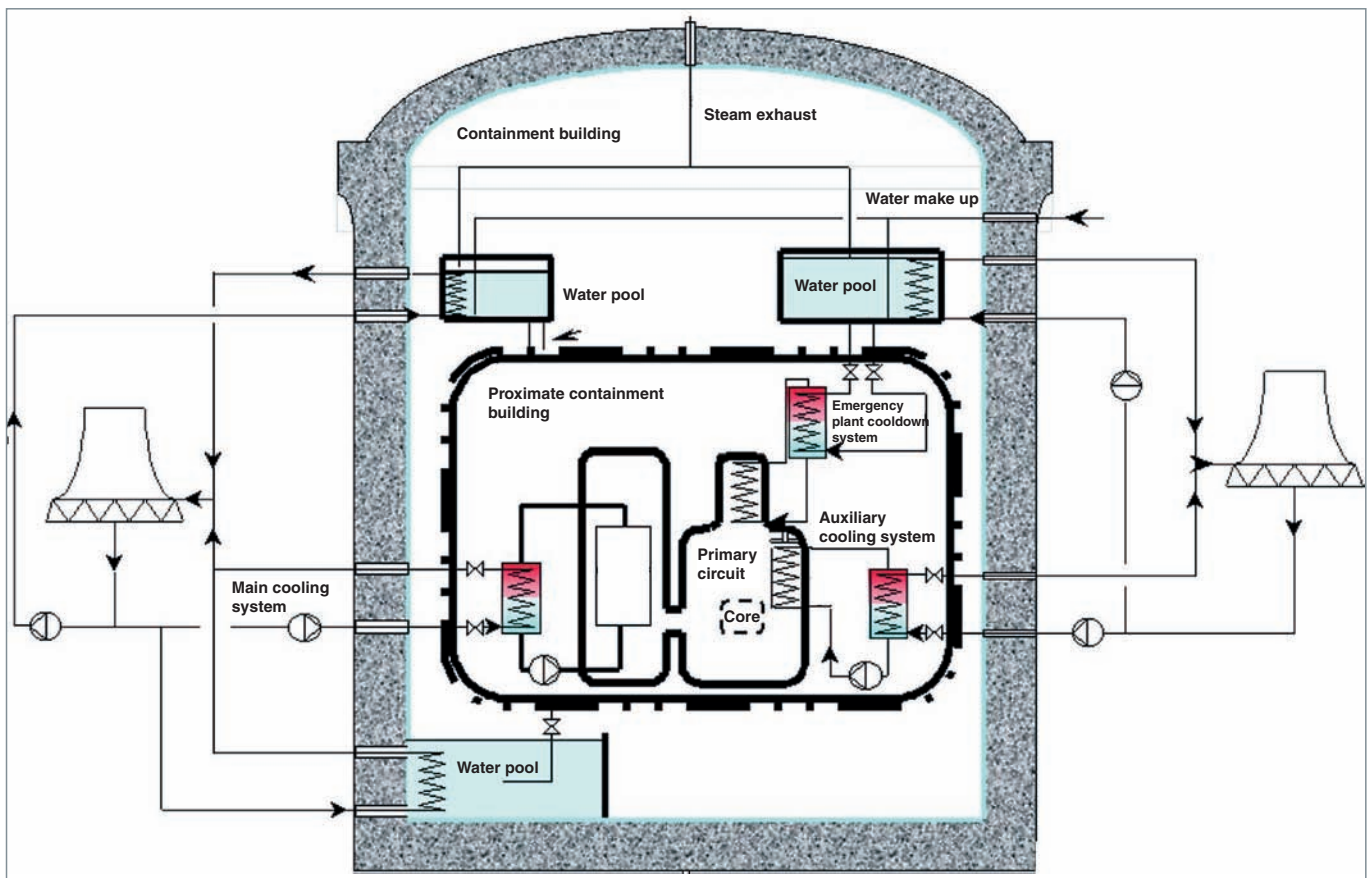

Fig. 104. GFR with engineered safeguard systems.

using a low unit power (which limits the core volume) and low power density (which dilutes the fuel) and, on the other hand, compensating the loss of thermal capacity of the gas by using the thermal inertia of a large volume of graphite also serving as moderator.

For GFRs or HTRs with high unit power, past solutions consisted of using a concrete vessel to limit the size of the breaks and using a heavy gas, generally carbonic gas, at moderate temperature.

In the case of future GFR systems, the fast spectrum causes the elimination of the graphite in the core and significantly increases the power density. Moreover, the high efficiency objective requires a high-temperature inert gas. The design of such systems therefore requires new solutions to limit the impact of a rapid pressure loss.

Rapid pressure loss scenario

A large break causes a rapid decrease in circuit pressure (typically within 5 to 40 seconds) to an emergency pressure imposed in a sealed, external, proximate containment. The rods drop and the core shifts to residual power.

The power delivered by the core as a function of time approximately follows the curve $P/P_N = 0.15 \cdot t^{-0.28}$, where P_N is the nominal thermal power of the reactor (see Table below).

Residual power vs. nominal power after reactor shutdown, as a function of time

Time	1mn	2mn	4mn	10mn	20mn	1h	4h
P/P _N	5%	4%	3%	2,5%	2%	1,5%	1%

At the same time, the gas evacuates its heat through natural or forced convection via a gas/gas or gas/water heat exchanger located in the upper part of the vessel. The transition between the coolant's nominal circulation regime and the new convection regime at emergency pressure takes place in a very short time.

The goal here is to determine whether the natural convection of the gas suffices to evacuate the power delivered by the core, and thereby design the emergency systems. Multiple criteria are to be satisfied. With cooling subject to no intervention during the first instants (typically 30 min.) and subsequently ensured without the use of heavy external means in the medium term (a few days), the maximum transient fuel temperature must not exceed 1,600 to 1,800 °C. The maximum temperature for structures outside the core must not exceed 1,200 °C over a limited time period.

Emergency pressure

The core thermohydraulic calculations performed at the CEA using the CATHARE code show that the emergency pressure must range from 0.7 to 2.5 MPa (depending on the criteria adopted and the gas used) in order for natural convection to suffice to evacuate the residual power.

Such a pressure requires a sealed, proximate containment to contain the leaking gas.

Figure 105 shows the values obtained as a function of gas type and power level to be evacuated for a core power density of 103 MW/m³.

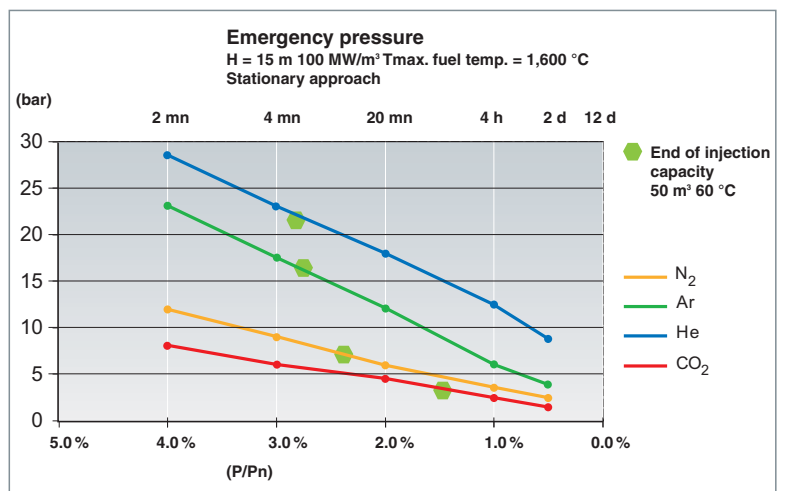

Fig. 105. Emergency pressure required to evacuate the residual power through natural gas convection, as a function of the type of gas injected. P/P_N (x-axis) is the ratio between the residual power to be evacuated and the nominal power of the reactor. The green point on each curve corresponds to the pressure attained in the emergency containment after injecting 50 m³ of gas.

For helium, an emergency pressure of 1.5 to 2.5 MPa is required during the first minutes. Argon does not provide significant benefits. On the other hand, nitrogen and carbon dioxide reduce the required emergency pressure to less than 1.0 MPa.

Natural convection capacity

The same calculations can be used to fix the orders of magnitude of the natural convection capacity required to evacuate the residual power from the core. This capacity depends on numerous parameters, mainly the core power density, maximum admissible core outlet temperature, heat sink installation height (see Table below) and emergency pressure, as well as the head losses in the convection loop (particularly in the core).

Natural convection height required to achieve a given core outlet temperature (helium at 2.0 MPa) for two GFRs with different characteristics

Robuste core (50 MW/m ³), 3 % PN		High performance core (100 MW/m ³), 2 % PN	
Height	Core outlet temp.	Height	Core outlet temp.
25 m	850 °C	15 m	1,000 °C
10 m	1,500 °C	10 m	1,500 °C

Figure 106 gives an idea of the evolution of the temperature as a function of time using only natural convection after the loss-of-coolant accident.

Passive systems

The passive systems selected for the evacuation of residual power by natural convection consist of a first circuit using the reactor gas and a heat exchanger with a secondary fluid (gas or liquid) constituting the heat sink and circulating in a secondary circuit towards the ultimate heat sink.

Outline circuits have been used to evaluate the main characteristics of such components, *i.e.*, circuit dimensions, volume of heat exchangers, mean transient temperature. The following conclusions can be drawn:

- The natural convection gas/gas heat exchanger is the component to be developed in order to achieve a natural convection evacuation circuit;
- Valves are required to isolate these circuits during normal operation;

- A heat sink is required at the end of the circuit (water tank or cooling tower).

To conclude, passive systems will suffice to evacuate the residual power, provided that a sufficient emergency pressure is ensured. This will only be possible by means of a reinforced containment around the reactor. The significant cost of such a containment leads to considering active power evacuation systems.

Active systems

Forced convection requires that active systems be operational. An active residual power evacuation system generally consists of a cooling fluid (helium by default), a circulator and a heat sink. Provided a heat sink is available in the gas circuit, a flow rate corresponding to 3% of the nominal flow rate at atmospheric pressure (0.1 MPa) suffices to cool the core.

Such a flow rate can be obtained with a blower power of approximately 150 kWe/GWth. For an emergency pressure of 0.2 MPa, the blower power required is 75 kWe/GWth with a low-loss core (a few tens of kilo Pascals). For 0.5 MPa, the power required drops to 17 kWe/GWth. These low power levels enable the use of diversified blower systems with autonomous electrical power supplies.

The cooling systems considered are the following:

- Primary circuit turbomachine(s). As long as it is coupled with the generator, the turbomachine evacuates power (but a guillotine break of the connecting circuit makes it ineffective);
- Compact cooling systems similar to the GT-MHR shutdown cooling system, *i.e.*, blower and gas/water heat exchanger with water circulation in the secondary circuit. Such systems could be diversified;
- Gas injection tank, with opening system to be analyzed. Injection must take place near the core inlet to ensure operability under all circumstances.

The autonomous electrical power supply systems that could be used include the following: diesel generators (as in PWRs, but with startup reliability problems), floating batteries (as in submarines, able to produce 200 W/kg for 1 hour and allowing simple automatic activation) and flywheels (with a typical capacity of 2 kW/kg for a few minutes).

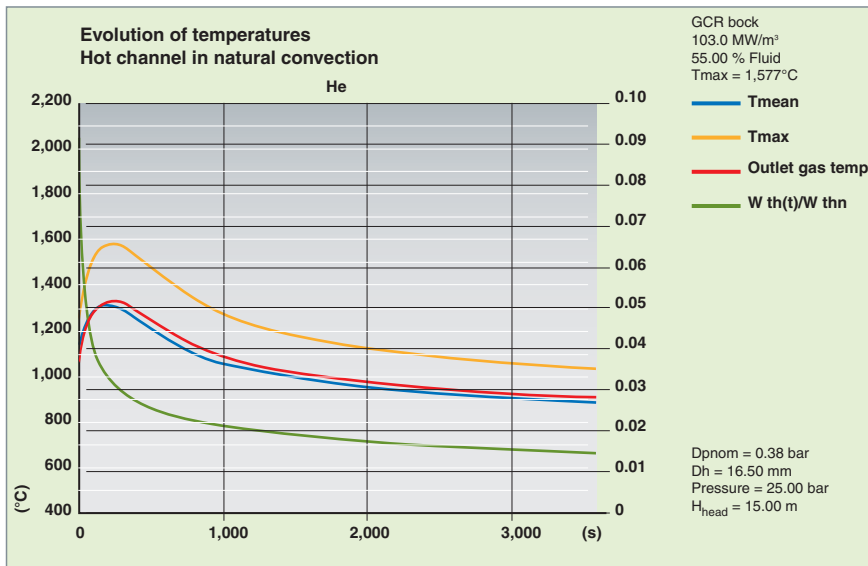

Fig. 106. Evolution of the transient temperature for a "high-performance" core (helium at 2.5 MPa) in natural convection. The maximum temperature is attained after 240 sec. The fraction of nominal power at that time is 3.1%. The decrease in temperature is slow despite the pressure being maintained at a constant level.

Reactivity accidents

Abnormal variations in core reactivity also constitute a significant point for the reactor core design. Water ingress into a fast neutron reactor core is to be feared in particular, since water moderates the neutron energy, increasing the plutonium fission cross section and therefore increasing the core reactivity.

Calculations performed on a 600 MWth core show the specific behavior of gas-cooled fast neutron cores. Water ingress of limited volume decreases the core reactivity, since the capture cross sections in the absorption **resonances*** increase more rapidly than the fission cross sections with low water content. It is only at very high quantities, typically corresponding to a volume percentage greater than 70%, that the core becomes over-reactive and the water can trigger a power excursion (Fig. 107). These results should nevertheless be considered with great caution, since the calculation of the corresponding situation is one of the most difficult for the simulation tools. The strong variation of the neutron spectrum between the initial dry core situation and the wet situation, and the current absence of specific data regarding the exact core geometry and the arrangement of the various materials generate significant uncertainties that will be progressively eliminated as the reactor design progresses.

The reactor design must take this phenomenon into account by eliminating risks of massive water ingress through a suitable arrangement of water-containing circuits, and possibly by introducing a neutron poison in these circuits to limit water ingress consequences.

Air ingress has no direct neutronic impact, but it may possibly have a chemical effect on core materials. The absence of significant quantities of graphite is an advantage of the GFR system as compared to the HTR system. Nevertheless, the materials selected must be capable of withstanding this type of accident.

► References

[1] M. LAVERIE, *Clefs CEA*, n° 45 (automne 2001).

► Bibliography

GAILLARD (J.-P.), MIGNOT (G.), CONTI (A.), "Thermal-Hydraulic design of a Gas cooled Fast Reactor", conférence ICAPP'03, 4-7 mai 2003 (2003).

GARNIER (J.-C.), POETTE (C.), MATHIEU (B.), CONTI (A.), GAILLARD (J.-P.), "Preliminary design of an advanced gas cooled fast reactor-cores, fuel forms and primary system concepts", Conférence ICAPP'03, 4-7 mai 2003 (2003).

GARNIER (J.-C.) *et al.*, "Feasibility Study of an Advanced GFR design trends and Safety options status of France & US studies", Conférence Global 2003.

Pascal ANZIEU,

Nuclear Development and Innovation Directorate

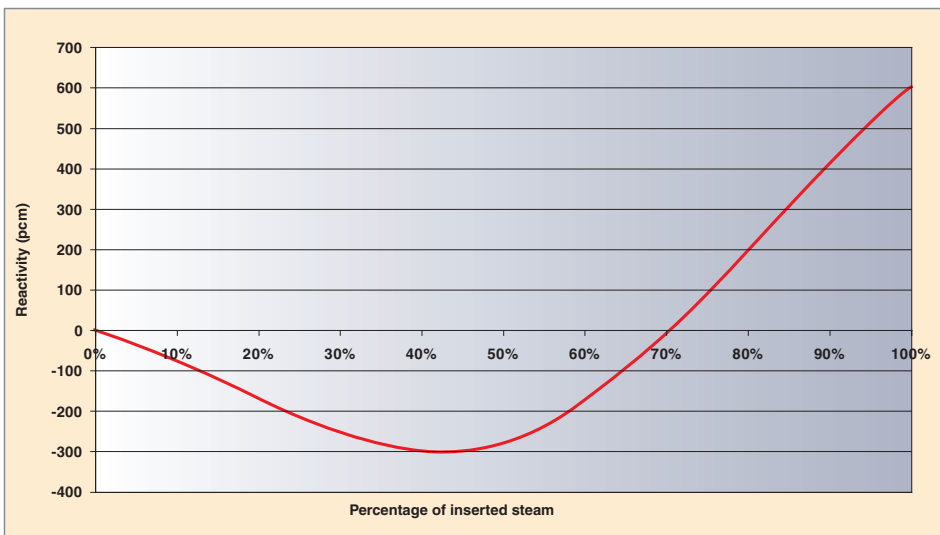

Fig. 107. Core reactivity (pcm) as a function of the volume occupied by the steam at nominal pressure (7.0 MPa). Calculation performed using the CEA's TRIPOLI code.

Materials for the GFR: New ceramics and new alloys for high-fluence applications

Core materials must meet stringent conditions

The materials composing the inert components of the GFR core, fission product containment barriers (envelopes and fuel cladding) and internal structures must satisfy a combination of particularly severe conditions. These components will be simultaneously exposed to very high temperatures and very high irradiation, including neutron irradiation. They must therefore possess significant resistance to irradiation damage, which deteriorates most material properties, and high-temperature mechanical properties to withstand operating stresses, namely under incident or accident conditions. In addition, they must be transparent to neutrons (so as to not alter the fast neutron energy spectrum), and they must have a post-irradiation radiotoxicity as low as possible (*i.e.*, low activation), a high thermal conductivity and a low permeability to fission products. These requirements further restrain the choice of materials satisfying the first two conditions (temperature and irradiation **fluence***), already far more severe than for other Generation IV HTRs, PWRs and, to a lesser extent, current FBRs (see Table below).

Preselected candidate materials

The only materials that can be considered are therefore refractory metals, ceramics and ceramic-ceramic (CerCer) and ceramic-metal (CerMet) composites, for which there is no industrial operating experience in a nuclear environment. A qualitative preselection based on these criteria has led to the identification of a rather broad range of materials to be qualified, selected and improved through current and future programs:

- **Metals:** Niobium, molybdenum and precipitation-hardened alloys, particularly TZM (Mo alloy containing dispersed zirconium and titanium carbides). The other refractory metals have an excessively low melting point (V) or an excessively high neutron absorption capacity (Ta, Re, W, Hf);
- **Ceramics:** Essentially silicon carbide (covalent composite), the carbides of refractory metals zirconium and titanium²³ (interstitial metallic composites), and Zr and Ti nitrides. All of these metals are studied simultaneously with a view to their use in massive, probably nanostructured state, and as constituents in composite materials;
- **CerMet composites:** Exploratory research has begun on Nb-30%-ZrC composites, consisting of a metallic Nb matrix containing (Zr,Nb)C particles, and on metal (Nb or Mo)/ceramic (carbide, silicide) multilayer composites;
- **CerCer* composites:** SiCf-SiC composites consist of a silicon carbide matrix reinforced with 2D or 3D woven SiC fibers. An innovative cladding solution providing high mechanical strength combined with good impermeability to fission products has recently been studied. It consists of a metallic Zr tube (ensuring impermeability) wrapped with fibers impregnated with SiC by CVD or PVD, *i.e.*, an SiCf-SiC composite ensuring high-temperature mechanical resistance.

Operating conditions (temperature and integrated dose) of GFR core internal materials, as compared to current PWR and FBR materials				
Series	Component	Conditions	Integrated dose (dpa*)	Temperature (°C)
GFR	Cladding and core structures	Nominal	100 - 200	480 – 1,000
		Incident		1,000 – 1,200
		Accident		1,600
PWR	Internals	Normal	10 – 80	≈ 300
	Fuel cladding		20	
RNR	Internals	Normal	150	≈ 550
	Fuel cladding			

23. The carbides of other refractory metals (Ta, W, Hf) are forbidden for the same neutronic reasons.

Silicon carbide and SiCf-SiC composites are currently subject to systematic studies, given the advances achieved through related research devoted in the aeronautics and space industry. However, their limitations in terms of maximum working temperature and resistance to irradiation damage have led to considering more refractory carbides as well, namely ZrC. Their mechanical properties, particularly toughness, are still inferior to those of SiC (Fig. 108), but they are highly sensitive to the powder metallurgy fabrication method, *i.e.*, the high residual porosity significantly deteriorates the toughness of the

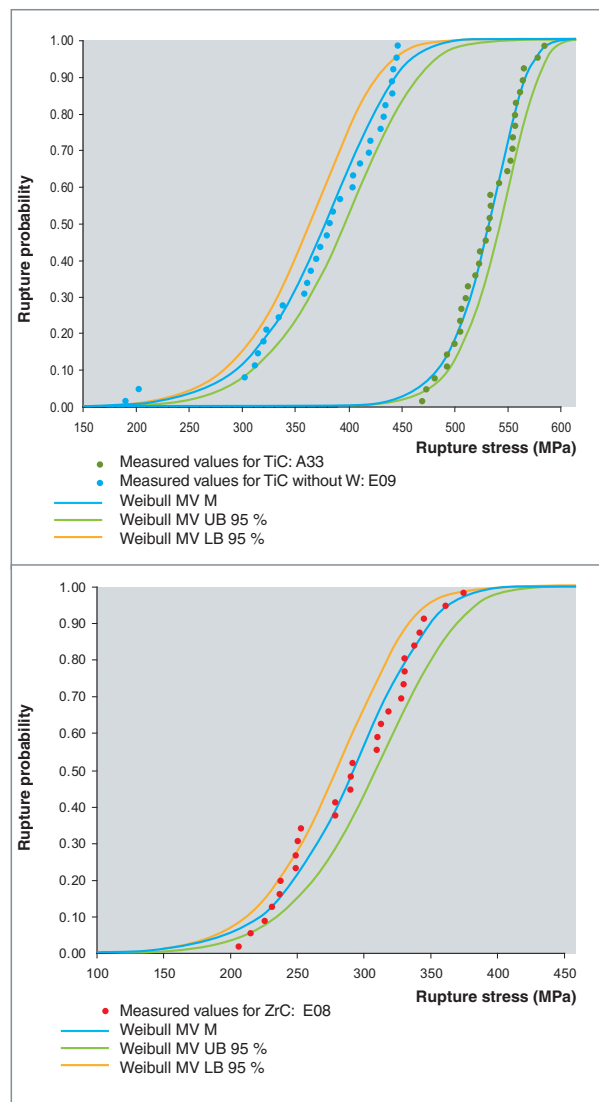

Fig. 108. Comparison of the four-point tensile rupture characteristics of refractory carbides TiC and ZrC currently fabricated by powder metallurgy (statistical Weibull curves). The toughness of TiC is significantly improved by adding W, which increases the compactness of the material after hot isostatic pressing (HIP) and thereby significantly decreases the rupture probability under a given stress. The ZrC studied still has a high porosity and appears to be as fragile as TiC without additive. The margin for progress in the fabrication process is still very large.

material. However, a more refined powder preparation method using high-energy grinding has been recently developed, allowing a compactness of 99.7% to be achieved via low-stress sintering and providing the material with a nanocrystal structure intrinsically beneficial for its mechanical behavior.

Risks undergone by the materials under irradiation

The macroscopic usage properties of solid materials, metals, alloys, ceramics and glasses are generally very strongly affected by irradiation. This is due to the creation of **point defects*** when atoms are displaced by collisions, and the microstructural modifications required to eliminate them. Ceramics, namely carbides, have been studied far less than metals. They exhibit most of the syndromes encountered in metals, namely embrittlement, irradiation creep and swelling, but at higher temperatures (due to their generally higher melting point).

Irradiation deteriorates the **mechanical behavior**. Metals harden and **embrittle**, *i.e.*, their post-irradiation tensile properties increase (yield strength in particular) whereas their **ductility*** and **toughness*** decrease. Moreover, irradiation may cause a localization of plastic deformation, leading to an inversion of global consolidation and premature rupture. Irradiation sometimes weakens the interfaces, grain boundaries and interphases in both types of materials (metals and ceramics).

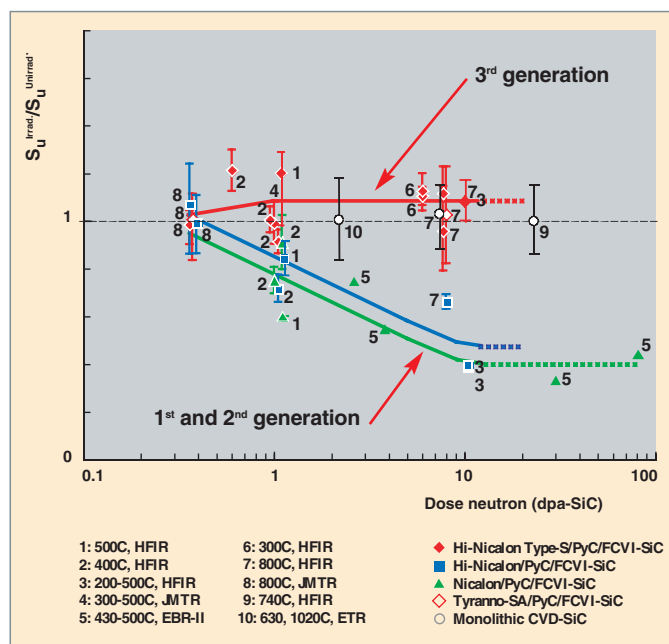

Fig. 109. Comparison of the rupture resistance of 1st, 2nd and 3rd generation SiCf-SiC composites [1].

In composite materials in particular, fiber-matrix interface cohesion is obviously crucial for strength and hence subject to constant attention. Recently, this resistance to loss of cohesion under irradiation has been significantly increased by interfacial pyrolytic carbon deposition (Fig. 109). The **thermal creep*** resistance is also strongly modified after irradiation, with hardening (increase in creep stress) accompanied by a decrease in ductility. The creep behavior under irradiation is more complex. A specific irradiation creep phenomenon is superposed on the conventional thermal creep and causes inverse effects, *i.e.*, under irradiation, the material deforms much more rapidly, and rupture stretching increases considerably.

Irradiation also affects the dimensional characteristics of solids.

- The volume increases under irradiation. This “swelling” has various possible causes: accumulation of punctual defects at low temperature, amorphization of the material, or agglomeration of vacancies into cavities or bubbles while mobile. In commonly used metals, the first cause is negligible, the second is ineffective, and the third produces maximum swelling as a function of temperature at 0.5 to 0.6 times the melting point, depending on the flux. In SiC, the low-temperature swelling is due to amorphization and may attain around 10%. At higher temperatures, amorphization does not occur. The swelling due to the accumulation of punctual defects decreases to approximately 0.2% when the temperature increases up to 1,000 °C (due to recombination of punctual defects) and saturates at a low dose (1 dpa SiC). At temperatures above 1,000°C, it is due to the agglomeration of the vacancies and increases with fluence and temperature, without apparent saturation as a function of fluence (Fig. 110)²⁴. This is caused by the germination and growth of very small cavities (2 nm at 625°C, 5 nm at 1,000 °C), probably favored by the presence of gas (as in the case of metals). All of these phenomena are highly sensitive to the energy spectrum of incident particles, and to the presence of gas or impurities.
- If the material is under stress during irradiation, the irradiation creep causes a deformation that increases with flux, fluence and temperature. In SiC, this phenomenon is weak and hardly dependent on temperature below 900 °C, but increases at higher temperatures.
- Anisotropic crystalline solids (*e.g.*, zirconium or graphite) deform spontaneously under irradiation in the absence of stress, stretching in one direction and shrinking in the two others (“growth”). This question could also apply to SiC, where certain fabrication methods (CVD or PVD) produce an effective texture.

Corrosion resistance can be reduced by irradiation. **Austenitic*** stainless steels are sensitive to **irradiation-induced stress corrosion** cracking, observed in the form of intergranular cracking in the primary system of water-cooled reactors. In gas-cooled reactors, new forms of corrosion will be observed in the coolant gas due to the very low chemical potential of oxygen, causing oxide destabilization, reactions between oxygen traces and carbides, and carbonization of metals by carbon monoxide.

Thermal conductivity is altered by irradiation. In SiC, it decreases under the effect of irradiation and apparently saturates below 25 dpa SiC and 1,000 °C, probably via the same punctual effects accumulation mechanism causing swelling at moderate temperature. However, the behavior of metallic carbides (ZrC, TiC) does not evolve in exactly the same manner as that of insulators such as SiC. In conductive ceramics, heat-induced electronic conduction is stronger than the phonon vibration conduction prevalent in insulators. Like all properties, thermal conductivity is extremely sensitive to chemical composition, stoichiometry and impurities, as well as microstructure (grain size).

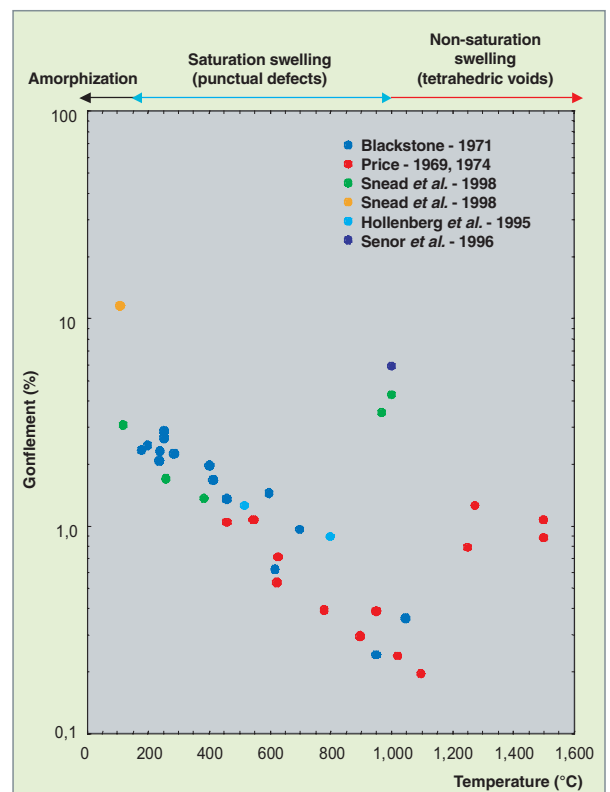

Fig. 110. Swelling of silicon carbide under irradiation, as a function of temperature [2].

24. See Fig. 116, p. 136.

Measuring the relevant properties of candidate materials, and their evolution under irradiation

In the current stage of research on GFR materials, the main objectives are to establish generic data concerning the initial thermophysical and mechanical properties of the candidate materials currently being developed, to verify their stability under high-fluence fast neutron irradiation, and to begin investigating the sensitivity of these properties to the parameters presently considered as relevant: fabrication method, purity, stoichiometry, grain size, and porosity. The experimental irradiation program includes several campaigns:

- In the PHENIX reactor, the FUTURIX and MATRIX irradiation campaigns (at high and low temperature, respectively) are in progress to achieve maximum integrated fluence prior to reactor shutdown and measure the evolution of density (swelling), microstructure, constituent phases (activation, conductivity, diffusivity), thermal expansion, calorific capacity, electrical resistivity, and high and low-temperature mechanical properties (Young and Poisson moduli, hardness, resistance and toughness);
- FUTURIX: Irradiation of refractory metals (TZM, Nb-1%Zr, Nb-1%Zr-0.06%C), massive binary ceramics fabricated by powder metallurgy (carbides: SiC, micro and nanostructured ZrC, TiC; nitrides: TiN, ZrN), and composites (CerMet: Nb-ZrC; CerCer: SiCf-SiC) at 800 to 1,000 °C, up to a fluence of 40 dpa;
- MATRIX: Irradiation of massive ceramics (SiC, ZrC, TiC) and composites (SiC-SiC) at 400 to 525°C, up to a fluence of 70 dpa. This campaign also includes various steels and superalloys for structural components outside the reactor core;
- In the OSIRIS reactor, the FURIOSO campaign launched within the scope of fusion reactor programs includes the irradiation of SiC-SiC composites at 1,000 °C.

Despite the development of experimental investigations devoted to these new materials, it is not possible to test all possible combinations, and even less so to extrapolate their properties with certainty for real service conditions, namely fluxes and durations (or cumulative doses) on a solely empirical basis. It is therefore necessary to develop models predicting their evolution under the conditions sought. For this purpose, it is essential to understand the specific physical mechanisms of microstructure alterations at the finest scales, and the mechanisms through which this microstructural evolution affects the usage properties of the materials. The example in figure 109 clearly shows the need for numerical modeling calibrated to low-dose results. These results correspond to a maximum of 80 dpa for the oldest materials (1st and 2nd generation), and only 22 dpa for 3rd generation materials. It takes years to obtain

the 200 dpa sought, multiplied by the number of materials considered, and this experiment alone does not necessarily yield all the elements required to understand the phenomenon and extrapolate the measurements to other conditions (flux, temperature, etc.).

Understanding and modeling the physical damage and evolution mechanisms under irradiation

The alteration of the usage properties of materials results directly from modifications of their chemical, crystallographic and microstructural integrity. In solids, irradiation causes three categories of phenomena, corresponding to three time scales, whose mechanisms are far more complex in ceramics, namely insulators, than in metals.

- **Transmutations*** modify the chemical identity of atoms. They produce new chemical species that alter the composition of the material. Among the species formed, helium is particularly important. Already produced in PWR internals by reaction (n, α), it is produced in far greater quantities under fast neutron flux (FBR fuel cladding, fusion reactor walls, spallation windows).
- **Nuclear collisions*** induce atomic displacements that modify the position and order of atoms, creating punctual defects, vacancies and interstitials, as well as small agglomerations of punctual defects. Under neutron irradiation, these displacements occur in cascades lasting a few picoseconds. On the other hand, in metals, the electrons only produce Frenkel pairs (one vacancy and interstitial per collision). In certain insulators, electronic excitations induce very small atomic displacements possibly involving the creation of punctual defects, and significant modifications of the electronic structure which deeply affect the mobility of defects, generally producing a very high acceleration.

Certain materials (metallic alloys or ceramics) amorphize, either directly in the cascade core or through accumulation of punctual defects. Molecular dynamics has recently shown that oxides exhibit the full range of primary irradiation damage mechanisms, from complete amorphization of the cascade core, as in Zircon ($ZrSiO_4$) [Fig. 111a], to the creation of isolated defects without amorphization, as in uranium oxide (Fig. 111b), as well as core amorphization with creation of isolated, peripheral, punctual defects. Zirconium carbide (Fig. 112), an electrical and thermal conductor, exhibits damage that is typical of metals but of uranium oxide (an insulator!). The physical causes of these differences in behavior have yet to be understood.

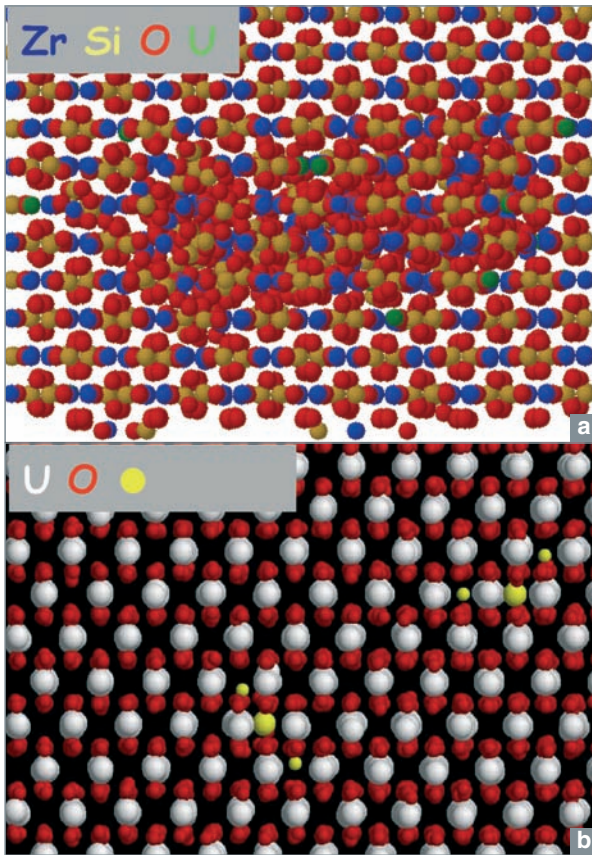

Fig. 111. Diversity of primary damage modes in ceramics under irradiation. Molecular dynamic simulation of displacement cascades in two oxides: zirconia and uranium oxide [3].

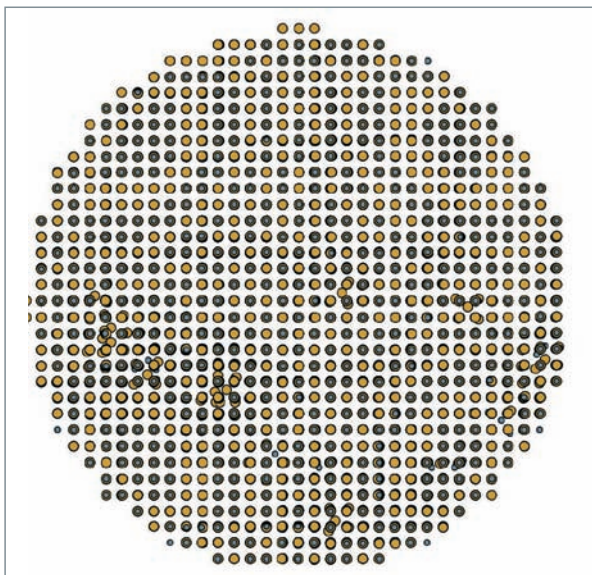

Fig. 112. Molecular dynamic simulation of a displacement cascade in zirconium carbide (Zr atoms shown in yellow, C atoms in blue).

- The microstructure of the material thus damaged undergoes a **slow evolution** throughout the duration of irradiation, **governed by diffusion** and adopting multiple forms: Agglomeration of punctual defects (interstitial loops, vacancy aggregates) and solutes until particle precipitation, cavities (large vacancy aggregates), gas bubbles, intergranular segregation, phase transformation (radiolysis, amorphization/crystallization), etc. These evolutions are either induced or simply accelerated by irradiation. The constant injection of energy prevents the system from attaining thermodynamic equilibrium. Its state and evolution are governed by the competition between ballistic atomic leaps and thermally activated leaps. The goal here is to understand and predict the kinetic paths and possible stationary states towards which the system evolves (“dynamic phase diagrams”).

Need for modeling, and coupling with experiments

Given the complexity of these phenomena and the duration or cumulative dose to be extrapolated, predictive models cannot be solely based on a phenomenological approach. To guarantee their robustness, the models must be based on physics and, as far as possible, the most reliable physics scale, which is often but not exclusively the atomic scale, all the more so since the irradiation damage production and evolution mechanisms occur precisely at that scale.

- It is first essential to understand and predict the exact mechanisms governing diffusion and its modification by irradiation. An ab initio calculation of electronic structures gives access to the elementary properties, structure, formation and migration of punctual defects. It enables the complete modeling of self-scattering [4] and crucial effects associated with impurities. In the case of ceramics, namely insulators, the considerable effects of stoichiometry²⁵, electric charge and electrical excitations can only be understood and predicted using this approach.
- Molecular dynamics is the basic tool to study ballistic damage, but its efficiency depends on the quality of the interatomic potentials used. Moreover, in the case of insulators, the ab initio approach (*i.e.*, rigorously taking into account quantum physics at the atomic scale) is indispensable in order to process electronic effects, particularly damage caused by particles other than neutrons, electrons and high-energy photons.

25. For example, in SiC, we know that the presence of free Si favors the diffusion of fuel fission products (Cs, Sr, Ba, Eu, Ag).

- The prediction of the long-term microstructural evolution kinetics mentioned above is based on models already highly developed and efficient for metals, but whose application to ceramics has only just begun: Monte Carlo kinetics techniques (rigid or relaxed networks, events, objects), homogeneous chemical kinetics (or aggregate dynamics), mean-field techniques, phase-field techniques, etc. [5].
- The understanding and modeling of mechanical behavior, particularly further to irradiation-induced microstructural alterations, is also far more developed for metals than for ceramics, but the implementation of a multiscale approach working from the atomic scale has only begun. Fracture analyses should significantly benefit from the development of this approach, as demonstrated by the discovery of the locally ductile character of the rupture of silicate glasses [6]. Discrete dislocation dynamics [7] presently constitutes the most robust interface between atomic approaches (molecular dynamics) and mesoscopic approaches (finite elements) to the mechanical behavior of crystalline solids, but it has yet to be implemented in ceramics.

Modeling work must be closely coupled with experiments. In addition to acquiring relevant data on the post-neutron-irradiation behavior of the selected materials (described above), it is essential to conduct targeted experiments to determine elementary physical properties and behaviors and to parameterize and validate the models.

Irradiation by charged particles, ions and electrons offers the possibility to reproduce and finely analyze the damage mechanisms in small, non-activated samples allowing a full range of measurements and observations, from the atomic scale and up, both *in-situ* and *ex-situ*. Electron irradiation essentially creates isolated punctual defects, whereas ion bombardment produces displacement cascades. Their comparison is indispensable for discriminating between the effects of the various types of defects. The 1 MV electron microscope of the Nuclear Materials Division is used to perform electron irradiation experiments and *in-situ* observations of the resulting microstructural evolution. Through the JANNUS project, the Nuclear Energy Division has undertaken to develop a set of multiple-beam ion accelerators with *in-situ* electron transmission microscopy (project conducted within the framework of a scientific interest group, in collaboration with CNRS-IN2P3). This platform (Fig. 113) will be used to simultaneously subject the material to ballistic damage and ion implantation simulating the production of one or two species through transmutation (namely helium and hydrogen).

We know that the synergy between these two types of damage leads to a microstructural evolution of the material different from that obtained through successive implantation and ballistic damage. In addition, the high-energy heavy ion beams of the GANIL system produce electronic excitations.

We are currently in a position to associate irradiation, modeling and observation at the same scale. Among the techniques used, the tomographic atomic probe occupies a key position (along with analytic transmission electron microscopy), as it allows atom-by-atom, 3D analyses of material volumes identical to those of calculation boxes, with a spatial resolution that has practically attained true atomic resolution²⁶. The characterization of mechanical behavior at the modeling scale is possible through *ex-situ* nano-indentation tests on accelerator-irradiated samples (affecting a width and depth in the order of 100 nm) and dedicated experiments such as MECASIC (*in-situ* tensile and creep tests on silicon carbide fibers subjected to ion beams).

The representativity of experimental irradiations and the validity of extrapolations to service conditions can only be established by coupling experiments and modeling. It is also a precious means to design and optimise the most relevant and economic in-reactor irradiation experiments and interpret their results.

26. Developed by the Physical Metallurgy Laboratory of the University of Rouen (research partner of the Nuclear Energy Division), this instrument can currently only be used with conductive materials, but a new generation of laser excitation instruments applicable to insulators is currently being developed in the same laboratory.

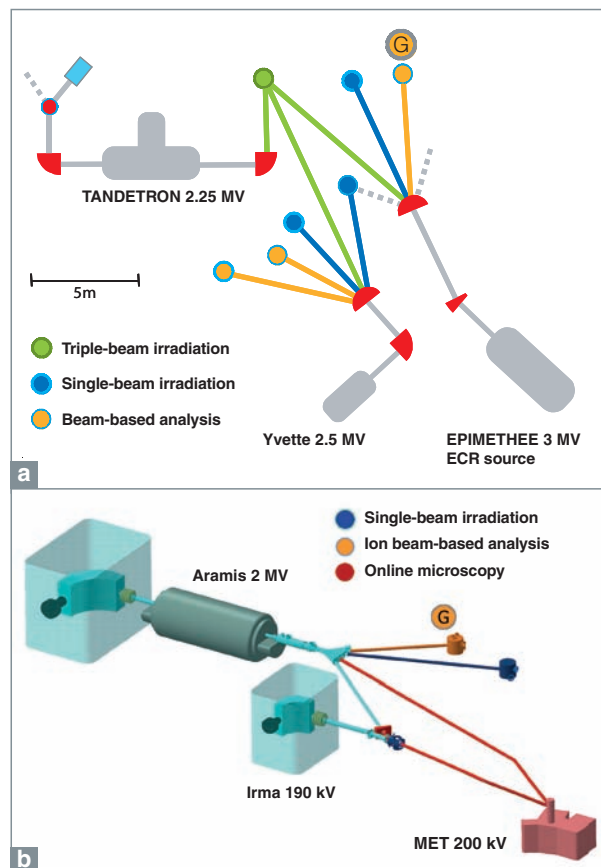

Fig. 113. Basic diagram of the JANNUS irradiation platform. Set of three linear accelerators at the Saclay site (a) and two accelerators + MET *in-situ* at the CNRS-IN2P3 Orsay site (b).

► References

- [1] R.H. JONES *et al.*, “*Promise and challenges of SiCf/SiC composites for fusion energy, applications*”, JNM, vol. CCCVII-CCCXI, p. 1057-1072 (2002).
- [2] J.-M. ESCLEINE, *Matériaux RCG-R et RCG-T. Un point sur le carbone de silicium*, NT DEC/SESC/LIAC-02-024 (2002).
- [3] D. GHALEB, L. VAN BRUTZEL, “*Molecular dynamics modeling of irradiation damage in pure and uranium-doped zircon*”, JNM, vol. CCVC, p. 167-178 (2001).
- [4] L. MARTIN-SAMOS, Y. LIMOGÉ *et al.*, “*Neutral self defects in a silica model : a first-principle study*”, PRB (2005).
- [5] P. BELLON, G. MARTIN, “*Driven alloys*”. *Solid states physics*, vol. L, p. 189-331 (1997).
- [6] L. VAN BRUTZEL, Thèse, Université Paris VI, 1999 (Rapport SRMP CEA-R-5896).
- [7] L. KUBIN *et al.*, “*Dislocation microstructures and plastic flow : a 3D simulation*”, *Solid State Phenom.*, vol. XXIII-XXIV, p. 455-472 (1992).

Michel GUTTMANN,
& Yves LIMOGÉ,
Nuclear Materials Division

Fuels for Gas-cooled Fast Reactors

Fast neutron spectrum reactors are clearly attractive reactors for all aspects of the fuel cycle. However, their production requires the development of a fuel suited to their specific requirements. The main difficulty stems from the fact that the gas coolant (helium for GFRs) is a low-density coolant. This reduces the core volume available for the fuel and its containment barriers, thereby imposing a high fissile material density or power density (from a few tens to a hundred MW/m³, *i.e.*, three to ten times less than for a liquid metal coolant). For a given burn-up and characteristic cycle time (cooling before processing), this density parameter determines the fuel cycle fissile inventory and core residency times (parameters that need to be kept within reasonable limits).

The other GFR fuel requirements are the following:

First of all, it must include 15 to 20% plutonium (with possible deviations depending on core design, *i.e.*, zoning, blankets) and approximately 2 to 5% minor actinides to cover the transition requirements for the various reactor types in the current fleet. In addition, it must allow reprocessing and refabrication of all actinides in a closed cycle via remote operation, with controlled and minimised waste generation. Its behavior within the core temperature range (400 to 850 °C under nominal operating conditions) must ensure geometric integrity and high containment of radiotoxic elements. At higher temperatures and up to approximately 1,600 °C, its behavior may be slightly degraded, but it must ensure the containment of radionuclides in the core during a loss-of-pressure accident. Finally, it must achieve **burn-up*** levels guaranteeing adequate fuel cycle economy 5 at.% **FIMA*** in the short term, 10 at.% and higher in the longer term.

The effects on the materials contained in the fuel or immediately surrounding it stem from the above-mentioned constraints. The fissile material must be as dense as possible in terms of heavy atoms. The inert materials must have low neutron capture and moderation capacities. All materials must be refractory and as thermally conductive as possible. They must all exhibit acceptable behavior under fast neutron irradiation and, in some cases, under fission product and alpha particle irradiation. Moreover, the fissile and inert materials must have minimal chemical interaction between them in order to minimise the mobility of radiotoxic elements and formation of undesirable phases, particularly at the low melting point.

Various approaches have been explored in order to satisfy these requirements

The fissile material is preferably a multiple-actinide carbide or nitride with higher density than oxides (23 and 29.5% percent higher in the case of U-Pu carbides and nitrides, respectively, with equal fabrication porosity) and therefore higher thermal conductivity (by a factor of 6.5 and 7.2, respectively). This allows for a “cold” fuel better suited to retain its fission products and therefore exerting less load on the containment barriers. Maintaining the fuel hot spot temperature at between 1,050 and 1,200 °C will keep the swelling of the fissile phase below the thermally activated regime (*i.e.*, regime where growth and coalescence of fission gas bubbles are exacerbated – see Figure 114), while retaining the vast majority of the fissile inventory within the matrix (Fig. 115).

The research themes for these candidate actinide composites (less well known than oxide composites) are the following:

- Verification of physical and thermochemical characteristics, *i.e.*, stability under different types of atmosphere (closed or non-closed system);
- Analysis of the effects of swelling, densification, retention and release of various fission/capture/decay products, including the improvement of retention properties through modification

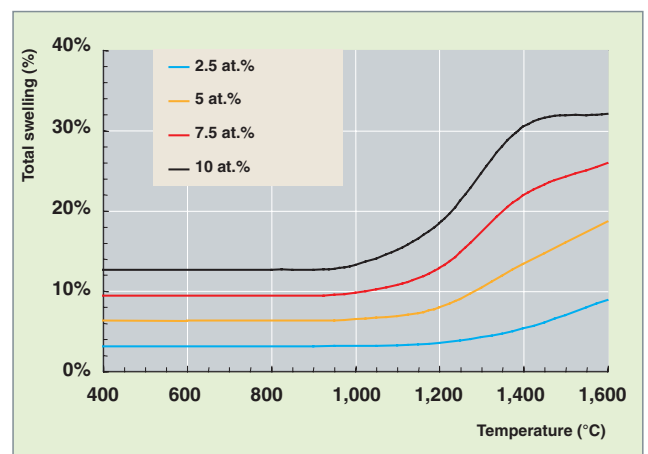

Fig. 114. Free swelling of mixed monocarbide (U, Pu)C as a function of temperature and burn-up.

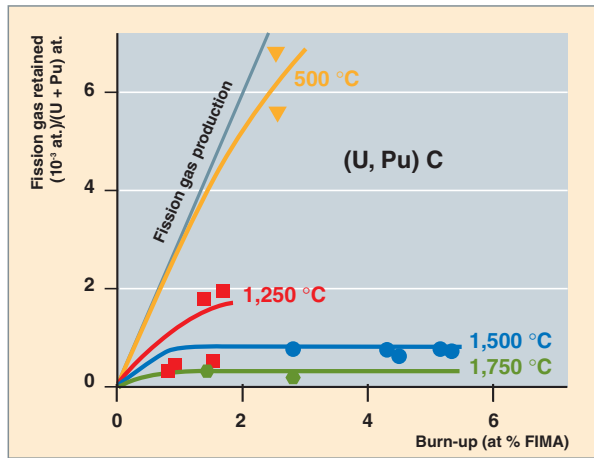

Fig. 115. Portion of fission gases retained in the mixed monocarbide, as a function of burn-up and temperature, and with respect to fission gas production.

of porosity, microstructure and doping. These effects will be evaluated according to conditions at the fuel element boundaries (atmosphere, mechanical confinement) and taking into account the presence of minor actinides in dilution.

These types of composites further impose the management of **pyrophoricity*** constraints in cycle transients and under certain reactor conditions (loss of containment, air ingress in core). Specific non-inflammation analyses are therefore also conducted.

Nitrides are theoretically slightly superior in terms of physical properties and fission product retention capacity. However, the capturing effect of the N 14 naturally present within them practically imposes an at least partial enrichment with N 15 to obtain cores with good neutronic performance.

A partial enrichment (50%) would allow for nitrogen loss and would significantly improve core performance while remaining economically acceptable. On the other hand, a higher enrichment would impose nitrogen recycling, which requires a finer assessment in technical and profitability terms. The use of natural or partially enriched nitride also raises the issue of C 14 waste management. In order to achieve a viable cost, R&D will probably also be required.

The inert materials associated with the fissile material are ceramics. Refractory metals may also be considered as an option, or more probably as a supplement. The main ceramics identified are carbides and nitrides. These ceramics are essentially covalent composites such as SiC, or non-stoichiometric, strongly interstitial, transition metal-based composites such as TiN, ZrC, TiC or ZrN, currently associated with an actinide carbide or nitride. An actinide oxide could probably be associated with another oxide such as MgO.

Silicon carbide is receiving a lot of attention. Known throughout the nuclear industry (HTRs, fusion), it exhibits acceptable behavior and low swelling at the temperatures considered and under a neutron flux of up to 80 dpa SiC, *i.e.*, practically half of the range considered (Fig. 116). It is a well-defined composite with no risk of change in stoichiometry during its core residency time. At high density (achieved by vapor phase deposition), it constitutes a good fission product barrier (with a few rare exceptions, namely palladium and silver). Moreover, it can be obtained using various methods (extrusion-sintering, reactive sintering, vapor phase deposition, or liquid polymer precursor decomposition).

Titanium carbide and nitride seem to have good potential. They are very good heat conductors, with expansion coefficients very close to those of actinide composites. However, a significant amount of complementary data still needs to be acquired (fabrication techniques, thermal stability, irradiation behavior, etc.).

All of these ceramics are subject to verification of their physical characteristics and irradiation behavior. Heavy ion irradiation experiments are in progress at the GANIL laboratory to simulate the damage induced by fission products (Fig. 117) and assess its effects (Fig. 118). A fast neutron irradiation program with a heating system to reconstitute representative temperatures will be conducted in the PHENIX reactor (Fig. 119). This program will also address the effects of impurities, stoichiometry, microstructure and shaping (monoliths, fibers, thin layers, etc.) in connection with fabrication methods, diffusion

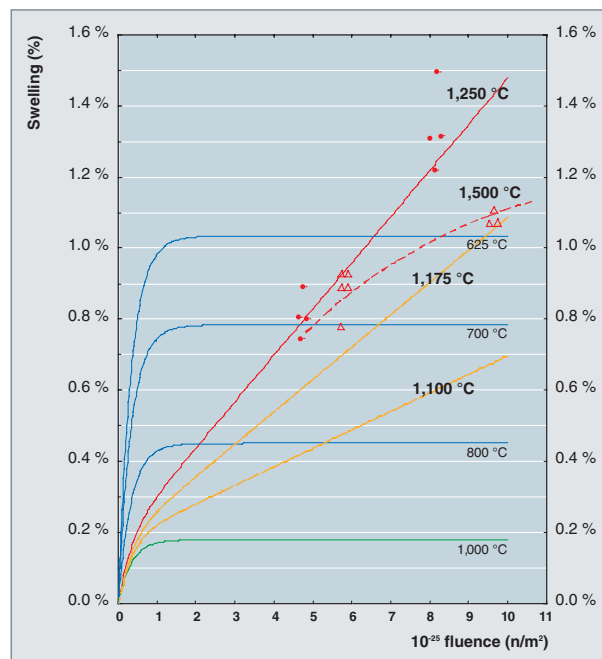

Fig. 116. Swelling of silicon carbide as a function of neutron fluence and irradiation temperature.

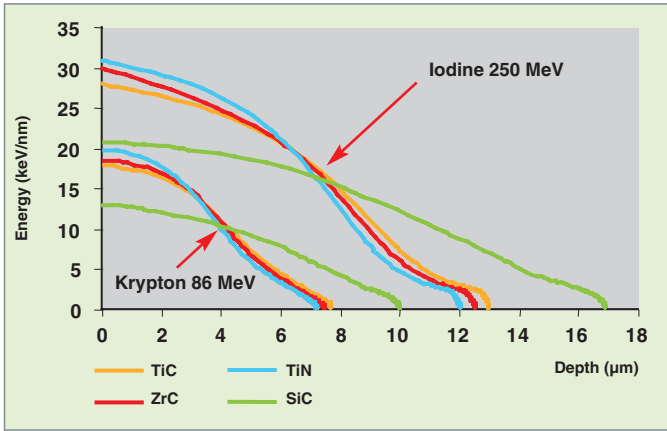

Fig. 117. Irradiation results at GANIL (Kr 86, 86 MeV, $5 \cdot 10^{15}$ ions/cm²) and Vivitron (I 127, 250 MeV, $1 \cdot 10^{15}$ ions/cm²): energy dissipation in ceramics of interest for GCR fuel.

rates and mechanisms of main fission products, and chemical behavior (reaction products and kinetics) in the presence of the fissile composites considered.

Refractory metals W, Mo and Nb are neutron absorbers and can only be considered in small quantities or depleted of absorbent isotopes. This is also the case, to a lesser extent, with certain semi-refractory metals such as Zr or Ti, which in addition do not provide a sufficient temperature margin in accident situations. However, given their specific characteristics (particularly their ductility potential), part of the R&D themes on ceramics will be applied to these metals and supplemented with metal/ceramic interface studies.

The fuels studied on this basis do not all allow the same cores. Particle fuels might be difficult to use in a fast spectrum. Their multilayer coating ensures the containment of fission products very close to the fissile nuclei where they are emitted. But even if the ratio of layer volume to nucleus volume is reduced to the low technological limit, this type of fuel can only be considered in large cores with low neutron leakage and low power densities. This is due to the low space-filling capacity of the spheres. Moreover, certain materials (**pyrolytic carbons***, in particular) must be replaced with new materials better adapted to the constraints imposed by fast neutrons. R&D is therefore aimed

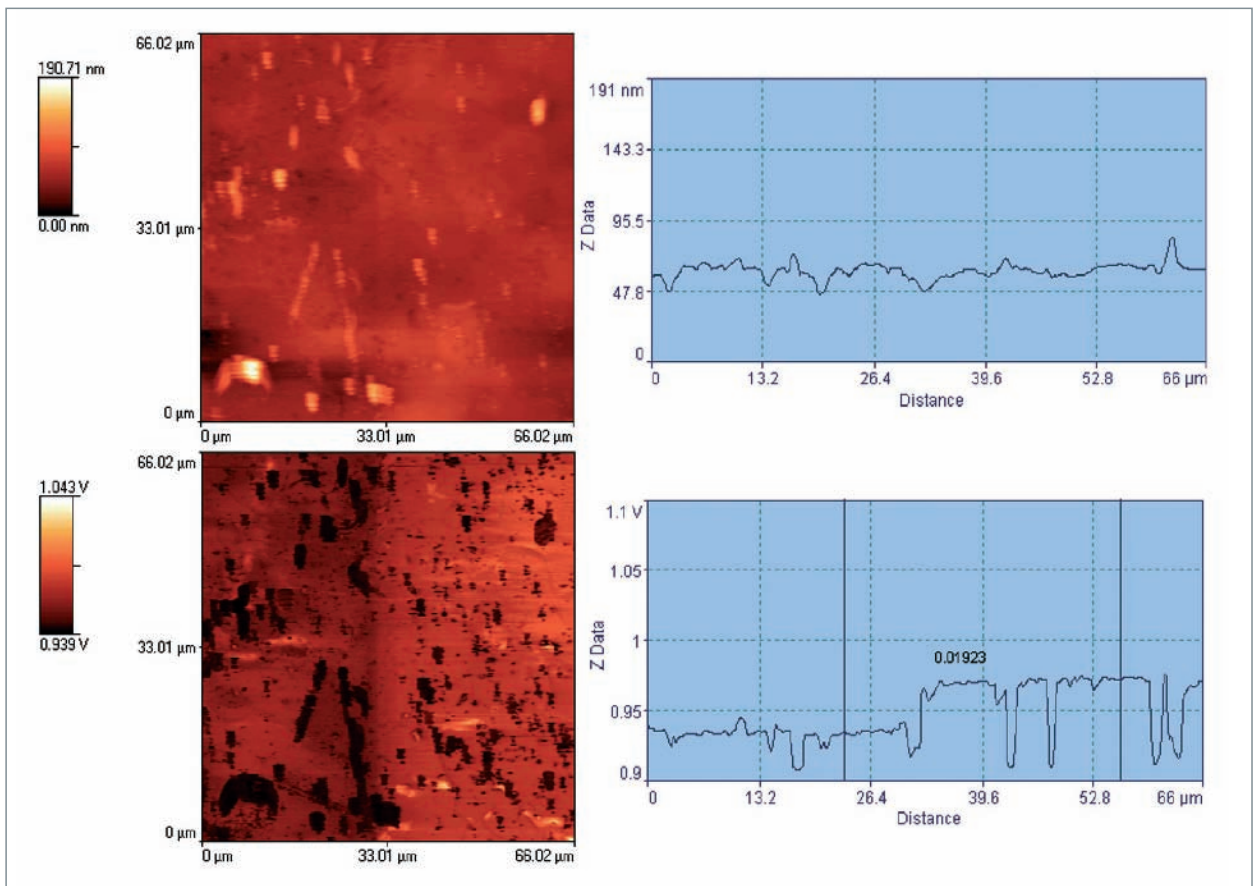

Fig. 118. Examination of irradiated ceramics with a Scanning Thermal Microscope. The thermoresistive probe is used to measure the topography (top) and surface thermal conductivity contrast (bottom). TiC irradiated with Kr ions at 86 MeV with a fluence of $5 \cdot 10^{15}$ ions.cm⁻² and an ion implantation depth of 8 µm. Only the left half of the sample has been irradiated.

The topography is not modified by the irradiation (no significant swelling). On the other hand, the thermal conductivity is modified (which is not the case with experiments on SiC). (Collaboration with the CETHIL laboratory, INSA Lyons.)

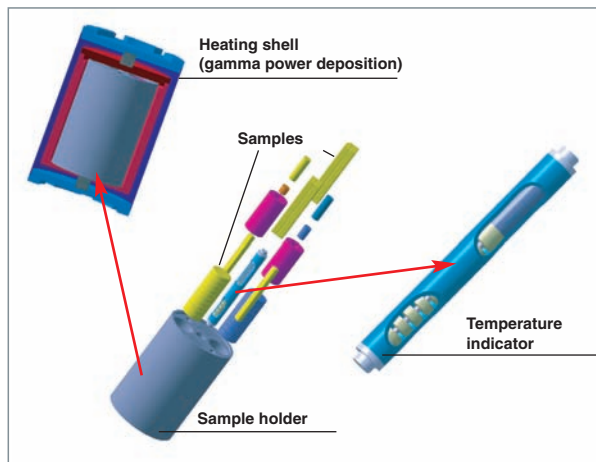

Fig. 119. Fast neutron irradiation of high-temperature samples in the PHENIX reactor.

at developing substitution materials with graphitic behavior, densification and irradiation creep kinetics adapted to fast fluence, and optimised geometries.

On the contrary, pellet fuels (clad pellets) consist of a pure solid solution of actinide composites, therefore allowing for denser and smaller cores. In this case, the main R&D theme is the development of the cladding, which must be slender, refractory (without using large quantities of metals) and hermetic under all conditions (good mechanical resistance and maximum ductility). Solutions based on fiber/ceramic composites with appropriate metallic coatings are being studied.

Research on dispersed fuels with high actinide density (as compared to particle density) is also in progress. Such fuels could allow for cores more efficient than those using particle fuels, and with high fission product retention. Current studies lead to the development of long actinide aggregates with high space-filling capacities. These aggregates would have a regular shape and spatial distribution to avoid excess damage of their isolating matrix due to fission product recoil. Maintaining the mechanical integrity of this matrix is an essential condition to ensure effective containment of radiotoxic products. A complex matrix is required in order to ensure the various functions:

- Hermeticity;
- Accommodation of fission gases and actinide composite expansion;
- Mechanical resistance and slight deformation capacity;
- Chemical barrier (accommodation of irradiation damage).

Figure 120 shows the various concepts and their core design application domains. All of these concepts allow the incorporation of minor actinides in the above-mentioned proportions without excessive design constraints. Specific limitations need to be assessed as we approach an irradiation rate of 5% FIMA, with the pellet fuel probably exhibiting better behavior at higher levels. However, this incorporation has a significant impact on fuel cycle processes and requires robust, remote-operated fuel fabrication processes in strong synergy with fuel reprocessing (physical form or type of co-conversion products).

Various methods are currently being studied to achieve fissile aggregates (spherical kernels, long aggregates or pellets): solid methods (powder metallurgy, dry agglomeration), semi-solid methods (binder additive, extrusion, sintering), sol-gel liquid solutions, capture on carbonated ion-exchange media, and calcination. The inert parts can also be achieved using various methods: solid, semi-solid, liquid (using pyrolyzed liquid polymer precursors) or gaseous (via deposition or impregnation with gas-phase precursors). Figure 121 shows a mixed U-Pu nitride-based high-density dispersed fuel in a prefabricated, silicon carbide honeycomb matrix.

GFR fuel reprocessing has also been studied. The first step of the process consists of destructuring the fuel elements so as to enable the solvent to access the fuel material. Various destructuring techniques are considered: mechanical technique, pulsed currents, acoustic waves or **pyrochemistry***. After destructuring, the actinides and inert materials can be separated using processes that exploit their physical or chemical characteristics. The dissolution of the actinide composite in various media (aqueous, salt or molten metal solutions) is currently considered.

The actinide **separation*** method most considered with a view to actinide recycling consists of a grouped separation in an aqueous solution by solvent extraction (**GANEX***). Associated with the co-conversion by calcination of a composite under

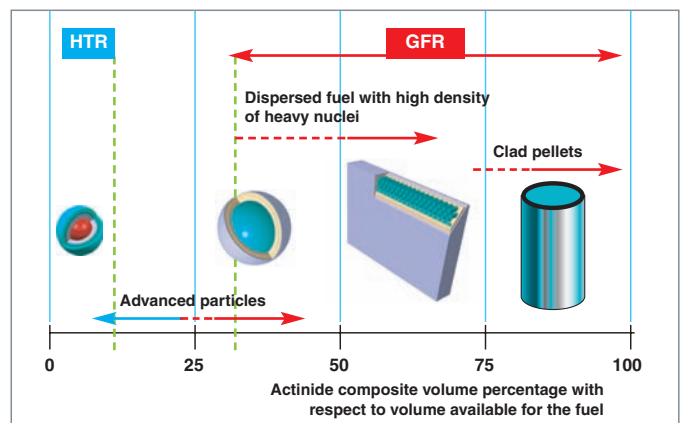

Fig. 120. Candidate concepts for GFR fuel.

controlled atmosphere, this method has the potential to produce actinides in the chemical form desired, without separation of species. It should therefore make a decisive contribution to the non-proliferating character of the fuel cycle. Other important objectives include the achievement of a high actinide recovery rate (99.9%), processing of residues and effluents, and conditioning of final waste.

R&D will need to privilege the most coherent fabrication processes by focusing on the fuels progressively identified as most promising through a suitable irradiation program. For example, these processes may include directly extracting all actinides from the dissolution medium by fixing them on a support material suited for the direct production of fissile materials usable in the next fuel load. The CEA has recently developed a method to fix actinides on ion-exchange resin beads (Figure 122), possibly allowing conditioning in the form of spherical kernels, directly from the dissolution medium. To date, testing has been conducted with polycarboxylate resin beads in an aqueous medium, using neodymium to simulate the actinides.

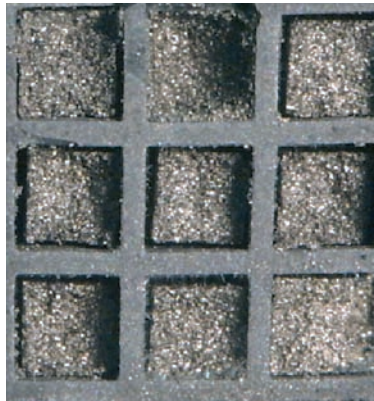

Fig. 121. High-density fuel achieved by incorporating a mixed U-Pu nitride in an extruded and sintered hollow silicon carbide structure.

Philippe MARTIN,
Fuel Research Department

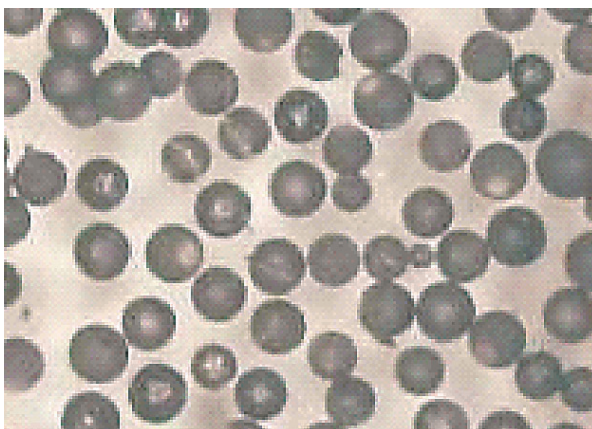

Fig. 122. Neodymium oxycarbide kernels achieved by fixation on an ion-exchange resin in an aqueous solution.

The proposed Experimental Technology Development Reactor (ETDR)

A precursor for Gas-cooled Fast Reactors

In addition to its contribution to the development of modular High-Temperature Reactor (HTR) technology, due to come on-line in 2015, the CEA has also proposed a gas-cooled system using fast neutrons and an integrated fuel cycle (the Generation IV Gas-cooled Fast Reactor - GFR). The development of this system will require innovation in the technologies relating to the fuel, materials, safety systems and cycle processes, and will be based on internationally shared experimental resources forming part of the Generation IV R&D plan (Fig. 123).

The aim of this plan is the construction of a prototype 600 MWth GFR that will be used to generate electricity and gain experience in the operation of the reactor and its associated integrated fuel cycle in order to identify and measure the parameters essential to the deployment of the technology.

An essential stage in the development of this prototype is the construction of an experimental reactor for the evaluation and development of the underlying technologies. This will be the Experimental Technology Development Reactor (ETDR).

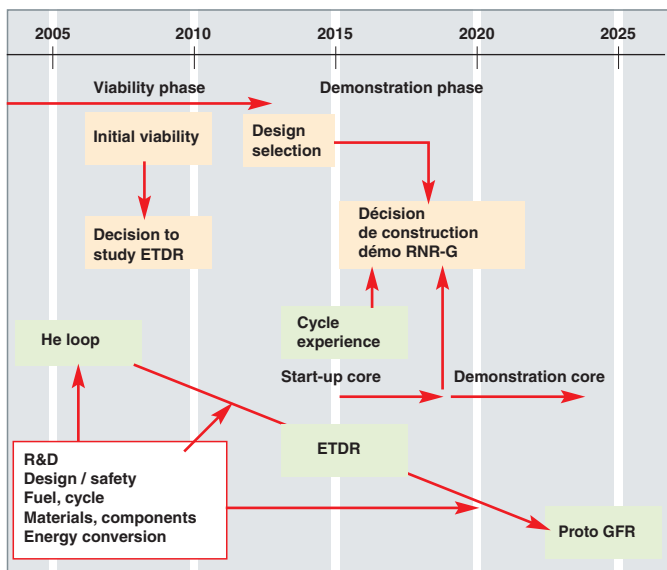

Fig. 123. The place of the ETDR in the GFR development plan.

The purpose of the ETDR

The overall purpose of this experimental reactor is firstly to demonstrate the viability of the GFR and its fuel cycle with a view to deployment of the technology in the long term, and secondly to carry out the demonstrations needed to qualify the decisions made with regard to the prototype.

The ETDR must therefore fulfill the qualification requirements for the behavior of the various systems (fuel, absorbent, reflector, etc.) under representative neutron flux conditions, together with the requirements for the operation of the entire core, the surveillance, regulation and protection systems, and the safety options for the technology and fuel handling.

In this regard, it is different from the experimental Material Testing Reactors (MTR) such as the **Jules Horowitz reactor*** (JHR) the purpose of which is the irradiation of samples of fuel and structural materials. The development of GFR technology will require irradiation tests in MTR reactors such as the Osiris, HFR and JHR, or in experimental fast neutron reactors such as Phenix, Joyo or Monju.

The ETDR covers all the requirements between this sample irradiation phase and the construction of an industrial prototype, with the degree of flexibility needed to enable the study of the range of core and fuel assembly designs that may be adopted for the technology and its prototype. The inclusion of local spectrum moderation systems also makes it possible to carry out irradiation experiments on fuels for all the various designs of gas-cooled reactors using a strong neutron flux. This will considerably reduce the time needed by comparison with existing gas-cooled reactors.

The main design options

The ETDR will have a power of around 50 MW and will not generate electricity. It will be cooled by helium under a pressure of around 7 MPa in an isobaric loop fitted with blowers. The outlet temperature may reach 850 °C and the primary coolant system will be cooled by means of a heat exchanger (Fig. 124).

Three options for the design of the first core have been considered.

The first is based on HTR core technology operating with a thermal spectrum. This will be developed to achieve a specific power of 20 MW/m³ (over three times the normal specific power of an HTR). This will provide neutrons to a central area in which the new technology will be tested. This area will operate with a fast spectrum and a specific power of more than 100 MW/m³.

The interfacing between the two zones has proved difficult, and this has led to a reduction in the useful experimental volume. Moreover, it is the content of the experimental zone that determines its neutron spectrum and this has required the use of high and non-representative enrichment. Finally, the development of this core design into a homogeneous fast spectrum design, as required for the qualification of the core operation, cannot be carried out progressively.

The second option is based on an extrapolation of HTR technology, with a very significant reduction in the relative volume of graphite in the fuel assembly. This results in a quasi-fast spectrum capable of providing the target irradiation performance in the central experimental zone from which the graphite has been removed. This second option therefore corresponds to a relatively homogeneous core that is, however, heterogeneous with regard to the fuel assembly technologies. The disadvantage of such a solution is the requirement for a highly-enriched particulate fuel. The behavior of such a fuel under irradiation by a fast flux has yet to be qualified. A considerable R&D effort is required in order to provide a solid foundation for this option, and this needs to be started without further delay. This R&D effort will also only remain “useful” for as long as the particulate fuel design option remains valid for the GFR.

The third option is based on the use of fuel pins (clad fuel elements) using proven technology from liquid sodium cooled fast reactors. This option provides for a perfectly homogeneous core from the point of view of the fast spectrum which is also capable of accepting assemblies using technologies gradually approaching the technologies to be qualified. One disadvantage is that the temperature will have to be limited to a maximum value compatible with the characteristics of the steel cladding.

This third option has been selected as it provides the best guarantees of viability in the short term and a high degree of flexibility in progressing to a homogeneous core representative of the technologies to be tested (see Table below).

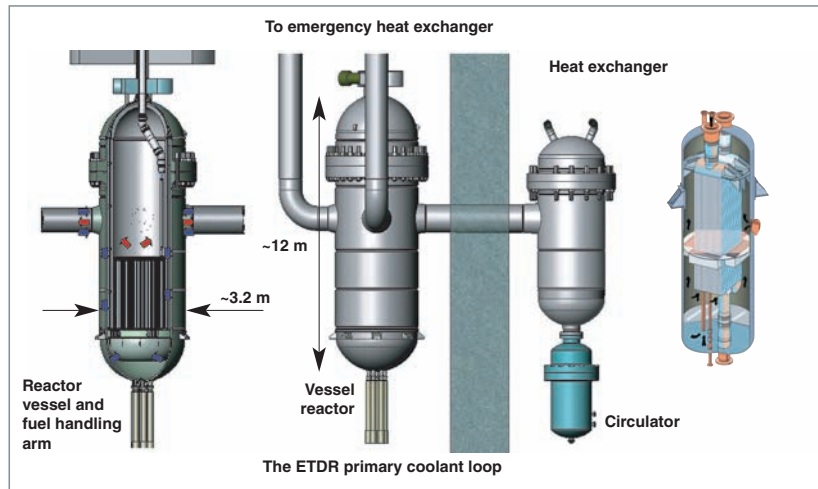

Fig. 124. View of the ETDR.

The size of the core must take account of the fact that a small core increases the neutron leakage. In order to maintain the reactivity, it is necessary to increase the fissile element content (plutonium in this case). However, to a first order approximation and all other factors being equal, the specific power is proportional to the product of the fissile element content and the flux. The aim is to increase the specific power while maintaining a flux level representative of the prototype. The result of this optimisation is given in Table below.

The main characteristics of the GFR and ETDR		
	GFR reference	ETDR demonstration
Power Dty (MW/m ³)	103	210
Core vol. (L)	5,800	238
% fissile /matrix	25 / 10	15 / 35
% gas / structure	55 / 10	40 / 10
Delta P core (bar)	0.4	0.7
Management (EFPD)	3 x 441	6 x 180
Pu / (U + Pu) %	16	30
φ Max (n.cm ⁻² .s ⁻¹)	1.6 10 ¹⁵	1.8 10 ¹⁵
% du φ > 0,1 MeV	49	60
Doppler (pcm)	-1,136	-473
Depressurisation He (pcm)	356	0

Fuel qualification and changes to the core configuration

The ETDR will therefore first go critical with a core consisting essentially of fuel pins based on well-understood technology. This core is referred to as the start-up core. It will include a number of experimental uranium-plutonium precursor assemblies, which may be based on a range of technologies. The homogeneity of the spectrum provides for a high degree of flexibility enabling the core to be used to progressively qualify an increasing number of advanced technology test assem-

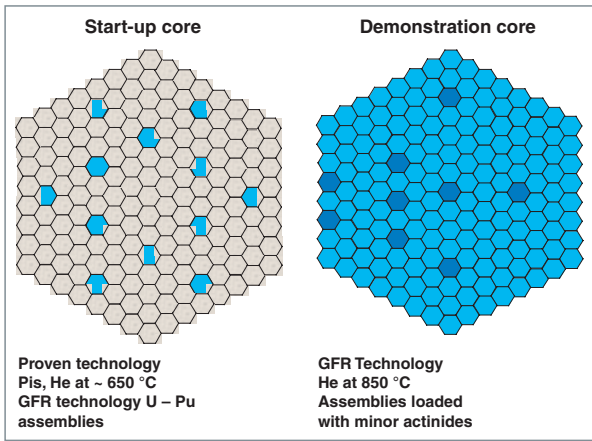

Fig. 125. Planned development of the ETDR core.

blies, provided that these remain geometrically compatible with the core

In the second phase, the core will consist of assemblies based on the technology finally chosen for the GFR. This will be the demonstration core. The outlet temperature may reach as high as 850 °C and it will be possible to obtain qualification data relating to the neutronic behavior of the core and on the operation of the reactor using this homogeneous core. Fuel assemblies containing minor actinides will be progressively introduced with the aim of representing the assemblies to be used in a GFR in which all the actinides are recycled. This process is illustrated in Figure 125.

The contribution to demonstrations relating to the fuel cycle

Eventually, both the upstream (fuel supply) and downstream (reprocessing and remanufacture of the fuel including the recycling of the actinides) aspects of the fuel cycle will form an inte-

gral part of the GFR fuel cycle process qualification procedure using a full-size core.

The fuel manufacturing technology will initially be validated using uranium-plutonium assemblies that can be manufactured in a **glove-box***. Later tests will be carried out using assemblies containing minor actinides which will have to be manufactured by remote control in shielded cells.

Figure 126 gives a schedule for the requirements for the various types of fuel for use in the ETDR and prototype industrial reactor. The manufacturing tools will be developed logically with the aim of managing the transition from R&D plants to industrial plants as smoothly as possible.

An experiment involving a complete cycle using around 1 kg of actinides (a fraction of an ETDR fuel assembly) will be key stage in the technology development program. The reprocessing and subsequent remanufacture may enable a complete closed cycle experiment to be carried out using the ETDR. In addition to demonstrating a full understanding of the processes required, one objective will be the study of the behavior of such a fuel assembly in the core with particular emphasis on the reuse of all the minor actinides in the fuel. The presence of a residual proportion of impurities and fission products after recycling will also be studied.

Safety options

One of the main purposes of the industrial prototype will be the creation and validation of the safety documentation for the technology. The evacuation of the residual power will require dedicated systems. This safety documentation will include the expected safety objectives for the technology, together with the requirements and demands imposed by the safety authorities.

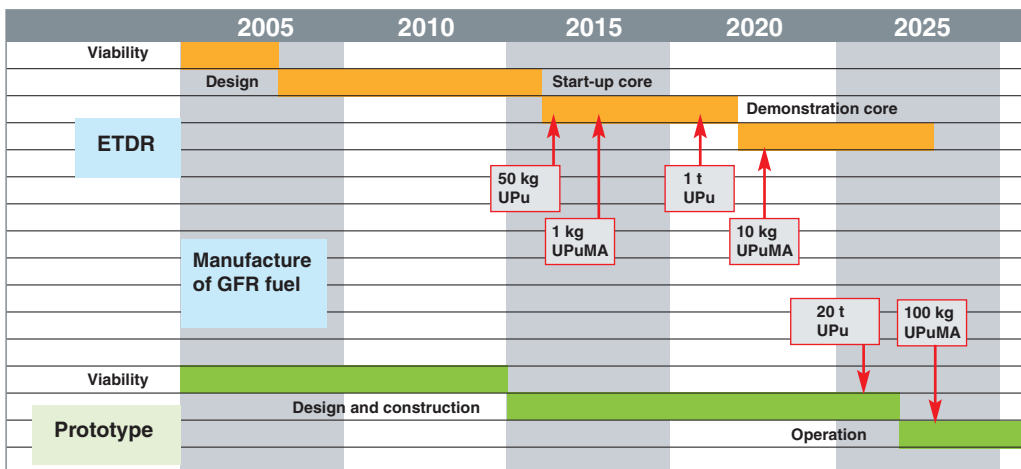

Fig. 126. The GFR fuel manufacturing requirements.

Some aspects of the safety options for the ETDR will not be transferable to the standard reactor using the technology. For example, the proportion of radioactive elements may be greater than in the prototype. However, these options will constitute an important step in the definition and validation of the safety options for a gas-cooled fast reactor, and any requirements imposed by the safety authorities will form a basis for any subsequent reactors in the future.

The operation of the core and qualification of software

It is hoped that the following questions will be determined experimentally using the ETDR:

- The interactions between the neutronic, thermal and heat-related gas flow parameters. Neutron feedback resulting from increases in the inlet temperature, core heating or power. These phenomena involve all aspects of the physics of the reactor, including support and mechanical balance of the core, support for the fuel rod mechanisms, heat flows between the structure and the gas, thermal parameters of the fuel, Doppler effect and thermal expansion of the fuel elements. These physical characteristics determine the natural behavior of the core and are therefore important parameters in the safety analysis;
- The residual power in the core and the conditions under which it can be evacuated in addition to the tests that will be carried out using an inactive loop. The management of the beginning of loss of cooling transients will be a key point in relation to the safety of cores with low thermal inertia.

The parameters given above will all be calculated in advance of the tests using models that have been qualified with significant uncertainty bands on either a critical model, an experimental quasi-zero power reactor such as Masurca, or during inactive loop tests. The aim of the ETDR experiments will be to reduce the uncertainty bands, to qualify all the studies and coupled simulations, and to consolidate the qualification of the software design tools.

Surveillance and protection systems

The design of the GFR will require different surveillance, regulation and core protection systems from those used in the HTR. These will include high-speed measurements of heating and power, and the monitoring and detection of any breaches in the primary barrier.

The ETDR will provide a tool for the qualification of this equipment under operational conditions of response times, temperatures and neutron flux. The equipment itself will need to be developed before the technology can be deployed.

An evolutionary process

The fast gas-cooled reactor represents a radical departure from earlier gas-cooled thermal reactors, particularly in terms of the fuel and safety systems. An experimental precursor reactor is therefore essential in order to develop and of qualify the underlying technologies. The ETDR fulfils this requirement while offering the flexibility needed to develop existing technologies, evaluate a range of innovative technologies, and adapt to their development and qualification to the point where they can be used in an industrial prototype.

Jean-Louis CARBONNIER,

Nuclear Development and Innovation Directorate

GFR fuel cycle: Innovative processing methods

New challenges for fuel design

The long-lived radioactive waste management and proliferation-resistance objectives defined for the GFR impose various requirements on the associated fuel cycle.

The number of heavy atoms per volume unit available for the fuel and containment barrier must be as high as possible in order to achieve an economically competitive reactor core. **Burn-up*** fractions of 10 to 15 at.% must be achieved to ensure fuel cycle economy. The fuel must contain 15 to 25% plutonium, approximately 80% uranium and 2 to 5% minor actinides to ensure Pu power generation and **isogeneration***,

and long-lived minor actinide transmutation. Radiotoxic elements must be retained as near as possible to the production source to ensure better containment radionuclides. The fuel cycle must be closed by privileging global processing and recycling of actinides, so as to facilitate final waste management and minimise fuel cycle **proliferation*** risks.

These requirements and the various functions to be ensured by the fuel and its cycle have led to the definition of innovative fuel concepts that differ significantly from the industrial fuel concept currently used in PWRs, and to the adoption of a closed fuel cycle completely recycling all actinides [1], [2], as opposed to the current cycle where only separate uranium and plutonium fluxes are recovered.

As discussed in section devoted to the GFR fuel²⁷, the choices of fuel elements are currently still open while awaiting the results of the assessments of possible fissile composite / inert matrix couples, *i.e.*, (U, Pu)C/SiC, (U, Pu)C/ZrC, (U, Pu)C/TiC, (U, Pu)N/ZrN et (U, Pu)N/TiN, etc. Two fuel assembly concepts (see Fig. 127) are currently subject to mechanical and thermochemical analyses: Flat pellets arranged in a regular network within a plate-type matrix, and longer pellets stacked in a refractory cylindrical cladding. These choices regarding fuel assembly type, composition, constitution and geometry will determine the processing methods to be implemented downstream of the fuel cycle.

Processing methods

The objective to completely recycle 99.9% of spent fuel actinides at a lesser cost requires the development of processing methods that are efficient and compact (high recovery efficiency, minimum number of operations, minimum equipment size), compatible with operations downstream of the fuel cycle (online industrialization of processing and refabrication operations), and able to manage their own waste. Based on these considerations and the conceptual designs of the fuels to be processed, a general processing scheme has been established (Fig. 128) and around thirty hydrometallurgical and **pyrochemical*** processes have been identified for the various operations to be implemented, keeping in mind that one of the main difficulties, at least for the initial fuel cycle concept, concerns the separation of the inert matrix and fissile composite upstream of the actinide separation process.

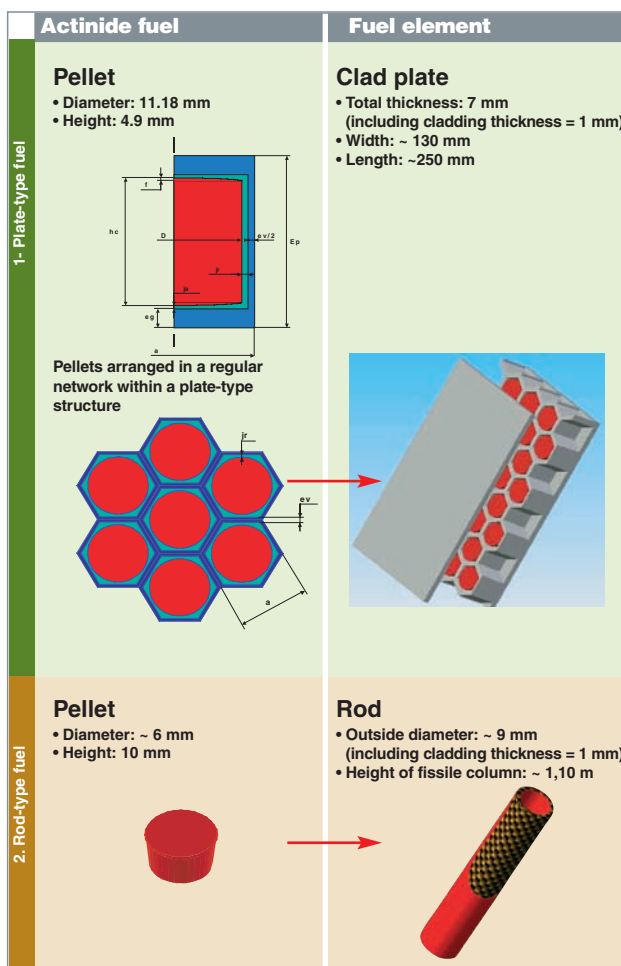

Fig. 127. Illustration of the two GFR fuel concepts currently being evaluated.

27. See *supra*, p. 135-139.

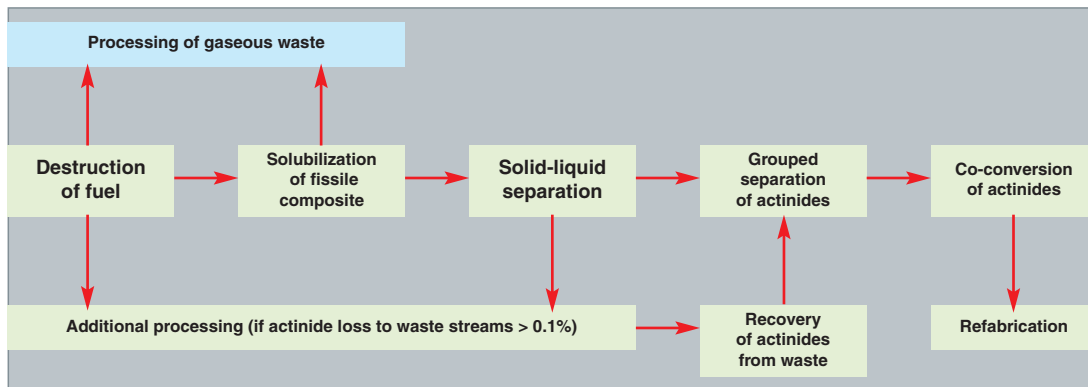

Fig. 128. General processing scheme for the GFR fuel.

While awaiting the selection of a reference fuel, laboratory studies are essentially conducted on an exploratory basis, to either verify the absence of redhibitory aspects (at least for processes with strong potential, eg, destructuring of fuel elements by pulsed currents), demonstrate the scientific feasibility of key processing steps (e.g., grouped separation of actinides by liquid-liquid extraction and co-conversion by oxalic or sol-gel processes), or assess the potential of innovative recycling processes for GFR actinides (e.g., pyrochemical processes).

The section below covers the R&D carried out in the **ATA-LANTE*** facility as regards high-potential or innovative processes.

Hydrometallurgical processes

Destructuring of fuel elements by pulsed currents

Solids exposed to energies of a few kilojoules produced by high voltage pulses of approximately 200 to 500 kV and discharge currents of 10 to 20 kA are locally subject to energy density transfers after a few microseconds (10 to 100 J/cm). This input of energy causes local temperature increases of up to 10,000°K and pressures of approximately 10^{10} Pa that instantaneously fragment the solid, reducing it to fine or moderately fine debris.

The first tests concerning the destructuring of GFR fuel materials by pulsed currents have been recently conducted using an SiC honeycomb plate structure filled with SiC simulating the fissile composite (concept 1). Figure 129 shows the specimen before and after the application of pulsed currents. The destructuring results observed are encouraging and suggest the possibility of using this process to access the fissile composite of plate-type fuels without having to dissolve the full fissile-inert matrix composite. This destructuring analysis is to be pursued using more representative specimens, e.g., a closed plate fuel or dispersed coated particles (HTGR type fuel) in an inert matrix binder.

Grouped extraction of actinides

The grouped actinide extraction process (Fig. 130) was conceived based on two principles: operating experience feedback from the 1960's and 70's concerning the nitric dissolution of actinide carbides, and suitability of liquid-liquid extraction technology for nuclear applications. This process comprises a preliminary uranium separation step, followed by the grouped extraction of transuranians and residual uranium from the raffinate [3]. Two possible methods to achieve this separation step are currently being examined:

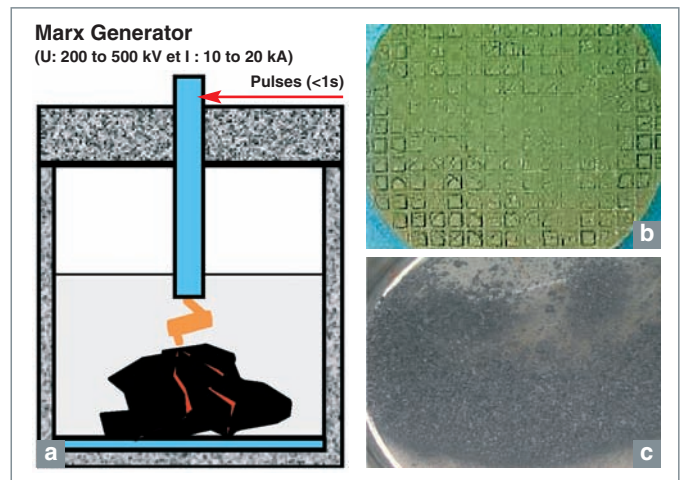

Fig. 129. Basic diagram of the pulsed-current process (a), and image of an SiC honeycomb structure filled with SiC (plate-type fuel), prior to application of pulsed currents (b) and after 30 pulses (c).

1. Adaptation of the existing advanced process for the separation of minor actinides

The DIAMEX-SANEX process used to separate the americium and curium in the raffinate from a first extraction cycle can be modified to ensure the grouped extraction of actinides U-Pu-Np-Am-Cm. Laboratory studies are in progress to acquire data on the separation of U, Pu and Np actinides by

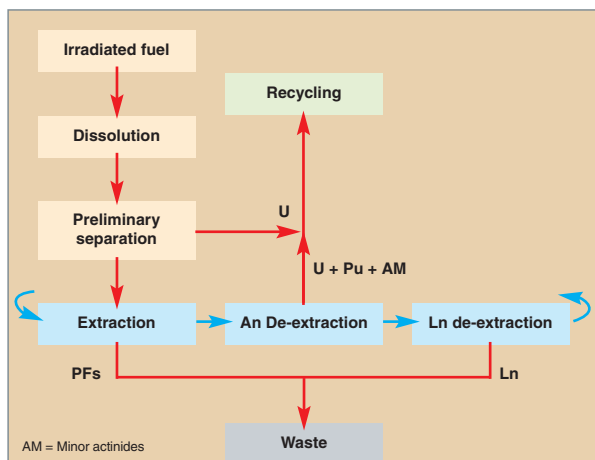

Fig. 130. Basic diagram of the grouped actinide extraction process (GANEX).

nitric acid and diamide extractants, alone and in a mixture with dialkylphosphoric acid. These data are required in order to adapt the DIAMEX-SANEX process to the grouped separation of actinides. Moreover, the need to have two actinide rings with uranium-actinide ratios of 0.78 (inner ring) and 0.81 (outer ring) in the GFR core at the beginning of the core operation imposes a partial pre-separation of the uranium in the first step of the cycle so as to then adjust the uranium fluxes to the proper content values during the subsequent co-conversion or fabrication steps. For this purpose, a monoamide process is currently being defined. Based on current knowledge, it appears that the grouped separation of actinides will be performed in two cycles as shown in Figure 132 below. A scientific demonstration of this process on a real solution in the ATALANTE facility is planned for 2008.

2. Development of new extractant molecules

The search for extractant molecules with higher selectivity, load capacity and robustness, and the synthesis of molecules able to contain or support different coordination sites (bitopic extractants) for the co-extraction of actinides with different oxidation levels (e.g., An(IV)-An(III) and An(VI)-An(III) mixtures) have been initiated on the basis of the development of BisTriazinesPyridines (BTP) molecules. These molecules have been tested within the scope of the scientific demonstration of advances processes for the separation of americium and curium from high-activity effluents of the PUREX cycle. They can extract the actinides from a high-acidity effluent and are selective with respect to **lanthanides***. They have an excellent actinide/lanthanide separation capacity. The tests conducted on the first molecules have shown a significant sensitivity to **radiolysis***. In order to increase radiolysis resistance, two new BTP molecules have been synthesized by grafting triazine motifs in alpha position: Bis(cyclohexyl-tetramethyl)-BTP and Bis(benzo-cyclohexyl-tetramethyl)-BTP. A representation of these BTP molecules is provided in Figure 131. With these molecules, actinide extraction and separation capacities

remain excellent and radiolysis resistance is significantly improved. On the other hand, a degradation of extraction and de-extraction kinetics has been observed. Investigations are being pursued to eliminate this problem and develop more efficient molecules.

Co-conversion of actinides

The co-conversion of actinides is a key step between fuel processing and refabrication operations. Two co-conversion methods are currently being developed in order to produce a solid actinide compound with the preform required, at the front end of the fabrication chain: sol-gel internal gelation process (for the formation of spherical actinide nuclei) and oxalic co-precipitation process (for the formation of a solid actinide solution).

1. Sol-gel process

External gelation, particularly using the NUKEM technology, is often privileged for the industrial fabrication of uranium nuclei. However, its adaptation to the co-management of actinides poses two difficulties: significant production of concentrated ammoniacal effluents, and complex adjustment of gelation conditions for homogeneous, simultaneous and global hydrolysis of all actinides with various oxidation levels.

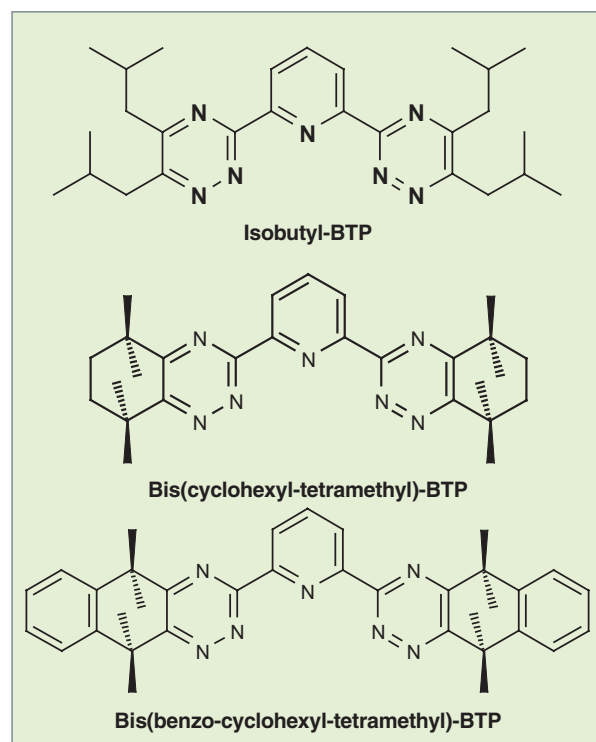

Fig. 131. Architecture of BTP molecules tested for the separation of actinides in a single cycle.

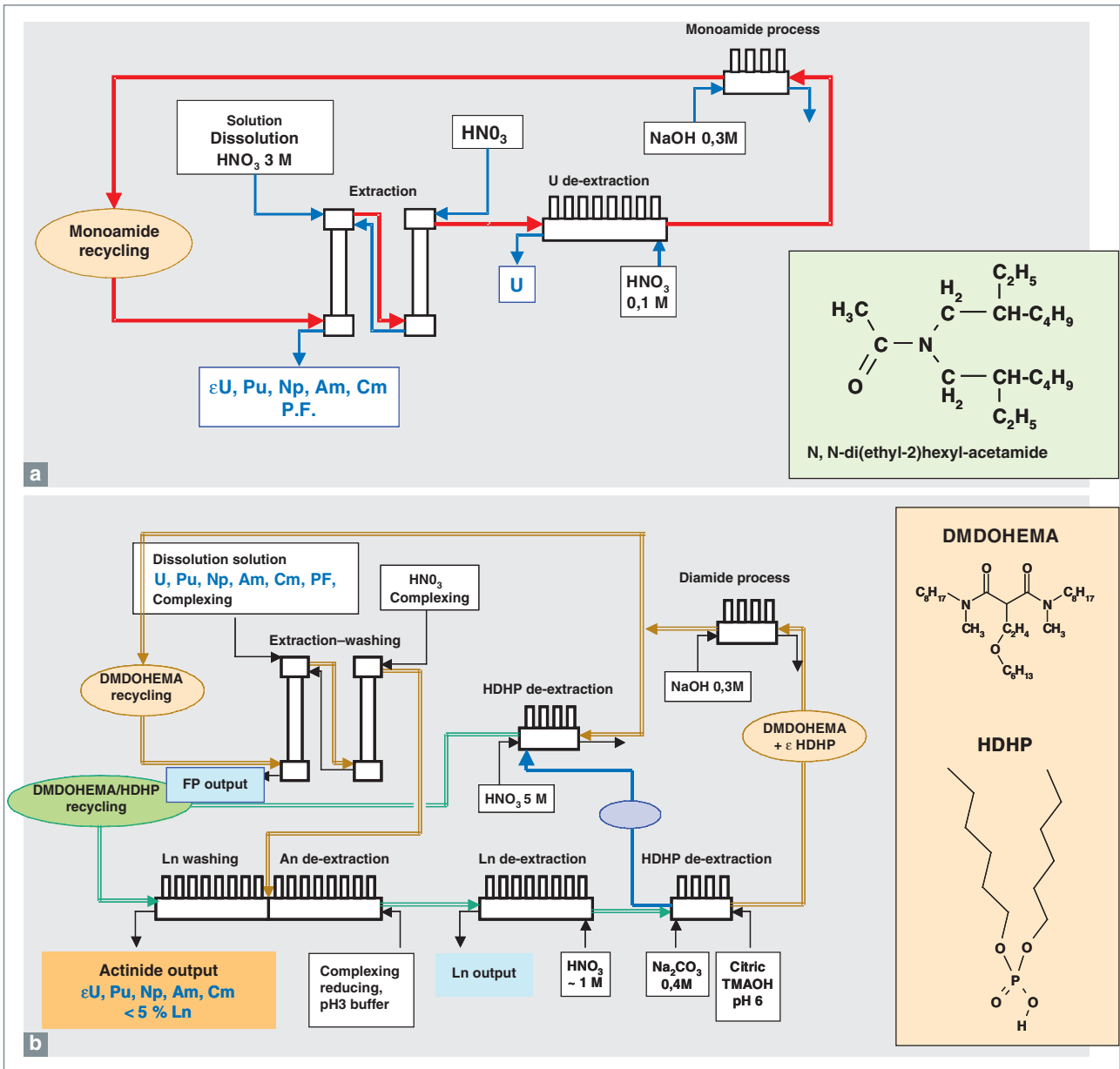

Fig. 132. Diagrams of the grouped actinide separation processes considered: (a) Partial separation of uranium. (b) Separation of remaining actinides.

Another process based on the internal gelation principle and developed at a lesser scale for the fabrication of nuclei should at least partially solve these problems.

According to this process, hydrolysis of the actinides is initiated within the sol drop by thermal decomposition of an ammonia precursor (hexamethylenetetramine) solubilized in the sol. This favors the co-condensation of actinides, even under different oxidation conditions, and enables the preparation of gel beads in more diluted ammonia baths. This process also enables the production of actinide nuclei with a larger diameter. A basic diagram of the internal gelation

process is shown in Figure 133. This process is applicable to both stable and reduced actinide oxidation conditions. It has been developed on the basis of tests in the presence of Ce(III) and U(IV) and subsequently tested within the scope of U-Pu co-conversion in a ratio of 85/15 using two modes: gelation of a U(VI)-Pu(IV) mixture, and gelation of a U(IV)-Pu(III) mixture. Within the scope of fuel refabrication, the first mode corresponds to a U(VI)-Pu(IV)-Np(V,VI)-Am(III)-Cm(III) co-conversion process having the advantage of considering oxidation states initially stable in a nitric medium, but suggesting a predictable limitation as regards the complete hydrolysis of minor actinides, particularly Np.

The second mode corresponds to a U(IV)-Pu(III)-Np(IV)-Am(III)-Cm(III) co-conversion process in a reducing medium, with optimised implementation conditions required for the simultaneous and homogeneous gelation of actinides (IV) and (III), which has been hardly investigated so far. Figure 134 shows an image of the tests performed in the ATALANTE facility for the formation of uranium and plutonium hydroxide droplets immediately after injection into the heated substrate, and two images of the U(VI)-Pu(IV) and U(IV)-Pu(III) hydroxide gel microspheres formed. These tests are being followed by an investigation of the thermal treatment conditions of these microspheres to achieve mechanically resistant actinide oxide nuclei. The tests completed so far have enabled the identification of a range of optimal conditions for the two major actinides. Tests to study the behavior of minor actinides Np(V,VI) and Am(III) are planned as of 2005.

2. Oxalic process

Metallic cations with oxidation levels III and IV interact with oxalate anions to form complexes with low solubility in nitric acid solutions. Already adopted industrially for the conversion of plutonium nitrate into oxide, this property has been considered for U-Pu co-conversion operations, and more recently for the grouped co-conversion of actinides U-Pu-Np-Am-Cm [4] according to the following global chemical reaction:

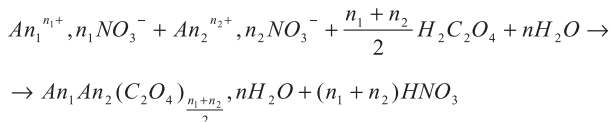

Precipitation conditions under batch or continuous conditions (concentration, acidity, hydrodynamics, etc.) and thermal treatment conditions under controlled atmosphere have been defined for various actinides, first separately with uranium and plutonium, and then as a mixture (U-Pu, Pu-Np, Pu-Am and U-Pu-Np) in various proportions to obtain precipitation efficient-

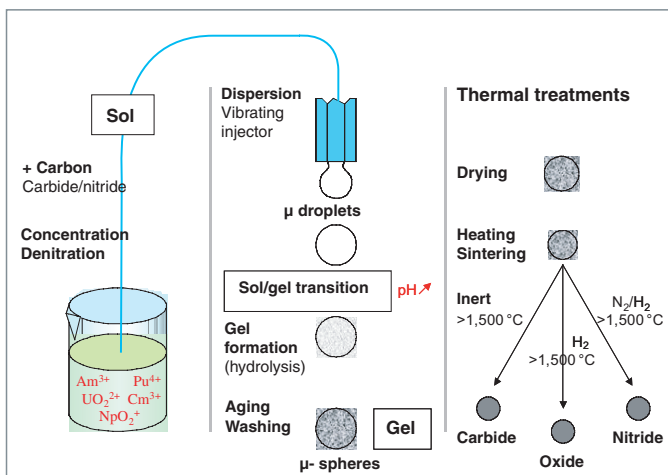

Fig. 133. Basic diagram of actinide co-conversion by internal gelation.



Fig. 134. Co-conversion of uranium and plutonium in a ratio of 85/15 by internal gelation.



Fig. 135. Actinide co-conversion tests performed in the ATALANTE facility.

cies in excess of 99%. Figure 135 shows images of some of the actinide co-conversion tests performed in the laboratory.

The test results are encouraging, with excellent precipitation efficiencies and structural analyses clearly indicating the formation of a solid actinide solution. For example, batches of several tens of grams of $(\text{Pu}, \text{Am})\text{O}_2$ with americium contents of 20 to 80% have been produced using this technique within the scope of FUTURIX experiments.

Targeted and relevant experimental data is required to optimise the process, given the implication of all actinides. Modeling the process based on the coupling of chemical engineering aspects (instrumentation and hydrodynamics) and precipitation chemistry is an essential step. A first complete model of oxalic precipitation has been finalized based on the experiments conducted in the ATALANTE facility, the operating experience feedback from industrial equipment and recent progress in numerical models. Figure 136 shows a numerical simulation of the oxalic precipitation of actinides.

Simultaneously with this study, the step involving mixed oxalate calcination to oxide has also been monitored through the analysis of decomposition reaction gases by gas-phase microchromatography and mass spectrometry with a view to obtaining safety data indicative of the oxalic co-conversion process. The mechanisms involved are globally relatively complex and strongly dependant on the oxalate structure, the metals present in the precipitate, and the calcination atmosphere used. The gases identified are mainly H_2O , CO , and CO_2 and, in lesser quantities, N_2 , NH_3 and H_2 .

Future studies for the development of the oxalic co-conversion process will concern the following: grouped actinide co-precipitation chemistry, process engineering aspects, adaptation of thermal treatments to obtain oxide, carbide or nitride compounds, and acquisition of sufficient data for safety demonstrations with a view to industrial implementation.



Fig. 136. Numerical simulation of the oxalic precipitation of actinides in a vortex reactor (a) and experimental setup (b) associated with granulometric monitoring of the precipitate. (L_{43} indicates the mean volumic diameter of the uranous oxalate agglomerations.)

Pyrometallurgical processes

The properties generally attributed to molten halogene salts (*i.e.*, etching and dissolution of compounds generally resistant to nitric acid, high radiolysis resistance, low neutron moderation capacity) allow for working with highly irradiating and strongly enriched fuels. This ensures the implementation compactness of **pyrochemical*** treatment processes, thus offering an interesting alternative to hydrometallurgical processes. As in the case of the latter, the main challenge is the complete, integral separation and recovery of actinides from a salt bath, upstream of the refabrication step. The process with the highest potential for performing this operation is chemical reducing extraction by a molten metal. $\text{LiF-AlF}_3/\text{Al-Cu}$ is one of the binary systems of interest for this separation. This system

exhibits a high selectivity for the extraction of actinides from fission products and a high solubility of actinides in aluminum [5].

Actinide separation tests have been performed in the ATALANTE facility at 830 °C using an LiF-AlF₃ salt bath (85/15) loaded with lanthanides (lanthanum, cerium, samarium and europium) with Pu/Ln ratio of 3, and an Al-Cu alloy (78/22). The table below shows the distribution coefficients (D) measured for the various metallic elements in the salt and metallic alloy, and the actinide/lanthanide separation factors ($S_{Pu/M}$) obtained after contact and phase equilibrium. Figure 137 shows the batch contactor used for the tests, and images of the salt before and after actinide extraction.

First results of initial tests for the selective separation of minor actinides in lanthanides from a fluoride salt using molten aluminum

Metal	Distribution coefficient* (D)	Separation coefficient ($S_{Pu/M}$)
Pu	197±30	1
Am	144±20	1.4±0.4
Ce	0.14±0.01	1,307±308
Sm	0.06±0.1	3,177±760
Eu	<0.013	>15,000
La	<0.06	>3,000

* The distribution coefficient D of an element is defined as the ratio of its mass concentration in the metal to its mass concentration in the salt under thermodynamic equilibrium. It represents the element's affinity for the medium considered (the higher the value of D, the stronger the element's affinity for the medium). The separation coefficient is given by the ratio of two distribution coefficients.

These results confirm the excellent extraction of actinides from the salt by the aluminum and the high potential of this binary system for the separation of actinides and lanthanides. Under the test conditions applied, two or three contacts between the salt and the aluminum are sufficient to achieve actinide extraction efficiencies in excess of 99.9%. In order to fully demonstrate the feasibility of this process, two studies are conducted in parallel. The first of these studies involves testing the grouped extraction of actinides from a salt rich in fission products. A nuclearized molten salt / liquid metal batch contactor has been developed and manufactured for testing in the ATALANTE C10 shielded test environment (tests performed in 2005). The second study involves the completion of hydrodynamic phase analyses and the development of multistage contactors to achieve a technology suited for testing the separation of actinides in an irradiated fuel dissolution salt bath under real conditions, and transposable to industrial scales.

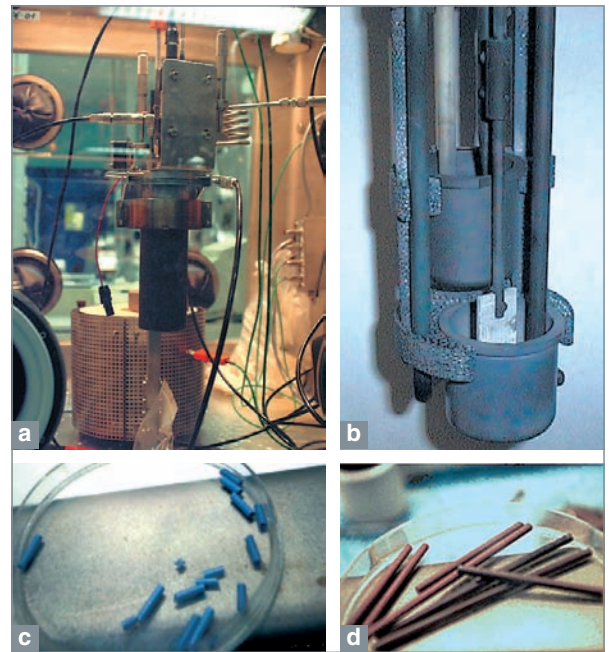

Fig. 137. Nuclearized batch contactor (a and b), and salt prior to contact (c and d) [blue color characteristic of Pu(III)] and after contact (brown color characteristic of lanthanides).

Technology and industrial implementation

The specific requirements for the GFR fuel, combined with the adoption of complete multirecycling of actinides and improved management of final waste, impose the need to deeply reconsider processing operations while striving to preserve an excellent economic competitiveness for the fuel cycle. The first tasks completed at the CEA consisted of identifying key or high-potential processes involving significant R&D efforts to demonstrate the feasibility of fuel cycle closure. These demonstrations are carried out in the ATALANTE facility. The first results obtained regarding the feasibility of key hydrometallurgical processes (destructuring of fuel elements by pulsed currents, grouped extraction and co-conversion of actinides, etc.) and pyrometallurgical processes (grouped extraction of actinides) are encouraging. These efforts must be pursued at least until the scientific demonstration of such processes has been achieved. The development of innovative processes is clearly important, but the technology required for their industrial implementation is equally important (size of equipment and host facilities, etc.). This is certainly the field where technological innovation will be most important, even primordial, for the development and control of an economically competitive GFR fuel cycle.

► References

- [1] T. TAKATA *et al.*, “Conceptual design study on advanced aqueous reprocessing system for fast reactor fuel cycle”, *Journal of Nuclear Science and Technology*, 41(3), 307-314, 2004.
- [2] B. BOULLIS, “Le cycle des systèmes nucléaires du futur”, *Revue générale nucléaire*, 93-97, 4, 2003.
- [3] Id., “Future nuclear fuel cycles : main stakes and guidelines for research”, *FJ/OH summer school on nuclear reactors “Physics, fuels and systems”*, August 25-September 3, 2004, Cadarache, France.
- [4] P. BARON, “Innovative fuel cycles : co-conversion of actinides by hydrometallurgical processes”, *FJ/OH summer school on nuclear reactors “Physics, fuels and systems”*, August 25-September 3, 2004, Cadarache, France.
- [5] Id., “Innovative fuel cycles : pyrochemical processes”, *FJ/OH summer school on nuclear reactors “Physics, fuels and systems”*, August 25-September 3, 2004, Cadarache, France.

Michel MASSON, Bernard BOULLIS

et Michaël LECOMTE,

Radiochemistry and Processes Department

GFRs for sustainable and clean nuclear energy

Today, nuclear power plants supply 16.5, 34 and 78% of the electricity consumed in the world, Europe and France, respectively. A simple analysis of the current rate of uranium consumption by existing nuclear power plants and of the amount of conventional uranium resources that can be mined for less than \$130/kg (estimated at 3.2 million tons) shows that significant dynamic tension can be expected in the uranium market within a few tens of years. An increase in installed nuclear capacity would further accelerate this process. Resorting to fast reactors, which use all the natural uranium (not just the fissile isotope), would help overcome this limitation.

Gas-cooled reactors (GCRs) could also enable a sustainable use of thorium (concept historically chosen by HTR designers in Germany). Synergies between U-Pu and Th-U 233 cycles could then be developed with a GCR fleet or a hybrid fleet associating GCRs and PWRs.

Scenario analysis applied to the case of France

Various nuclear fleet evolution scenarios are studied at the CEA. One such scenario, applied to the specific case of France, is discussed below. According to this scenario, it is assumed that the renewal of the nuclear fleet will occur in stepped intervals. Given the lifetime of current reactors, a first renewal of French Generation II reactors should take place between 2020 and 2050, with their replacement by Generation III PWRs and then by Generation IV systems (see Fig. 138). It is assumed that the total installed power capacity will remain constant. Generation III PWRs will be replaced by Generation IV systems (GFRs or SFRs*) after 60 years of operation, *i.e.*, as of 2080.

These dates could contribute to the rationalization of investments in nuclear fuel cycle plants, which will need to be renewed as of

2025 (reprocessing plants) and 2030 (MOX* fabrication plants).

In the scenario considered here, Pu mono-recycling in PWRs will be pursued until 2025, in accordance with the current strategy. From 2025 to 2035, UOX and MOX spent fuels will be stored and processed. From 2035 to 2050, fast reactor systems will recycle all actinides and absorb the stock and production of Generation II PWRs. 2080 will see the start of a second renewal phase where PWRs with a 60-year lifetime will be replaced by fast reactors.

The fissile and fertile fuel materials of the fast reactors introduced in 2035 will come from the processing of temporarily stored, spent PWR MOX or UOX fuels. Plutonium and minor actinides will be recycled in a grouped manner. Temporarily stored minor actinides resulting from the separation process implemented as of 2020 will be recycled within acceptable content limits: 5% for GFRs, 3% for SFRs. This mass of minor actinides will be progressively recycled in accordance with effective burn-up and content limits.

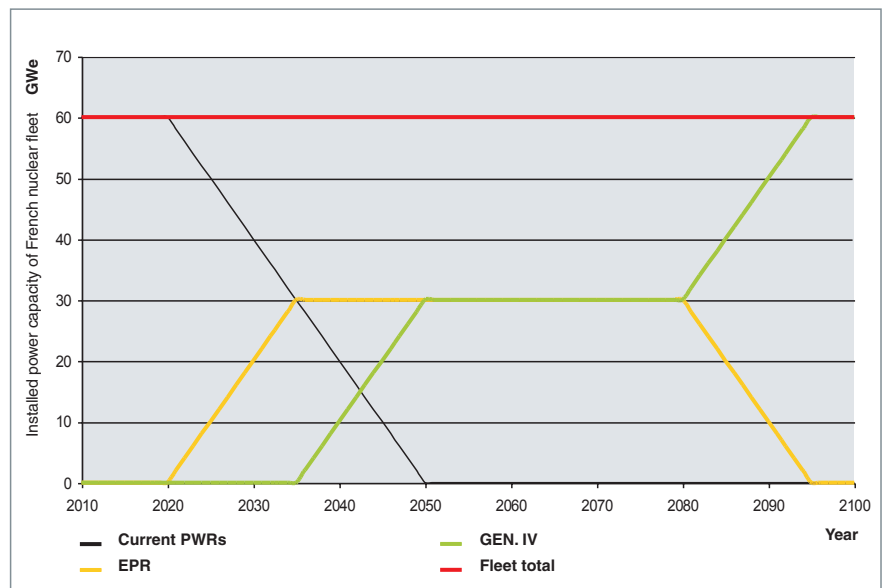

Fig. 138. French nuclear fleet renewal scenario (2010 to 2100). Current PWRs are progressively replaced by Generation III reactors (EPRs), and then by Generation IV reactors. The installed power capacity is kept constant.

In 2095, the nuclear fleet will be composed of only fast reactors. The introduction of GFRs will require maintaining or even increasing existing reprocessing capacities. Specific fuel cycle plants are to be introduced in 2030 (fuel fabrication) and 2040 (spent fuel processing in shielded environment), the latter date corresponding more or less to the renewal of the UP2 and UP3 plants at La Hague. According to analysis, the schedule for the renewal or extension of spent fuel processing and MOX fuel fabrication facilities is compatible with the phased introduction of fast reactors.

The commissioning of Generation III EPR-type reactors as of 2020 (for at least 60 years) and the objective to reduce the quantity of actinides in final waste both impose the need to maintain a processing capacity for the UO₂ fuel used in these reactors, and therefore to at least renew existing plants, including all service systems.

Generation IV plants should allow the processing of spent UOX fuels and Generation IV reactors fuels as of 2030-2040, on the basis of a grouped extraction of all actinides (with preliminary extraction of part of the uranium). Two shearing-dissolution facilities specific to each fuel type will be required at the head end of the process, and the separation facility will need to be transformed so as to be suited for a GANEX* type process (after partial reduction of uranium flow). The outgoing product would then consist of a mixture of uranium and transuranians, supplemented with uranium in quantities suitable for the fabrication Generation IV reactor fuels. This modular design is based on the GANEX process, currently subject to a large-scale research and test program at the CEA to be completed by 2012.

The results of this scenario are presented in Table below. The Pu inventory available in France stabilizes at approximately 800 tons, a quantity sufficient for both SFRs and GFRs. Under homogeneous equilibrium recycling conditions, the fuel contains approximately 1.2% minor actinides (Np + Am + Cm) and 20% Pu. Nevertheless, the stock accumulated during the transition period can be recycled in SFRs with a maximum minor actinide content of 2.5 to 3%.

The introduction of GFRs accepting a maximum content of 5% will increase the instantaneous consumption of minor actinides and thereby reduce the inventory more rapidly. The recovery time for the minor actinides from spent PWR fuels, separated and temporarily stored as of 2020, is approximately 15 years, with recycling in GFRs or SFRs as of 2035. The minor actinide inventories in 2100 (*i.e.*, after 5 years of operation of a nuclear fleet composed only of fast reactors) are fairly close to those in 2035, date of introduction of fast reactors (50% of the fleet in 2050-2080), with the exception of curium.

According to this scenario, fast reactor systems will reduce natural uranium requirements in the 21st century by approximately 50%. This Figure is directly related to their share of the total electricity produced by nuclear reactors.

Both fast reactor systems (GFRs or SFRs) can be introduced in the French nuclear fleet at constant power capacity by adopting a dynamic fuel cycle with reduced material residency time outside the reactor (approximately 2 to 3 years). In all cases, the implementation of the separation-transmutation process inherent to Generation IV systems significantly reduces final waste inventories.

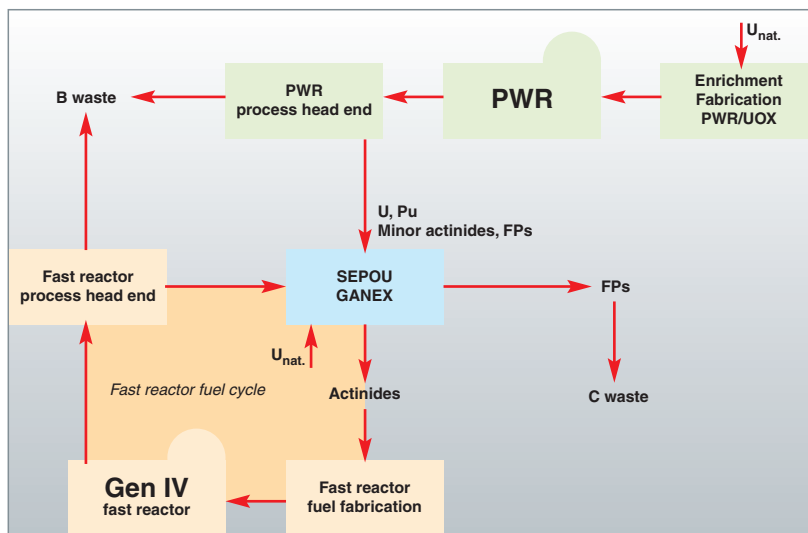

Fig. 139. Processing-recycling concept considered for a transition fleet composed of PWRs and Generation IV reactors. The SEPOU advanced separation process and GANEX grouped actinide separation process are currently being developed at the CEA.

Actinide inventory for a mixed PWR/fast reactor fleet*								
Inventories (t)	MOX mono-recycling in PWRs and global multirecycling (Pu, Np, Am, Cm, etc.) in SFRs				MOX mono-recycling in PWRs and global multirecycling (Pu, Np, Am, Cm, etc.) in GFRs with fuel rods and radial blanket (25% of GFR fleet)			
	2035	2050	2070	2100	2035	2050	2070	2100
Pu (Total)²⁸	448	567	682	809	454	577	698	815
Np	24	31	33	25	23	26	19	11
Am	53	71	75	63	50	56	45	39
Cm	4	7	10	18	4	7	12	14
Minor Act. (Total)	82	109	118	106	77	89	76	64

* According to the scenario described above. The comparison of GFRs and SFRs shows that this inventory is recycled more efficiently with GFRs.

Annual uranium consumption of French nuclear fleet at constant installed power capacity (60 GWe)*						
Annual uranium consumption (in tons)	MOX mono-recycling in PWRs and global multirecycling (Pu, Np, Am, Cm, etc.) in Generation IV fast reactors Scenario described in the present paper				MOX mono-recycling in PWRs	UOX in PWRs
	2035	2050	2080	2100	2035 to 2080	2035 to 2080
Natural uranium	6,900	3,450	3,450	0	6,900	7,900
Depleted uranium	0	20	20	40	0	0

* Comparison between the scenario described in the present paper (left column) and two situations without introducing fast reactors in the nuclear fleet, *i.e.*, with MOX mono-recycling in PWRs (middle column) and without recycling (right column).

As shown in Table above, introducing the closed fuel cycle of Generation IV systems also significantly reduces natural uranium requirements.

The commissioning of Generation IV fast reactor systems in the 21st century will make it possible to economize natural resources and minimise the production of long-lived radioactive waste. GFRs are particularly suited to achieve these objectives within a reasonable timeframe.

Marc DELPECH

Nuclear Development and Innovation Directorate

28. Total = Interim storage, reactors, plants, storage.

Glossary – Index

Actinides: rare earth element group with atomic numbers 89 to 103, corresponding to electronic sublayers 5f and 6d. Actinides have very close chemical properties. [45-47](#), [61-68](#), [110](#), [115](#), [135-139](#), [146-155](#).

Activation: action tending to make certain **nuclides*** **radioactive*** when bombarded by **neutrons*** or other particles, particularly within reactor structural materials. [35](#), [69](#), [70](#), [81](#), [98](#), [110](#), [111](#), [127](#).

Adiabatic: refers to a system where transformations occur without exchange of heat with the external medium.

Aerosol: suspension of very fine solid or liquid particles in a gas.

Allotropic: refers to a solid with a crystalline structure that is thermodynamically stable under certain temperature and pressure conditions. In an allotropic transformation, this stable crystalline structure is transformed to another structure. [27](#).

ANTARES: see section “Energy conversion in 4th generation gas-cooled reactor system” (p. 89). [91](#).

ATALANTE: see section “GFR fuel cycle: Innovative processing methods” (p. 145). [146-151](#).

Austenitic (structure): Face-centered cubic crystalline structure observed in certain metallic alloys, particularly steels. [129](#).

AVR: see section “The recent past and near future of gas-cooled reactors: HTRs” (p. 33). [37-39](#), [66](#), [85](#), [112](#).

Azeotrope : constant boiling point mixture obtained in the distillation of binary liquid mixtures. The components of an azeotropic mixture cannot be separated by a simple distillation. [107](#).

Barn: unit used to measure a cross section ($1 \text{ barn} = 10^{-24} \text{ cm}^2$). [49](#), [72](#).

Barriers: various physical components used in a nuclear reactor to isolate the **radionuclides*** contained in the fuel from the environment. In a **pressurized water reactor***, they successively consist of the fuel element cladding, primary circuit containment (including the reactor vessel) and reactor containment. [22](#), [34](#), [46](#).

Benchmark: reference value.

Brayton (cycle): see section “Energy conversion in 4th generation gas-cooled reactor system” (p. 89).

Breeder: system producing more **fissile*** fuel than it consumes. The new fissile nuclei are created through **fission* neutron*** capture by **fertile*** nuclei (non-fissile under the effect of thermal neutrons) after a number of radioactive disintegrations.

Breeder reactor: see **Breeder***

Burn-up: strictly speaking, it corresponds to the percentage of heavy atoms (uranium and plutonium) that have undergone **fission*** during a given time period. It is commonly used to determine the thermal energy produced in a reactor per unit mass of fissile material, between fuel loading and unloading operations. It is expressed in megawatt-days per ton (MWd/t). The **discharge**

Burn-up* is the value after which a fuel assembly must be effectively unloaded (*i.e.*, after several irradiation cycles).

Burn-up fraction: total energy released per unit mass of nuclear fuel. Generally expressed in megawatt-days per ton. [33](#), [46](#), [61](#), [110](#), [135](#), [145](#).

Calculation code: set of mathematical expressions encoded in a computer program (or code), providing a simplified representation (model) of a system or process for the purpose of simulating it.

Capture (radiative capture): capture of a neutron by a nucleus, followed by immediate emission of gamma radiation. [27](#), [35](#), [36](#), [49](#), [53](#), [61](#), [70](#), [109](#), [116](#), [136](#).

CerCer: ceramic-ceramic composite material. [127](#).

Cladding: envelope surrounding the fuel material, intended to ensure its insulation and mechanical resistance within the reactor core. [22](#), [23](#), [116](#), [117](#), [127](#), [130](#), [145](#).

Control rod: rod or assembly or rods containing a material that absorbs neutrons and, depending on its position inside a nuclear reactor core, influences its reactivity. [52](#), [116](#), [122](#).

Conversion factor: ratio between the number of fissile nuclei produced and destroyed in a core or portion of a core. A reactor is said to be an **isogenerator*** when its conversion factor is equal to 1, and a **breeder*** when its conversion factor is greater than 1. [113](#), [115](#).

Coolant: fluid (gas or liquid) used to extract the heat produced by **fission***. [7](#), [24](#).

CO₂: see section “The first gas-cooled graphite-moderated reactors: History and performance” (p. 21).

Cogeneration: use of the thermal energy of a reactor for several joint purposes (*e.g.*, production of electricity, hydrogen, drinking water through desalination, and cold for air conditioning). [41](#), [91](#), [94](#).

Conditioning (of waste): operation through which nuclear waste is kept in stable and sustainable form. [37](#), [65](#), [66](#), [69](#), [139](#).

Control rod cluster: see **control rod***.

Core: region of a nuclear reactor in which a nuclear chain reaction may occur. [22](#), [49](#).

Creep: progressive deformation of a solid under the effect of a stress field applied for long periods of time. Creep may be activated by heat (thermal creep) and/or irradiation. [31](#), [35](#), [77-82](#), [100](#), [128](#), [129](#), [133](#), [138](#).

Critical: a system is said to be critical when the number of **neutrons*** emitted by **fission*** is equal to the number of neutrons that disappear by absorption or leakage. In such cases, the number of fissions observed during successive time intervals remains constant (exact equilibrium). [52](#), [119](#).

Criticality excursion: rapid increase in the number of fissions in a fissile medium. Also referred to as power excursion.

Critical mass: minimum mass of fissile material nuclei required in order for the number of neutrons produced during a chain reaction to equal the number of neutrons absorbed.

Cross section: measurement of the probability of an interaction between an incident particle and a target nucleus, expressed in **barns*** (1 barn = 10^{-24} cm²). For example, in the case of a **neutron***, it defines the probability of its interaction with the nuclei of the various core constituent materials. In nuclear reactors, neutron-induced reactions are mainly considered: fission, capture and elastic scattering. **27, 49, 51, 70, 86.**

Delayed neutrons: neutrons* emitted by **fission*** fragments, with an average delay of a few seconds after fission. Even though they only account for less than 1% of emitted neutrons, delayed neutrons are essential for the control of nuclear reactors. See **effective beta***. **111.**

Desalinization (of sea water): see section “Very High-Temperature Reactors (VHTRs): Numerous benefits of higher temperatures” (p. 71).

Deterministic calculation (of neutron variables): numerical solution of the equation governing **neutron* transport*** in matter, after “discretization” of variables (space, neutron energy and time), *i.e.*, conversion into distinct quantities. **52.**

Divergence: start of the **chain reaction*** process in a reactor. **21, 37, 52.**

Doubling time: parameter often used to quantitatively describe the deployment capacities of a reactor series. It is the time taken by a breeder reactor to produce as much fissile material as it initially contained. It is also the time after which the reactor fleet can be doubled using the excess fissile material. **110.**

dpa: number of displacements per atom induced in an irradiated material. Unit of measurement well-suited for the quantification of irradiation in metals. **77, 81, 127-130.**

Ductility: ability of a material to undergo plastic deformation. **77, 81, 128, 138.**

Effective beta: fraction of delayed neutrons, generally expressed in **pcm*** (per cent mille). Certain fission products generated in the reactor core emit neutrons with a delay of up to a few tens of seconds after fission. These neutrons only contribute marginally to the neutron balance, but they are essential for controlling and stabilizing the chain reaction.

EFPD: unit of reactor operating time, expressed in “Equivalent Full Power Days”. **38.**

Electron volt (eV): unit of energy used in nuclear physics. 1 eV = 1.6×10^{-19} Joules.

Enrichment: the use of various processes (gaseous diffusion, ultracentrifugation, selective laser excitation) to increase the concentration of the uranium-235 **isotope*** with respect to the uranium-238 isotope predominant in natural uranium. **21.**

Epithermal (neutrons): neutrons in the 10 eV to 20 keV energy range, therefore having a higher velocity than thermal neutrons. **49.**

EPR: European Pressurized Reactor. **19, 33.**

ETDR: technological research and development reactor. CEA project for the study of gas-cooled reactors. See section “The proposed Experimental Technology Development Reactor (ETDR)” (p. 141).

Fast neutrons: neutrons* released during fission, traveling at very high speed (20 000 km/sec), with an energy of approximately 2 MeV. **10.**

Fast reactor (FR): reactor with no **moderator***, where most fissions are generated by **neutrons*** with energy levels of the same order of magnitude as those produced by fission. **19, 153-155.**

Fertile: refers to a material whose nuclei yield **fissile*** nuclei when they absorb neutrons. This is the case with uranium-238, which yields plutonium-239. Otherwise, the material is said to be **sterile***. **34, 61, 109.**

FIMA (Fissions per Initial Metal Atom): unit representing the burn-up of a nuclear fuel, expressed as the proportion of fissions obtained in a population of heavy metal atoms. **46, 135, 136, 138.**

Fissile (nucleus): nucleus capable of undergoing **fission*** by **neutron*** absorption. Strictly speaking, it is not the so called “fissile” nucleus that undergoes fission, but rather the compound nucleus formed after neutron capture. **7, 33-36, 45, 46, 61-63, 109-111, 118, 135-139, 145, 146.**

Fission products: nuclides* generated either directly through nuclear fission, or indirectly through the **disintegration*** of fission fragments. **7, 34-36, 45, 46, 65-68, 85-87, 135-138.**

Fluence: dose unit used to quantify the irradiation of materials. It is the number of incoming particles (*e.g.*, neutrons) per surface unit during irradiation. **29-31, 81, 127-138.**

Fort Saint Vrain: see section “The recent past and near future of gas-cooled reactors: HTRs” (p. 33).

Fuel: substance constituting the **core*** of a nuclear reactor, containing the **fissile elements*** necessary to sustain the **chain reaction** within the core. **45, 61, 85, 109, 135.**

Fuel cycle: series of stages undergone by fuel, from ore extraction to waste disposal. **61, 109, 145.**

GANEX: chemical process for the grouped extraction of **actinides***. **138.**

GCR: gas-cooled (CO₂) graphite-moderated, natural uranium reactor series. See section “The first gas-cooled graphite-moderated reactors: History and performance” (p. 21).

Generation (of reactors): see “Introduction” (p. 7).

Generation IV International Forum (GIF): international collaboration aimed at developing 4th generation nuclear systems. **7, 13.**

Generation time: average duration between two successive fissions.

GFR: gas-cooled fast reactor. See section “The GFR system: Fuel cycle closure” (p. 109).

Glove box: chamber in which materials can be handled while remaining effectively sealed off from the operator. Handling operations are performed through sealed glove openings in the chamber wall. The chamber is generally slightly pressurized to contain radioactive substances. **143.**

Graphite: see section “Graphite: a fascinating material” (p. 27).

Group: in neutronic calculations, cross-section energy variations are generally taken into account in a simplified manner by averaging them among a few energy domains, referred to as “groups”. **54.**

GTHTR-300: see section “The recent past and near future of gas-cooled reactors: HTRs” (p. 33).

GT-MHR: Gas-Turbine Modular Helium-cooled Reactor. **33.**

GWe: electrical power delivered by a power plant, expressed in gigawatts.

GWth: thermal power delivered by the same power plant, expressed in gigawatts.

Half-life: time during which half the **radioactive*** atoms initially present disappear as a result of natural disintegration. **70.**

Heat exchanger: system wherein a hot fluid transfers its heat to a cold fluid. **9-10, 22, 23, 39-42, 77-80, 90, 91, 101, 102, 124, 125, 141, 142.**

Heavy nuclei: term referring to **isotopes*** of elements whose number of protons (atomic number) is equal to or greater than 80. All **actinides*** and their daughter products belong to this group. **7.**

Heavy water: deuterium protoxide (D₂O). **21.**

Helium: see section “The first gas-cooled graphite-moderated reactors: History and performance” (p. 21). **25.**

High temperature materials: see section “Materials for Very High-Temperature Reactors (VHTRs)” (p. 77).

Hot duct: in a gas-cooled reactor, the hot duct is the piping branch that connects the reactor core to the energy conversion system and conveys the high-temperature gas. **77, 80, 97.**

HTE: High Temperature Electrolysis. **103, 104.**

HTR-MODUL: see section “The recent past and near future of gas-cooled reactors: HTRs” (p. 33).

HTR-10: see section “The recent past and near future of gas-cooled reactors: HTRs” (p. 33).

HTTR: see section “The recent past and near future of gas-cooled reactors: HTRs” (p. 33).

Hydrogen: see section “Nuclear production of hydrogen?” (p. 103).

Irradiated materials: see section “Materials for Very High-Temperature Reactors (VHTRs)” (p. 77). **127.**

Isogenerator: system producing as much fissile fuel as it consumes (see “BreederSM”). **116.**

Isotopes: different forms of a same element whose nuclei have an identical number of protons but a different number of neutrons.

ITER: prototype reactor for the study of controlled thermonuclear fusion, subject to international collaboration. **11.**

Jules Horowitz Reactor (JHR): see section “The proposed Experimental Technology Development Reactor (ETDR)” (p. 141).

Kinetics (reactor kinetics): Rate at which changes in power occur.

k_∞: see **Multiplication factor***.

k_{eff}: see **Multiplication factor***.

Labile release: fraction of radionuclide inventory prone to instantaneous release when water comes into contact with irradiated fuel. This phenomenon mainly concerns soluble fission products in solution and does not depend on the containment properties of the various layers of irradiated fuel. It essentially depends on water accessibility and fission product quantities segregated or sorbed outside the fuel. **67.**

Lanthanide: rare earth **element*** group with atomic numbers 57 to 71, corresponding to electronic sublayer 4f. Lanthanides have very close chemical properties, and also very close physical prop-

erties to those of **actinides***. The separation of actinides and lanthanides in spent nuclear fuel constitutes a major challenge. **147, 151.**

Leaching: dissolution of a solid body. **66, 67.**

Light water: ordinary water, as opposed to **heavy water***.

Light water reactors: family of reactors comprising **pressurized water reactors*** and **boiling water reactors***. **44.**

Magnox: aluminum-magnesium alloy used as cladding material, particularly in certain British CO₂-cooled reactors (also referred to as Magnox reactors).

Major actinides: uranium and plutonium nuclei present or formed in nuclear fuel.

Martensitic (structure): centered cubic crystalline structure observed in certain metallic alloys, particularly steels. **77, 78.**

Material buckling and geometric buckling: in elementary neutron theory, flux (*i.e.*, spatial distribution of neutrons) is a solution of Laplace’s equation. This solution must take shape and dimensions of the reactor into account, as well as the characteristics of its constituent materials. These two aspects can be formulated by an equality expressing the critical condition of the system: geometric buckling = material buckling, where the first term is a parameter expressing the geometrical constraints and the second is a parameter expressing the material capacity to regenerate neutrons.

MeV: Mega electron Volt. Unit of energy generally used to express the energy released by nuclear reactions. 1 MeV corresponds to 1.6 x 10⁻¹³ Joules.

Migration area: area expressed in m², corresponding to the mean square of the distance traveled by neutrons in the reactor core, from their emission to their absorption. **49.**

Minor actinides: heavy nuclei formed in a reactor by the successive **capture*** of **neutrons*** by fuel nuclei. The main **isotopes*** involved are neptunium (237), americium (241, 243) and curium (243, 244, 245).

Moderation ratio: in a reactor, the ratio of the volume of the moderator (water in the case of **PWRs*** in particular) to that of the fuel. This ratio determines the mean energy of the neutrons. **35, 49, 50, 61.**

Moderator: material composed of light nuclei that slow down **neutrons*** through elastic scattering. The moderator must have a low capture potential so as to not “waste” neutrons, and it must be sufficiently dense to effectively slow them down. **21.**

Monte Carlo method: statistical method to obtain an approximate integral value using a set of points randomly distributed according to a certain probability. It consists of repeating the assignment of a numerical value according to the various stages of a process involving randomness, and then calculating the average value and statistical deviation (reflecting accuracy) for all the values obtained. When applied to particle **transport*** problems, it consists of simulating the displacement of a very large number of particles, taking into account geometry and nuclear interactions, and then recording the results of interest. **50-55, 132.**

MOX (Mixed Oxides): mixture of uranium (natural or depleted) and plutonium oxides. **36, 45, 62, 67, 110, 153-155.**

Multigroup: see **Group***

Multiplication factor k: mean value of the number of new fissions induced by the **neutrons*** produced by an initial **fission***. When evaluating the multiplication factor, if neutron leakage to neighbor-

ing fuel assemblies or outside the reactor is not taken into consideration, the multiplication factor is referred to as infinite and noted k_{∞} . Otherwise, it is referred to as effective and noted k_{eff} .

Negative reactivity: decrease in **reactivity*** caused by the insertion of a neutron absorber (eg, control rod) in the reactor core.

Neutron balance: balance of neutrons produced and lost in a reactor. [22](#), [49](#), [50](#), [117](#).

Neutron flux: number of neutrons passing through a surface unit per unit time. [130](#), [136](#), [144](#).

Neutronics: Study of **neutron*** displacements and resulting reactions in **fissile*** and non-fissile materials, particularly in nuclear reactors, *i.e.*, in terms of their multiplication and the initiation and control of **chain reactions***. [49](#).

Neutron spectrum: energy distribution of a **neutron*** population in a reactor core. [46](#), [49](#), [51](#), [61](#), [69](#), [116](#), [125](#).

NGNP: Next Generation Nuclear Plant. Gas-cooled reactor prototype (**VHTR***) currently developed at the Idaho National Laboratory (USA). [74](#).

Nuclear safety: set of protective measures to prevent hazards associated with nuclear activities and/or facilities by assessing and controlling related risks. See section p. 57 et p. 121.

Particle fuel: see section "Particle fuel" (p. 45).

PBMR: Pebble Bed Modular Reactor. See section "The recent past and near future of gas-cooled reactors: HTRs" (p. 33).

Pcm: per cent mille. Unit of reactivity. [50](#), [52](#), [55](#), [116](#), [118](#), [125](#), [142](#).

Peach Bottom: see section "The recent past and near future of gas-cooled reactors: HTRs" (p. 33).

PHENIX: sodium-cooled **fast reactor*** prototype. [10](#), [130](#), [137](#), [138](#), [141](#).

Plutonium: element formed through neutron capture by uranium in a nuclear reactor core. Odd-numbered plutonium **isotopes*** are **fissile***, which makes plutonium a valuable nuclear material (as **MOX*** fuel, for example). [7](#), [61-63](#), [145](#), [153](#).

Point defect: localized defect in a crystalline network, due to a missing atom (vacancy), an additional atom located between two normal atomic positions (interstitial site), or a foreign atom replacing one of the atoms in the network. [28-30](#), [67](#), [128](#).

Potential radiotoxicity (of a certain quantity of radionuclides, *e.g.*, in waste): radionuclide inventory multiplied by ingestion dose factor, indicating the potential harmfulness of a given quantity of radionuclides under accident conditions. [7](#), [65](#), [68](#), [110](#), [127](#).

Power map: 3D representation of the power distribution at various locations in a reactor core (*e.g.*, for each fuel assembly). [116](#).

Probabilistic calculation (of neutron variables): use of the **Monte Carlo method*** to simulate neutron "histories", from birth to absorption. [52](#).

Processing (of spent fuel): operation consisting of separating usable and unusable spent fuel materials, after which the unusable materials are considered as waste and conditioned accordingly. See section "GFR fuel cycle: Innovative processing methods" (p. 145).

Proliferation: uncontrolled dissemination of military nuclear technologies (or materials used in such technologies). [7](#), [13-15](#), [17-19](#), [68](#), [110](#), [145](#).

Prompt neutrons: neutrons* emitted immediately upon **fission***. [111](#).

Pyrocarbon (or pyrolytic carbon): amorphous carbon produced by high-temperature decomposition of gaseous hydrocarbons. Pyrocarbon is used as a coating layer for particle fuels. [46](#), [48](#), [85](#).

Pyrochemistry: high-temperature chemistry (several hundred degrees C). Pyrochemistry does not involve water or organic molecules, only liquid metals and molten salts. [138](#), [145](#).

Pyrophoric: refers to a material capable of spontaneous ignition in air. [136](#).

Pressurized water reactor (PWR): reactor where heat is transferred from the core to the heat exchanger through water maintained at high pressure in the primary circuit to prevent boiling. [19](#), [33](#).

Radiolysis: breakdown of matter by ionizing radiation. [23](#), [35](#), [67](#), [131](#), [147](#), [151](#).

Radionuclide inventory: quantities of fission products and **actinides*** contained in irradiated fuel, generally expressed in Bq/gIHM (Becquerels per gram of initial heavy metal) or g/IHM (grams per ton of initial heavy metal). These quantities and the associated isotopic spectra depend on various parameters, such as fuel type and irradiation conditions (burn-up, etc.). [154](#), [155](#).

Reactivity: dimensionless quantity used to measure slight variations of the **multiplication factor k^*** with respect to the critical value. It is defined by the formula $\eta = (k - 1)/k$. It has a very small value, usually expressed in pcm (per cent mille). The reactivity is zero for a **critical*** reactor, positive for a **supercritical*** reactor and negative for a **subcritical*** reactor. [35](#), [36](#), [50](#), [52-55](#), [58](#), [59](#), [62](#), [63](#), [111](#), [116](#), [119](#), [122](#), [125](#), [142](#).

Reactivity coefficient: variation of the **multiplication factor*** due to reactor operation, *i.e.*, changes in temperature and composition due to release of energy and neutron irradiation.

Reactor coolant: coolant* fluid used to remove heat from the core. [67](#).

Reactor series: possible path for the development of nuclear reactors capable of producing energy under industrial conditions. [34](#).

Recycling: reuse (in a nuclear reactor) of nuclear materials derived from the **processing*** of spent fuel. [10](#), [61](#), [109](#), [145](#).

Residual power: thermal energy developed in a nuclear reactor during shutdown, mainly due to the **activity*** of **fission*** products. [36](#), [39](#), [40](#), [57](#), [59](#), [111](#), [112](#), [121-124](#).

Resonance: term used in Nuclear Physics, referring to the excited state of the composite nucleus formed by the addition of a target nucleus and an incident nucleus. In certain incident energy domains, the neutron-nucleus interaction cross sections strongly depend on the energy of the neutron, due to the existence of such resonance states. [49](#), [50](#), [125](#).

RIA: Reactivity Insertion Accident

Rod: low-diameter tube sealed at both ends, constituting a nuclear reactor core when it contains fissile, fertile or absorbent material. When it contains fissile material, it is referred to as a **fuel element***. [49](#), [115](#).

Self-shielding: preferential absorption of neutrons by heavy atoms at the periphery of a fuel mass. Depending on the fuel geometry, this absorption phenomenon may more or less reduce neutron penetration inside the fuel. [61](#).

Separation: chemical process through which the various constituent elements of spent fuel are separated. The PUREX process isolates the uranium and plutonium. Other more advanced chemical processes (DIAMEX, SANEX, GANEX) are currently being studied to separate **actinides*** from lanthanides, or **actinides*** from one another. [68](#), [115](#), [139](#), [146-148](#), [151](#), [152](#), [154](#).

Sintering: operation consisting of welding the grains of a compacted metal or ceramic powder by heating this powder beyond the melting temperature of the material. [47](#), [69](#), [82](#), [83](#), [136](#), [139](#), [149](#).

Streaming: neutron leakage in certain preferential directions due to heterogeneities in the reactor core (e.g., gas channels). [50-53](#).

Temperature coefficient: coefficient reflecting a variation of the **multiplication factor*** in a reactor during a change in temperature. [36](#).

Tempering: thermal processing applied to certain materials (quenched metals and alloys in particular) to control their microcrystalline structure and mechanical characteristics.

Thermalization: slowing down of **neutrons*** so as to gradually place them in thermal equilibrium with the reactor material through which they are diffused.

Thermal neutrons: also referred to as slow **neutrons***, these neutrons are in thermal equilibrium with the material in which they travel (at approximately 2 to 3 km/sec). Their energy is less than 1 eV. [10](#).

Thermochemical cycle: in the context of the present monograph, a series of chemical reactions making use of a nuclear heat source to produce hydrogen from the breakdown of water molecules. [72](#), [103](#), [104](#), [106](#).

Thermohydraulics: branch of physics devoted to the study of heat transfer and fluid mechanics. [94](#), [110](#), [117-119](#), [123](#).

Thorium: fertile* element abundant in nature, usable in nuclear reactors with a **fuel cycle*** fairly similar to that of uranium-238. [19](#), [25](#), [38](#), [109](#), [153](#).

THTR-300: see section "The recent past and near future of gas-cooled reactors: HTRs" (p. 33).

TIG: refractory arc welding process with inert gas shielding, used to obtain a very high welding quality (pressure vessels). [78](#).

TOE: unit of energy corresponding to 1 ton of oil equivalent. [109](#).

Toughness: characteristic value of a material, expressed in MPa.m^{1/2}, indicating its resistance to crack propagation. [77](#), [81](#), [128](#), [130](#).

Transient: gradual or sudden evolution (scheduled or unscheduled) of the operating state of a system. In the case of a nuclear reactor, a distinction is made between normal transients, during which physical parameter values remain within technical operating specifications, and accident transients, which trigger the activation of protective and engineered safeguards. [38](#), [40](#), [59](#), [94](#), [102](#), [116](#), [123](#), [124](#).

Transmutation: use of a **neutron***-induced nuclear reaction (capture, **fission***) to transform one isotope into another (particularly a long-lived **radioactive*** isotope into a short-lived or stable isotope). [10](#), [14](#), [45](#), [110](#), [130](#), [132](#), [145](#), [154](#).

Transuranic elements: all elements with higher atomic number than uranium. In a reactor, they consist of heavy nuclei obtained from uranium through **neutron*** capture reactions or **radioactive disintegrations*** other than **fission***. They are classified into

seven **isotope*** families: uranium, neptunium, plutonium, americium, curium, berkelium and californium.

Tribology: study of solid friction, wear and lubrication. [97](#), [98](#).

TRISO: type of fuel particle composed of a fissile or fertile material core coated with four successive layers: porous pyrocarbon, dense pyrocarbon, SiC, dense pyrocarbon. [34](#), [45](#), [47](#), [48](#), [68](#), [74](#), [85](#), [87](#).

Turbine, turbomachine: see section "Energy conversion in 4th generation gas-cooled reactor system" (p. 89).

UOX: standard fuel used in **light water reactors***, composed of uranium oxide enriched with uranium-235. [45](#), [61](#), [62](#), [66](#), [67](#), [153-155](#).

Vessel (reactor vessel): recipient containing the reactor core and its coolant fluid. [38](#), [41](#).

VHTR: Very High-Temperature Reactor. See section "Very High-Temperature Reactors (VHTRs): Numerous benefits of higher temperatures" (p. 71).

Void coefficient: variation of the **multiplication factor*** in a reactor when the **moderator*** forms more voids (areas of lesser density, such as steam bubbles in water) than normal. If this coefficient is positive, excess steam generation will lead to an increase in **reactivity***, and therefore an increase in power. If it is negative, excess steam generation will tend to decrease the reactivity. [61](#).

Xenon effect: xenon is a powerful neutron absorber. Its formation in the reactor core (as the disintegration product of another fission product, i.e., iodine) causes a delayed disturbance of core neutron behavior during a power **transient***. [21](#), [58](#), [116](#).