

DE LA RECHERCHE À L'INDUSTRIE

cea



www.cea.fr

THE BAD AND THE GOOD OF PHYSICAL FUNCTIONS

Cryptarchi 2013, Fréjus

Bruno Robisson, Ingrid Exurville, Jean-Yves Zie, Hélène Le Boudier, Jean-Max Dutertre, Jacques Fournier, Jean-Baptiste Rigaud

24 JUNE 2013

Physical function

- Intuitive definition
- Mathematical definition : function
- Mathematical definition revisited : probability mass function (**pmf**)

Examples of probability mass functions

- Leakage function
 - Model based
 - Measures
- Error function
 - Model based
 - Measures

The bad of pmf : Model-free perturbation attack

The good of pmf : Hardware Trojan detection

Conclusion and perspectives

PHYSICAL FUNCTION : INTUITION

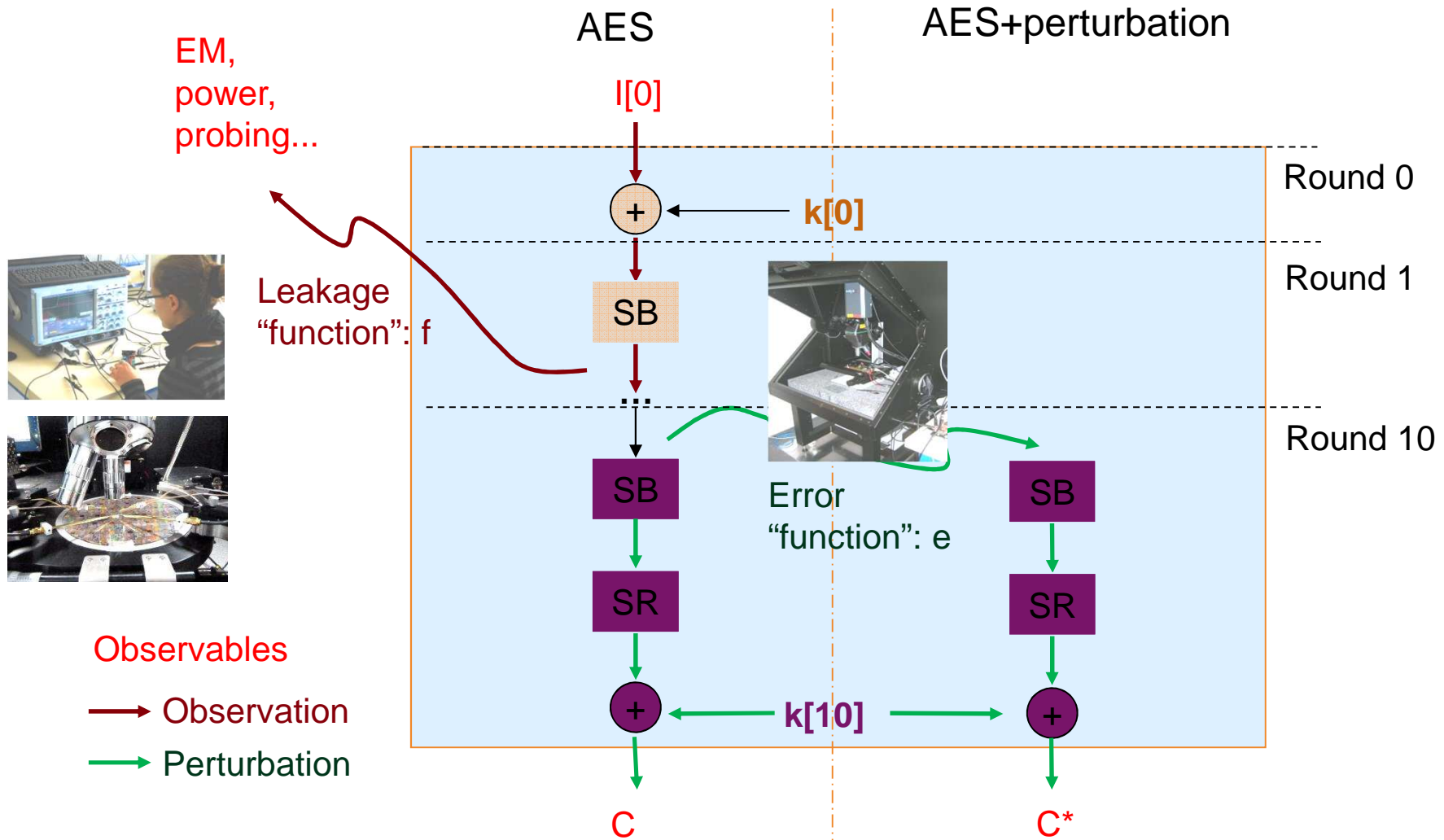

No analytical expression of physical functions

Leakage function: DATA → MEASURE

Example 1: power measurement

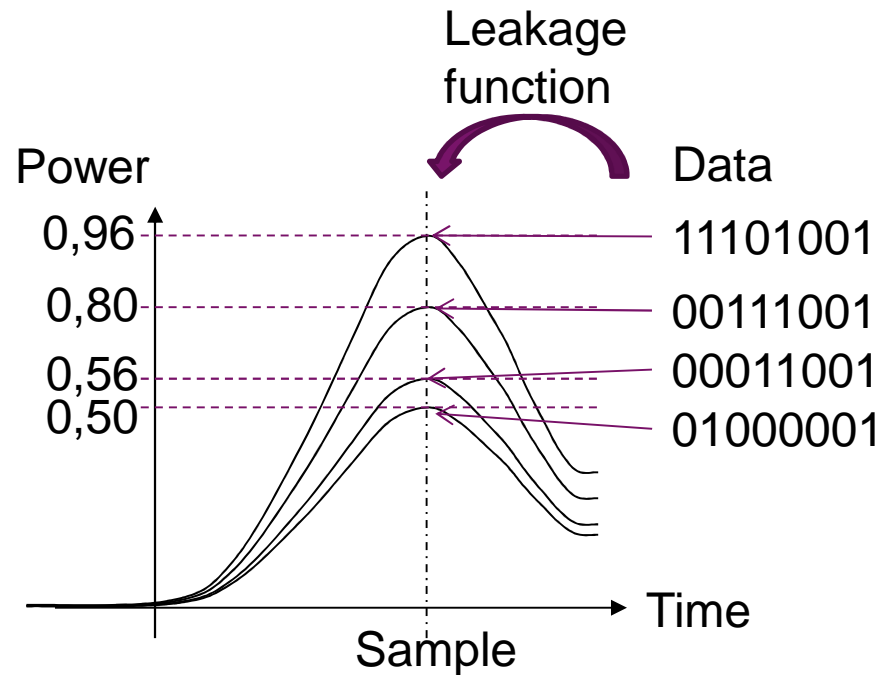

DATA = 1 octet
 MEASURE = Output of the acquisition chain (power probe+ampli+oscilloscope) at one instant = power

$$\{0 ; 2^M - 1\} \rightarrow \{0 ; 2^N - 1\}$$

M=# of bits of the data
 N=vertical resolution of the oscilloscope

Leakage function: DATA → MEASURE

Example 2: micro-probing

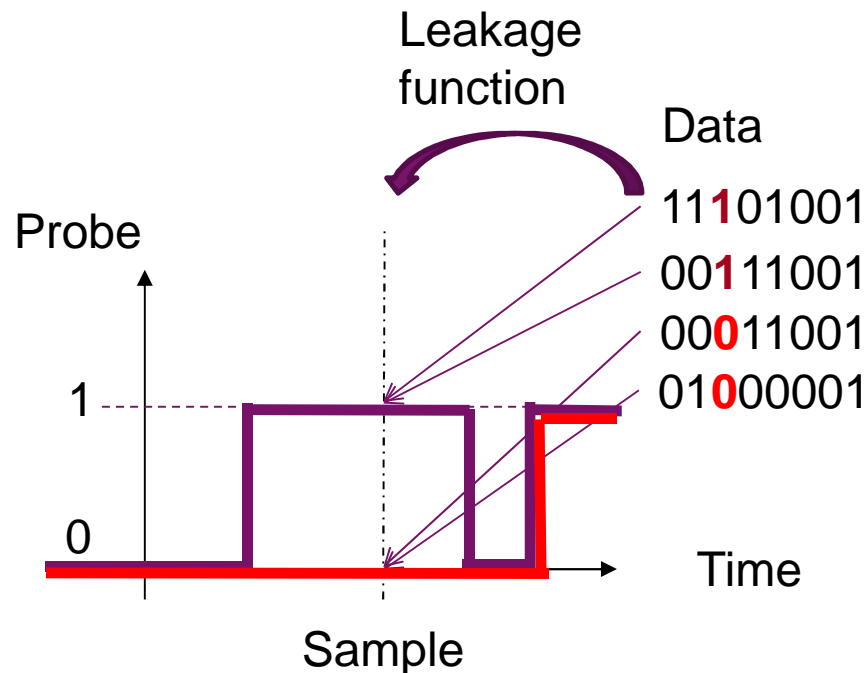

DATA = 1 octet
MEASURE = Output of the acquisition chain (micro-probe+ampli+oscilloscope) at one instant = « Probe »

$$\{0 ; 2^M-1\} \rightarrow \{0;1\}$$

M=# of bits of the data

PHYSICAL FUNCTION : MATH DEFINITION

Error function : DATA → DATA

Example: laser bench

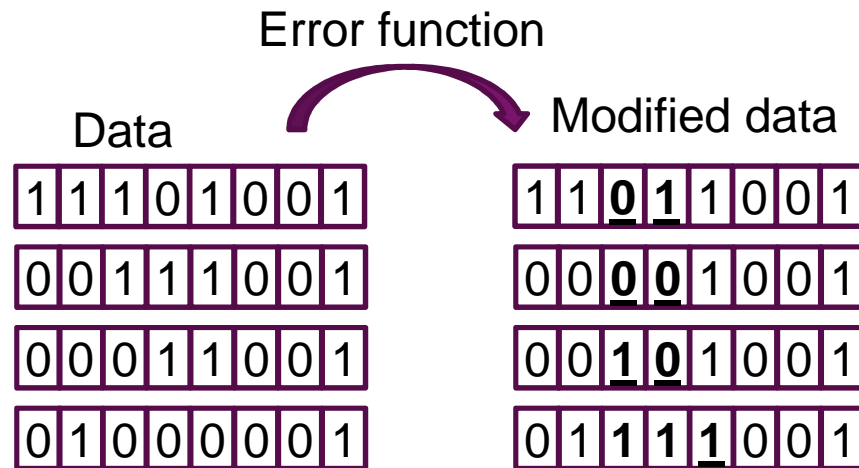
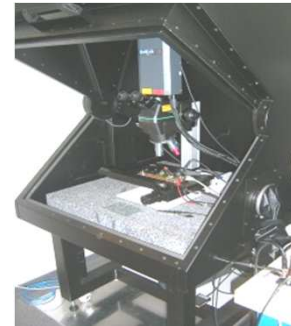

DATA = 1 octet
 DATA = DATA modified by the perturbation mean = 1 octet (of hidden data)

$$\{0 ; 2^M-1\} \rightarrow \{0 ; 2^M-1\}$$

M=# of bits of the data

PHYSICAL FUNCTION : LIMITS OF THE MATH DEFINITION

➔ Classical math definition : linked with models used to perform model based attacks (DPA, DFA, DBA, FSA, etc.)

➔ Limitation : definition has to take NOISE into account

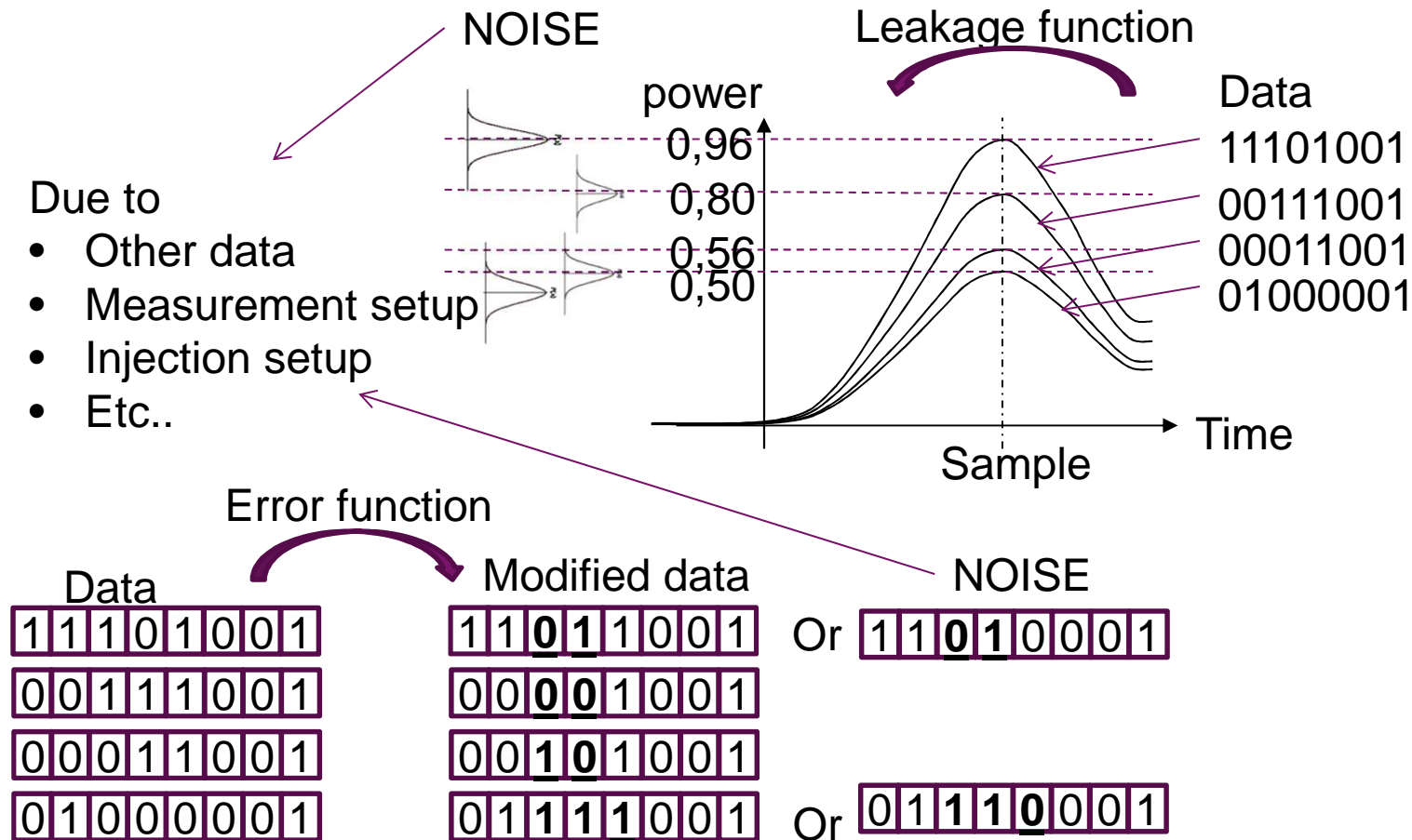

Our proposal :

« Noisy » physical function
=
Joint probability mass function (pmf)

Example 1:

DATA: $D \rightarrow R$ and

MEASURE: $M \rightarrow R$

DATA and MEASURE are considered as two discrete random variables with sample spaces

$D = \{0 ; 2^M - 1\}$ and

$M = \{0 ; 2^N - 1\}$

The joint pmf of the discrete variables DATA*MEASURE is

$f_{\text{DATA*MEASURE}}: R^2 \rightarrow [0;1]$ defined such that

$f_{\text{DATA*MEASURE}}(x,y) = \Pr(\text{DATA}=x, \text{MEASURE}=y)$ whatever x and $y \in R$

EXAMPLES OF PMF: MODEL-BASED LEAKAGE FUNCTION

Leakage function: $\text{Power}(x) = \text{Gauss}(10 \cdot \text{HW}(x), 4)$ with $x \in \{0; 2^8-1\}$

Associated pmf:

\uparrow Mean \uparrow Standard deviation
 Mean Standard deviation

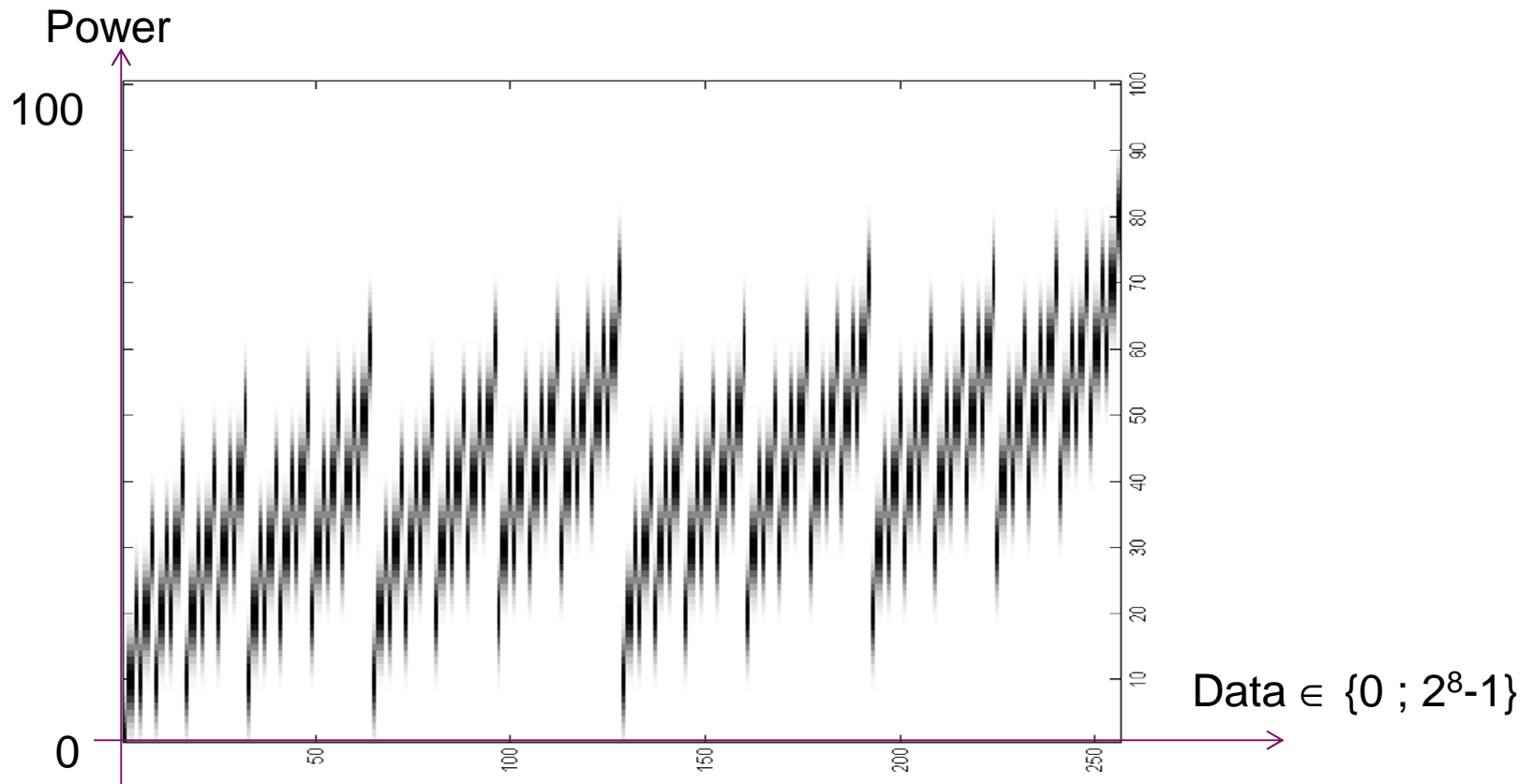

EXAMPLES OF PMF: MEASURE OF LEAKAGE FUNCTION

- ➔ 32-bit microcontroller evaluation board (without countermeasure)
- ➔ Software implementation of the AES-128
- ➔ Oscilloscope Tektronix DPO 7104 (1 GHz)
- ➔ Plain texts (known) : $XX\ 00\ 00\ 00\ 00\ 00\ 00\ 00$ ($XX \in [0:255]$)
- ➔ Key (known) : $43\ 00\ 00\ \dots\ 00\ 00$
- ➔ Measure = power consumption during round 1
- ➔ Data = output of Sbox 1

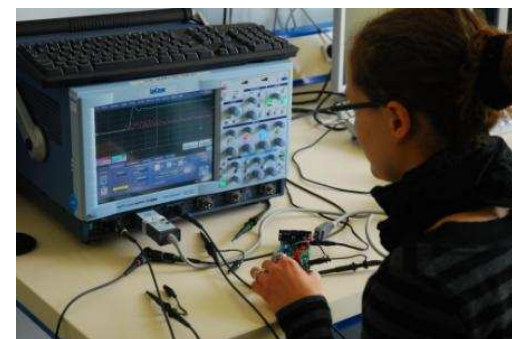

EXAMPLES OF PMF: MEASURE OF LEAKAGE FUNCTION

Measured pmf on a 32 bit microcontroller (S Box1) :

Power

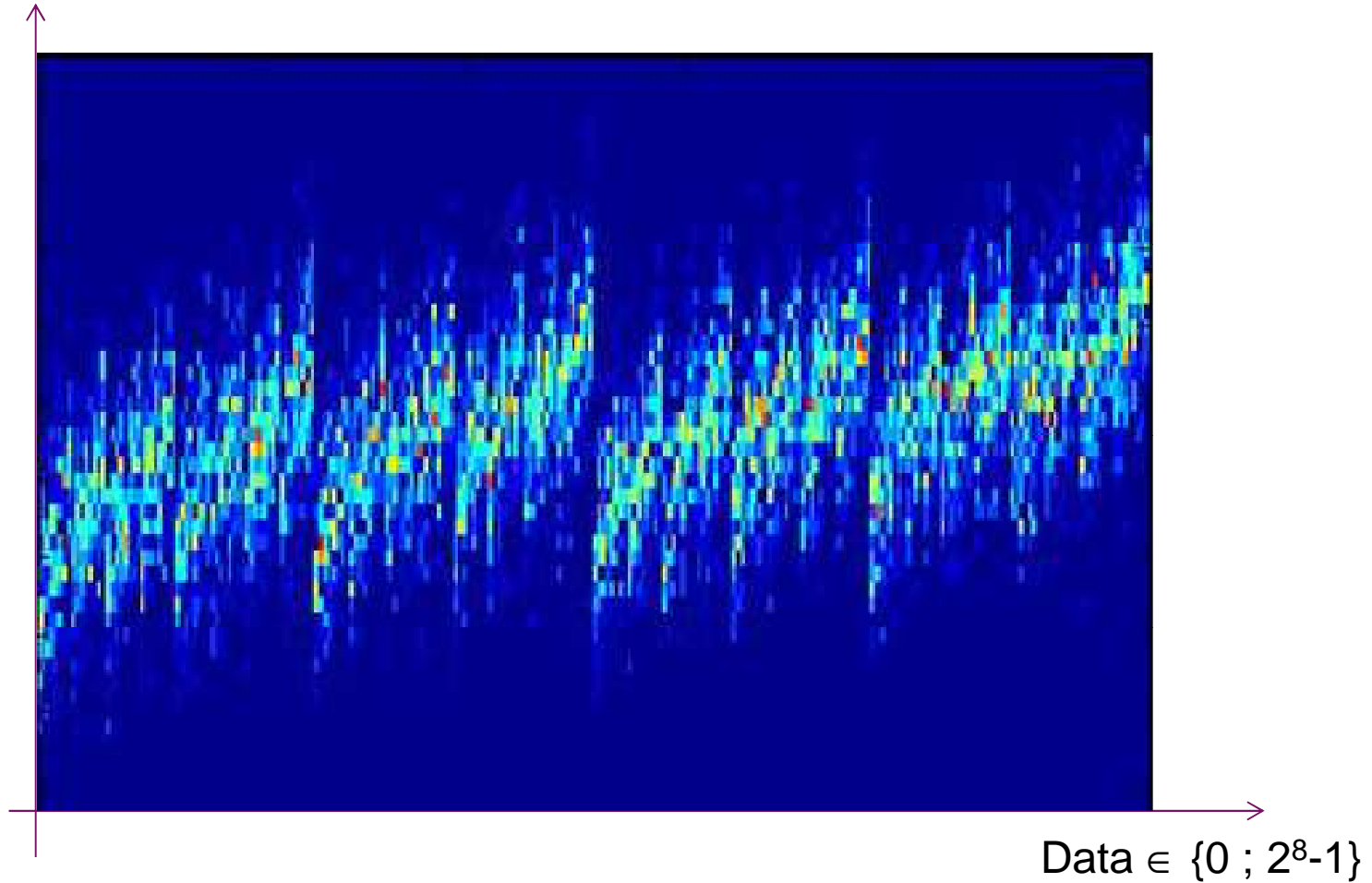

EXAMPLES OF PMF: MEASURE OF LEAKAGE FUNCTION

Start of round

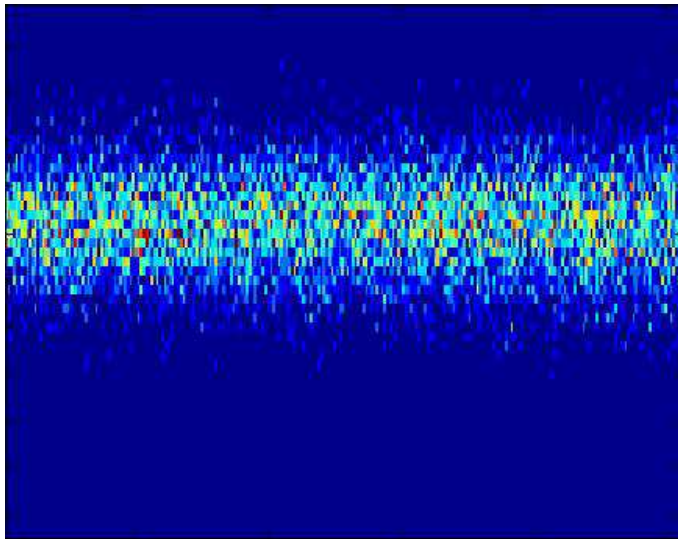

« Start of middle round »

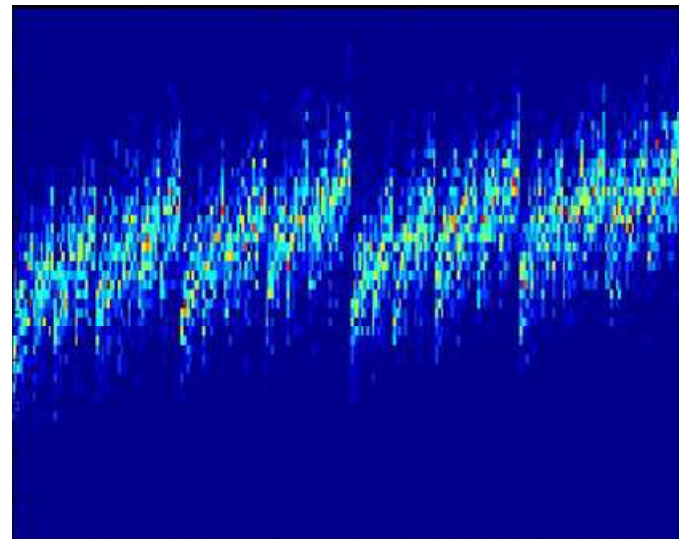

« End of middle round »

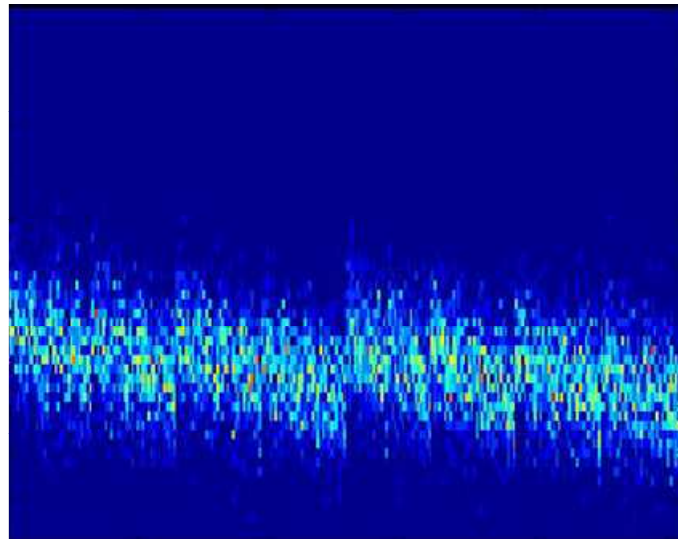

End of round

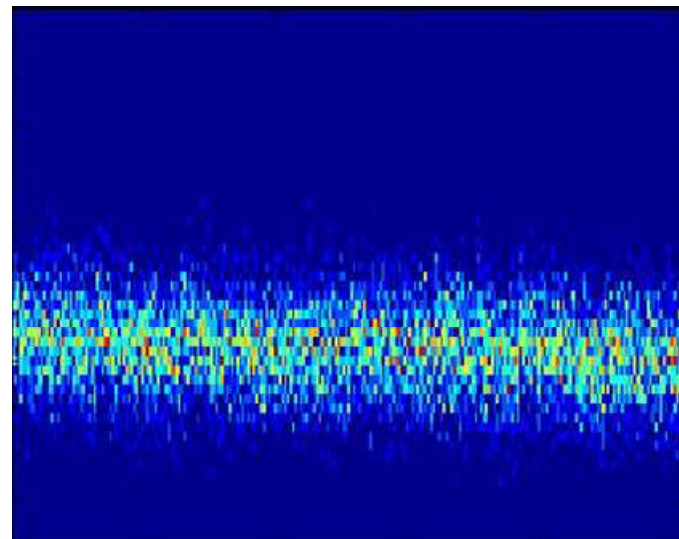

Impact of sample instant

EXAMPLES OF PMF: MODEL-BASED ERROR FUNCTION

Error function: Modified_Data(x) = $x + e_i$ with $x \in \{0 ; 2^8-1\}$ and $e_i = 2^i$ with $p(e_i) = 1/8$ and $i \in \{0,7\}$ i.e « random monobit fault »

Associated pmf

Modified Data $\in \{0 ; 2^M-1\}$

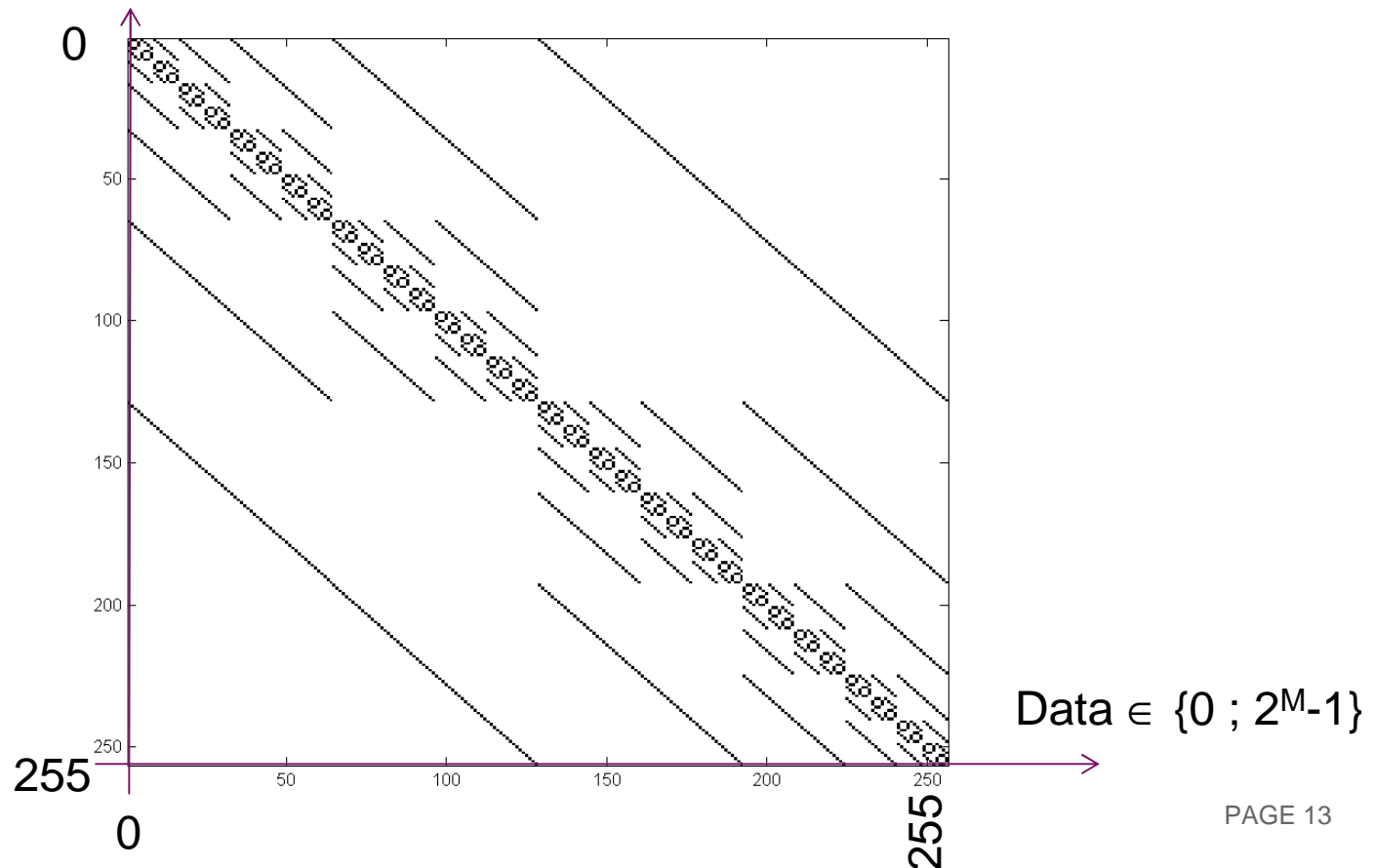

EXAMPLES OF PMF: MEASURE OF ERROR FUNCTION

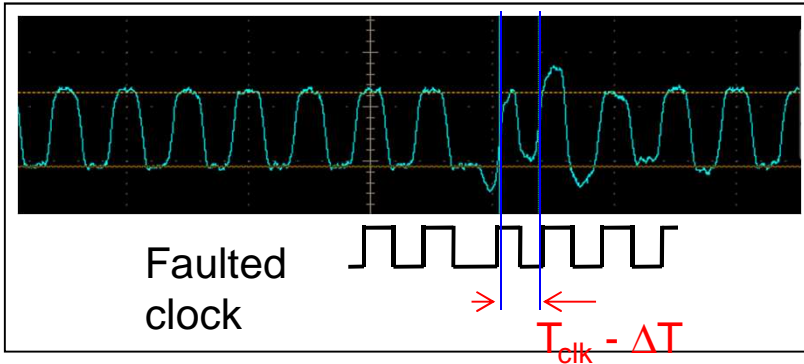

Fault injection principle :

- reduction of one period of the clock (ΔT) ,
- fault injection by clock set-up time

Characteristics of clk generator :

- resolution of ΔT : ~ 35 ps à 100 MHz,
- low cost platform (FPGA Xilinx),
- easy set-up.

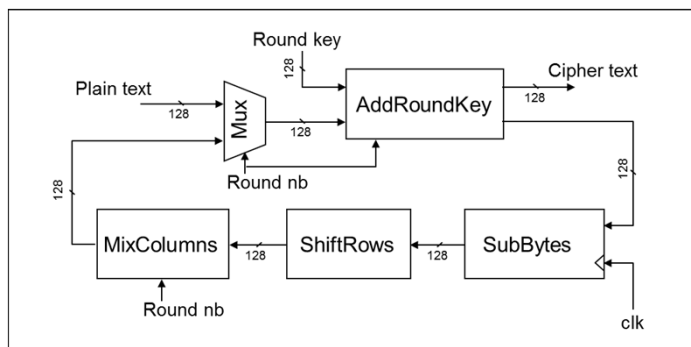
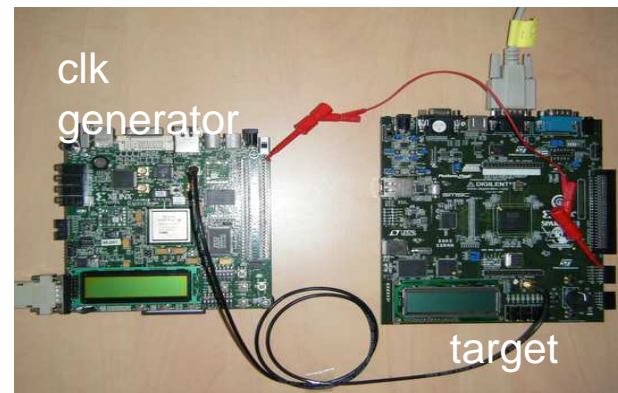

Target

- AES-128 on FPGA (virtex 3 board)
- Fault during the computation of round 9, i.e fault on round[10].start
- Δt from 50 to 130 (*35ps) by step of 1

EXAMPLES OF PMF: MEASURE OF ERROR FUNCTION

Modified Data $\in \{0 ; 2^M-1\}$

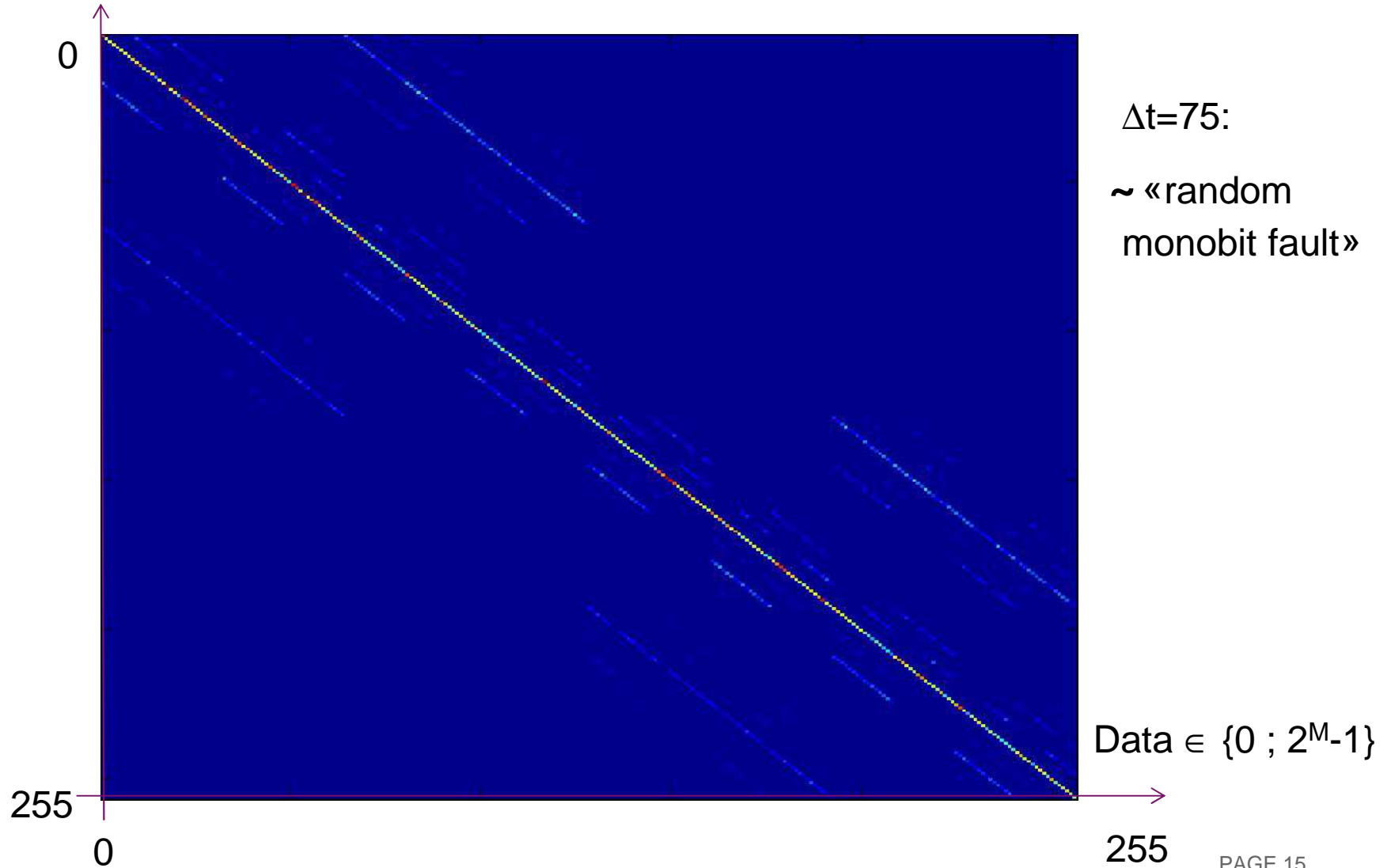

EXAMPLES OF PMF: MEASURE OF ERROR FUNCTION

Octet 13

$\Delta t=50$:
No fault

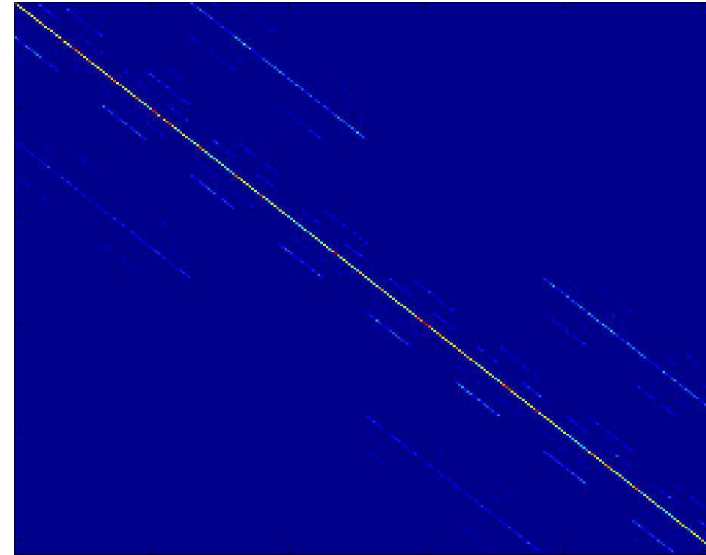
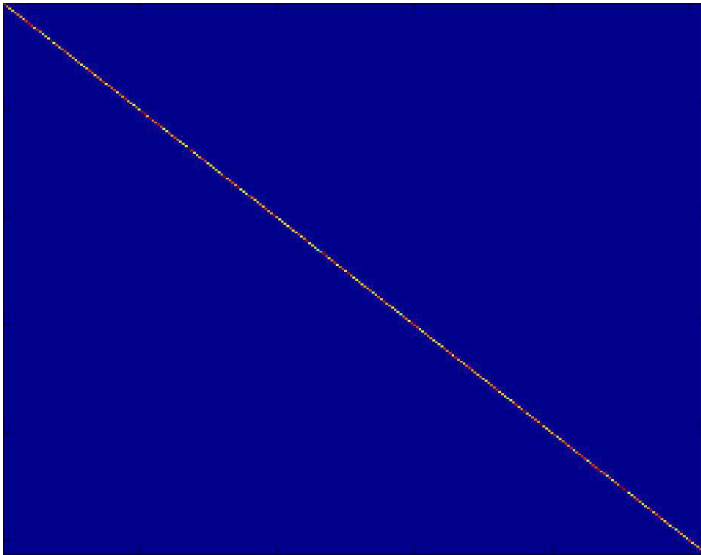

$\Delta t=75$:
~ random-
monobit

$\Delta t=90$
« strange »

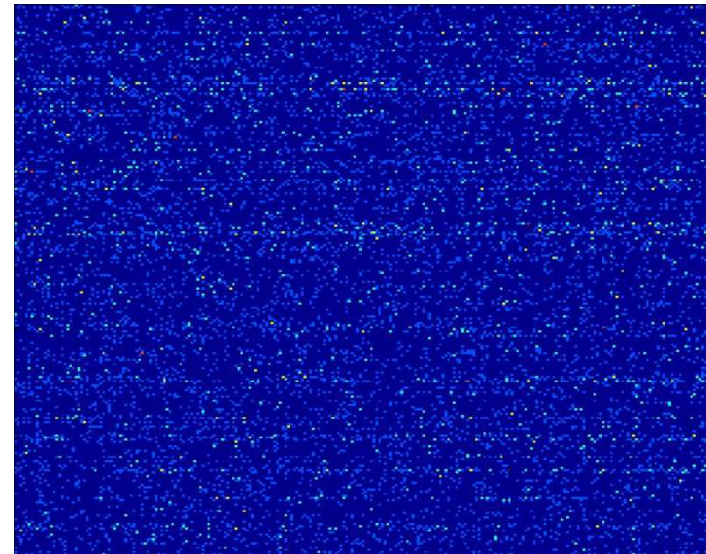
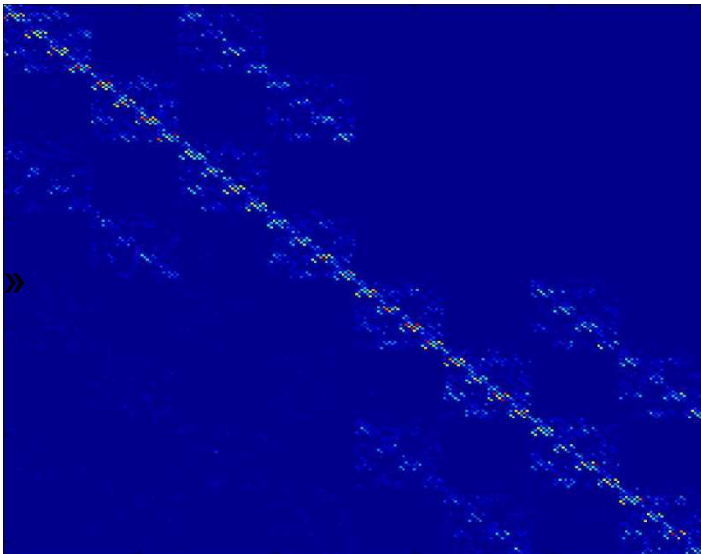

$\Delta t=130$
random

THE BAD OF PHYSICAL FUNCTION: ATTACK

For all hypothesis K on $k[10]$

- Compute $\text{round}[10].\text{start}$ from C and K
- Compute $\text{round}[10].\text{start}^*$ from C^* and K
- Display $\text{pmf}(K)$

Compare the $\text{pmf}(K)$ for all K

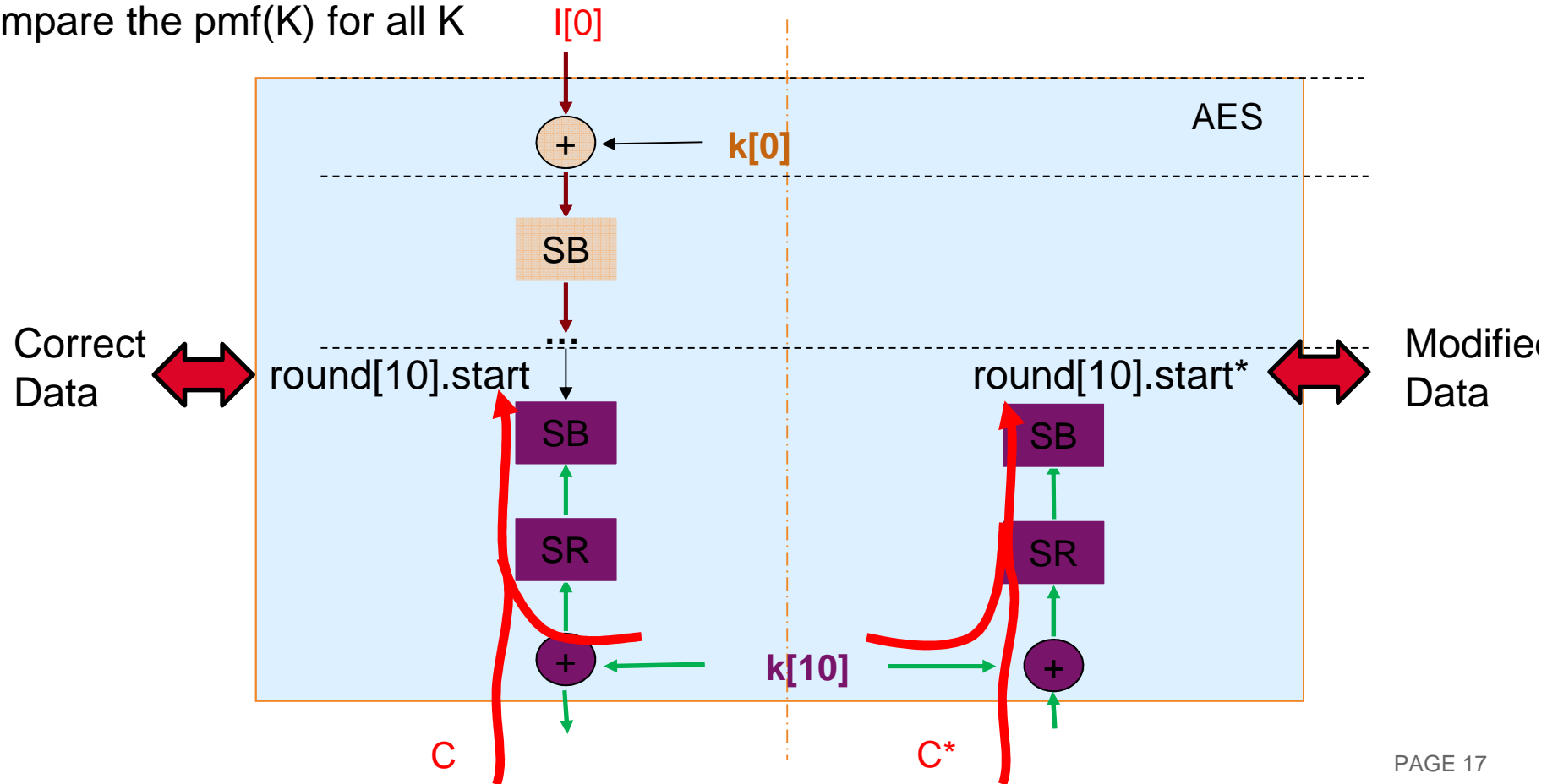

THE BAD OF PHYSICAL FUNCTION: ATTACK DISPLAY STEP

Correct key :

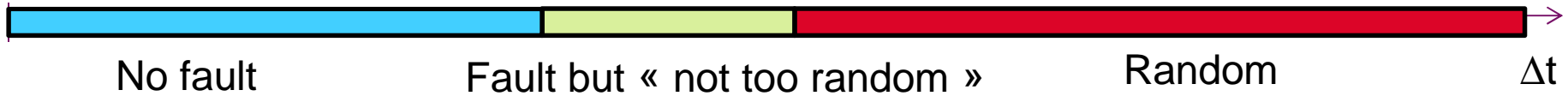
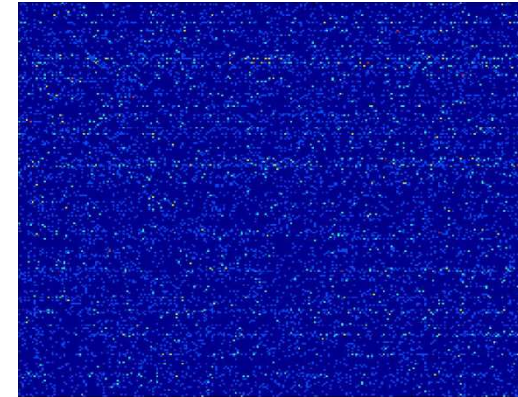
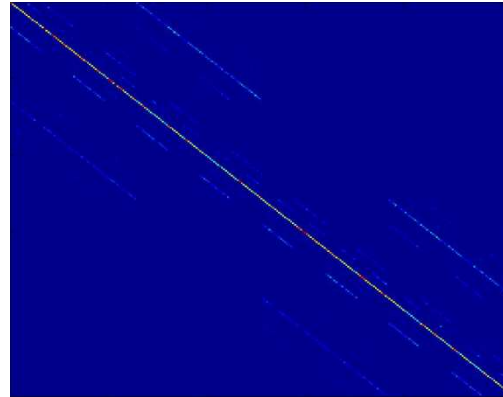
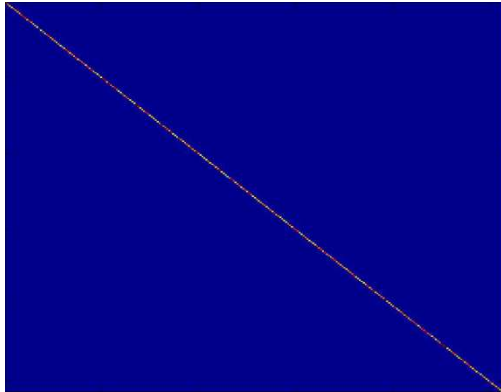

Uncorrect key :

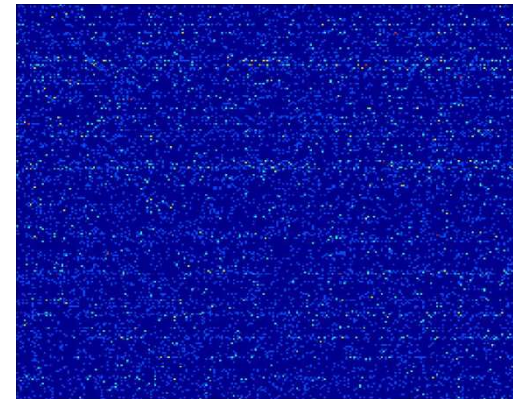
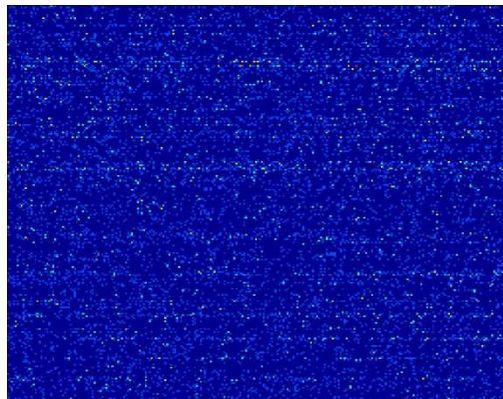
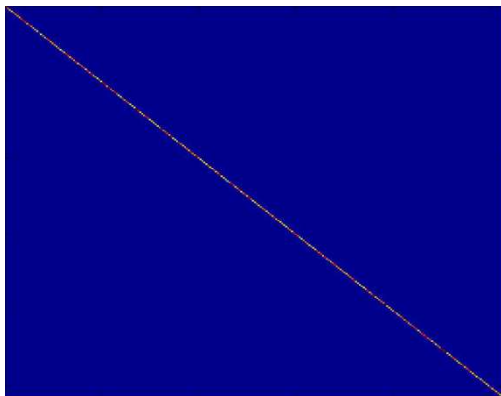

THE BAD OF PHYSICAL FUNCTION: ATTACK COMPARISON STEP

Entropy of the pmf with 100 pairs of correct and uncorrect cipher texts for every key hypothesis:

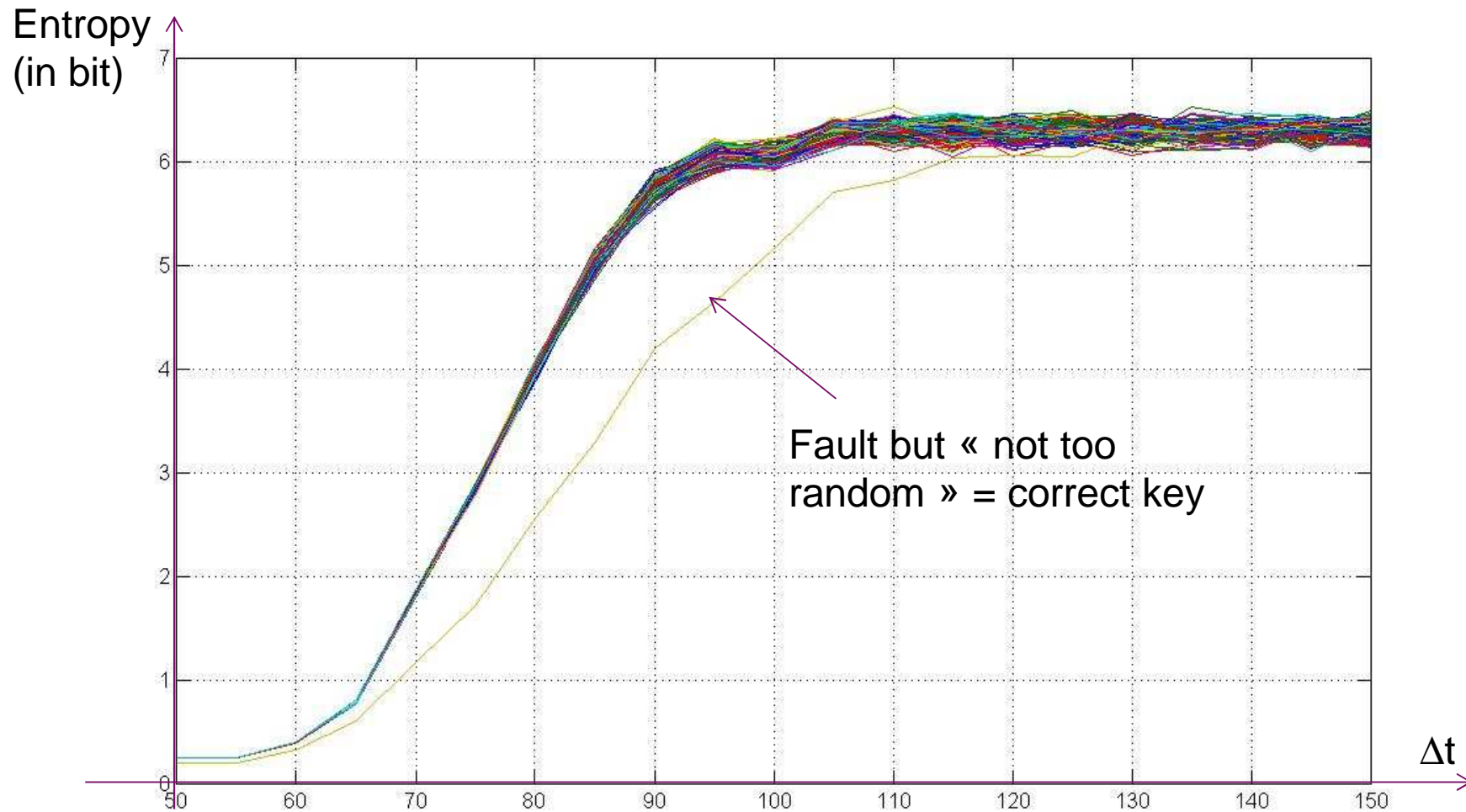

THE GOOD OF PHYSICAL FUNCTION: HW TROJAN DETECTION

HW Trojan: Add « probes » (i.e. additional wires from an internal signal to an I/O) in the design

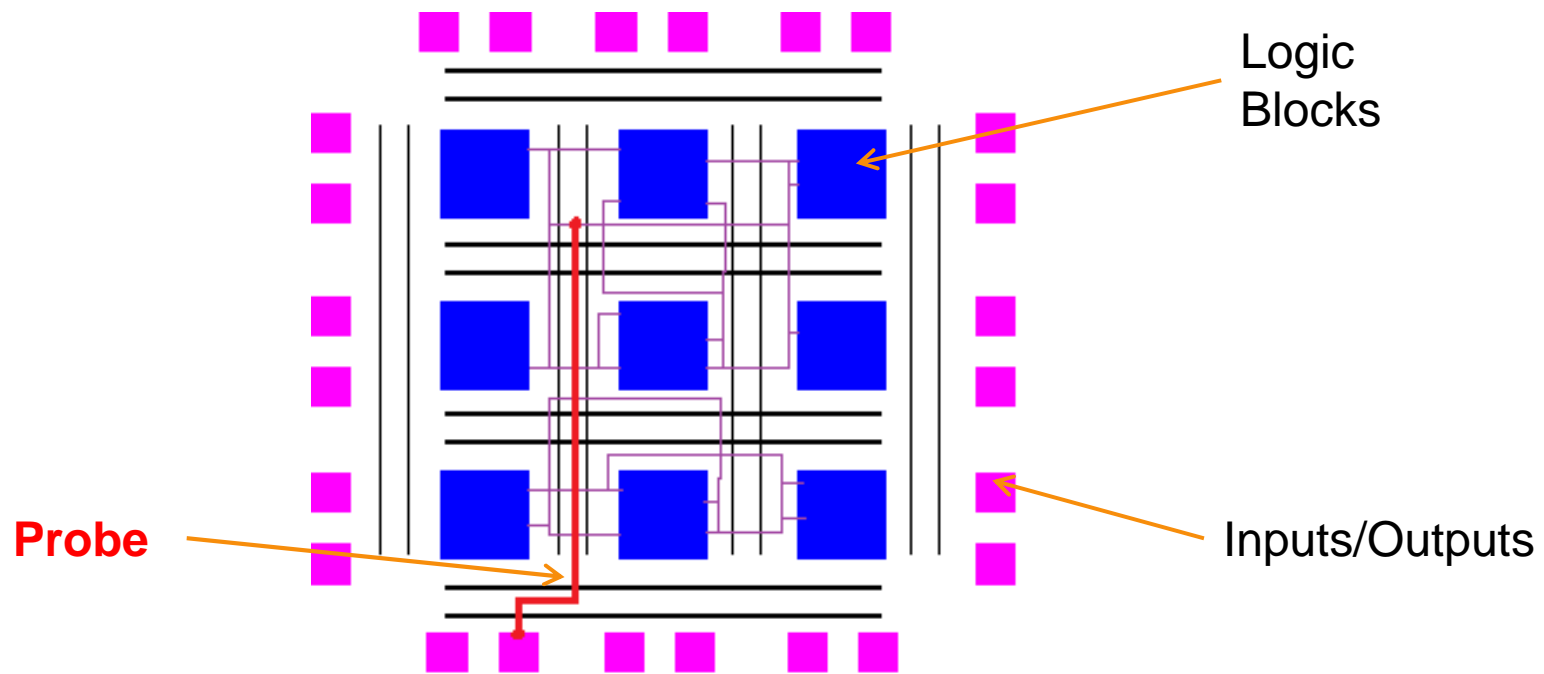

AES-128 on an FPGA

➡ Fundamental hypothesis: the HW Trojan modifies the PMF

THE GOOD OF PHYSICAL FUNCTIONS: HW TROJAN DETECTION

Measure pmf for circuit without (pmf1) and with Trojan (pmf2) and compute pmf1-pmf2

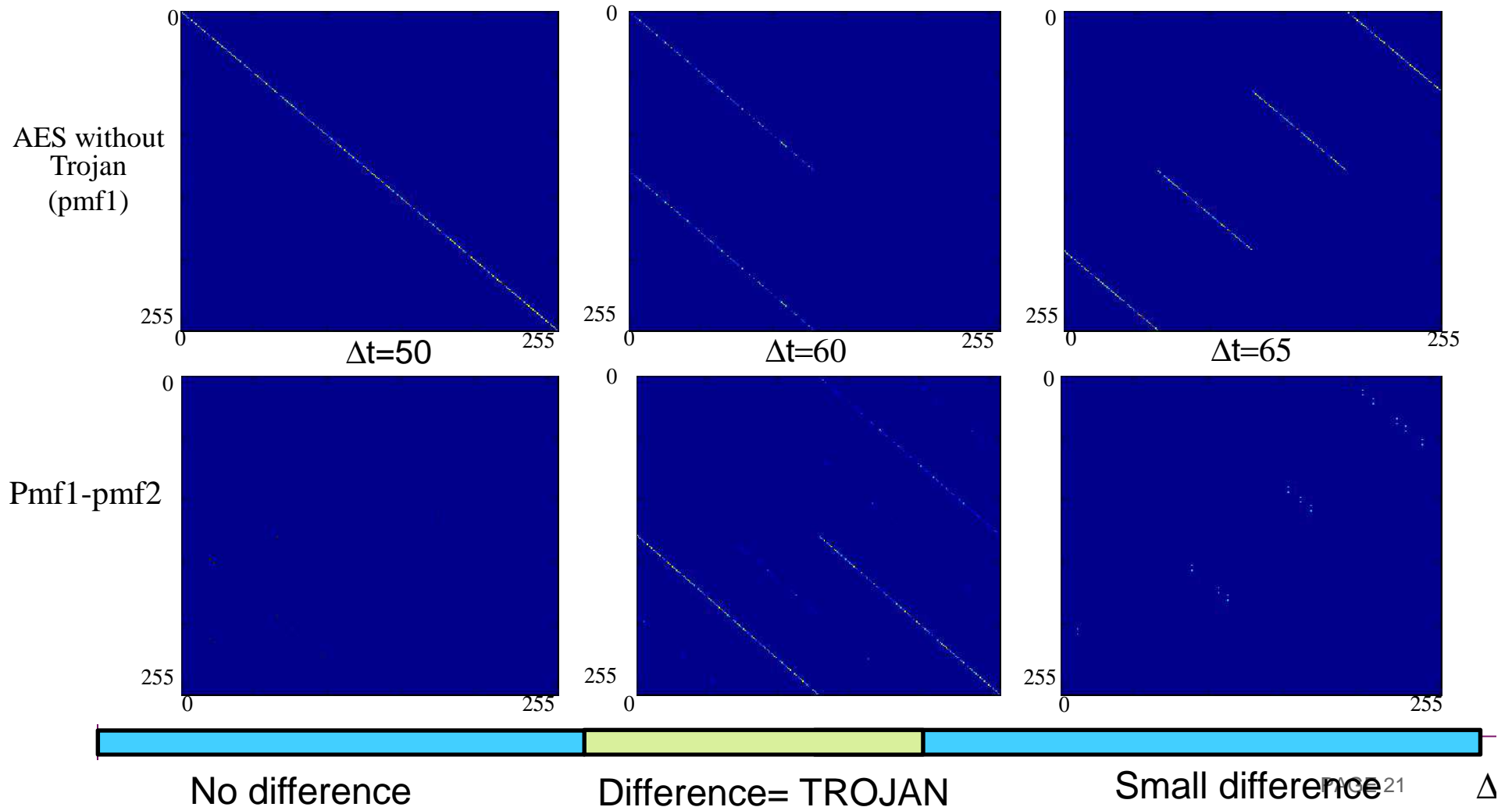

Conclusion

- Proposal of a definition of « physical functions » : pmf
- Link with “classical” models and measurements
- Examples of the use of such a definition
 - Model-free attack with error pmf
 - Detection of HW Trojan with error pmf

Perspectives

- Model-free attack with leakage pmf
- Detection of HW Trojan with error pmf
- Combination of error and leakage pmf

Thanks to Driss Aboukassimi, Ronan Lashermes and Amine Dehbaoui for their help on this work.

Commissariat à l'énergie atomique et aux énergies alternatives
Centre de Saclay | 91191 Gif-sur-Yvette Cedex

Etablissement public à caractère industriel et commercial | R.C.S Paris B 775 685 019

DRT
Institut CEA Tech en Région
Département PACA
Laboratoire SAS