



HAL
open science

First report from an advanced radiological inventory for a spent fuel reprocessing plant

Philippe Girones, Boisset Laurence.Boisset@cea.Fr Laurence, Ducros Christian

► To cite this version:

Philippe Girones, Boisset Laurence.Boisset@cea.Fr Laurence, Ducros Christian. First report from an advanced radiological inventory for a spent fuel reprocessing plant. 2013. cea-00849056

HAL Id: cea-00849056

<https://cea.hal.science/cea-00849056>

Preprint submitted on 30 Jul 2013

HAL is a multi-disciplinary open access archive for the deposit and dissemination of scientific research documents, whether they are published or not. The documents may come from teaching and research institutions in France or abroad, or from public or private research centers.

L'archive ouverte pluridisciplinaire **HAL**, est destinée au dépôt et à la diffusion de documents scientifiques de niveau recherche, publiés ou non, émanant des établissements d'enseignement et de recherche français ou étrangers, des laboratoires publics ou privés.

First report from an advanced radiological inventory for a spent fuel reprocessing plant

Philippe GIRONES (CEA/DPAD) - Laurence BOISSET (CEA/DPAD) - Christian DUCROS (CEA/DEIM)

Main Author's Contact: CEA Centre de Marcoule, bât 222-DPAD, BP 17171, 30207 Bagnols sur Cèze Cedex, France, philippe.girones@cea.fr

INTRODUCTION

With the development of the dismantling industry in a context of ever-stricter requirements for risk mastery techniques, strengthened means of **radiological monitoring** are sought. For obvious safety reasons it is, for example, impossible to pilot a dismantling worksite without a good knowledge of the quality and the level of source terms.

Source term control is constantly improving throughout the life cycle of nuclear facilities, particularly thanks to new requirements in the dismantling industry. Scenario preparation and nuclear waste management at the factory level, strictly governed by safety rules, provide fertile ground for methodological or technical innovations. This means new combinations of data or the development of special detectors to locate or characterise radioactive sources in hostile environments, and enhanced means for detector positioning, in other words robots.

This paper's objective is to illustrate the logic of these developments as implemented for the characterisation of a source term in a pilot reprocessing facility on the CEA's Marcoule site.

SPECIAL FEATURES OF THE FACILITY

Commissioned at the end of 1962, the Marcoule Pilot Workshop, or "Atelier Pilote de Marcoule" (called APM hereafter) was built in order to confirm, at the industrial pilot scale, that the irradiated fuel reprocessing processes developed in laboratories could indeed function well. With over twenty shielded cells, this technological R&D tool enabled checking and qualification for processes and equipment retained or proposed for the AREVA-La Hague reprocessing plants, including the containment of wastes via vitrification.

APM, whose initial purpose was the fine-tuning and qualification of GNU fuel reprocessing, later carried out a series of reprocessing campaigns applied to various different fuels requiring facility reconfigurations, different adaptations of existing equipment or even new construction (the TOP and TOR lines, then the TOR/UP1 link). From 1974 to 1997, when it underwent final shut-down, the facility treated 36 tonnes of heavy metals from various oxide fuels.

APM therefore includes many special features. It should be remembered that the equipment was

adapted to different fuels, including those from fast breeder reactors, meaning a wide range of types of contamination. Moreover, APM consists of two main buildings, differing both in their nuclear architecture (there were 20 years between their constructions), and in the technologies implemented within. Building 211 was built in 1960 and based on a modular principle. For example, the inner walls of the HL cells are made of dry-mounted blocks. The building was mainly involved in the heart of the reprocessing and treatment processes, i.e. solvent-based extraction operations and fission product solution containment using vitrification. Building 214, the more recent of the two, includes high level activity cells whose concrete walls may be up to 1.30 m thick. Some of them are blind cells. The building houses the front end of the mechanical process (dismantling fast breeder oxide fuel assemblies, shearing, dissolution and clarification).

Following final shut-down in 1997, more or less thorough clean-up operations were carried out. The decision to decontaminate certain pieces of equipment was mainly motivated by the absence, in the short term, of any storage solution for the waste packages to be produced and by the desire to reduce the activity levels of large volumes of future waste material, in order to limit the number of remote handling dismantling operations and enable manual dismantling to take place as quickly as possible. The process lines on the TOR line (mainly in Building 214) in particular were subjected to intensive clean-up in order to lower the classification of a large amount of waste, initially category B (180t). Other lines in Building 211, meanwhile, merely underwent a cursory material removal. Therefore, the buildings were in relatively different initial radiological states.

PROJECT OBJECTIVES

Setting up a dismantling scenario requires the most accurate knowledge possible of the initial source term present in the facility, in order to establish waste management flow-sheets, define dismantling intervention modes, and prepare the associated safety demonstrations.

Given the industrial background described above, which meant a great diversity both in plant structures and in types of spectra present, it was necessary to carry out major phases of document collection and then analysis. The documentary information was entered in a special data base

Ref: _____

developed by the CEA, called IDEA. This data base groups the historical information for each cell or room (initial function, any possible reconfigurations, radiological events, etc.), a physical description (geometry, description and location of equipment), and its operational procedures, as well as photos.

The implementation of the data base content was oriented in order to have an inventory of the special points and manage the best way to carry out their radiological characterisation.

These special points were listed based on technical "a priori" assumptions: there are zones or process equipment which, given their operational functions, significantly concentrate contamination. For example, in APM the dissolver in Cell 25 or Tank 68.01 which concentrated fission product solutions are special points, which "a priori" are likely to give atypical contamination values. In general, during their operational period these zones did not have the equipment which would have given the characterisations now necessary for their dismantling.

The characterisation of these points enabled two concerns to be covered: safety (radiation protection, sub-criticality) and waste management (scenario). Each special point was listed in a characterisation plan which included the industrial environment (the access) and which enabled the application of a methodological approach in preparing the dismantling scenario, explained hereafter.

METHODOLOGICAL APPROACH

As previously mentioned, to carry out the studies and write the clean-up and dismantling scenarios, it was necessary to understand and control the risk concentration points or limitations, and to have a mapping or overall view of those limitations. Therefore, from the studies to the actual industrial dismantling operation, the optimisation of the act of transforming a plant into waste packages is a minimising function (see equation 1) of the terms which impose such constraints.

$$f(t) = \min\{Gy, Bq, (n, f)\} \quad (1)$$

Where:

t: time (project: milestones)

Bq: source of contamination which imposes the use of PPE,

Gy: term in dose rate, the consequence of an accumulation of radioactive sources (gamma, neutron),

(n,f): term which groups the nuclides emitting neutrons by spontaneous fission or by (α , n) phenomena, and the fissile nuclides.

The approach could be reduced to a single term, responsible for all the constraints (dose rate, contamination, and criticality risk): the activity expressed in Bq. This is the foundation stone when writing a scenario, as it is the base which decides the PPE and the intervention time or if human access to the worksite should be forbidden, indicates the waste management routes, and enables the declassification of nuclear zones (nuclear site release). It is also a means of controlling sub-criticality. Nevertheless, common practice has been to separate operational activities depending on the three risks, contamination, irradiation and criticality, as the protection or mastery modalities are different. Thus radioactivity is used to assess the type of PPE or, in the case of high level activity cells, the dose rate, via a calculation code.

By measuring the dose rate, expressed in Gy/h (cartography or mapping), optimisation of the minimisation function means a reduction in the time separating the remote handling interventions from the manual dismantling operations. The technico-economic interest of this is obvious, given that there is a twenty-fold difference in cost between the two techniques.

Finally, during dismantling the control mode for sub-criticality is mainly based on controlling the mass of fissile matter. This is because the two usual control modes, geometry and moderator, are excluded, as the components are deconstructed and cut up and the packaging process cannot guarantee the moderator content.

Figure 1 hereafter summarises the flow-sheet for reducing these constraints, with a first step consisting of radiological investigation campaigns using automated equipment to characterise the previously-identified special points in order to estimate the source term.

The optimisation process is next based on a simulation [1] which leads to the identification of a deconstruction and clean-up plan. The deconstruction sequences are then simulated using a virtual reality system [2]. The deconstruction plan is carried out using remote handling equipment available to the industrial operator, and finally checked with investigation tools similar to those used in the special point characterisation step. This iterative loop is applied to the worksite until the project's objective state is reached. This optimisation loop uses simulation based on results obtained from characterisation tools. A single referential is simultaneously created and organised around an Information System (IS) [4].

Ref: _____

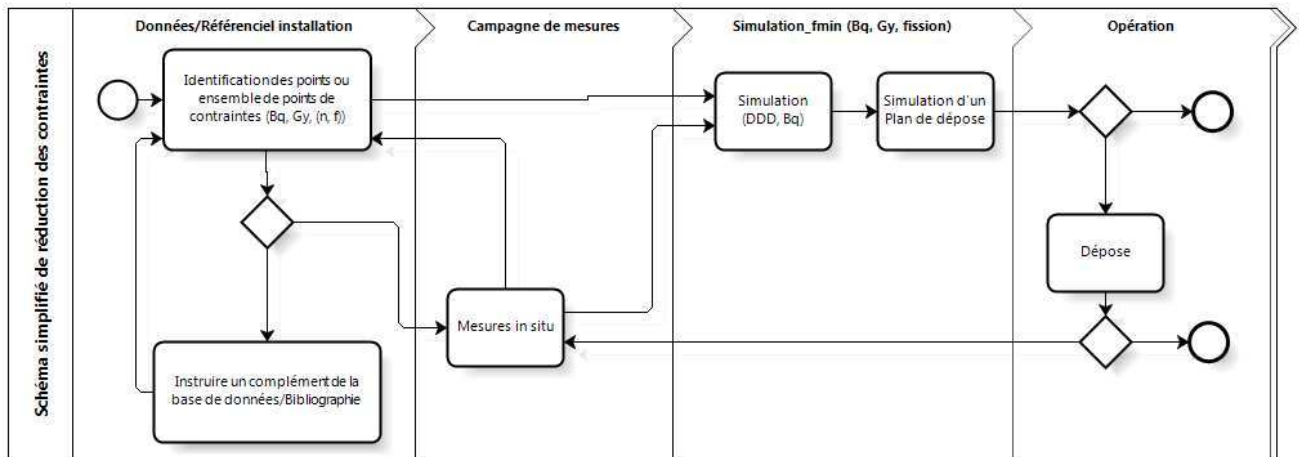

Fig.1: Simplified flow-sheet for minimisation of constraint parameters

To date, this methodological approach has not yet been completely carried out on APM, but the first special point characterisation phase has been accomplished. The means employed, the results acquired and the limits of this investigation phase are discussed hereafter.

techniques giving a radiological view of the sites involved.

- Finally, the technical means to ensure the radiological follow-up of the waste package production line imply ready solutions for production piloting and control, by observing product quality control and the respect of safety rules.

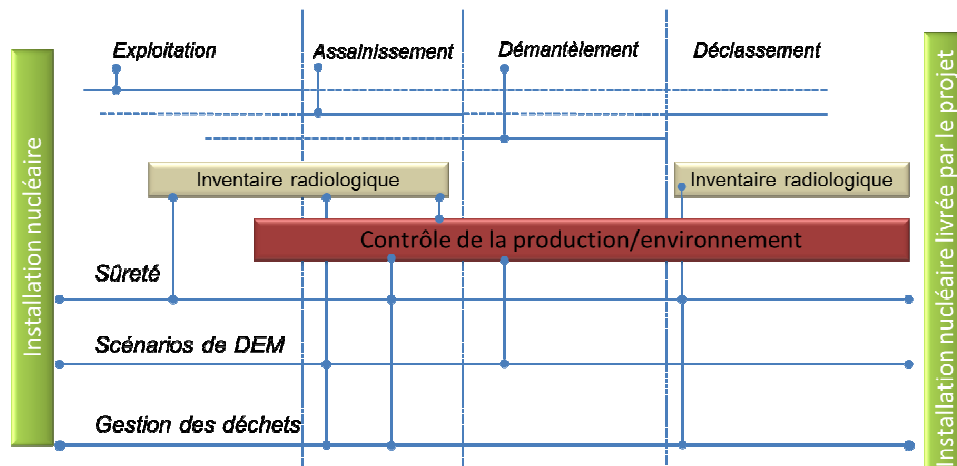

Fig.2: Dismantling Model

MEANS IMPLEMENTED

As shown in Figure 2 above, three phases of dismantling require radiological mastery and follow-up: the initial inventory (the subject of this study), the control of production lines, and the project objective or final state [5].

- Concerning the initial inventory, since 2006 a nuclear facility is required from the outset to have a dismantling design plan. This has obliged the Operators to define a structured management model, in particular in order to improve source term control throughout the plant's lifecycle. This document must simplify the upstream phase of an inventory.

- The downstream radiological inventory is a direct exercise implementing technologies and analysis

Each of these phases represents different expectations, which will need the implementation of particular technical solutions.

Inventory of the in situ measurement equipment implemented

Based on the inventory of non destructive analysis techniques and application domains shown in Table 1, the following analysis techniques were used for the upstream characterisation phase: gamma spectrometry, dose rate measurement, gamma imaging [6, 7].

Ref: _ _ _ _ _

	Analyze. Tech. 1	Analyze. Tech. 2	Analyze. Tech. 3	Analyze. Tech. 4	Analyze. Tech. 5	Analyze. Tech. 6
	Contamination	Dose rate	Absolute gamma spectrometry	Relative gamma spectrometry	Neutron flux	gamma - Alpha imaging
Initial inventory	X	X	X	X		X
Control of production lines	X	X	X	X	X	X
Final state	X		X			

Table 1: Inventory of techniques

The characterisation methods are often a combination of the results from several destructive or non destructive analysis techniques, with different data and calculations [8]. These combinations lead to expressions in the form of an activity level [Bq] or as the identification of radio-elements (Figure 3).

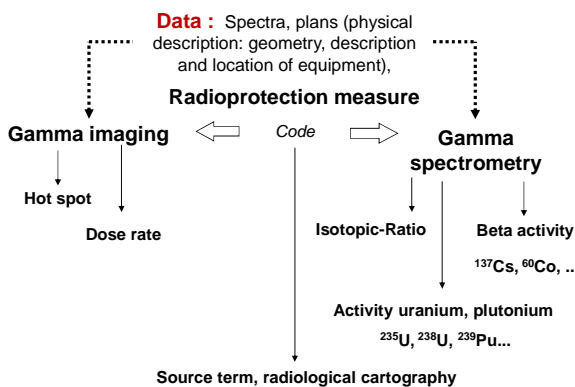

Figure 3: Example of combining analysis methods

Different expressions of results are processed. However, the identification of the radionuclides and the radioactivity are sufficient to meet all the dismantling project’s requirements (Table 2).

	DATA - Units					
Analyze. Tech. 1_ Contamination	Impulsions/s	Bq	Bq/cm²			
Analyze. Tech. 2_ Dose rate	Gy/h	Gy				
Analyze. Tech. 3_ Absolute gamma spectrometry	Radionuclides	Bq	Bq/g	Bq/cm²	Bq/cm³	Gamma flux
Analyze. Tech. 4_ Relative gamma spectrometry	Isotopic-Ratio	U Enrichment	Burn-up			
Analyze. Tech. 5_ C	Mass ²³⁹ Pu	Mass ²³⁸ Pu	Mass ²⁴⁰ Pu			
Analyze. Tech. 6_ gamma - Alpha imaging	Hot spot localization	Gy	Gy/h			

Table 2: Inventory of characterisation techniques

In practice, for upstream characterisations, investigations begin by looking at radiation protection instrumentation data. Dose rate measurements quickly give information about the general level, or enable a fast mapping of the site. Thus the cartography points out the contamination concentration points or zones, and the atmosphere in movement areas. Atmospheric sampling shows the level of labile contamination. Operational conditions are thus defined thanks to these two assessment methods; for example, they enable a fast evaluation of the types of PPE necessary.

In the next step, gamma spectrometry is used to observe the quality of the radio-elements present. The spectra can also be analysed to provide qualitative information if the form of the source and the quality of the screens separating the source from the detector are mastered.

Finally, in the case of complex scenes, or a situation for example where the form of the source is not well understood or in a case where there are numerous sources, the use of a gamma camera can prove to be very useful.

When interpreting physical data, on the margin of instrumentation, calculation codes complete the term evaluation approach. There are two ways to use these. The first enables the yield functions to be traced, particularly for gamma spectrometry [9], while the second gives an interpretation of the radiological consequences of a set of sources, in a single room for example [10].

Performances of the acquisition systems

The choice of a system [group of radiological characterisation techniques] is a process which participates in the assessment of the quantity and quality of radionuclides or more simply, it is a contribution to radiological information gathering: the level of contamination or irradiation is needed. The right choice of techniques is an obvious issue in ensuring the worksites progress well, and cannot be summarised just in the choice of an instrument. It is a system in the sense of being a combination of technological bricks to ensure the acquisition, the processing and then the validation of radiological data, and produces a continuous chain of information throughout the dismantling and clean-up operations. The performances of a radiological characterisation system are based on:

- The standardising techniques,
- The expression of the decision threshold and the detection limit,
- The expression of an associated uncertainty [error, (Figure 4)] or it can also depend on the representativity of the “sampling or component part characterised”.

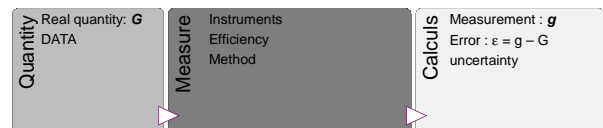

Fig. 4: Process of preparing a transformation model for the raw data into radiological data.

In practice, the request expressed by the project or the nuclear Operator guides the choice of radiological characterization systems. This is in the form of an equation, resulting from a combination of the reference texts (ANDRA storage site specifications, regulations concerning nuclear

Ref: _____

matter transport management, etc.), of the summary explaining the industrial context (feedback from the Operator, measurement environment, etc.) and of the operation's objective: deconstruction of a component, nuclear declassification, or other.

The answer is a technological solution for acquisition, processing and traceability.

Non destructive analysis techniques

Analysis techniques are the result of an acquisition method which includes the development of mechanical systems and of the means of in situ control.

Advanced dose rate measurement

Dose rate measurement is carried out using technical means coming from the radiation protection field. They have the advantage of giving a direct interpretation and do not need heavy equipment, as they include just the detector and a reader box. Also, the equipment can resist irradiation well, for example the IF104 probe from Saphimo [11], an instrument which is guaranteed for an integration of 3000 Gy, and may therefore be set up in a hostile environment for clean-up monitoring [AIE2006].

It is the most commonly-used means of measurement during campaigns in HL cells. The devices are often completed by modular collimators [13] in order to limit the influence of parasite sources and to be able to draw up maps to point out possible special points (fig.5). In certain situations, this type of system is a good alternative to the gamma camera. They do however have the drawback of not including a means of traceability (direct reading) and "absolute" result interpretation is rarely relevant. They are therefore limited to being a good mapping instrument, giving a relative interpretation.

In situ gamma spectrometry

The detectors most compatible with the industrial constraints present in buildings undergoing dismantling are CdZnTe detectors [14]. These devices give an energy response suitable for the radio-elements encountered (<2 Mev). The yield is compatible with the sources' activity levels (> 1 GBq), and their footprint and weight are very small. It is therefore possible to place such detectors on mechanical apparatus in order to set them up facing radioactive sources.

At present, industrial detectors offer probes based on crystals with volumes of between 0.5 mm³ and 1500 mm³. They can obtain good-quality spectra for dose rates of between 1µGy.h⁻¹ and 10 Gy.h⁻¹ (for ¹³⁷Cs or ⁶⁰Co).

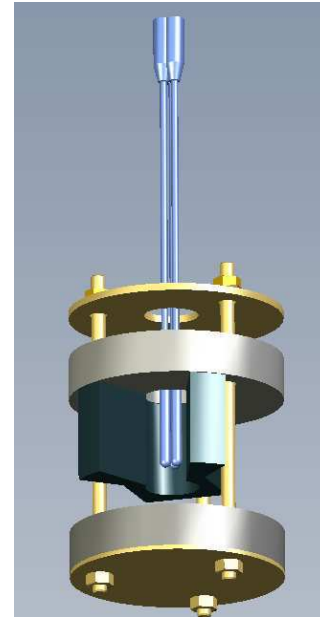

Fig. 5: "camera cheap" [Patent: Fr 2943143 (A1)]

Figure 6 shows the "absolute" yield curves corresponding to different hemispherical polarisation detectors. In these curves, the intrinsic yield is defined as the ratio between the counting rate at a given energy over the fluence rate of that energy (at the centre of the detector).

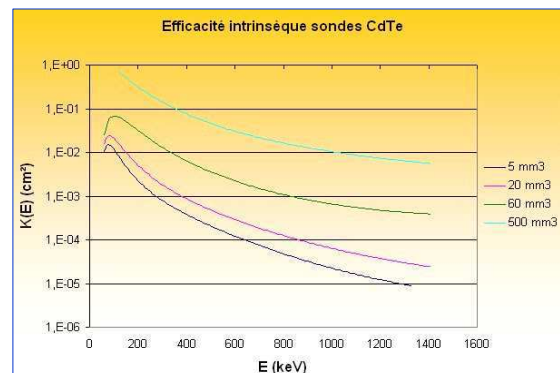

Fig. 6: "Intrinsic" yield curves for different crystal-based CdZnTe probes

The detection efficiency decreases considerably when the energy increases, which can be an issue in our case given the complex spectra.

Gamma spectrometry acquisition lines were set up to determine the ²⁴¹Am/¹³⁷Cs ratio on the components. This type of result is very interesting for our application and has the advantage of detecting in a simple actinide PF mixture (optimisation of the actinide content).

Ref: _____

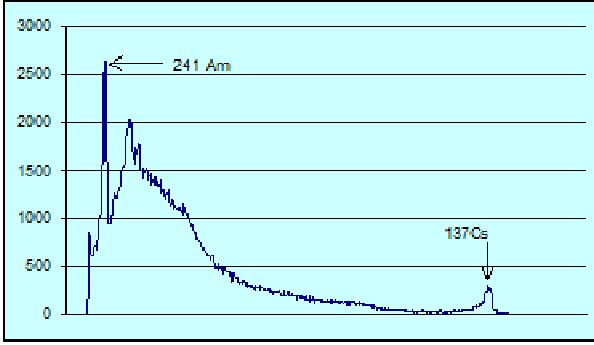

Figure 7: example of 241Am / 137Cs spectrum on a waste drum

The interpretation of spectra requires a yield standard curve to be drawn. The variety of the component geometries imposes a digital standardising technique. Here, the method consists of breaking down the yield into two parts, where the first depends on the detector and translates the capacity from a gamma flux to collect the information, i.e. to draw a total absorption peak. The second term depends on the source, describing the losses of full energy flux on the pathway of the gamma radiation from the emitter nucleus, then through the series of screens which separate it from the entry surface of the detector.

The probe-dependent term was determined experimentally using standard point sources situated at a distance from the detector. The count rate was calculated for each significant peak and compared with the standard flux density estimated at the center of the detector. A set of points was defined in this way, then a curve was plotted versus the energy, representing the “absolute detector efficiency” $K(E)$. The points on the curve were calculated for several discrete energy levels corresponding to different emissions from the standard source:

$$K(E) = \frac{N(E)}{Tc \dot{\phi}(E)} \quad (3)$$

$$\text{With, } \dot{\phi}(E) = \frac{A \Gamma(E)}{4 \pi d^2}$$

where $K(E)$ is the intrinsic detector efficiency at energy E , $N(E)$ is the peak area for energy E , Tc is the spectrum counting time (s), A is the source activity (Bq), $\Gamma(E)$ is the branching coefficient of the gamma transition of energy E , and d is the distance between the source and the centre of the detector (cm).

For a given source, the $K(E)$ function determines the photon flux density at the centre of the detector (2):

When the $K(E)$ function is used as the efficiency curve, the flux density is normalized to the decay of a radio-element emitting at energy E (3):

$$\dot{\phi}^*(E) = \frac{N(E)}{Tc K(E) \Gamma(E)} \quad (4)$$

Where $\dot{\phi}^*(E)$ is expressed in: $\text{cm}^{-2} \cdot \text{s}^{-1}$.

The term dependent on the measurement geometry was calculated using the MERCURE code.

Calculation method

The measurement geometry is described by surfaces whose intersections delimit volumes; each volume is filled with a medium of selectable composition. The radioactive sources are then placed in the volumes. The sources are defined by a mesh that divides them into point-source unit volumes. For each source and for a series of discrete energy levels, we calculated the sum of the events reaching the calculation point without any interaction with the media through which they passed. The computation kernel developed for MERCURE uses the simplified physical model including only straight-line paths (Figure 8).

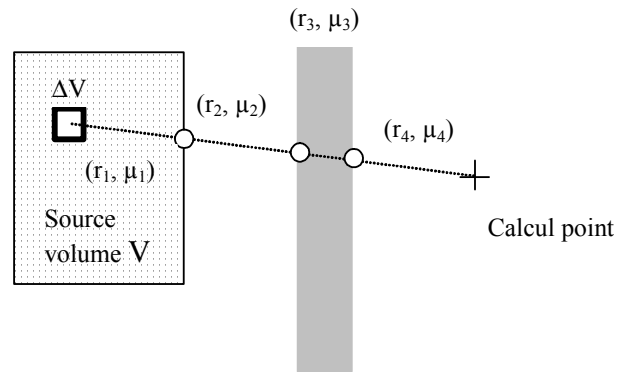

Figure 8: Straight-line transmission model

$$\Delta \dot{\Phi}(E) = \frac{1}{4\pi (\sum r_i)^2} \exp^{-\sum r_i \mu_i(E)} \frac{\Delta V}{V} \quad (5)$$

$$\text{With: } \dot{\Phi}(E) = \sum_V \Delta \dot{\Phi}(E)$$

where $\dot{\Phi}(E)$ is the flux density (cm^{-2}) at the calculation point emitted by the source contained in the element of volume ΔV , r_i is the thickness (cm) of material i traversed by the radiation emitted from the source contained in the element of volume ΔV , $\mu_i(E)$ is the linear attenuation coefficient (cm^{-1}) of medium i , and V is the total source volume (cm^3).

The transfer function, $\dot{\phi}^*(E)$, represents the flux density corresponding to a unit activity (and is thus expressed in cm^{-2}).

The source activity is inferred from the following ratio:

$$A = \frac{\dot{\phi}^*(E)}{\dot{\Phi}(E)}$$

where A is expressed in Bq. This method for plotting the efficiency curve has the advantage of not requiring complex calibration of the detector.

Ref: _____

In addition, the transfer functions are independent of the detector, and can be reused when the probe is replaced. The MERCURE code is also capable of modeling extremely complex geometries, even a complete building such as a nuclear reactor containment building.

$$A = \frac{N(E)}{T_c K(E) \Phi(E) \Gamma_{(E)}}$$

The term for the counting time is negligible. Radioactive constants are specified in data bases with an uncertainty level, which is thus unnecessary to determine. By combining the relative deviations for each variable we can write:

$$\left[\frac{\sigma_A}{A} \right]^2 = \left[\frac{\sigma_{K(E)}}{K(E)} \right]^2 + \left[\frac{\sigma_{\Phi(E)}}{\Phi(E)} \right]^2 + \left[\frac{\sigma_{N(E)}}{N(E)} \right]^2$$

Advanced technologies complete these methods whose main technique is the gamma camera and, more recently, the alpha camera. These instruments are used to locate contamination concentration points and are very useful in deciding on the choice of deconstruction method for the reduction of the source term.

These analysis techniques could not be processed in the context of radiological investigations without technical support. The team must have carriers available for the acquisition phase, and these must also carry out information transport functions (data traceability).

On-board investigation system

The ideal investigation system combines three functions: acquisition, processing, and traceability. With such an ideal instrument in mind, robots have been developed. These technological on-board developments have also been motivated by the need to have simple means available to implement in hostile environments, in order to reduce the radiological constraints in the shortest possible time. To achieve this, the platforms have to carry all the analysis equipment: gamma camera, dose rate measurement, and gamma spectrometry. The objective was reached by using a signal multiplexing technique reducing the tether to a single KX-type cable. Thanks to this, the platforms are able to set up the investigation equipment up to 100 m from the base.



Fig. 9: RICA III robot (gamma camera, dose rate measurement, gamma spectrometry, telemetry)

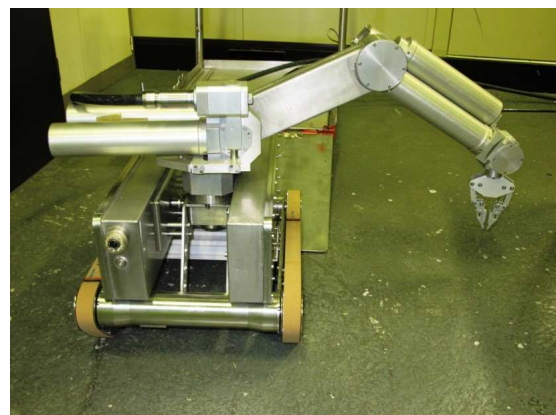

Fig. 10: RICA III robot [15] (gamma camera, dose rate measurement, gamma spectrometry, telemetry)

The first generation of these systems is currently in use, and will no doubt be further developed. Studies are running to set up the coupling of the machines with the company's information systems [16] and other studies involve improving the movement abilities.

RESULTS

Bibliographical analyses have been carried out upstream from the investigation operations. The documents analysed constitute the facility referential, with the safety report as its pivot [4]. Concentration points have been inventoried. They meet the objectives for the reduction of the three terms in the optimisation function (Cf. introductory chapter). The example of the High Level Activity cells and particularly that of the cell which housed fuel dissolution and the first FP and actinide extraction cycles is very instructive.

The objective of the investigations was to describe the physical and radiological environment of a HL cell in order to provide the file with the knowledge necessary to prepare its dismantling.

Ref: _____

The work began with the presentation of the functions and the location of each of the procedure's elements as well as any waste stored in the cell. The history of each element highlighted the events likely to have had an impact on the radiological or physical state of the cell. The results of the radiological and visual inspections include:

- Visual shots (film camera and digital photo camera),
- γ spectrometry and imaging results,
- Dose rate mapping in the thermocouple guide tubes (Geiger Müller detector),
- Analyses carried out on samples.

The total amount of data collected enabled the activity (Bq) contained in certain equipment to be evaluated. The activity assessments were carried out using a method based on the software package called Mercurad.

The first task was to isolate the components where significant activity was concentrated, creating problems for the management of the sub-criticality or of irradiation risks.

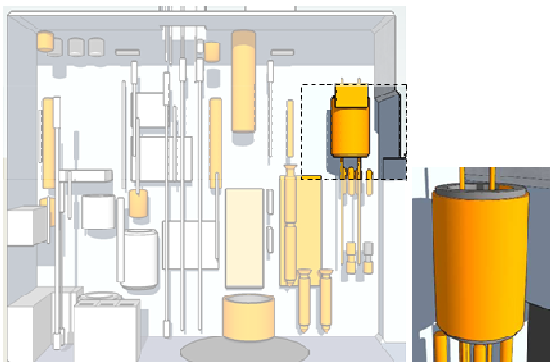

Fig. 11: Example of a component inventory: special point

This inventory is prepared from bibliographical study radiological data: shift records, radiation protection documents, safety report and radiological report notes taken during the final shut-down phase. Based on the investigation plan for special points, core drilling was planned for the cell, in order to enter the instruments necessary for the measurements (acquisitions).

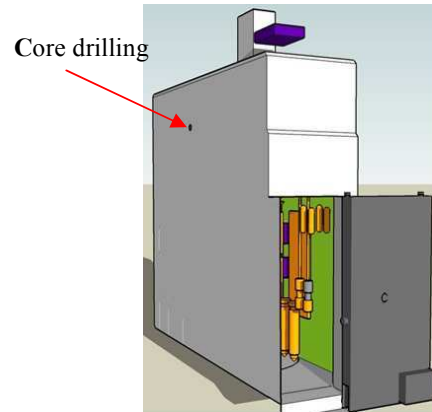

Fig. 12: Example of core drilling
Such access points were at first used to take visual images in order to check the component configurations and the location of possible waste.



Fig. 13: Example of a photo obtained

The images were then analysed to help define the investigation plans, particularly images from the gamma camera shooting campaigns. The choice of solid angles is obviously important, as they are useful in defining the feasibility of acquisitions, given that the scenes contain a large number of sources which parasitize the acquisitions. In other words, each configuration or position of the gamma camera was selected in order to limit the lateral fluence rates [perpendicular to the camera axis].

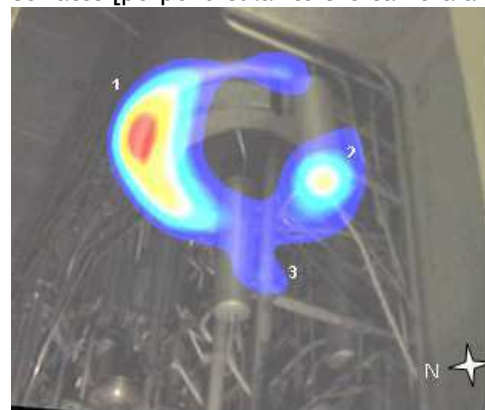

Fig. 14: Example of a gamma image

Ref: _____

The different shots enabled the inventory to be made for concentration points of sources containing significant gamma emitters, like ¹³⁷Cs. Finally these points were entered in a calculation code after gamma spectrometry had been used to check the quality of the gamma fluence rate, i.e. after validating the elements responsible for the dose.

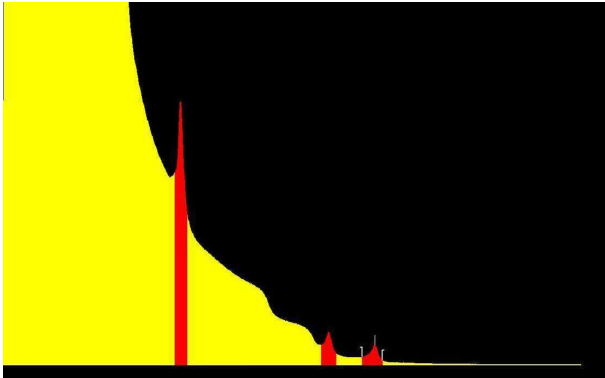

Fig.15: example of a gamma spectrum
The evaluation of the activity based on the *in-situ* dose rate measurements, the location of sources by gamma imaging and confirmation of the energy quality of the fluxes was obtained from a system of equations for which the number of unknowns n is equal to the number of sources modelled. This system is expressed in the following form:

$$[FT_{ij}].[A_i] = [DdD_j]$$

where:

[FT_{ij}] = the squared matrix (n,n) of the transfer functions quantifying the source impact i on the detection point j.

[A_i] = the vector of the activities contained in the sources i

[DdD_j] = the vector of the GAMMA dose rates measured at points j

To obtain a solution, an optimisation method was created. Its objective was to make the source activity values converge (measurement point and calculation point) while minimizing the sum of the squares of the differences between:

- The dose rate value measured on the site,
- The dose rate value obtained with the MERCURAD calculation code.

Here, the objective was determination of the activity values for which the minimum of the function below is obtained:

$$MC = \sum_j \frac{([DdD_j] - \sum_i [FT_{ij}].[A_i])^2}{[DdD_j]^2}$$

The algorithm is iterative and tends towards a solution where the activity values reduce the term MC (Fig. 16). MC is the translation of the minimum gap between the experimental value and the calculated value. Thus for each measurement

point, a calculation point is defined for a group of source configurations.

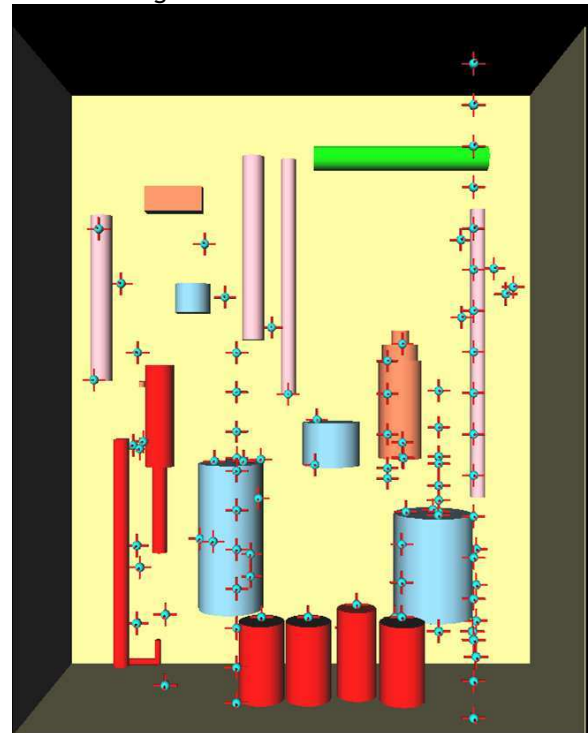

Fig. 16: Example of virtual mapping
The results of this method lead to the expression of the cell's source term, applying a typical spectrum to tracer images. Finally, sampling is carried out to consolidate the typical spectrum for the cell. The method is completed by deploying *in situ* gamma spectrometry. This technique enables, in particular, the confirmation of the value given by the iterative method on the basis of dose rates.

CONCLUSIONS

The objectives of radiological investigations were clearly defined in the early stages of the projects, the methodologies were standardized and the necessary range of tools was available. They therefore enabled confirmation of the special point inventory and the mapping of the source term, essential data for a scenario to be defined.

Feedback has shown that implementing these techniques requires many skills: mechanics, calculations, radiation optics and physics, through to integration in an information system. Moreover, the quality of the result largely depends on the quality of the acquisition, and the know-how necessary must not be underestimated, going beyond just the notions of radiation protection, as otherwise information may be overlooked.

Certain information remains however difficult to obtain, either because it is hidden under an unfavourable signal to noise level (as is the case for actinides in the presence of FP) or because the carriers are not agile enough to move around in the crowded, small spaces which can exist within cells.

Ref: _ _ _ _ _

As well as these first remarks, the industrialisation of investigation technologies still needs to deal with the issue of coupling characterisation systems to the means of calculation and data traceability in an information system.

To conclude, today radiological investigation must not be considered as an occasional operation carried out at different moments during dismantling (e.g. upstream, site release), but must be thought of in an “on line” mode, using autonomous systems able to analyse the radiological consequences of deconstructing actions in real time.

REFERENCES

1. R. Eimecke, S. Anthoni “Ensemble de mesures et d'étude de la contamination des circuits (EMECC)”, 7th International Conference on Radiation Shielding, Bournemouth, Great Britain, September 12 to 16, (1988)
2. Caroline Chabal, Anne Courtadon, Utilisation du logiciel Narveos pour le suivi des rinçages des cuves SPF, France, ATSR, (2010)
3. Caroline Chabal, Virtual Reality Technologies: a Way to Verify Dismantling Operations, ACHI, (2011)
4. P. Girones, prospect of an integrated solution for the radiological inventories of dismantling operations solution for the radiological inventories of dismantling operations, France, to be published.
5. ASN, Méthodologies d'assainissement complet acceptables dans les installations nucléaires de base en France, France, (2010)
6. F. Lamadie, Remote alpha imaging in nuclear installations: new results and prospects, IEEE, (2005)
7. O. Gal, Development of coded-aperture imaging with a compact gamma camera, IEEE, (2004)
8. F. Jallu, The use of non-destructive passive neutron measurement methods in dismantling and radioactive waste characterization, ANIMA, (2011), C. Le Goaller, “Combining Innovative Measurement techniques for Radiological Characterization of process Equipment, ICEMO5, Glasgow, Great Britain, 2005
9. F. Bronson, “Three New Techniques for Radiological Characterization and Dose Estimation”, Decommissioning Challenges, SFEN 2003, Avignon
10. A. Khali, MERCURAD logiciel de simulation 3D pour le calcul de débits de dose, France, SFRP, (2010)
11. <http://www.saphymo.fr/>
12. P. Girones, Methodology for determining the radiological status of a process: Application to decommissioning of fission product storage tanks, Greece, IAEA, (2006)
13. P. Girones, RADIOLOGICAL CHARACTERIZATION DEVICE PROTECTED AGAINST PARASITIC IONIZING RADIATION SOURCES, 20120012749 (2012)
14. P. Fougères et al., “CdTe and Cd_{1-x}Zn_xTe for Nuclear Detectors: Fact and Fiction”, NIM 1999, A428 38-44
15. L. Bruzzone, Review article: locomotion systems for ground mobile robots in unstructured environments, (2012)
16. C. Ducros, VEHICULE D'INSPECTION TELEGUIDE POUR LA LOCALISATION ET LA MESURE D'ACTIVITE DE SOURCES RADIOACTIVES, FR 2925702 (B1), (2009)
17. F. Vermeersch, C. Van Bosstraeten, “Development of the VISIPLAN ALARA planning tool”, Proceeding of the International Conference on Topical issues in Nuclear Radiation and Radioactive Waste Safety, Vienna, Austria, August 31 to September 4, 1998.