



**HAL**  
open science

## **HLA-G\*0105N null allele encodes functional HLA-G isoforms.**

Magali Le Discorde, Caroline Le Danff, Philippe Moreau, Nathalie Rouas-Freiss, Edgardo D Carosella

► **To cite this version:**

Magali Le Discorde, Caroline Le Danff, Philippe Moreau, Nathalie Rouas-Freiss, Edgardo D Carosella. HLA-G\*0105N null allele encodes functional HLA-G isoforms.. *Biology of Reproduction*, 2005, 73 (2), pp.280-8. 10.1095/biolreprod.104.037986 . cea-00268875

**HAL Id: cea-00268875**

**<https://cea.hal.science/cea-00268875>**

Submitted on 1 Apr 2008

**HAL** is a multi-disciplinary open access archive for the deposit and dissemination of scientific research documents, whether they are published or not. The documents may come from teaching and research institutions in France or abroad, or from public or private research centers.

L'archive ouverte pluridisciplinaire **HAL**, est destinée au dépôt et à la diffusion de documents scientifiques de niveau recherche, publiés ou non, émanant des établissements d'enseignement et de recherche français ou étrangers, des laboratoires publics ou privés.

## HLA-G\*0105N Null Allele Encodes Functional HLA-G Isoforms<sup>1</sup>

Magali Le Discorde,<sup>2</sup> Caroline Le Danff, Philippe Moreau, Nathalie Rouas-Freiss, and Edgardo D. Carosella

Service de Recherches en Hémato-Immunologie, CEA-DSV-DRM, Institut d'Hématologie, Hôpital Saint-Louis, Paris 75010, France

### ABSTRACT

Expression of the nonclassical HLA class I antigen, *HLA-G*, is associated with immune tolerance in view of its role in maintaining the fetus in utero, allowing tumor escape, and favoring graft acceptance. Expressed on invasive trophoblast cells, *HLA-G* molecules bind inhibitory receptors on maternal T lymphocytes and NK cells, thereby blocking their cytolytic activities and protecting the fetus from maternal immune system attack. The *HLA-G* gene consists of 15 alleles, including a null allele, *HLA-G\*0105N*. *HLA-G\*0105N* presents a single base deletion, preventing translation of both membrane-bound (*HLA-G1*) and full-length soluble isoforms (*HLA-G5*) as well as of the spliced *HLA-G4* isoform. The identification of healthy subjects homozygous for this *HLA-G* null allele suggests that the *HLA-G\*0105N* allele may generate other *HLA-G* isoforms, such as membrane-bound *HLA-G2* and *-G3* and the soluble *HLA-G6* and *-G7* proteins, which may substitute for *HLA-G1* and *-G5*, thus assuming the immune tolerogenic function of *HLA-G*. To investigate this point, we cloned genomic *HLA-G\*0105N* DNA and transfected it into an HLA-class I-positive human cell line. The results obtained indicated that *HLA-G* proteins were indeed present in *HLA-G\*0105N*-transfected cells and were able to protect against NK cell lysis. These findings emphasize the role of the other *HLA-G* isoforms as immune tolerogenic molecules that may also contribute to maternal tolerance of the semiallogenic fetus as well as tumor escape and other types of allogeneic tissue acceptance.

embryo, gene regulation, immunology, implantation, pregnancy

### INTRODUCTION

Protection of the semiallogenic fetus against maternal immune recognition and attack has been attributed principally to the high and almost unique expression of human leukocyte antigen-G (*HLA-G*) on trophoblast cells at the fetal-maternal interface [1]. The nonclassical *HLA-G* gene is characterized by alternative splicing that yields seven proteins, four membrane bound (*HLA-G1* through *-G4*) and three soluble (*HLA-G5* through *-G7*). Full-length *HLA-G* mRNA encodes the *HLA-G1* protein, which has three extracellular globular domains, one membrane-anchored domain, and one intracytoplasmic domain. Exons 3 and/or 4

may be deleted from the primary transcript, yielding the alternative mRNA *HLA-G2*, *HLA-G3*, and *HLA-G4* forms. In addition, the insertion of introns 2 or 4 may generate soluble isoforms, such as *HLA-G5* (the soluble full-length *HLA-G1* counterpart), *HLA-G6* (the soluble *HLA-G2* counterpart), and *HLA-G7* (the soluble *HLA-G3* counterpart) (reviewed in [2]). The structures of both membrane-bound *HLA-G1* and soluble *HLA-G5* proteins are similar to those of classical class I proteins, consisting of three extracellular domains linked to  $\beta$ 2-microglobulin ( $\beta$ 2m).

Functional assays have demonstrated that both membrane-bound and soluble *HLA-G* proteins are able to inhibit NK cell and antigen-specific T-cell cytotoxicity [3, 4] and the proliferation of allogeneic T cells [5–7]. Moreover, soluble *HLA-G* is able to induce apoptosis of both activated CD8<sup>+</sup> T and NK cells [8, 9].

The identification of these seven *HLA-G* protein isoforms suggested that *HLA-G* provides multiple functions at the immune-privileged sites where they are expressed, such as the fetal-maternal interface, the thymus, and the cornea [10–12]. On the other hand, in the absence of a given *HLA-G* isoform, this redundancy may serve to maintain the immune tolerogenic function provided by one or more of the other *HLA-G* isoforms.

The *HLA-G* gene consists of 15 alleles, including the *HLA-G\*0105N* null allele, which is characterized by a single base-pair deletion in exon 3 [13]. This deletion of a single cytosine at codon 130 results in a gap in the open reading frame, causing a premature stop at either codon 189 (TGA) near the beginning of exon 4, which blocks translation of *HLA-G1* and *-G5*, or codon 297 (TAG) in exon 5, blocking the translation of *HLA-G4*. However, *HLA-G\*0105N* is able to maintain translation of both the membrane-bound *HLA-G2* and *-G3* proteins and the soluble *HLA-G6* and *-G7* proteins, in all of which exon 3, containing the deletion, is removed by alternative splicing (Fig. 1).

The *HLA-G\*0105N* null allele has been described in healthy adults whose own gestations and deliveries were normal (without complications). The detection of individuals who are genetically homozygous for the *HLA-G\*0105N* allele suggests that the *HLA-G* isoforms encoded by this allele possess functions able to compensate for the absence of both the *HLA-G1* and *-G5* proteins and to maintain the immune privileged status of the fetal-maternal interface [14, 15].

Based on the previously mentioned observations and on a previous study showing that selection may have increased the frequency of the *HLA-G\*0105N* allele [16], the goal of the present study was to demonstrate that in the absence of the *HLA-G1*, *-G5*, and *-G4* isoforms, the other *HLA-G* isoforms present in *HLA-G\*0105N* can indeed provide a protective function.

<sup>1</sup>Supported by the Commissariat à l'Énergie Atomique.

<sup>2</sup>Correspondence: Magali Le Discorde, Service de Recherches en Hémato-Immunologie, CEA-DSV-DRM, Institut d'Hématologie, Hôpital Saint-Louis, Paris 75010, France. FAX: 33 1 48 03 19 60; e-mail: teyssier@dsvidf.cea.fr

In the present work, we investigate the structural and functional aspects of *HLA-G\*0105N* proteins. We constructed the *HLA-G\*0105N* null allele genomic DNA in the *pcDNA3.1* expression vector, which enabled us to study the expression and function of its proteins. The aim of this work was to acquire more data on spliced HLA-G isoforms in general and to understand how they could compensate for the absence of full-length HLA-G proteins.

## MATERIALS AND METHODS

### *In Vitro Site-Directed Mutagenesis*

*In vitro* site-directed mutagenesis was carried out using the Stratagene QuickChange XL site-directed mutagenesis kit, which allows site-specific mutation in double-stranded plasmids. The plasmid DNA template (50 ng) *HLA-G\*010102-pcDNA3.1*, isolated from the *dam<sup>+</sup> JM109 Escherichia coli* strain, was replicated by PfuTurbo DNA polymerase (2.5 U) using two synthetic primers, G.Null S and G.Null AS (125 ng each), consisting of 15 bases on both sides of the  $\Delta C$  mutation. The oligonucleotide primers, each complementary to opposite strands of the *HLA-G\*010102* insert, were extended during temperature cycling (95°C for 1 min; 18 cycles at 95°C for 50 sec, 60°C for 50 sec, 68°C for 15 min) and terminated by 7 min at 68°C. Following temperature cycling, amplification reactions were cooled and digested for 1 h at 37°C using *Dpn I* restriction enzyme to eliminate the nonmutated parental supercoiled double-stranded DNA. At this step, genomic *HLA-G\*010102-pcDNA3.1* was replaced by genomic *HLA-G\*0105N-pcDNA3.1*. The mutated DNA was then transformed in XL10-Gold ultracompetent cells.

### *Cell Lines, Transfection, and Cultures*

Melanoma M8 (kindly provided by F. Jotereau, INSERM U211, Nantes, France) and histiocytic lymphoma U937 (American Type Culture Collection) human cell lines are HLA-class II negative; HLA-A, -B, -C, and -E positive (HLA-A1, -A2, -B12, and B40/male); but HLA-G negative. The NKL NK cell line (kindly provided by E.H. Weiss, Department of Anthropology and Human Genetics, Munich, Germany) [17, 18] and the YT2C2 NK [19, 20] subclone (kindly provided by P. Paul, Hospital Saint-Louis, Paris, France) have been previously described. All cells were maintained in RPMI 1640 plus Glutamax medium supplemented with 1  $\mu$ g/ml gentamicin, fungizone, and 20% inactivated fetal calf serum. NKL cells were concurrently cultured in the presence of 50 U/ml of interleukin-2 (IL2) (Sigma-Aldrich, St. Quentin Fallavier, France) and boosted to 100 U/ml IL2 the day before the cytotoxicity assays. M8 and U937 transfectants were selected using 200 mU/ml hygromycin B (Invitrogen, Cergy Pontoise, France). *HLA-G\*0105N* inserted into the *pcDNA3.1/Hygro (-)* expression vector was transfected into M8 and U937 cells. We worked with bulk transfectants since absence of the HLA-G1 membrane-bound isoform prevents the selection of positive cloned cells by cell sorting. The other transfectants, M8-HLA-G1 through -G4 and M8-*HLA-G\*010102*, have been previously characterized [21, 22].

### *Classical and Real-Time RT-PCR Analysis*

Reverse transcription-polymerase chain reaction (RT-PCR) was carried out to validate *HLA-G* expression and to determine which isoforms were expressed in our new M8-*HLA-G\*0105N* cell line. Total RNA was purified by RNA-WIZ reagent (Ambion, Huntingdon, U.K.) according to the manufacturer's instructions. The cDNA was synthesized on 5  $\mu$ g RNA using oligo (dT) primers (Invitrogen) and MMLV-reverse transcriptase (Life Technologies, Cergy-Pontoise, France) for 1 h at 42°C. Heating for 8 min at 95°C stopped the reaction.

Real-time PCR (ABI PRISM 7000 SDS) was used to determine the quantities of *HLA-G* transcripts in transfected cell lines. Duplex PCR was carried out for 40 amplification rounds in the presence of TaqMan Universal PCR Master Mix, using the TaqMan Assay Reagent and GAPDH as an endogenous control (probe with VIC reporter and TAMRA quencher), *HLA-G*-specific probe (200 nM, FAM reporter, and TAMRA quencher), and *HLA-G*-specific primers (300 mM, Q biogen).

Classical PCR was carried out according to the 13th HLA Workshop [21] procedure, using a Perkin-Elmer DNA thermal cycler in a total volume of 100  $\mu$ l containing 2  $\mu$ l of the RT reaction product, 200  $\mu$ M of each *dNTP* (Invitrogen), 100 ng of each primer, 10  $\mu$ l of 10 $\times$  Taq buffer, and 2.5 U of Taq polymerase (Applied Biosystems, Courtabœuf, France). All *HLA-G* isoforms were amplified with G.257F/G.1004R primers, *HLA-*

G2 with G.-3/G.1216 primers, *HLA-G3* with G.-3-4/G.1216 primers, and *HLA-G5* with G.257/G.i4. These PCR products were revealed by radioactive hybridization with G.927 oligonucleotide, except for *HLA-G5* amplification, which was revealed using the G.R probe.

### *Vector Construction and Oligonucleotides*

*In vitro* site-directed mutagenesis was accomplished from the genomic *HLA-G\*010102* sequence inserted into *pcDNA3.1/Hygro (-)* expression vector (Invitrogen). The *HLA-G\*010102* sequence begins in the promoter at the *XbaI* site (460 nucleotides upstream from ATG) and continues to the *EcoRV* site in the 3'UT [21]. The cytosine deletion was introduced using two primers, G.Null S (5'-GCCCTGAACGAGGACTGCGCTCCTGGACCG) and G.Null AS (5'-CGGTCCAGGAGCGCAGTCCTCGTTCAGGGC).

Real-time PCR was carried out with the G.948 forward primer located in exon 5 (5'-CTGGTTGTCCTTGACGCTGTAG), the G.1002 reverse primer located in both sides of exon 5 and exon 6 (5'-CCTTTTCAATCTGAGCTCTTCTTCT), the G.971F internal probe (5'-CACTGGAGCTGCGTCTGCTGCT), the FAM reporter, and the TAMRA quencher.

For classical PCR, all *HLA-G* transcripts were amplified from exon 2 by G.257 forward (5'-GGAAGAGGAGACACGGAACA) to exon 5/6 by G.1004 reverse (5'-CCTTTTCAATCTGAGCTCTTCTTT). *HLA-G2* and *HLA-G3* transcripts were amplified, respectively, from exons 2/4 by G.-3 forward (5'-ACCAGAGCGAGGCCAACCCC) and from exons 2/5 by G.-3-4 forward (5'-ACCAGAGCGAGGCCAACGAG) to the 3'UT sequence by G.1216 reverse (5'-GACGGAGACATCCCAGCCCC). Transcripts corresponding to spliced forms were from exon 2 by G.257 up to intron 4 by G.i4 reverse (5'-CTGGGAAAGGAGGTGAAGGT). Internal probes were localized in exon 5 with G.927 reverse (5'-CCAGCAACGATACCCATGAT) or in exon 2 with G.R (5'-GGTCTGCAGGTTCACTTCTGTC).

### *Monoclonal Antibodies*

The following murine antibodies were used: 4H84, IgG1 recognizing  $\alpha 1$  domain common to all HLA-G isoforms (provided by Michael McMaster [23]); MEM-G/04, IgG1 recognizing the denatured form of HLA-G1, -G2, -G5, and -G6 (provided by Vaclav Horejsi, Prague, Czech Republic); MEM-G/09, IgG1 recognizing the HLA-G molecules associated with beta2-microglobulin (HLA-G1 and -G5) [24] (Exbio, Prague, Czech Republic); 5A6G7, IgG1 antibody against intron 4 of soluble HLA-G5 and -G6 isoforms made in our laboratory [25].

### *Immunocytochemical Analysis*

Cells were grown on LabTech slides (Dutscher, Brumath, France), fixed in acetone, and stored at -80°C until evaluation of the expression of *HLA-G* and class I protein by immunohistochemistry, using the Ultra-Tech HRP Streptavidin-Biotin Universal Detection System (Immunotech Coulter, Roissy, France) as previously described [12]. Briefly, endogenous peroxidase was blocked with 3% H<sub>2</sub>O<sub>2</sub>, and antibodies were diluted in buffer containing 0.1% saponin.

### *Flow Cytometry Assays*

The flow cytometry technique was used to analyze cell-surface *HLA-G* protein expression. Transfected cells were phenotyped according to standard procedure by incubating them with the primary anti-*HLA-G* antibody MEM-G/09 in PBS 2% heat-inactivated fetal calf serum for 30 min at 4°C. Cells were subsequently stained with an F(ab')<sub>2</sub> goat anti-mouse IgG antibody conjugated with phycoerythrin (Immunotech Coulter).

### *Cell-Surface Protein Biotinylation*

Cell-surface proteins of viable M8 transfected cells were biotinylated as previously described [4]. Cells were first washed twice with PBS and treated with sulfo-NHS-LC-biotin (Pierce, Rockford, IL; 200  $\mu$ g/ml of PBS) for 4 min at room temperature. The cells were washed twice with PBS, treated with 50 mM glycine for 5 min, and again washed twice with PBS. Dead or dying (nonadherent) cells were removed by washing. Cells were then detached and collected in tubes, then washed in PBS five times at 4°C. Cells in the last pellet were readied for analysis by immunoprecipitation.

### *Immunoprecipitation of Cell-Surface Proteins*

Cells were lysed in 1 ml of lysis buffer (0.5% CHAPS, 50 mM Tris-HCl). After centrifugation at 14000 rpm for 30 min at 4°C, biotinylated

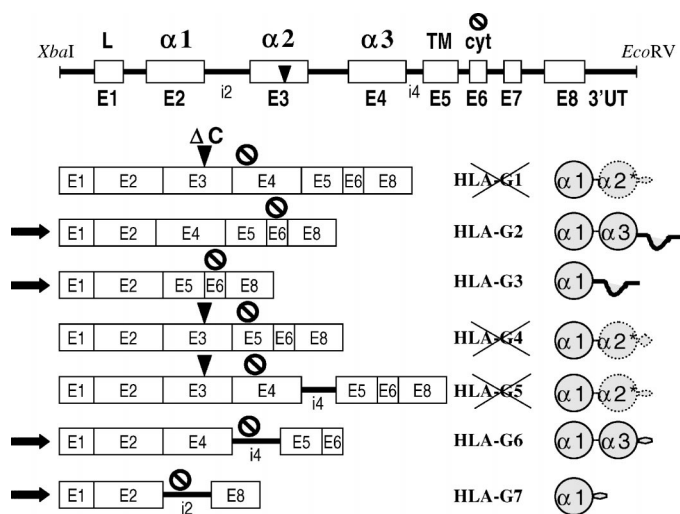

FIG. 1. Schematic drawing of the *XbaI* - *EcoRV* genomic DNA sequence of *HLA-G*. The *HLA-G\*0105N* sequence corresponds to that of *HLA-G\*010102*, except for the deletion of cytosine, indicated by an arrow in exon 3 ( $\Delta C$ ). The *HLA-G* gene consists of eight exons (E1–E8), corresponding, respectively, to the peptide leader domains (L),  $\alpha 1$ ,  $\alpha 2$ , and  $\alpha 3$ , the transmembrane domain (TM), and the intracytoplasmic domain (cyt). Exons were separated by introns (i). The *HLA-G\*0105N* gene putatively encodes the membrane-bound *HLA-G2*, *-G3*, and soluble *HLA-G6* and *-G7* proteins, in all of which exon 3, which contains the deletion, is deleted. *HLA-G1*, *-G4*, and *-G5* might consist of the leader peptide, the complete  $\alpha 1$  domain, the first half of the  $\alpha 2$  domain, and a premature end in the following exon.

proteins were precipitated from the supernatant by precipitation with 100  $\mu$ l of 50% streptavidin-agarose beads (Bio-Rad, Marnes la Coquette, France) for 1 h at 4°C. Nonbiotinylated proteins in the supernatant of the first centrifugation were taken to be the intracellular material and retained for Western blot analysis. Bead-bound biotinylated proteins were washed in three buffers (buffer 1: 0.1% CHAPS, 150 mM NaCl 40 mM, 0.05% Na<sub>3</sub>S, and 20 mM Tris-HCl pH 7.5; buffer 2: 0.05% CHAPS, 0.1% SDS, 300 mM NaCl, and 10 mM Tris-HCl pH 8; buffer 3: 0.1% CHAPS and 20 mM Tris-HCl pH 7.4). Biotinylated proteins were then resuspended in 60  $\mu$ l Laemmli buffer 2 $\times$ , and 40  $\mu$ l of the nonbiotinylated proteins were mixed with 20  $\mu$ l Laemmli buffer 6 $\times$ . These two samples were boiled for 5 min and analyzed by Western blot.

### Deglycosylation Treatment

Forty microliters of M8 transfectants lysed in 0.5% CHAPS; 50 mM Tris-HCl pH 7.5 were deglycosylated, using peptide-N-glycosidase F from flavobacterium, according to Sigma's instructions (Sigma-Aldrich). The deglycosylated proteins were examined by Western blot analysis.

### Western Blot Analysis

Proteins were loaded and separated on 12% Tris-glycine-SDS polyacrylamide gels and electroblotted to nitrocellulose membranes (Hybond, Amersham Biosciences, Orsay, France). The membranes were probed with an *HLA-G*-specific antibody (4H84, MEM-G/04), then revealed with peroxidase-conjugated sheep anti-mouse IgG Ab (Sigma-Aldrich). Western blots were developed by chemiluminescence (Amersham).

### Cytotoxicity Assays

The cytolytic activity of the NKL cells and YT2C2 cells used as effectors (E) was assessed in 4-h <sup>51</sup>Cr release assays in which the effector cells were mixed with  $5 \times 10^3$  <sup>51</sup>Cr-labeled transfected-M8 or U937 (T) (100  $\mu$ Ci <sup>51</sup>Cr sodium chromate; 1 Ci = 37 Gbq; Amersham) at various E:T ratios, as previously described [4]. The percentage specific lysis was calculated as follows: % specific lysis = [(cpm experimental - cpm spontaneous release)/(cpm maximum release - cpm spontaneous release)]  $\times$  100. Spontaneous release was determined by incubation of labeled target cells in RPMI 1640 medium supplemented with 10% FCS. Maximum release was determined by solubilizing target cells in 0.1 N HCl. In all experiments, spontaneous release was less than 10% of maximum release.

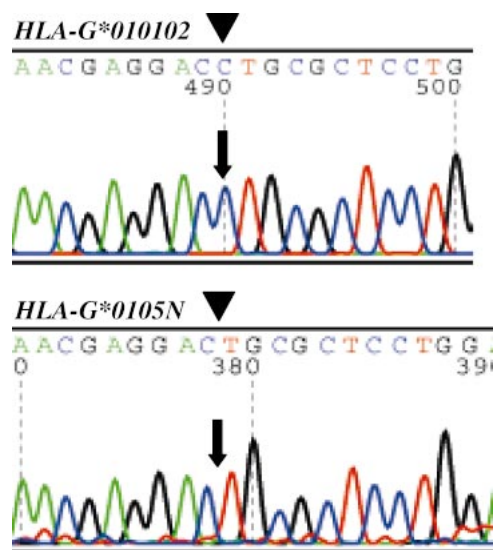

FIG. 2. DNA sequencing electropherogram of the *HLA-G\*010102* allele (A) and before deletion of the cytosine in exon 3 and after directed mutagenesis, yielding the *HLA-G\*0105N* allele (B).

## RESULTS

### Construction of *HLA-G\*0105N* Null Allele Genomic DNA

To study proteins encoded by the *HLA-G* null allele, we generated a DNA sequence identical to *HLA-G\*0105N* in the *pcDNA 3.1* expression vector. In vitro site-directed mutagenesis of *HLA-G\*010102* genomic DNA allowed us to delete the cytosine at position 815 from ATG (exon 1), yielding the genomic DNA of the *HLA-G\*0105N* allele. We used the *HLA-G\*010102* rather than the *HLA-G\*010101* reference sequence since *HLA-G\*010102* and *-G\*0105N* have identical DNA sequences with the exception of the cytosine deletion at codon 130 [14]. The *XbaI-EcoRV HLA-G\*010102* fragment linked into the *pcDNA3.1* vector used as the template is represented in Figure 1, and the electropherogram of DNA sequences before and after directed mutagenesis demonstrating deletion of the cytosine in the newly synthesized DNA is shown Figure 2, the remaining sequence being identical. The genomic *HLA-G\*0105N* DNA presented a deletion at codon 130 (CTG  $\rightarrow$  TGC), which generated a stop codon 171 nucleotides further on at codon 189 (GTG  $\rightarrow$  TGA) in exon 4 or 495 nucleotides further on at codon 297 (GTA  $\rightarrow$  TAG) in exon 5. At this step, we had obtained a copy of the *HLA-G\*0105N* allele of 3932 nucleotides, beginning 460 bp upstream from exon 1 and ending 541 bp downstream from exon 8.

### Pattern of mRNA Expression in *HLA-G\*0105N*-Transfected Cells

Real-time RT-PCR was carried out on mRNA prepared from M8 cells transfected with both genomic *HLA-G\*0105N* and *HLA-G\*010102* as well as mRNA from JEG-3 cells (Fig. 3). These results revealed that higher levels of *HLA-G* transcripts were produced in both M8-*HLA-G\*0105N* and M8-*HLA-G\*010102* than in the JEG-3 cells (JEG-3 is taken as a reference since it is one of the rare cell lines that constitutively expresses *HLA-G* proteins). *HLA-G* transcript levels measured in the M8-transfected cells varied according to the particular *HLA-G* sequence

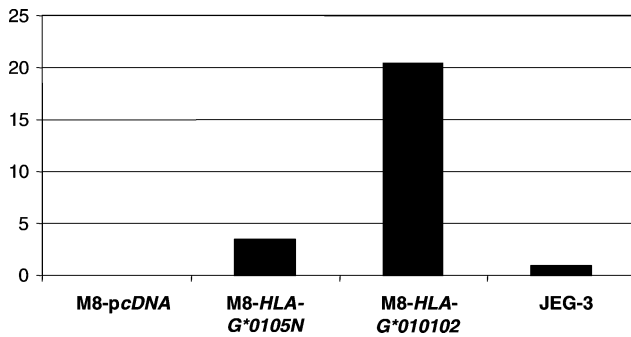

FIG. 3. Results of real-time reverse transcription-polymerase chain reaction (RT-PCR) analysis showing relative quantities of HLA-G transcripts in M8-HLA-G\*0105N, M8-HLA-G\*010102, and M8-pcDNA compared with that of JEG-3 cells (assigned a value of 1).

transfected, lower levels being found for M8-HLA-G\*0105N than for M8-HLA-G\*010102 (Fig. 4). To determine the mRNA pattern of M8-HLA-G\*0105N, we carried out HLA-G-specific RT-PCR and radioactive hybridization reactions comparing M8-HLA-G\*0105N with M8-HLA-G\*010102. The specific G.927 probe, located in exon 5, was used to hybridize all PCR products except those of G.257/G.i4, which were hybridized using the G.R probe, located in exon 2. The G.257F/G.1004R primers disclosed four bands, corresponding to the principal mRNAs: HLA-G5 (889 bp), -G1 (767 bp), -G2 and -G4 (491 bp), and -G3 (215 bp) (Fig. 4a). HLA-G2 was amplified using the G.-3/G.1216 primers (627 bp) (Fig. 4b) and HLA-G3 with the G.-3-4/G.1216 primers (341 bp) (Fig. 4c). The G.257/G.i4 primers allowed amplification of HLA-G5 (765 bp) and HLA-G6 (489 bp) (Fig. 4d). We thus confirmed that all HLA-G mRNA had been transcribed in M8-HLA-G\*0105N cell line.

#### HLA-G Proteins Are Translated in HLA-G\*0105N-Transfected Cells

The proteins synthesized by the HLA-G\*0105N allele have been deduced from its nucleotide sequence [14]. According to these authors, HLA-G isoform amino-acid sequences deduced from the HLA-G\*0105N DNA sequence would yield the complete membrane-bound HLA-G2 and -G3, as well as the soluble HLA-G6 and -G7 isoforms.

HLA-G1, -G4, and -G5 undergo a reading frame shift, and the corresponding proteins are prematurely truncated in the null allele.

To detect HLA-G proteins that were expressed by M8-HLA-G\*0105N in our experiments, we carried out immunocytochemistry assays on permeabilized cells. As may be seen in Figure 5, M8-HLA-G\*0105N cells were positively stained by 4H84, an antibody that targets the  $\alpha$ 1 domain present in all HLA-G isoforms (Fig. 5b); by MEM-G/04, an antibody that recognizes the  $\alpha$ 3 domain (Fig. 5f); and by 5A6G7, an antisoluble antibody against HLA-G5 and -G6) (Fig. 5n). As expected, the presence of HLA-G1 or -G5 was not detected in M8-HLA-G\*0105N with the MEM-G/09 antibody (Fig. 5j). All these anti-HLA-G antibodies had positively bound M8-HLA-G\*010102, a genomic HLA-G sequence in which HLA-G1 is predominantly expressed, but one would expect the other isoforms to be present (Fig. 5, c, g, k, and o). The HLA-G2 isoform was stained by both the 4H84 and the MEM-G/04 antibodies in M8-HLA-G2 cells (Fig. 5, d and h). Collectively, these immunocytochemical analyses revealed the presence of HLA-G2 and -G6 isoforms in M8-HLA-G\*0105N.

Using flow cytometry and the MEM-G/09 antibody, we confirmed that whereas M8-HLA-G\*0105N did not express HLA-G1 protein at the cell surface, M8-HLA-G\*010102 did (Fig. 6). Because of the unavailability of antibodies able to bind HLA-G2 and HLA-G3 in the flow cytometry assay, we were unable to identify these membrane-bound isoforms, which could have been translated by M8-HLA-G\*0105N cells.

#### Characterization of HLA-G Proteins in HLA-G\*0105N-Transfected Cells

In succeeding experiments, we attempted to characterize the HLA-G proteins that had been translated in M8-HLA-G\*0105N cells, using M8-HLA-G\*010102 and M8-HLA-G2 as positive controls. We used immunoprecipitation of biotinylated cell-surface proteins to achieve separation of membrane-bound and intracytoplasmic proteins. The results revealed membrane-bound HLA-G2 protein on M8-HLA-G2 (bands at 30 and 27 kDa) and HLA-G1 protein on M8-HLA-G\*010102 (one band at 43 kDa), but no HLA-G molecules could be detected in M8-HLA-G\*0105N by this method (Fig. 7A). However, study of the intracellular pro-

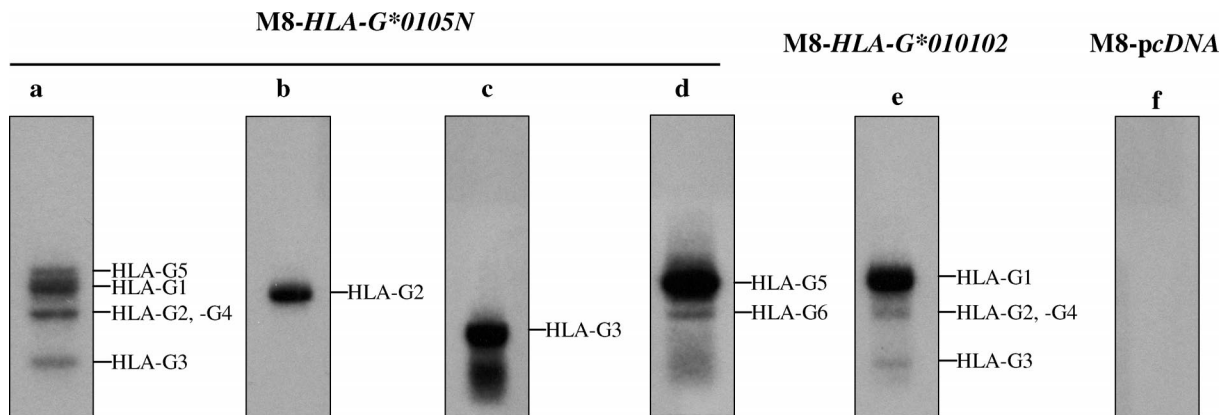
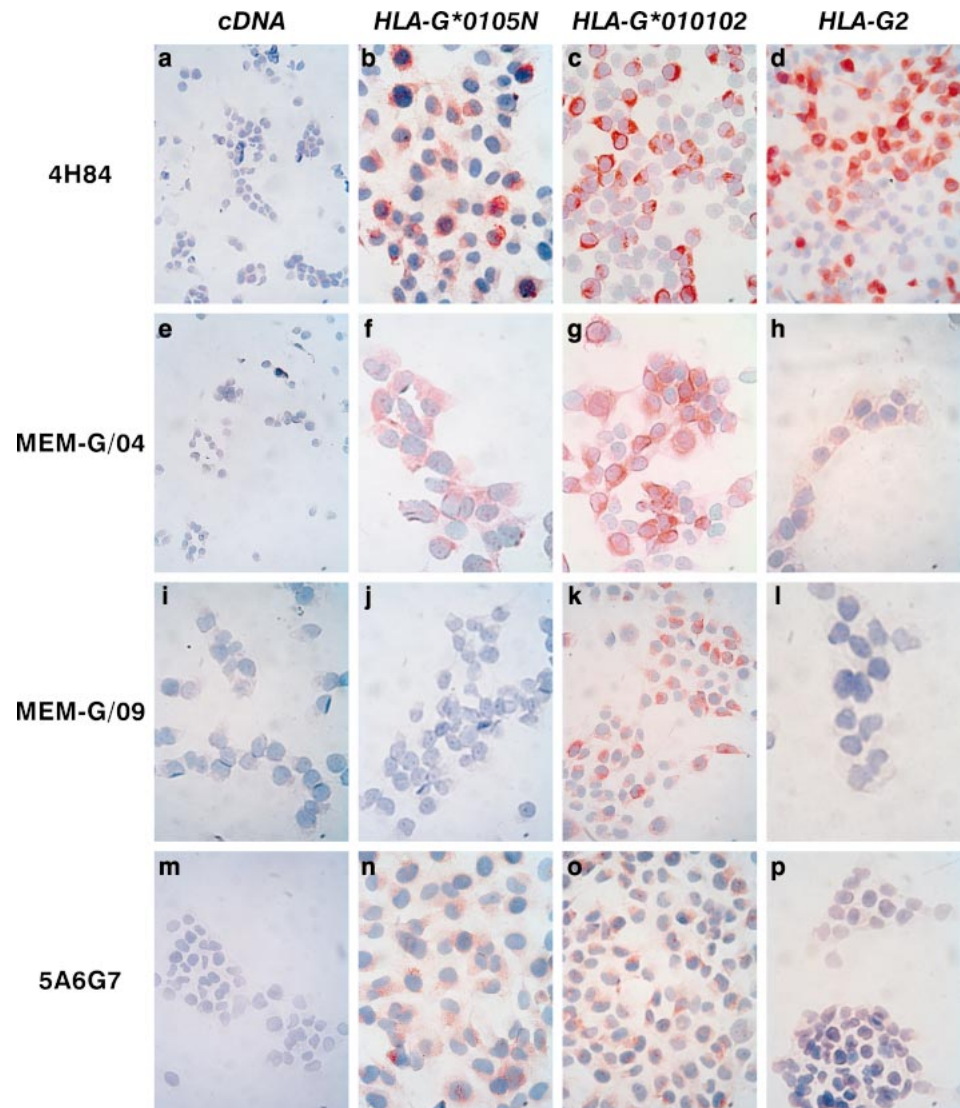

FIG. 4. Reverse transcription-polymerase chain reaction (RT-PCR) and Southern blot characterization of HLA-G mRNA isoforms in M8-HLA-G\*0105N (a-d). PCR amplifications are carried out using pan-HLA-G primers G.257F/G.1004R (a, e, f); primer set G.-3F/G.1216R, specific for HLA-G2 (b); primer set G.-3-4F/G.1216R, specific for HLA-G3 (c); and primer set G.257F / G.i4R, specific for both HLA-G5 and -G6 (d). M8-HLA-G\*010102 (e) and M8-pcDNA (f) are, respectively, the positive and negative controls. Southern blots a, b, c, e, and f were hybridized with G.927R (exon 5), and blot d was hybridized with G.R (exon 2) probes.

FIG. 5. Immunocytostaining of M8 transfectants with anti-HLA-G antibodies 4H84 (a–d), MEM-G/04 (e–h), MEM-G/09 (i–l), and 5A6G7 (m–p). All antibodies are negative in the control M8-*pcDNA* (a, e, i, m). The anti-HLA-G1, -G2, -G5, -G6 antibody MEM-G/04 is positive in all *HLA-G* transfected cells (f–h). The anti-HLA-G1, -G5 antibody MEM-G/09 stained M8-*HLA-G\*010102* (k) but not M8-*HLA-G\*0105N* (j) or M8-*HLA-G2* (l). The anti-HLA-G5, -G6 antibody 5A6G7 stained M8-*HLA-G\*0105N* (n) and M8-*HLA-G\*010102* (o) but not M8-*HLA-G2* (p). Original magnification  $\times 200$ .



teins revealed the presence of HLA-G isoforms. We obtained three bands, one at 30 kDa and one at 27 kDa, that were identical to those produced by M8-*HLA-G2*, plus one located above them, at 35 kDa, that has never been characterized (Fig. 7B). To determine whether this latter band corresponded to hyperglycosylated HLA-G2, we treated the M8-*HLA-G\*0105N* cells with PNGase F, an enzyme that catalyzes the removal of N-linked oligosaccharide chains from glycoproteins (Fig. 8). This enzyme treatment re-

vealed a smaller band just below that of the mature protein, corresponding to the deglycosylated protein. This finding indicated that M8-*HLA-G\*0105N* had indeed translated some glycoproteins, but the molecular weight obtained for the 35-kDa protein did not correspond to any known HLA-G isoform. Staining with 4H84 and MEM-G/04 antibodies allowed us to determine that at least the  $\alpha 1$  and  $\alpha 3$  domains were present in this protein, which remains to be characterized.

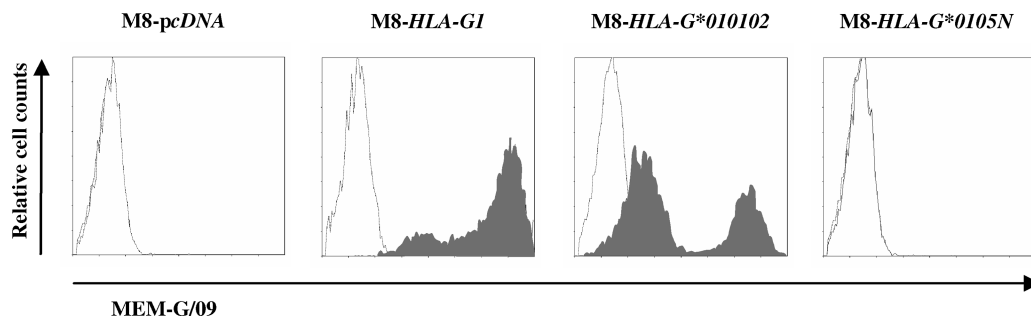

FIG. 6. Detection by flow cytometry analysis of the HLA-G1 isoform on M8-*HLA-G\*010102* but not on M8-*HLA-G\*0105N*. Cells were labeled by indirect immunofluorescence with MEM-G/09 mAb (bold profiles) and an isotope-matched control Ab (light profiles). M8-*pcDNA* and M8-*HLA-G1* cells were used as controls.

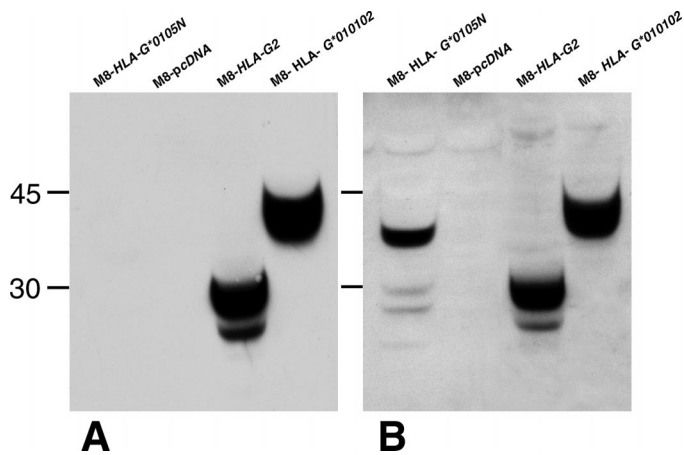

FIG. 7. The *HLA-G\*0105N* allele produced intracytoplasmic HLA-G proteins. Cell-surface proteins are biotinylated and separated from the nonbiotinylated inside proteins. Immunostaining with both 4H84 and MEM-G/04 mAbs revealed the intracellular presence of HLA-G proteins (B) but not on the cell surface (A). The mechanism providing the additional smaller band for HLA-G2 (i.e., band at 27 kDa) remains to be determined.

#### *HLA-G\*0105N*-Transfected Cells Are Protected from NK Cell-Mediated Cytotoxicity

To determine whether the *HLA-G\*0105N* allele translated functional HLA-G isoforms, cytotoxic assays were carried out confronting either the NKL or the YT2C2 cell line [17, 19] used as the effector with the M8 or U937 transfectant cells used as the target (Fig. 9). When stimulated with interleukin-2, the NKL human NK cell line retained most of the original features of NK cells, including very similar proliferative responses and natural killing function. While YT2C2 express only KIR2DL4, NKL cells express both ILT2 and KIR2DL4 inhibitory receptors [18, 26], which are implicated in the NK-cell cytotoxicity pathways, by binding to HLA-G molecules. The lytic activity of NKL against M8-*HLA-G\*0105N* was compared with its lytic activity against M8-*HLA-G\*010102* cells, which at least express HLA-G1, as well as against M8-*HLA-G2* cells, which express only the HLA-G2 isoform, and against M8-*pcDNA*, used as the HLA-G-negative control. Cytotoxicity experiments showed that in addition to M8-*HLA-G2*, both genomic M8-*HLA-G\*0105N* and M8-*HLA-G\*010102* were protected from NKL lysis. Lysis of M8-transfectants was reduced by 50% compared with that of the M8-*pcDNA* control cell line. Inhibition of cytotoxicity was also obtained using YT2C2 cells, which only express the HLA-G-specific receptor against U937-transfectants.

#### DISCUSSION

After our study of the tolerogenic role of HLA-G in maternal-fetal tolerance [27, 28], we designed experiments to identify the structural and functional characteristics of proteins generated by the *HLA-G\*0105N* allele. First, we used site-directed mutagenesis to construct the *HLA-G\*0105N* from the nucleotide sequence of *HLA-G\*010102* and transfected it into the M8 human cell line. Then we characterized the transcripts and proteins generated by the *HLA-G\*0105N* gene before analyzing the functional capacity of the isoforms produced.

Although the deletion of one base in exon 3 of *HLA-G\*0105N* disrupts the reading frame, it should have no effect on transcription of the primary transcript or on its al-

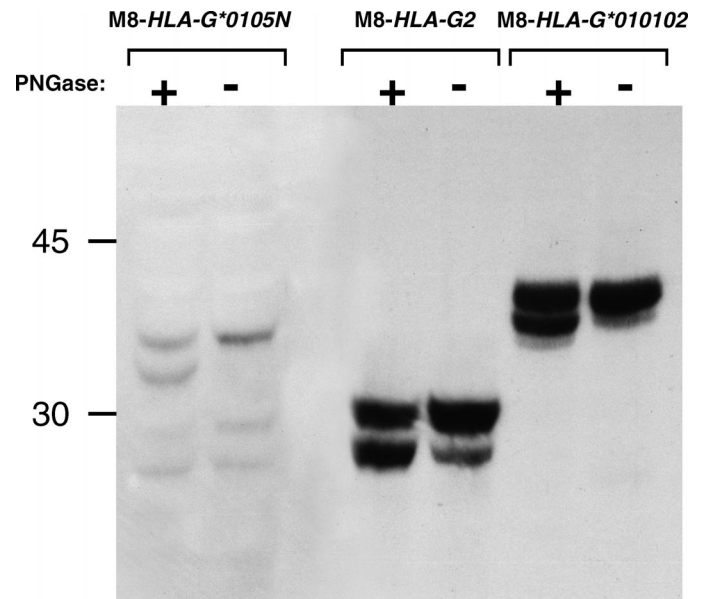

FIG. 8. *HLA-G\*0105N* isoforms are translated as glycoproteins. Lysate from M8 transfectants were treated with PNGase F allowing visualization of mature and deglycosylated proteins. Western blots were stained with 4H84 mAb. PNGase F treatment removed oligosaccharides from the glycoproteins. Revelation of two bands (glycosylated and not) indicated that this treatment was not complete. M8-*HLA-G\*0105N* presents two weak bands, at 30 and 27 kDa (representing glycosylated and nonglycosylated HLA-G2) and one unidentified band at 35 kDa, which migrated at 31 kDa after PNGase F treatment.

ternative splicing [14]. Indeed, in our RT-PCR analysis, the *HLA-G* mRNA profile was the same in both M8-*HLA-G\*0105N*- and M8-*HLA-G\*010102*-transfected cells, indicating the presence of all *HLA-G* mRNA transcripts normally found. Thus, deletion of the cytosine in codon 130 did not block the transcription and splicing mechanisms in the null allele. Nevertheless, real-time and classical RT-PCR showed that *HLA-G* mRNA levels were lower in M8-*HLA-G\*0105N* than in M8-*HLA-G\*010102* cells, and classical PCR revealed that the *HLA-G1/HLA-G2* mRNA ratio was lower in M8-*HLA-G\*0105N* than in M8-*HLA-G\*010102*. This discrepancy in the expression level of HLA-G genotypes and isoforms has already been reported for alleles other than the null allele in pathological pregnancies in which altered *HLA-G* transcription was associated with certain *HLA-G* genotypes [29, 30] as well as in a study of the role of *HLA-G* alleles in determining the soluble HLA-G protein plasma level [31]. Another explanation is that nonsense-mediated decay, a eukaryotic regulatory process that degrades mRNA with premature termination codons, could be responsible for the higher degradation of HLA-G1 transcripts in cells expressing the null allele compared with other alleles [32].

Furthermore, the higher levels of mRNA in transfected cells compared with JEG-3 cells could be explained by the fact that 1) in transfected cells, *HLA-G* is ligated in the *pcDNA3.1* plasmid, which possesses the CMV promoter and is thus able to influence and perhaps increase *HLA-G* mRNA expression, and 2) *HLA-G\*010102* has been described as a much higher “HLA-G secreting” allele than either *HLA-G\*0105N* or *HLA-G\*010103* (carried by JEG-3 cells [33]) [31].

Finally, although mRNA levels are higher in M8-transfected cells than in JEG-3 cells, this cannot be correlated with either the quality or the quantity of the corresponding

FIG. 9. M8-*HLA-G\*0105N* is able to inhibit NKL cell cytolytic activity. Chromium release assays were carried out using M8- or U937-pcDNA, M8- or U937-*HLA-G\*0105N*, M8- or U937-*HLA-G\*010102*, or M8-*HLA-G2* as target cells and NKL cell line (A) or YT2C2 cell line (B) as effectors. Results are expressed as the percentage lysis recorded in a 4-h <sup>51</sup>Cr-release assay. Values represent means of triplicate  $\pm$  SD. This experiment is representative of five distinct experiments.

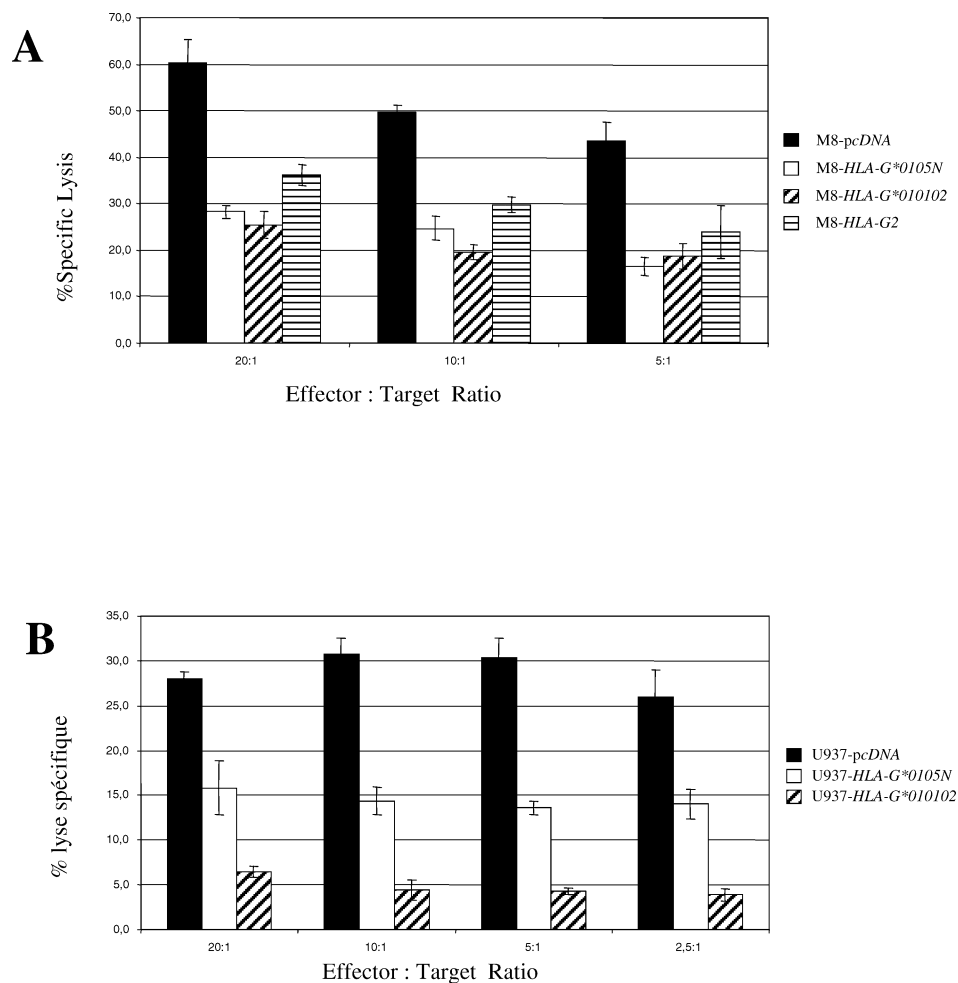

translated isoform proteins. Thus, the mRNA level is lower in M8-*HLA-G\*0105N* cells than in M8-*HLA-G\*010102* cells (Fig. 3), and both M8 transfectants are equally protected from NKL-mediated cytotoxicity (Fig. 9A).

Since the presence of *HLA-G* mRNA had been demonstrated in M8-*HLA-G\*0105N*, we also looked for *HLA-G* proteins in it. For this purpose, *HLA-G\*0105N*-transfected cells were immunostained with specific *HLA-G* antibodies targeting either all *HLA-G* proteins or specific isoforms. As expected from the deletion in *HLA-G\*0105N*, neither the *HLA-G1* nor the *HLA-G5* isoform was detected in M8-*HLA-G\*0105N* since these cells were not stained by the MEM-G/09 mAb, which is specific for *HLA-G1* and *HLA-G5*. The absence of *HLA-G5* and of shed *HLA-G1* was confirmed by a specific ELISA (data not shown). Interestingly, the other mAbs that recognized either all *HLA-G* isoforms (4H84), both *HLA-G5* and -G6 (5A6G7), or *HLA-G1*, -G2, -G5, and -G6 (MEM-G/04) were positive in M8-*HLA-G\*0105N*, demonstrating that in the absence of both *HLA-G1* and -G5, other *HLA-G* isoforms are produced. These isoforms may correspond to at least the *HLA-G2* and/or *HLA-G6* proteins. In support of this observation, previous immunohistochemical analyses of placenta homozygous for *HLA-G\*0105N* presented negative staining with an anti-*HLA-G1*, -G5 antibody (87G) and positive staining with an anti-*HLA-G1*, -G2 antibody (15C6) [15]. These results confirm that *HLA-G* proteins are indeed translated in *HLA-G\*0105N* cells.

To further characterize the *HLA-G* isoforms produced by M8-*HLA-G\*0105N* cells, we carried out immunoprecipitation and Western blot experiments.

Under our experimental conditions, proteins at 35 and 30 kDa were detected within such cells but not on the cell surface. However, we cannot exclude that *HLA-G* proteins are secreted by these cells and that they exercise biological effects. To address this point, we carried out experiments aimed at analyzing the role of the *HLA-G* proteins generated by M8-*HLA-G\*0105N* with respect to NK function and tested their capacity to inhibit NK cell lysis.

Considered together, these results demonstrate that non-*HLA-G1*/*-G5* isoforms of the *HLA-G\*0105N* allele participate in the inhibition of NK cells. This inhibition is perhaps not mediated by *HLA-E* or other *HLA* class I molecules, since *HLA-G\*0105N*-transfected cells were protected from lysis by the NK-like clone Y2T2C2. Indeed Y2T2C2 expresses the *HLA-G*-specific receptor KIR2DL4, but not *HLA-A*-, -B-, -C-, and -E-specific KIRs.

The *HLA-G\*0105N* allele is estimated to have appeared 18 000 yr ago, leading to the conclusion that it had been positively selected during evolutionary history [16]. A high incidence of the null allele has notably been reported in Africa [34]. A possible explanation for this selection is that it may be due to the high incidence of intrauterine pathogens among the Africa population, which therefore has to maintain an efficient immune system to eliminate uterine infections [16]. One would expect that the absence of *HLA-G1* and -G5 in *HLA-G\*0105N* individuals would serve to maintain the immunocompetence of maternal NK and T cells at the maternal-fetal interface [15, 16]. Weighing the trade-off between increased risk of miscarriage due to the



absence of HLA-G1 and -G5 but low risk of uterine infection and successful outcome of pregnancy but high risk of womb infection, *HLA-G\*0105N* was selected over HLA-G1, -G5, thus eradicating intrauterine pathogen contamination despite the fact that the null genotype is a contributing factor in spontaneous abortion [35, 36]. Our results suggest that *HLA-G\*0105N* would be of interest for purposes other than merely preventing interactions between HLA-G1, -G5 and inhibitory NK receptors since HLA-G2 has maintained that function. The advantages of the selection of this allele must be further investigated.

The emergence of the *HLA-G\*0105N* homozygous gene is not the only condition under which HLA-G protein expression has been found to be impaired. As for classical HLA-class I molecules, both HLA-G1 and -G5 contain three globular domains associated with  $\beta$ 2m and present peptides. Their conformation renders these HLA molecules TAP and  $\beta$ 2m dependent. Therefore, in TAP- or  $\beta$ 2m-deficient individuals, NK-mediated reactions may still occur, and NK cells may retain the ability to reject allogeneic and autologous HLA-class I-negative cells. However, studies of such individuals showed that HLA-class I-deficient cells remain protected from NK lysis. Notably, there are other situations in which expression of both HLA-G1 and -G5 isoforms would also be altered without negatively affecting the outcome of pregnancy. One example is the survival of homozygous TAP-negative children in whom one would expect HLA-G1/-G5 placental expression to be impaired. Indeed, expression of these two isoforms as a trimolecular  $\alpha$ -chain/ $\beta$ 2m/peptide complex is TAP dependent. In the fetuses of such TAP-negative children, the other HLA-G isoforms, whose expression may be independent of peptide loading via TAP, may substitute for the loss of HLA-G1/-G5, thus contributing to the survival of these fetuses [37].

In another study, functional analyses indicated that TAP<sup>-/-</sup> NK cells were unable to kill autologous class I-negative cells. This inhibition was attributed to an unknown inhibitory receptor capable of binding ligand expressed by targeted autologous class I-negative cells, thereby down-regulating NK cell cytotoxicity [38]. Considered together, these studies suggest that still-unknown mechanisms prevent an attack against autologous normal cells that express insufficient quantities of HLA-class I molecules. Therefore, the HLA-G2, -G3, -G6, and -G7 isoforms, in which cell processing and transport are probably peptide independent, might be candidate molecules to compensate for the loss of HLA class I antigens, including HLA-G1 and -G5. The fact that TAP<sup>-/-</sup> NK cells express an unidentified receptor suggests that this unidentified inhibitory receptor is specific for spliced HLA-G isoforms. These interpretations could be extrapolated to tumor cells, which often present down-regulation of classical and nonclassical HLA class I molecules. Expression of the TAP and  $\beta$ 2m-independent spliced HLA-G isoforms (HLA-G2 through -G7) observed in some tumors may constitute a new escape mechanism from NK cell-mediated lysis [39].

Finally, our study provided information indicating that *HLA-G\*0105N* does not encode the complete HLA-G1 or HLA-G5 isoforms but does encode functional HLA-G proteins able to inhibit NK cell cytotoxicity. Thus, although the biological functions of HLA-G1 and HLA-G5 proteins are abrogated, the other isoforms can assume their roles. Two different effectors were used against M8-transfectant cells: the NK1 and YT2C2 cells. Since NK1 cells expressed ILT2, KIR2DL4, and CD94/NKG2A receptors, lysis of *HLA-G\*0105N* cells could be due to a direct interaction

between HLA-G and ILT2 or KIR2DL4 receptors and/or to an indirect effect through HLA-E (whose surface expression is up-regulated in presence of HLA-G leader peptide) and CD94/NKG2A. Nevertheless, results obtained with the YT2C2 effector cells demonstrate that at least HLA-G proteins expressed by *HLA-G\*0105N* inhibit NK lysis through direct interaction with KIR2DL4. Our results showing that *HLA-G\*0105N* cells retained the capacity to inhibit NK cytotoxicity activity agree with the previously described inhibitory role played by the HLA-G2 and -G3 [4]. In support of a biological role for other HLA-G isoforms than -G1 and -G5, two recent reports found that 1) HLA-G2 and -G6 isoforms are expressed by specific subpopulations of trophoblast cells [40] and that 2) recombinant HLA-G6 induces TGF- $\beta$  production by monocytic lineage cells [41].

Most classical HLA-class I genes are translated into one isoform. Therefore, a mutation in the gene yields a null allele, which results in the disappearance of this HLA molecule. A feature of the HLA-G gene is that it encodes seven isoforms, including some that are not altered in the null genotype (HLA-G2/-G3/-G6/-G7). Thus, *HLA-G\*0105N* could maintain the presence of functional HLA-G proteins. In this respect, it would be important to determine the function of each HLA-G isoform and whether a specific role may be attributed to each of them in pregnancy as well as in tumors and transplants.

## ACKNOWLEDGMENTS

We thank Sylvie Sousa and Déborah Sangrouber for technical assistance, Irène Krawice-Radanne for adapting the photographs, and Noah Hardy for editing the text.

## REFERENCES

- Kovats S, Main EK, Librach C, Stubblebine M, Fisher SJ, DeMars R. A class I antigen, HLA-G, expressed in human trophoblasts. *Science* 1990; 248:220–223.
- Carosella ED, Moreau P, Le Maout J, Le Discorde M, Dausset J, Rouas-Freiss N. HLA-G molecules: from maternal-fetal tolerance to tissue acceptance. *Adv Immunol* 2003; 81:199–252.
- Marchal-Bras-Goncalves R, Rouas-Freiss N, Connan F, Choppin J, Dausset J, Carosella ED, Kirszenbaum M, Guillet J. A soluble HLA-G protein that inhibits natural killer cell-mediated cytotoxicity. *Transplant Proc* 2001; 33:2355–2359.
- Riteau B, Rouas-Freiss N, Menier C, Paul P, Dausset J, Carosella ED. HLA-G2, -G3, and -G4 isoforms expressed as nonmature cell surface glycoproteins inhibit NK and antigen-specific CTL cytotoxicity. *J Immunol* 2001; 166:5018–5026.
- Bainbridge DR, Ellis SA, Sargent IL. HLA-G suppresses proliferation of CD4(+) T-lymphocytes. *J Reprod Immunol* 2000; 48:17–26.
- Lila N, Rouas-Freiss N, Dausset J, Carpentier A, Carosella ED. Soluble HLA-G protein secreted by allo-specific CD4+ T cells suppresses the allo-proliferative response: a CD4+ T cell regulatory mechanism. *Proc Natl Acad Sci U S A* 2001; 98:12150–12155.
- LeMaout J, Krawice-Radanne I, Dausset J, Carosella ED. HLA-G1-expressing antigen-presenting cells induce immunosuppressive CD4+ T cells. *Proc Natl Acad Sci U S A* 2004; 101:7064–7069.
- Fournel S, Aguerre-Girr M, Huc X, Lenfant F, Alam A, Toubert A, Bensussan A, Le Bouteiller P. Cutting edge: soluble HLA-G1 triggers CD95/CD95 ligand-mediated apoptosis in activated CD8+ cells by interacting with CD8. *J Immunol* 2000; 164:6100–6104.
- Contini P, Ghio M, Poggi A, Filaci G, Indiveri F, Ferrone S, Puppo F. Soluble HLA-A, -B, -C, and -G molecules induce apoptosis in T and NK CD8+ cells and inhibit cytotoxic T cell activity through CD8 ligation. *Eur J Immunol* 2003; 33:125–134.
- Ellis SA, Sargent IL, Redman CW, McMichael AJ. Evidence for a novel HLA antigen found on human extravillous trophoblast and a choriocarcinoma cell line. *Immunology* 1986; 59:595–601.
- Crisa L, McMaster MT, Ishii JK, Fisher SJ, Salomon DR. Identification of a thymic epithelial cell subset sharing expression of the class Ib HLA-G molecule with fetal trophoblasts. *J Exp Med* 1997; 186:289–298.

12. Le Discorde M, Moreau P, Sabatier P, Legeais JM, Carosella ED. Expression of HLA-G in human cornea, an immune-privileged tissue. *Hum Immunol* 2003; 64:1039–1044.
13. Castro MJ, Morales P, Catalfamo M, Fernandez-Soria V, Suarez B, Varela P, Perez-Blas M, Alvarez M, Jaraquemada D, Arnaiz-Villena A. Lack of HLA-G soluble isoforms in Graves-Basedow thyrocytes and complete cDNA sequence of the HLA-G\*01012 allele. *Eur J Immunogenet* 1998; 25:311–315.
14. Castro MJ, Morales P, Rojo-Amigo R, Martinez-Laso J, Allende L, Varela P, Garcia-Berciano M, Guillen-Perales J, Arnaiz-Villena A. Homozygous HLA-G\*0105N healthy individuals indicate that membrane-anchored HLA-G1 molecule is not necessary for survival. *Tissue Antigens* 2000; 56:232–239.
15. Ober C, Aldrich C, Rosinsky B, Robertson A, Walker MA, Willadsen S, Verp MS, Geraghty DE, Hunt JS. HLA-G1 protein expression is not essential for fetal survival. *Placenta* 1998; 19:127–132.
16. Aldrich C, Wambebe C, Odama L, Di Rienzo A, Ober C. Linkage disequilibrium and age estimates of a deletion polymorphism (1597DeltaC) in HLA-G suggest non-neutral evolution. *Hum Immunol* 2002; 63:405–412.
17. Robertson MJ, Cochran KJ, Cameron C, Le JM, Tantravahi R, Ritz J. Characterization of a cell line, NKL, derived from an aggressive human natural killer cell leukemia. *Exp Hematol* 1996; 24:406–415.
18. Menier C, Riteau B, Carosella ED, Rouas-Freiss N. MICA triggering signal for NK cell tumor lysis is counteracted by HLA-G1-mediated inhibitory signal. *Int J Cancer* 2002; 100:63–70.
19. Yoneda N, Tatsumi E, Kawano S, Teshigawara K, Oka T, Fukuda M, Yamaguchi N. Detection of Epstein-Barr virus genome in natural-killer-like cell line, YT. *Leukemia* 1992; 6:136–141.
20. Riteau B, Menier C, Khalil-Daher I, Martinozzi S, Pla M, Dausset J, Carosella ED, Rouas-Freiss N. HLA-G1 co-expression boosts the HLA class I-mediated NK lysis inhibition. *Int Immunol* 2001; 13:193–201.
21. Paul P, Rouas-Freiss N, Moreau P, Cabestre FA, Menier C, Khalil-Daher I, Pangault C, Onno M, Fauchet R, Martinez-Laso J, Morales P, Villena AA, Giacomini P, Natali PG, Frumento G, Ferrara GB, McMaster M, Fisher S, Schust D, Ferrone S, Dausset J, Geraghty D, Carosella ED. HLA-G, -E, -F preworkshop: tools and protocols for analysis of non-classical class I genes transcription and protein expression. *Hum Immunol* 2000; 61:1177–1195.
22. Riteau B, Moreau P, Menier C, Khalil-Daher I, Khosrotehrani K, Bras-Goncalves R, Paul P, Dausset J, Rouas-Freiss N, Carosella ED. Characterization of HLA-G1, -G2, -G3, and -G4 isoforms transfected in a human melanoma cell line. *Transplant Proc* 2001; 33:2360–2364.
23. McMaster M, Zhou Y, Shorter S, Kapasi K, Geraghty D, Lim KH, Fisher S. HLA-G isoforms produced by placental cytotrophoblasts and found in amniotic fluid are due to unusual glycosylation. *J Immunol* 1998; 160:5922–5928.
24. Menier C, Saez B, Horejsi V, Martinozzi S, Krawice-Radanne I, Bruel S, Le Danff C, Reboul M, Hilgert I, Rabreau M, Larrad ML, Pla M, Carosella ED, Rouas-Freiss N. Characterization of monoclonal antibodies recognizing HLA-G or HLA-E: new tools to analyze the expression of nonclassical HLA class I molecules. *Hum Immunol* 2003; 64:315–326.
25. Le Rond S, Le Maoult J, Creput C, Menier C, Deschamps M, Le Fric G, Amiot L, Durrbach A, Dausset J, Carosella ED, Rouas-Freiss N. Alloreactive CD4+ and CD8+ T cells express the immunotolerant HLA-G molecule in mixed lymphocyte reactions: in vivo implications in transplanted patients. *Eur J Immunol* 2004; 34:649–660.
26. Saverino D, Fabbi M, Ghiotto F, Merlo A, Bruno S, Zarcone D, Tenca C, Tiso M, Santoro G, Anastasi G, Cosman D, Grossi CE, Ciccone E. The CD85/LIR-1/ILT-2 inhibitory receptor is expressed by all human T lymphocytes and down regulates their functions. *J Immunol* 2000; 65:3742–3755.
27. Rouas-Freiss N, Marchal RE, Kirszenbaum M, Dausset J, Carosella ED. The alpha1 domain of HLA-G1 and HLA-G2 inhibits cytotoxicity induced by natural killer cells: is HLA-G the public ligand for natural killer cell inhibitory receptors? *Proc Natl Acad Sci U S A* 1997; 94:5249–5254.
28. Rabreau M, Rouas-Freiss N, Landi M, Le Danff C, Carosella ED. HLA-G expression in trophoblast cells is independent of embryonic development. *Hum Immunol* 2000; 61:1108–1112.
29. O'Brien M, McCarthy T, Jenkins D, Paul P, Dausset J, Carosella ED, Moreau P. Altered HLA-G transcription in pre-eclampsia is associated with allele specific inheritance: possible role of the HLA-G gene in susceptibility to the disease. *Cell Mol Life Sci* 2001; 58:1943–1949.
30. Hviid TV, Hylenius S, Rorbye C, Nielsen LG. HLA-G allelic variants are associated with differences in the HLA-G mRNA isoform profile and HLA-G mRNA levels. *Immunogenetics* 2003; 55:63–79.
31. Rebmann V, van der Ven K, Passler M, Pfeiffer K, Krebs D, Grosse-Wilde H. Association of soluble HLA-G plasma levels with HLA-G alleles. *Tissue Antigens* 2001; 57:15–21.
32. Stamm S, Ben-Ari S, Rafalska I, Tang Y, Zhang Z, Toiber D, Thanaraj TA, Soreq H. Function of alternative splicing. *Gene* 2005; 344:1–20.
33. Hiby SE, King A, Sharkey A, Loke YW. Molecular studies of trophoblast HLA-G: polymorphism, isoforms, imprinting and expression in preimplantation embryo. *Tissue Antigens* 1999; 53:1–13.
34. Matte C, Lacaille J, Zijenah L, Ward B, Roger M. HLA-G and HLA-E polymorphisms in an indigenous African population. The ZVITAM-BO Study Group. *Hum Immunol* 2000; 61:1150–1156.
35. Aldrich CL, Stephenson MD, Karrison T, Odem RR, Branch DW, Scott JR, Schreiber JR, Ober C. HLA-G genotypes and pregnancy outcome in couples with unexplained recurrent miscarriage. *Mol Hum Reprod* 2001; 7:1167–1172.
36. Pfeiffer KA, Fimmers R, Engels G, van der Ven H, van der Ven K. The HLA-G genotype is potentially associated with idiopathic recurrent spontaneous abortion. *Mol Hum Reprod* 2001; 7:373–378.
37. de la Salle H, Hanau D, Fricker D, Urlacher A, Kelly A, Salamero J, Powis SH, Donato L, Bausinger H, Laforet M, Jeras M, Spohner D, Bieber T, Falkenrodt A, Cazanave J-P, Trowsdale J, Tongio MM. Homozygous human TAP peptide transporter mutation in HLA class I deficiency. *Science* 1994; 265:237–241.
38. Vitale M, Zimmer J, Castriconi R, Hanau D, Donato L, Bottino C, Moretta L, de la Salle H, Moretta A. Analysis of natural killer cells in TAP2-deficient patients: expression of functional triggering receptors and evidence for the existence of inhibitory receptor(s) that prevent lysis of normal autologous cells. *Blood* 2002; 99:1723–1729.
39. Tajima A, Tanaka T, Ebata T, Takeda K, Kawasaki A, Kelly JM, Darcy PK, Vance RE, Raulet DH, Kinoshita K, Okumura K, Smyth MJ, Yagita H. Blastocyst MHC, a putative murine homologue of HLA-G, protects TAP-deficient tumor cells from natural killer cell-mediated rejection in vivo. *J Immunol* 2003; 171:1715–1721.
40. Morales PJ, Pace JL, Platt JS, Phillips TA, Morgan K, Fazleabas AT, Hunt JS. Placental cell expression of HLA-G2 isoforms is limited to the invasive trophoblast phenotype. *J Immunol* 2003; 171:6215–6224.
41. McIntire RH, Morales PJ, Petroff MG, Colonna M, Hunt JS. Recombinant HLA-G5 and -G6 drive U937 myelomonocytic cell production of TGF- $\beta$ 1. *J Leukoc Biol* 2004; 76:1220–1228.